

EW500

FACCIATA CONTINUA
CURTAIN WALL

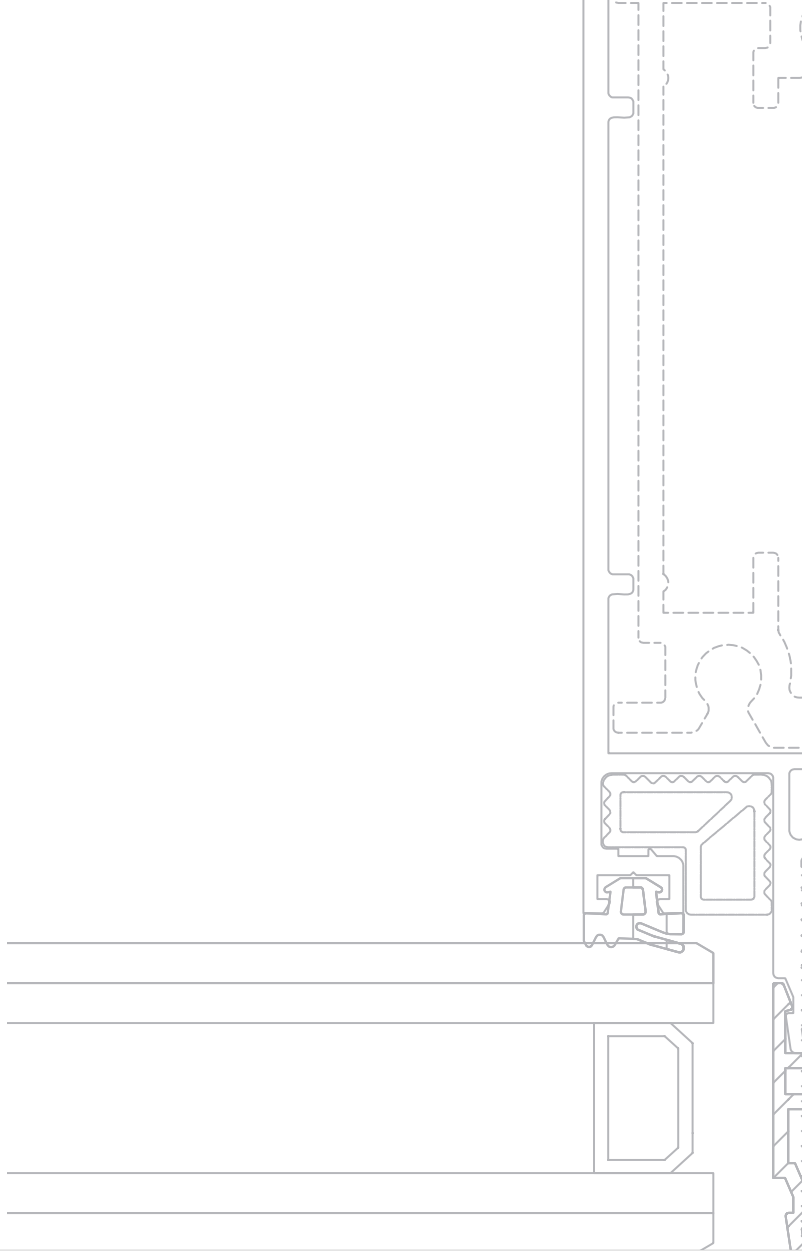

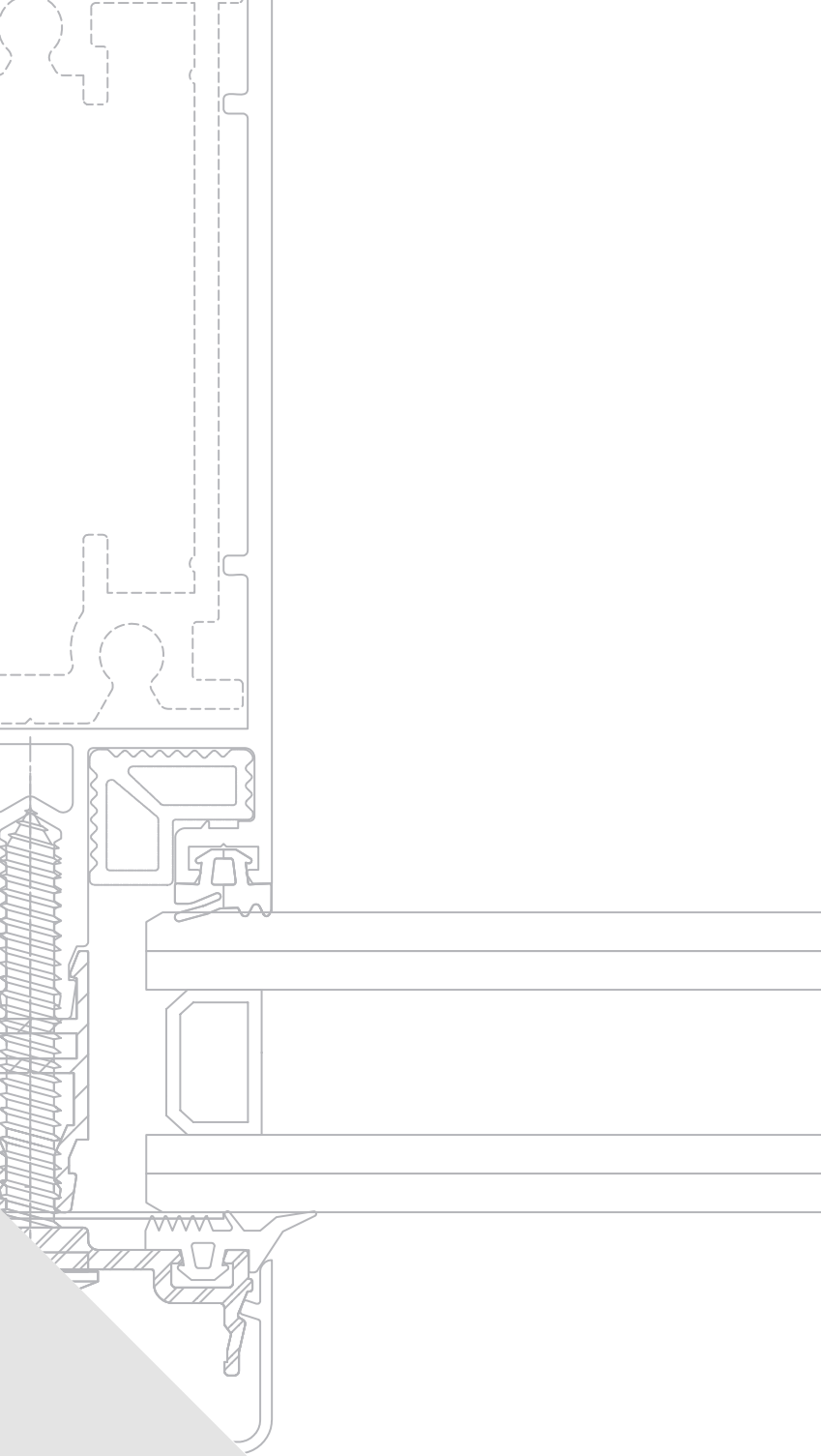



EW500

FACCIATA CONTINUA
CURTAIN WALL



TWIN
SYSTEMS

ARCHITETTURE IN ALLUMINIO



TWIN SYSTEMS

ARCHITETTURE IN ALLUMINIO

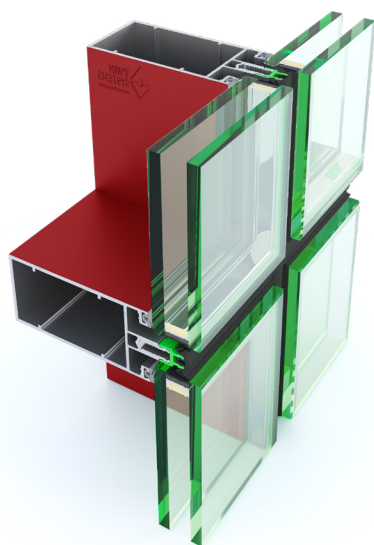

Evolution GLASS

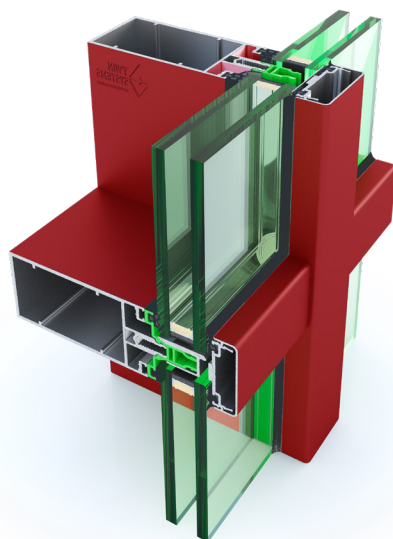

Evolution

Gruppo A Informazioni Generali *Informazioni Generali*

Indice Generale
Caratteristiche Alluminio
Descrizione Tecnica sistema
Descrizione Tecnica Capitolato
Collaudi Prestazionali

*Table of Contents
Aluminium Characteristics
Technical Description
Technical Specifications
Performance Tests*

Gruppo B Profili *Profiles*

Elenco Profili
Profili Scala 1:1

*Profiles List
Profiles Scale 1:1*

Gruppo C Accessori e Guarnizioni *Accessories and Gaskets*

Elenco accessori
Elenco guarnizioni

*List of Accessories
List of Window Gaskets*

Gruppo D Nodi *Main Sections*

Sezioni principali
e Accessori
Sc. 1:1

*Main Sections and
Accessories
Scale 1:1*

Gruppo E Tipologie *Types*

Tipologie

Types

Gruppo F Attacco alla Muratura *Wall Joint*

Sezione particolareggiata
attacco alla muratura

Wall Joint Detail

Gruppo G Lavorazioni/Montaggi *Tooling/Assembly*

Schemi Lavorazioni
Frese
Attrezzatura

*Tooling Systems
Cutters Equipments
Milling*

Tutti i dati riportati sul presente catalogo sono indicativi e non impegnativi. La società si riserva il diritto di apportare in qualsiasi momento modifiche atte a migliorare i prodotti. Per informazioni tecniche riguardanti il catalogo contattare l'ufficio tecnico.

All the data shown in this catalog are indicative and not binding. The company reserves the right to make changes to improve the products at any time. For technical information regarding the catalog, contact the technical department.

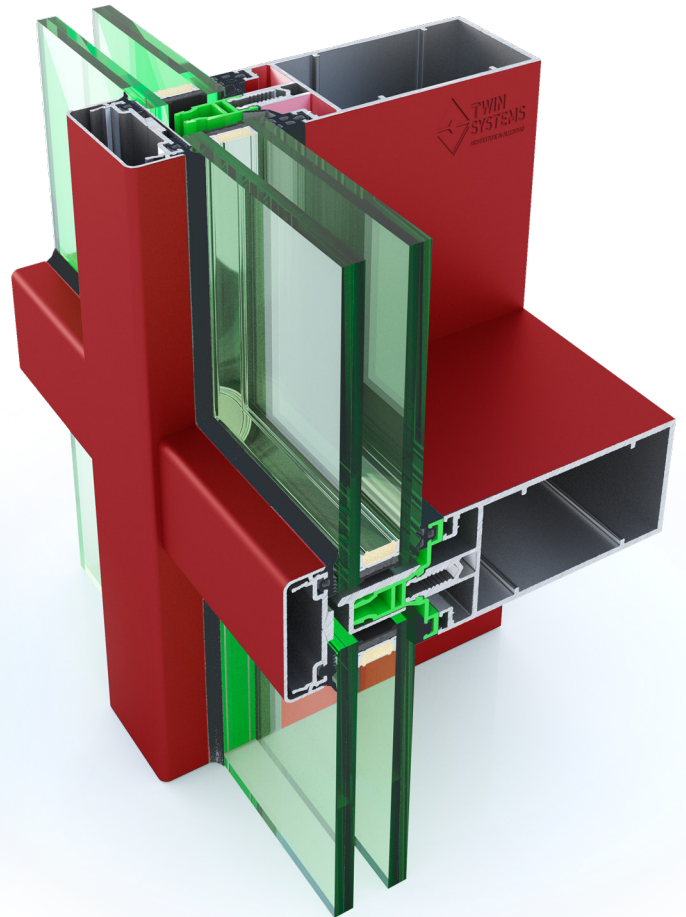
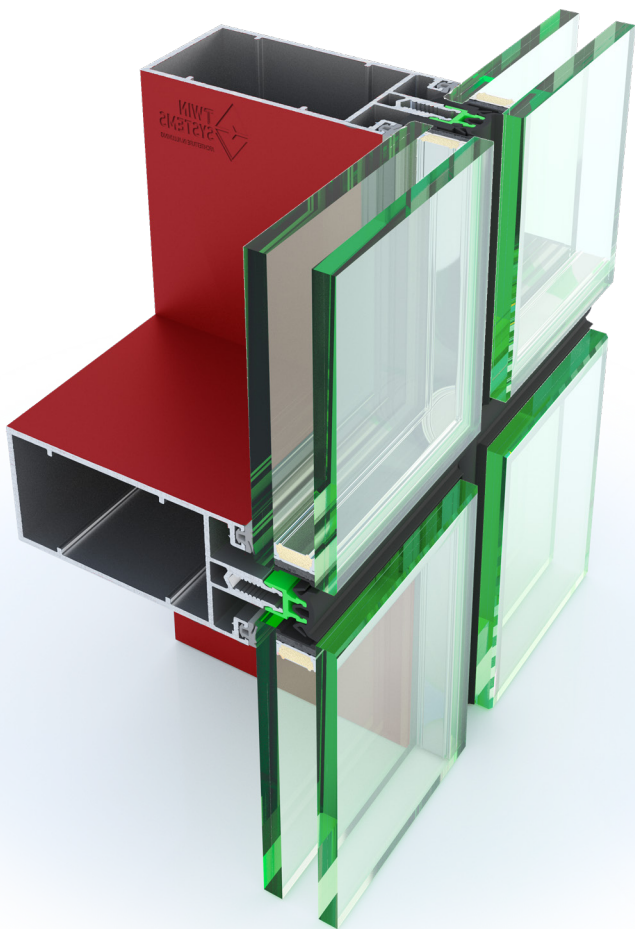

Evolution **GLASS**

Informazioni Generali
General Information

Gruppo A

Evolution

Indice Generale	<i>Table of Contents</i>
Caratteristiche Alluminio	<i>Aluminium Characteristics</i>
Descrizione Tecnica sistema	<i>Technical Description</i>
Descrizione Tecnica Capitolato	<i>Technical Specifications</i>
Collaudi Prestazionali	<i>Performance Tests</i>

**PESO PROFILATI**

Il peso indicato è quello teorico e potrà variare in funzione delle tolleranze di spessore e dimensionali dei profilati (NORMA UNI EN 12020-2)

LEGA DI ESTRUSIONE

I profilati sono estrusi in lega EN-AW-6060 (UNI EN 573/3) sottoposti ad un processo di trattamento termico applicato secondo la Normativa UNI EN 755-2 (bonifica con tempra in aria alla pressa, seguita da invecchiamento artificiale) per ottenere lo stato fisico T5.

DIMENSIONI DEI PROFILATI

Le dimensioni indicate sono quelle teoriche, potranno quindi variare in funzione delle tolleranze dimensionali di estrusione (norma UNI EN 12020-2). Questa variabilità che interessa tutti i profilati, può influire, anche se minimamente, sulle dimensioni di taglio e quindi finali del serramento. Anche la verniciatura, aumentando gli spessori, contribuisce a far variare la dimensione dei profilati e, particolarmente, riduce lo spazio nelle sedi di inserimento delle guarnizioni e degli accessori.

DIMENSIONI DI TAGLIO E LAVORAZIONI

Le dimensioni teoriche di taglio e le quote delle lavorazioni indicate nel presente catalogo sono esatte, ovvero matematicamente corrette, in certi casi dovranno, nella pratica, essere adattate in base alla precisione ed al tipo di impostazione delle misure delle macchine utilizzate. È pertanto consigliabile nei primi lavori o nel caso di importanti quantità di serramenti effettuare delle campionature di prova.

L'evacuazione dell'eventuale acqua o condensa dal serramento sarà garantita da scarichi praticati sulle traverse inferiori del medesimo garantendone il libero deflusso dagli appositi scarichi dalle traverse e dai montanti di facciata.

PROTEZIONE SUPERFICIALE

Al fine di limitare i processi di corrosione filiforme è importante applicare le seguenti regole:

- ◆ Utilizzare accessori di assemblaggio in alluminio
- ◆ Utilizzare viti in acciaio inox
- ◆ Proteggere le parti tagliate e lavorate con prodotti idonei
- ◆ Evitare ristagni di condense all'interno dei profilati.

Per la realizzazione della facciata è necessario attenersi alla tecnologia costruttiva e utilizzare le guarnizioni e gli accessori originali riportati sul catalogo tecnico e al rispetto delle norme, prescrizioni e raccomandazioni vigenti.

L'osservanza di quanto sopra determina la garanzia.

Su queste basi sono stati realizzati campioni che, collaudati in laboratorio hanno ottenuto i risultati indicati nelle certificazioni. Per il buon funzionamento e la durata delle facciate realizzate con profilati ed accessori del sistema, è necessario effettuare alcune semplici operazioni:

- ◆ Una buona pulizia, eliminando residui di calce, cemento e/o altro.
- ◆ Proteggere il manufatto sino al momento della messa in esercizio, lubrificare con olio o grasso neutri le parti in movimento e gli organi di chiusura, controllare il corretto serraggio delle viti e dei grani, controllare gli assetti, registrandoli laddove sono previste regolazioni.
- ◆ Effettuare queste operazioni almeno con cadenza semestrale.

WEIGHT OF PROFILES

The weight indicated is the theoretical one and may vary depending on the thickness and dimensional tolerances of the profiles (STANDARD UNI EN 12020-2)

EXTRUSION ALLOY

The profiles are extruded in EN-AW-6060 alloy (UNI EN 573/3) subjected to a heat treatment process applied according to the UNI EN 755-2 Regulation (hardening with hardening in air at the press, followed by artificial ageing) to obtain the physical state T5.

DIMENSIONS OF PROFILES

The dimensions indicated are the theoretical ones; they may vary depending on the dimensional extrusion tolerances (UNI EN 12020-2 standard). This variability, which affects all profiles, can influence, even if minimally, the cutting and therefore final dimensions of the window. Painting, by increasing the thicknesses, also contributes to varying the size of the profiles and, in particular, reduces the space in the places where the gaskets and accessories are inserted.

CUTTING AND TOOLING DIMENSIONS

The theoretical cutting dimensions and processing dimensions indicated in this catalog are exact, i.e. mathematically correct, in certain cases they must, in practice, be adapted based on the precision and type of measurement setting of the machines used. It is therefore advisable to carry out test sampling during the first jobs or in the case of large quantities of windows and doors.

The evacuation of any water or condensation from the window will be guaranteed by drains made on the lower crosspieces of the same, ensuring free flow from the appropriate drains from the crosspieces and facade uprights.

SURFACE PROTECTION

In order to limit filiform corrosion processes it is important to apply the following rules:

- ◆ Use aluminum assembly accessories
- ◆ Use stainless steel screws
- ◆ Protect the cut and machined parts with suitable products
- ◆ Avoid stagnation of condensation inside the profiles.

To create the facade it is necessary to follow the construction technology and use the gaskets and seals original accessories listed in the technical catalog and in compliance with the standards, prescriptions and recommendations in force.

Compliance with the above determines the warranty.

On this basis, samples were created which, when tested in the laboratory, obtained the results indicated in the certifications. For the good functioning and durability of the facades made with profiles and accessories of the system, it is necessary to carry out some simple operations:

- ◆ A good cleaning, eliminating lime, cement and/or other residues.
- ◆ Protect the product until it is put into operation, lubricate the moving parts and closing devices with neutral oil or grease, check the correct tightening of the screws and grub screws, check the settings, adjusting them where adjustments are required.
- ◆ Carry out these operations at least every six months.
- ◆ In the event of abnormal functioning of any component, absolutely avoid interventions aimed at modifying its characteristics and replacement with non-original spare parts.
- ◆ Adjustment and/or replacement interventions must be carried out by specialized personnel.



- ◆ In caso di funzionamento anomalo di qualche componente, evitare assolutamente interventi atti a modificarne le caratteristiche e la sostituzione con ricambi non originali.
- ◆ Interventi di regolazione e/o sostituzione andranno eseguiti da personale specializzato.
- ◆ In occasione delle operazioni di pulizia, di non utilizzare detergenti che possano deteriorare i trattamenti superficiali, escludendo tassativamente acidi, solventi, materiali abrasivi, spazzole metalliche o comunque in grado di scalfire le superfici, pagliette metalliche e altro.

TIPOLOGIA E DIMENSIONI DELLA FACCIATA CONTINUA METALLICA.

La facciata continua in alluminio a taglio termico sarà dei tipi

- **EW500 Evolution:** tipologia "montanti e traversi" con sezione in vista, sia interna che esterna, di mm. 50 e con profondità da 50 a 300 mm.
 - **EW500 Evolution GLASS:** a "Effetto Strutturale" con sezione in vista, sia interna che esterna, di mm. 50 e con profondità da 50 a 300 mm.
- Entrambe saranno realizzate con profilati estrusi in lega d'alluminio primario da lavorazione plastica rispondenti alla normativa EN AW 6060 UNI-EN 573-3 sottoposti ad un processo di trattamento termico applicato secondo la Normativa UNI EN 755-2 (bonifica con tempra in aria alla pressa, seguita da invecchiamento artificiale) per ottenere lo stato fisico T5; con spessore nominale nella parte tubolare strutturale, non inferiore a 2.5 mm, adatti all'ossidazione anodica ed alla verniciatura superficiale.

•EW500 EVOLUTION GLASS:

La facciata non dovrà essere una facciata strutturale, ma esternamente non ci dovrà essere alluminio in vista. I telai in alluminio dovranno quindi trattenere meccanicamente il vetro interno senza dover essere a contatto con sigillante siliconico strutturale. Saranno solo i due vetri, interno ed esterno, ad essere siliconati strutturalmente tra di loro. Il vetro esterno dovrà essere sorretto da due supporti in acciaio oppure in alluminio.

Il fissaggio delle traverse ai montanti avverrà tramite cavallotti in acciaio inox con apposito ritegno. Questo sistema, privo di bloccaggi fissi come le viti, con l'aggiunta di un "tappo stampato" di contorno, posto nella sede d'alloggiamento tra il montante e la traversa, consentirà una corretta dilatazione termica esente da fastidiosi scricchiolii e garantirà con precisione la modularità orizzontale teorica poiché il taglio dei traversi privi di lavorazioni non potrà in alcun modo interferire con il posizionamento dei montanti. Con facciate non rettilinee aventi inclinazioni in pianta variabili, sarà necessario l'uso d'accessori d'adattamento e viti di bloccaggio che garantiscano, tramite asolatura, la dilatazione. Esternamente gli scuretti tra un vetro e l'altro, sia in verticale sia in orizzontale, saranno di circa 20 mm e non ci sarà diversità visiva tra le parti apribili e quelle fisse.

I profilati dei telai su cui sarà inserito il vetro dovranno garantire che esteticamente non ci sarà nessuna differenza di colore tra la parte in vista interna ed esterna, specialmente con serramento apribile in fase d'apertura, in modo tale che cromaticamente si possa osservare solamente un colore dall'interno, quello dei profilati d'alluminio, ed uno dall'esterno, quello dei vetri. Il produttore del silicone strutturale, tramite vetrai qualificati da lui indicati, darà le indicazioni necessarie per la realizzazione dei telai in alluminio siliconati strutturalmente al vetro.

- ◆ *During cleaning operations, do not use detergents that could deteriorate the surface treatments, strictly excluding acids, solvents, abrasive materials, metal brushes or those capable of scratching the surfaces, metal wool and other things.*

TYPE AND DIMENSIONS OF THE METAL CURTAIN WALL.

Thermal break aluminum curtain wall will be of the types:

- ◆ **EW500 Evolution:** "Uprights and Transoms" type with exposed section, both internal and external, of mm. 50 and with depths from 50 to 300 mm.
- ◆ **EW500 Evolution GLASS:** with "Structural Effect" with visible section, both internal and external, of mm. 50 and with depths from 50 to 300 mm.

Both will be made with extruded profiles in primary aluminum alloy for plastic processing complying with the EN AW 6060 UNI-EN 573-3 regulation subjected to a heat treatment process applied according to the UNI EN 755-2 regulation (hardening with quenching in air at press, followed by artificial ageing) to obtain the T5 physical state; with nominal thickness in the structural tubular part, not less than 2.5 mm, suitable for anodic oxidation and surface painting.

EW500 EVOLUTION GLASS:

The facade must not be a structural facade, but there must be no visible aluminum externally. The aluminum frames will therefore have to mechanically hold the internal glass without having to be in contact with structural silicone sealant. Only the two glasses, internal and external, will be structurally siliconed together. The external glass must be supported by two steel or aluminum supports.

The fixing of the crosspieces to the uprights will take place using stainless steel U-bolts with specific retainers. This system, free of fixed locks such as screws, with the addition of a contour "molded cap", placed in the housing seat between the upright and the crosspiece, will allow correct thermal expansion free from annoying creaking and will guarantee precise the theoretical horizontal modularity since the cutting of the transoms without machining cannot in any way interfere with the positioning of the uprights. With non-rectilinear facades having variable inclinations in plan, it will be necessary to use adaptation accessories and locking screws which ensure expansion by means of slots. Externally, the shutters between one glass and the other, both vertically and horizontally, will be approximately 20 mm and there will be no visual difference between the opening and fixed parts.

The profiles of the frames on which the glass will be inserted must guarantee that aesthetically there will be no difference in color between the internal and external visible part, especially with the window opening during the opening phase, so that chromatically only one can observe color from the inside, that of the aluminum profiles, and one from the outside, that of the glass. The manufacturer of the structural silicone, through qualified glassmakers indicated by him, will give the necessary instructions for the creation of aluminum frames structurally siliconed to the glass.



STRUTTURA DELLA FACCIATA CONTINUA

La dimensione in profondità dei profilati sarà scelta in funzione ai calcoli statici, secondo le normative vigenti, ed alle dimensioni modulari della facciata. Il fissaggio delle traverse ai montanti avverrà tramite perni in acciaio. Questo sistema privo di bloccaggi fissi come le viti, con l'aggiunta di un "angolo stampato" di contorno posto nella sede d'alloggiamento tra il montante e la traversa, consentirà una corretta dilatazione termica esente da fastidiosi scricchiolii e garantirà con precisione la modularità orizzontale teorica poiché il taglio dei traversi, privi di lavorazioni, non potrà in alcun modo interferire con il posizionamento dei montanti. Solo con facciate non rettilinee, aventi inclinazioni in pianta variabili, sarà necessario l'uso d'accessori d'adattamento e viti di bloccaggio che garantiranno, tramite asolatura, la dilatazione termica.

ANCORAGGIO ALLA STRUTTURA PORTANTE

I montanti saranno fissati alla struttura portante dell'edificio mediante staffe in alluminio che ne consentiranno il movimento nelle tre direzioni cartesiane con tolleranza da +20 mm a -20 mm sulle strutture dell'edificio. Appositi canotti, in alluminio, collaboreranno all'ancoraggio dei montanti alla struttura portante consentendo il perfetto allineamento tra di loro e permettendo la continuità statica nei giunti di dilatazione.

TAGLIO TERMICO E BLOCCAGGIO DEI TAMPONAMENTI DI FACCIATA

Barrette in materiale isolante, incastrabili a scatto tra di loro, da un minimo di 6 mm. sino ad un massimo di 38 mm ed oltre, consentiranno di poter realizzare un taglio termico tra gli elementi interni e quelli esterni della struttura di facciata, permettendo di poter inserire tamponamenti con escursioni che andranno da un minimo di 10 mm. sino ad un massimo di 43 mm. ed oltre.

Il bloccaggio dei tamponamenti avverrà tramite un pressore asolato in alluminio che serrerà, tramite viti autofilettanti in acciaio inox di diverse lunghezze, gli stessi ai profilati di struttura. Guarnizioni in EPDM, di diverse dimensioni, si interporranno, sia all'interno che all'esterno, tra i profilati in alluminio ed i tamponamenti. Copertine a scatto, di diversa foggia e profondità tra montanti e traverse, maschereranno alla vista le viti di fissaggio. Eventuali infiltrazioni d'acqua o creazione di condensa verranno evacuate all'esterno direttamente da asole praticate sui pressori e copertine orizzontali oppure attraverso i montanti. Appositi tappi in elastomero sigilleranno le giunzioni tra montante/montante e montante/traversi.

TAMPONAMENTI DI FACCIATA [VETRAZIONI]

La facciata continua sarà dotata di vetrazioni, inserite all'interno del reticolo di facciata, aventi le seguenti caratteristiche:

- 8 temperato-camera 16 mm-6/7 interno.
- 1.6 Tamponamenti di facciata - Parti apribili

La facciata continua sarà dotata, se richieste di parti apribili, inseriti all'interno del reticolo di facciata, con i seguenti tipi di apertura:

- ◆ a sporgere
- ◆ a battente con profilati in vista (anta o anta-ribalta)
- ◆ a battente con anta a scomparsa (anta o anta-ribalta)

STRUCTURE OF THE CURTAIN WALL

The depth dimension of the profiles will be chosen based on the static calculations, according to current regulations, and the modular dimensions of the facade. The fixing of the crosspieces to the uprights will take place using steel pins. This system without fixed locks such as screws, with the addition of a contour "printed corner" placed in the housing seat between the upright and the crosspiece, will allow correct thermal expansion free from annoying creaks and will precisely guarantee modularity theoretical horizontal since the cutting of the crosspieces, without any machining, will in no way interfere with the positioning of the uprights. Only with non-rectilinear facades, with variable inclinations in plan, will it be necessary to use adaptation accessories and locking screws which will guarantee, through slots, thermal expansion.

ANCHORING TO THE BEARING STRUCTURE

The uprights will be fixed to the load-bearing structure of the building using aluminum brackets which will allow them to move in the three Cartesian directions with a tolerance of +20 mm to -20 mm on the building structures. Special aluminum tubes will collaborate in anchoring the uprights to the load-bearing structure, allowing perfect alignment between them and allowing static continuity in the expansion joints.

THERMAL BREAK AND BLOCKAGE OF FAÇADE INSERTS

Bars in insulating material, snap-fit together, from a minimum of 6 mm. up to a maximum of 38 mm and beyond, will allow a thermal break to be created between the internal and external elements of the facade structure, allowing it to be possible to insert infills with excursions ranging from a minimum of 10 mm. up to a maximum of 43 mm. and beyond.

The blocking of the infills will take place via a slotted aluminum presser which will tighten them to the structural profiles using self-tapping stainless steel screws of different lengths. EPDM gaskets, of different sizes, will be placed, both internally and externally, between the aluminum profiles and the infills. Snap covers, of different shape and depth between uprights and crosspieces, will hide the fixing screws from view. Any water infiltration or creation of condensation will be evacuated outside directly through slots made on the pressure plates and horizontal covers or through the uprights. Special elastomer caps will seal the joints between the upright/upright and upright/transoms.

FACADE INSULATIONS [GLAZING]

The curtain wall will be equipped with glazing, inserted within the facade grid, having the following characteristics:

- 8 tempered + hamber 16 mm + 6/7 internal.
- 1.6 Facade infills - Openable parts

The curtain wall will be equipped, if requested, with opening parts, inserted inside the facade grid, with the following types of opening:

- ◆ to stick out.
- ◆ swing with visible profiles (door or tilt-and-turn).
- ◆ swing with retractable door (door or tilt-and-turn).

**ACCESSORI**

Gli accessori saranno originali del sistema EW500 sia per le parti fisse che per quelle apribili.

GUARNIZIONI

Le guarnizioni saranno originali del sistema EW500, sia per le parti fisse che per quelle apribili.

Le guarnizioni di tenuta dovranno essere tagliate alla quota esterna del profilo con una maggiorazione dello 0.8% per quelle a sezione ridotta e dello 0.5% per quelle a sezione grande.

Per unire le guarnizioni tra loro si dovrà usare collante cianoacrilico tipo Loctite 414 (incollaggio normale) o Loctite 424 (incollaggio rapido) proteggendo le parti incollate con mastice butilico tipo Vaber IB 230 nero. si dovrà usare sigillante siliconico per parti in metallo o fra metallo e Beton, semprechè il giunto non abbia una escursione massima (dilatazione-contrazione) oltre il 100% dello spessore della sigillatura (il silicone si allunga e in parte si comprime, al massimo, il 100% del suo spessore). Pulire accuratamente le superfici prima di sigillare. La polvere, l'unto, l'umidità o temperature molto basse (-15°C per il silicone) determinano una precaria adesione con conseguente perdita di tenuta e gravi pregiudizi nel tempo

SIGILLANTI DI TENUTA ALL'ACQUA ED ALL'ARIA

I sigillanti utilizzati dovranno garantire alla facciata le prestazioni di permeabilità all'aria, tenuta all'acqua, tenuta alla polvere, isolamento termoacustico ed essere compatibili con i materiali con cui verranno in contatto e conformi alle norme di riferimento per lo specifico materiale utilizzato.

FINITURE SUPERFICIALI DEI TELAI METALLICI

La finitura superficiale dei telai della facciata continua, a seconda del ipo da utilizzare sarà realizzata a seconda del materiale scelto e delle norme di riferimento), avrà le proprietà previste dalle norme di riferimento per il tipo di finitura scelta), spessore in funzione dell'applicazione a cui le facciate continue di progetto sono destinate e colore come da decisione progettuale secondo le paalette RAL disponibili al produttore. La finitura avrà caratteristiche visive superficiali (uniformità d'aspetto, tonalità della colorazione, ecc.) approvate dal Committente e/o dalla Direzione Lavori a mezzo di due campioni corrispondenti ai limiti di tolleranza delle caratteristiche stesse. Minimi scostamenti nel lotto di fornitura saranno considerati accettabili. I manufatti dovranno essere esenti da difetti (graffi, rigonfiamenti, colature, ondulazioni ed altre imperfezioni) visibili ad occhio nudo alla distanza non inferiore a 5 metri per applicazioni esterne e 3 metri per applicazioni interne. Saranno preferiti prodotti con finiture superficiali a marchio di qualità (il marchio Qualanod per l'ossidazione anodica dell'alluminio, il marchio Qualicoat per la verniciatura, il marchio RAL). Le finiture superficiali dei telai metallici non dovranno subire corrosioni o alterazioni di aspetto per un periodo di tempo adeguato alla vita del manufatto. Pertanto dovranno essere adottati tutti gli accorgimenti atti ad evitare il contatto degli elementi metallici con sostanze o materiali che possano instaurare fenomeni corrosivi

ACCESSORIES

The accessories will be original to the EW500 system for both the fixed and openable parts.

GASKETS

The gaskets will be original to the EW500 system, both for the fixed and openable parts.

The sealing gaskets must be cut at the external level of the profile with an increase of 0.8% for those with a small section and 0.5% for those with a large section.

To join the gaskets together, cyanoacrylic glue such as Loctite 414 (normal gluing) or Loctite 424 (quick gluing) must be used, protecting the glued parts with black butyl mastic such as Vaber IB 230. silicone sealant must be used for metal parts or between metal and concrete, as long as the joint does not have a maximum excursion (dilation-contraction) beyond 100% of the thickness of the seal (the silicone stretches and partially compresses, at most, 100% of its thickness). Carefully clean the surfaces before sealing. Dust, grease, humidity or very low temperatures (-15°C for silicone) cause precarious adhesion with consequent loss of seal and serious prejudices over time

WATER AND AIR SEALANTS

The sealants used must guarantee the facade the performance of air permeability, water tightness, dust tightness, thermo-acoustic insulation and be compatible with the materials with which they will come into contact and comply with the reference standards for the specific material used.

SURFACE FINISHES OF METAL FRAMES

The surface finish of the curtain wall frames, depending on the type to be used, will be made according to the material chosen and the reference standards), will have the properties foreseen by the reference standards for the type of finish chosen), thickness depending on the application for which the project curtain walls are intended and color as per the design decision according to the RAL palettes available to the manufacturer. The finish will have superficial visual characteristics (uniformity of appearance, color tone, etc.) approved by the Client and/or the Works Management by means of two samples corresponding to the tolerance limits of the characteristics themselves. Minimal deviations in the supply batch will be considered acceptable. The products must be free from defects (scratches, bulges, drips, waviness and other imperfections) visible to the naked eye at a distance of no less than 5 meters for external applications and 3 meters for internal applications. Products with quality brand surface finishes will be preferred (the Qualanod brand for the anodic oxidation of aluminium, the Qualicoat brand for painting, the RAL brand). The surface finishes of the metal frames must not undergo corrosion or alterations in appearance for a period of time adequate for the life of the product. Therefore, all measures must be taken to avoid contact of the metal elements with substances or materials that could cause corrosive phenomena.



PRESTAZIONI CERTIFICATE

PERMEABILITÀ ALL'ARIA

La facciata sarà almeno di classe di permeabilità all'aria E750, secondo norma EN 12152 (Facciate continue / Permeabilità all'aria / Requisiti e prestazioni)

La prestazione dovrà essere attestata mediante una prova di laboratorio condotta secondo la metodologia di prova della norma UNI EN 12153 (Facciate continue / Permeabilità all'aria / Metodo di prova)

Qualora la facciata continua comprenda anche parti apribili, queste saranno di classe di permeabilità all'aria 4 secondo norma UNI EN 12207 (Finestre e porte finestre / Permeabilità all'aria / classificazione), attestata mediante prove di laboratorio secondo la metodologia di prova della norma UNI EN 1026 (Porte e finestre / Permeabilità all'aria / Metodo di prova).

TENUTA ALL'ACQUA

La facciata sarà almeno di classe di tenuta all'acqua RE750 secondo norma UNI EN 12154 (Facciate continue / Tenuta all'acqua / Requisiti prestazionali e classificazione).

La prestazione dovrà essere attestata mediante una prova di laboratorio condotta secondo la metodologia di prova della norma UNI EN 12155 (Facciate continue / Tenuta all'acqua / Prova di laboratorio sotto pressione statica).

RESISTENZA AL VENTO

La facciata continua, sottoposta a prova in laboratorio secondo il metodo previsto dalla norma EN 12179 (Facciate continue / Resistenza al vento / Metodo di prova), dovrà essere in grado di resistere in modo adeguato alla spinta del vento di progetto (carico di servizio), applicata sia in pressione che in depressione, e dovrà essere in grado di trasferire completamente tale azione alla struttura portante dell'edificio per mezzo di idonei vincoli di ancoraggio.

Il carico di vento di progetto dovrà essere determinato in base alla normativa nazionale vigente e sotto tale azione la deformazione elastica massima (misurata perpendicolarmente al piano della facciata) degli elementi di telaio, non dovrà essere superiore a 1/200 della distanza misurata tra due successivi punti di vincolo alla struttura dell'edificio e comunque non superare il limite di 15 mm., in accordo con quanto indicato dalla norma EN 13116 (Facciate continue / Resistenza al vento / Requisiti e prestazioni).

Inoltre la facciata continua dovrà essere in grado di resistere in modo adeguato alla spinta del vento di progetto incrementata di 1.5 volte (carico di sicurezza), applicata sia in pressione che in depressione, e sotto tale azione non dovranno verificarsi deformazioni e danneggiamenti permanenti negli elementi di telaio, parti apribili, elementi di tamponamento, ancoraggi ed elementi di fissaggio e non dovranno verificarsi rotture dei vetri, distacchi di guarnizioni, fermavetri e cornici e profili decorativi, il tutto in accordo con quanto indicato dalla norma EN 13116.

L'adeguata rigidità della facciata sarà determinata per calcolo teorico ed in tale processo non si potrà tenere conto, in alcun modo, del potenziale contributo di rigidità dovuto alla presenza delle vetrazioni.

ISOLAMENTO TERMICO

La facciata continua dovrà avere trasmittanza termica media complessiva U, non superiore a 2.2 W/m²K calcolata secondo il procedimento indicato dal progetto di norma EN 13947 (Curtain walling / Calculation of thermal transmittance / Simplified method).

CERTIFIED TESTS

AIR PERMEABILITY

The façade will have at least air permeability class E750, according to EN 12152 (Curtain walls / Air permeability / Requirements and performance)

The performance must be certified through a laboratory test conducted according to the test methodology of the UNI EN 12153 standard (Curtain walls / Air permeability / Test method)

If the curtain wall also includes openable parts, these will be of air permeability class 4 according to the UNI EN 12207 standard (Windows and French windows / Air permeability / classification), certified through laboratory tests according to the test methodology of the standard UNI EN 1026 (Doors and windows / Air permeability / Test method).

WATER TIGHT

The façade will have at least RE750 water tightness class according to UNI EN 12154 (Curtain walls / Water tightness / Performance requirements and classification).

The performance must be certified through a laboratory test conducted according to the test methodology of the UNI EN 12155 standard (Curtain walls / Water tightness / Laboratory test under static pressure).

WIND RESISTANCE

The curtain wall, subjected to laboratory testing according to the method required by the EN 12179 standard (Curtain walls / Wind resistance / Test method), must be able to adequately resist the design wind thrust (service load), applied both under pressure and under depression, and must be able to completely transfer this action to the load-bearing structure of the building by means of suitable anchoring constraints.

The design wind load must be determined based on the national legislation in force and under this action the maximum elastic deformation (measured perpendicular to the plane of the facade) of the frame elements must not be greater than 1/200 of the distance measured between two successive constraint points to the building structure and in any case do not exceed the limit of 15 mm, in accordance with what is indicated by the EN 13116 standard (Curtain walls / Wind resistance / Requirements and performances).

Furthermore, the curtain wall must be able to adequately resist the design wind thrust increased by 1.5 times (safety load), applied both in pressure and in depression, and under this action there must be no permanent deformations and damages in the elements of the frame, opening parts, infill elements, anchors and fixing elements and there must be no breakage of the glass, detachment of gaskets, glazing beads and frames and decorative profiles, all in accordance with what is indicated in the EN 13116 standard.

The adequate stiffness of the facade will be determined by theoretical calculation and in this process it will not be possible to take into account, in any way, the potential contribution of stiffness due to the presence of glazing.

THERMAL INSULATION

The curtain wall must have an overall average thermal transmittance U, not exceeding 2.2 W/m²K calculated according to the procedure indicated by the draft standard EN 13947 (Curtain walling / Calculation of thermal transmittance / Simplified method).



CONTROLLO DELLA PERMEABILITÀ AL VAPORE ACQUEO

La facciata, ed ogni singola sua parte fissa ed apribile, dovrà essere progettata e realizzata in modo tale da garantire il controllo della permeabilità al vapore acqueo, al fine di evitare la possibile formazione di condensa interstiziale e superficiale. Le eventuali condensazioni dovranno essere controllate per mezzo di idonee barriere al vapore e se necessario evacuate all'esterno. Eventualmente potrà essere richiesta una verifica termoigrometrica che dimostri l'impossibilità di formazione di condensa interstiziale e superficiale in ogni parte della facciata, eseguita secondo il metodo approssimato di Glaser o con qualsiasi altro metodo di calcolo riconosciuto, impiegando le condizioni termoigrometriche interne ed esterne di progetto.

RESISTENZA AI CARICHI PERMANENTI ED ACCIDENTALI

La facciata dovrà essere progettata e realizzata per sostenere il peso proprio oltre a qualsiasi altro carico verticale accidentale previsto in sede di progetto. Tali carichi dovranno essere trasferiti completamente alla struttura portante dell'edificio per mezzo dei vincoli di ancoraggio della facciata. La deformazione elastica massima (misurata nel piano della facciata) degli elementi di telaio orizzontali sotto l'azione di carichi verticali non dovrà superare 1/500 della luce libera d'inflessione e comunque essere inferiore a 3 mm. La facciata continua dovrà essere progettata e costruita per sostenere in modo idoneo un carico accidentale orizzontale applicato ad un'altezza di 1.20 m. dal piano di calpestio e pari a KN/m (indicare in specifico il valore in accordo con quanto indicato al prospetto 5.1 della Circolare 4 luglio 1996 n° 156AA.GG.STC Istruzioni per l'applicazione delle norme tecniche relative ai "criteri generali per la verifica di sicurezza delle costruzioni e dei carichi e sovraccarichi" di cui al decreto ministeriale del 16 gennaio 1996). Qualora in sede di progetto sia previsto il completamento della facciata con componenti accessori quali frangisole, insegne, passerelle e/o ponteggi sospesi motorizzati (navicelle) per la pulizia e manutenzione, i relativi carichi permanenti ed accidentali, sia verticali che orizzontali, dovranno essere idoneamente sostenuti dagli elementi di telaio e di fissaggio della facciata ed essere trasferiti completamente alla struttura portante dell'edificio.

ISOLAMENTO ACUSTICO

La facciata continua, valutata in corrispondenza della sua sezione caratteristica, dovrà avere un indice di valutazione del potere fonoisolante R_w di dB determinato sperimentalmente in laboratorio secondo la UNI EN ISO 140/3 e valutato in accordo con la norma UNI EN ISO 717/1. In alternativa il potere fonoisolante potrà essere stimato sulla base di un calcolo teorico riconosciuto. Ai fini della valutazione dell'indice di valutazione dell'isolamento acustico di facciata normalizzato rispetto al tempo di riverberazione ($D2m,nT, W$), questo potrà essere determinato attraverso il calcolo basato sul metodo stabilito dalla norma EN 12354/3 Acustica negli edifici - Valutazione delle prestazioni acustiche degli edifici a partire dalle prestazioni dei prodotti - Isolamento acustico contro il rumore proveniente dall'esterno per via aerea.

RESISTENZA ALL'URTO

La facciata dovrà avere una classe di resistenza all'urto interna I5 ed esterna E5 certificata mediante le prove di laboratorio previste dal progetto di norma prEN 13049.

CONTROL OF WATER VAPOR PERMEABILITY

The façade, and each of its fixed and openable parts, must be designed and built in such a way as to guarantee control of water vapor permeability, in order to avoid the possible formation of interstitial and surface condensation. Any condensation must be controlled by means of suitable vapor barriers and if necessary evacuated outside. Possibly, a thermo-hygrometric check may be requested to demonstrate the impossibility of the formation of interstitial and surface condensation in every part of the facade, carried out according to the approximate Glaser method or with any other recognized calculation method, using the internal and external thermo-hygrometric conditions of the project.

RESISTANCE TO PERMANENT AND ACCIDENTAL LOADS

The facade must be designed and built to support its own weight in addition to any other accidental vertical load foreseen in the design. These loads must be transferred completely to the load-bearing structure of the building by means of the anchoring constraints of the facade. The maximum elastic deformation (measured in the plane of the facade) of the horizontal frame elements under the action of vertical loads must not exceed 1/500 of the free deflection span and in any case be less than 3 mm. The curtain wall must be designed and built to adequately support a horizontal live load applied at a height of 1.20 m. from the walking surface and equal to KN/m (specifically indicate the value in accordance with what is indicated in table 5.1 of Circular 4 July 1996 n° 156AA.GG.STC Instructions for the application of the technical standards relating to the "general criteria for the safety verification of constructions and loads and overloads" referred to in the ministerial decree of 16 January 1996). If the project includes completion of the façade with accessory components such as sunshades, signs, walkways and/or motorized suspended scaffolding (nacelles) for cleaning and maintenance, the related permanent and accidental loads, both vertical and horizontal, must be suitably supported by the frame and fastening elements of the facade and be transferred completely to the load-bearing structure of the building.

SOUNDPROOFING

The curtain wall, evaluated in correspondence with its characteristic section, must have an evaluation index of the sound insulation power R_w of dB determined experimentally in the laboratory according to UNI EN ISO 140/3 and evaluated in accordance with UNI EN ISO 717/1. Alternatively, the sound insulation power can be estimated on the basis of a recognized theoretical calculation. For the purposes of evaluating the facade acoustic insulation evaluation index normalized with respect to the reverberation time ($D2m,nT, W$), this can be determined through the calculation based on the method established by the EN 12354/3 standard Acoustics in buildings - Evaluation of the acoustic performance of buildings starting from the performance of the products - Acoustic insulation against noise coming from outside by air.

IMPACT RESISTANCE

The facade must have an internal I5 and external E5 impact resistance class certified through the laboratory tests required by the prEN 13049 draft standard.

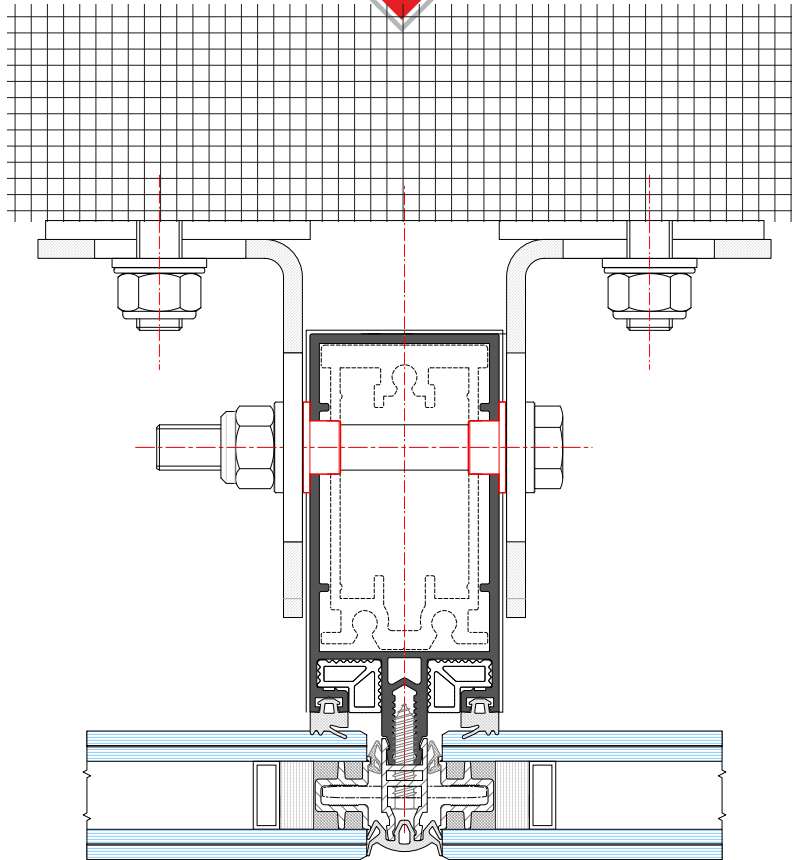

Agenti Atmosferici | Atmospherics

Tenuta all'Acqua
Watertightness



Capacità di un infisso di impedire infiltrazioni quando è investito da un flusso d'acqua ed è presente una differente pressione tra interno ed esterno.
Capacity of a window to prevent infiltrations when impacted by a gush of water and there is a different internal and external pressure.

Press.	0Pa5	0Pa	100Pa	150Pa	200Pa	250Pa	300Pa	450Pa	600Pa	750Pa	900Pa	1050Pa	1200Pa	1350Pa	1500Pa	Pressure
Velocità	03	24	55	56	47	27	89	6	111	126	138	149	159	169	178	Speed
Classe	- 1	A2	A3	A4	A5	A6	A7	A8	A	E750	E900	E1050	E1200	E1350	E1500	Class

L'infisso TWIN, con una pressione del vento pari ad una velocità di 178 Km/h (1500Pa) non ha avuto infiltrazioni
The frame TWIN with a wind pressure equal to a speed of 178 Km/h (1500Pa), had no infiltrations

Classe | Class
RE1200
EN 1027 - EN 12208

Tenuta all'Aria
Air Permeability



Caratteristica di un infisso chiuso di lasciare trarre aria quando è presente una differenza di pressione tra l'interno e l'esterno; minori saranno i volumi dispersi, maggiore sarà la qualità del serramento.
Characteristic of a closed window to let air filter through when there is a different internal and external pressure; the lower the dispersed volumes, the higher the quality of the frame.

Press.	150Pa	300Pa	450Pa	600Pa	Pressure
Classe	1	2	3	4	Class

L'infisso TWIN ha superato la prova con Pressione Vento = 111 k/h (600Pa)
The frame TWIN has passed the test with a Wind Pressure = 111 Km/h (600Pa)

Classe | Class
A4
EN 1026 - EN 12207

Resist. al Vento
Wind Resistance

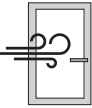

Capacità di un infisso sottoposto a forti pressioni e/o depressioni, come quelle causate dal vento, di mantenere una deformazione ammissibile, di conservare le proprietà iniziali a salvaguardia della sicurezza degli utenti.
Capacity of a window subject to high positive and/or negative pressures, like that caused by the wind, to maintain an admissible deformation, to conserve its initial properties and to safeguard users against breakage.

Press.	400Pa	800Pa	1200Pa	1600Pa	2000Pa	>2000Pa	Pressure
Flessione	A (≤ 1/150)	B (≤ 1/200)	C (≤ 1/300)				Flexure
Classe	12	34	5E	xxx			Class

* Serramento a 2 ante, dimensione L = mm.2034 ed H = mm.1950 - Certificato n° RP n° 1994-CPD-RP0510 (Altre Certificazioni Disponibili)
Double Casement window, dimension L = mm.2034 ed H = mm.1950 - Test certificate no. RP no. 1994-CPD-RP0510 (Other certifications available).

Perdita di isolamento acustico rispetto al vetro DR_w (dB) a partire dalla classe di permeabilità all'aria dell'infisso (UNI EN 12207)
Capacity of a window to resist violent intrusion following the application of a physical force or with the aid of tools.

Classe	1	2	3	4	Class
Perdita	8dB	6dB	4dB	2dB	Loss

Ammesso l'utilizzo di questo metodo tabellare
Admitted This table method

Necessario realizzare un campione al vero e sottoporre a prove di Laboratorio.
An actual sample must be made and tested in the laboratory.

Classe | Class
3000PA
EN 12211-EN 12210

Fonoisolamento
Sound Insulation



Trasmittanza
Transmittance



SECONDO TIPOLOGIA
AS PER TIPOLOGY

Abbattimento Acustico
Noise Reduction
45 dB
EN ISO140-3 | 717-1



IL CALCOLO DEL COEFFICIENTE DI TRASMITTANZA TERMICA

è definito nella norma EN 1394.

Nella figura seguente sono indicate le diverse superfici e le viste della facciata- ta nonché la terminologia da utilizzare.

Superfici delle facciate continue L'elemento-modello di riferimento viene suddiviso in superfici dalle differenti caratteristiche termiche (telaio fisso e anta apribile, montante, traverso, vetratura e pannelli).

LEGENDA:

- 1 MONTANTE**
- 2 TRAVERSO**
- 3 TELAIO FISSO E ANTA APRIBILE**
- 4 VETRATURA**
- 5 PANNELLO**

THE CALCULATION OF THE THERMAL TRANSMITTANCE COEFFICIENT
is defined in the EN 1394 standard.

The following figure shows the different facade surfaces and views as well as the terminology from use.

Surfaces of the curtain walls The reference model-element is divided into surfaces with different ones thermal characteristics (fixed frame and opening sash, mullion, transom, glazing and panels).

LEGEND:

- 1 UPRIGHT**
- 2 TRAVERSE**
- 3 FIXED FRAME AND OPENING DOOR**
- 4 GLAZING**
- 5 PANEL**

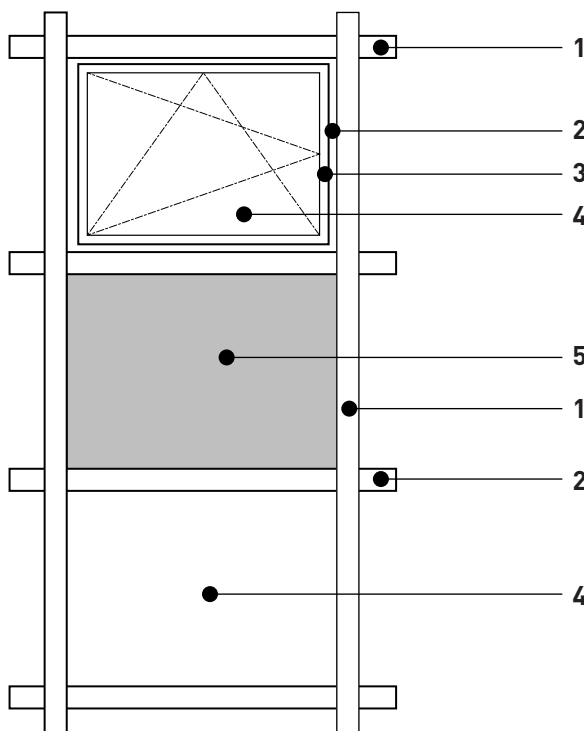

In questa sezione viene spiegato il procedimento di determinazione del coefficiente di trasmittanza termica della facciata con valutazione dei singoli componenti.

Il procedimento prevede la suddivisione di un elemento rappresentativo della facciata in parti di superficie dalle diverse caratteristiche termiche, ad es. vetratura, pannelli opachi e telaio. Grazie alla valutazione rapportata alla superficie dei valori U dei suddetti elementi utilizzando ulteriori fattori correttivi (valori Ψ) che descrivono l'interazione termica tra gli elementi stessi, è possibile determinare il valore U della facciata come unità complessiva. Questo procedimento è adatto per le strutture a montanti e traverse ma non per le vetrate strutturali.

This section explains the procedure for determining the thermal transmittance coefficient of the facade with assessment of individual components.

The procedure provides for the subdivision of a representative element of the facade into surface parts from different thermal characteristics, e.g. glazing, opaque panels and frame. Thanks to the reported evaluation to the surface of the U-values of the above elements using additional factors corrections (Ψ values) that describes the thermal interaction between the elements themselves, it is possible to determine the value U of the facade as an overall unit. This procedure is suitable for post and transom structures but not for structural glazing.



OBBLIGATORietà DELLA MARCATURA CE PER LE FACCIATE CONTINUE.

INFORMAZIONI GENERALI

Conformemente alla comunicazione apparsa sulla GUCE (gazzetta ufficiale europea), la marcatura CE di facciate continue, in ottemperanza alla norma di prodotto EN 13830, è obbligatoria. Una volta trascorsa la fase di coesistenza, dunque a partire dal dicembre 2005, tutte le norme nazionali attinenti allo stesso argomento devono essere ritirate dai rispettivi stati. Da questa data in poi le facciate continue devono essere contrassegnate con il marchio CE.

Norma di prodotto per le facciate continue EN 13830

I PUNTI DA RISPETTARE

- ◆ La marcatura ce per le facciate continue diventa obbligatoria per i paesi membri dell'unione europea a partire da dicembre 2005.
- ◆ La marcatura costituisce il presupposto per la messa in circolazione di un prodotto sul mercato europeo.
- ◆ Responsabile per la marcatura ce è colui che, secondo la direttiva ce, «mette in circolazione» la facciata continua, quindi l'azienda costruttrice.
- ◆ Facciate continue non contrassegnate o contrassegnate non correttamente non possono essere montate negli stati dell'unione europea.

PERCHÉ LA MARCATURA CE?

- ◆ Impedisce le barriere al commercio
- ◆ Un unico mercato europeo senza confini interni
- ◆ Prodotti sicuri ed esenti da rischi per la salute nell'ambito dell'utilizzo conforme alla destinazione d'uso prevista
- ◆ Attesta la conformità alla direttiva sui prodotti da costruzione (DPC) e il suo recepimento nell'ordinamento giuridico del paese di destinazione
- ◆ Creazione di procedure europee per la determinazione, la prova e la classificazione delle caratteristiche essenziali dei prodotti da costruzione. Dette caratteristiche vengono indicate con la marcatura CE.

CHE COSA SIGNIFICA LA MARCATURA CE?

La marcatura di un prodotto e/o dei documenti a corredo con il marchio CE ne attesta la conformità ai paragrafi armonizzati della corrispondente norma europea (EN) o della linea guida per il benessere tecnico europeo (ETAG). Questo significa che il prodotto può essere liberamente commercializzato in tutta Europa; tuttavia deve essere verificato se questo risponde ai requisiti del paese di destinazione.

La marcatura CE deve essere effettuata dall'azienda costruttrice. L'apposizione del marchio CE attesta l'idoneità del componente all'utilizzo previsto. Fondamento della marcatura CE è la norma di prodotto EN 13830. Tutte le misure necessarie ai fini della marcatura CE sono definite in questa norma. La conformità di facciate continue senza requisiti antifumo e/o anti-fumo ai dettami della norma deve essere attestata attraverso le seguenti misure: Le Prove iniziali di tipo (Initial Type Test/ITT) e Controllo di produzione in fabbrica CPF (Factory Production Control/FPC)

L'obbligo della marcatura è a carico dell'azienda costruttrice. Responsabile per la marcatura CE è colui che, secondo la direttiva CE «mette in circolazione» la facciata finita, quindi l'azienda costruttrice.

MANDATORY CE MARKING FOR CURTAIN FACADES.

GENERAL INFORMATION

In accordance with the communication published in the OJEC (European Official Journal), the CE marking of curtain walls, in compliance with the product standard EN 13830, is mandatory. Once the coexistence phase has elapsed, i.e. starting from December 2005, all the national standards related to the same subject must be withdrawn by the respective states. From this date on the facades continuous must be marked with the CE mark.

Product standard for curtain walls EN 13830

THE POINTS TO BE RESPECTED.

- ◆ **THE CE MARKING FOR CURTAIN WALLS BECOMES MANDATORY FOR THE MEMBER COUNTRIES OF THE EUROPEAN UNION STARTING FROM DECEMBER 2005.**
- ◆ **THE MARKING IS THE PREREQUISITE FOR PUTTING A PRODUCT INTO CIRCULATION ON THE EUROPEAN MARKET.**
- ◆ **RESPONSIBLE FOR THE CE MARKING IS THE PERSON WHO, ACCORDING TO THE CE DIRECTIVE, "PUTS INTO CIRCULATION" THE CURTAIN WALL, I.E. THE BUILDING COMPANY.**
- ◆ **UNMARKED OR INCORRECTLY MARKED CURTAIN WALLS CANNOT BE ERECTED IN EU STATES.**

WHY THE CE MARKING?

- ◆ **IT PREVENTS BARRIERS TO TRADE**
- ◆ **A SINGLE EUROPEAN MARKET WITHOUT INTERNAL BORDERS**
- ◆ **PRODUCTS THAT ARE SAFE AND FREE FROM HEALTH RISKS WHEN USED IN ACCORDANCE WITH THE INTENDED USE**
- ◆ **ATTESTS COMPLIANCE WITH THE CONSTRUCTION PRODUCTS DIRECTIVE (CPD) AND ITS TRANSPOSITION INTO THE LEGAL SYSTEM OF THE COUNTRY OF DESTINATION**
- ◆ **CREATION OF EUROPEAN PROCEDURES FOR THE DETERMINATION, TESTING AND CLASSIFICATION OF THE ESSENTIAL CHARACTERISTICS OF CONSTRUCTION PRODUCTS. THESE CHARACTERISTICS ARE INDICATED WITH THE CE MARKING.**

WHAT DOES THE CE MARKING MEAN?

Marking a product and/or accompanying documents with the CE mark certifies its compliance with the harmonized paragraphs of the corresponding European standard (EN) or the guideline for European technical approval (ETAG). This means that the product can be freely marketed throughout Europe; however it must be checked whether this meets the requirements of the country of destination.

The CE marking must be carried out by the manufacturer. The affixing of the CE mark certifies the suitability of the component for the intended use. The basis of the CE marking is the product standard EN 13830. All measures required for the purpose of CE marking are defined in this standard. The compliance of curtain walls without fireproof and/or smokeproof requirements with the dictates of the standard must be attested through the following measures: Initial Type Tests (ITT) and Factory Production Control/FPC (CPF)

The marking obligation is the responsibility of the manufacturer. Responsible for the CE marking is the person who, according to the CE directive, "puts" the finished facade into circulation, the building company.



REQUISITI PRESTAZIONALI E PROVE

La norma di prodotto definisce in base a quali norme devono essere rilevati, nell'ambito della prova iniziale di tipo (ITT), i valori di riferimento per queste caratteristiche. Per mezzo del controllo di produzione in fabbrica (CPF) deve essere garantito che le caratteristiche essenziali delle facciate riscontrate durante la prova iniziale di tipo (ITT) vengano effettivamente rispettate anche nella prassi produttiva all'interno della fabbrica. Dato che la norma prende in considerazione i requisiti di tutti i paesi dell'Unione Europea, può succedere che in alcuni stati membri determinate caratteristiche essenziali (come ad es. il comportamento al fuoco) non costituiscano un requisito. In questo caso l'azienda costruttrice non è obbligata ad accertare se la prestazione del suo prodotto risponda a questa caratteristica tramite prova iniziale di tipo e a riportarla nei relativi documenti.

Essa ha la possibilità di contrassegnare detta caratteristica sui documenti a corredo con npd (no performance determined) che significa «prestazione non determinata». Qualora tuttavia venga richiesta l'osservanza di determinati valori, allora si dovranno indicare i valori caratteristici di prestazione determinati durante la prova iniziale di tipo.

Per ridurre al minimo il dispendio di tempo e risorse a carico delle aziende costruttrici la RALOX ha fatto eseguire prove iniziali di tipo (ITT) da un ente di certificazione notificato.

PROVA INIZIALE DI TIPO (ITT) CONFORME ALLA NORMA EN

- ◆ In una prova iniziale di tipo vengono determinate le caratteristiche del prodotto tramite un campione.
- ◆ La prova iniziale di tipo può essere condotta per misurazione, calcolo o altri procedimenti.
- ◆ I requisiti per la prova iniziale di tipo (ITT) sono descritti nelle relative norme, per le facciate continue la norma pertinente è la EN 13830.
- ◆ Di solito è sufficiente testare un elemento rappresentativo di una famiglia di prodotti.
- ◆ L'esecuzione della prova iniziale di tipo va affidata ad un ente certificato. I dettagli a tale proposito sono contenuti nella norma di prodotto stessa.
- ◆ Eventuali scostamenti dall'elemento controllato non devono comportare un peggioramento delle caratteristiche prestazionali.
- ◆ L'azienda costruttrice può utilizzare, a determinate condizioni, le prove iniziali di tipo fatte dal fornitore di sistemi.

CARATTERISTICHE ESSENZIALI

Come già accennato nell'introduzione ai fini della marcatura CE devono essere considerate le caratteristiche essenziali. Tutte le altre caratteristiche che non hanno questo attributo non devono essere dichiarate nella marcatura CE. Dette caratteristiche vengono enumerate nel seguente estratto della norma di prodotto EN 13830.

PERFORMANCE REQUIREMENTS AND TESTS

The product standard defines according to which standards the reference values for these characteristics must be determined as part of the initial type test (ITT). By means of factory production control (CPF), it must be guaranteed that the essential characteristics of the facades found during the initial type test (ITT) are effectively respected also in the production practice within the factory. Since the standard takes into account the requirements of all European Union countries, it may happen that in some member states certain essential characteristics (such as fire behavior) do not constitute a requirement. In this case the manufacturing company is not obliged to ascertain whether the performance of its product responds to this characteristic through an initial type test and to report it in the relevant documents.

It has the possibility of marking this characteristic on the accompanying documents with npd (no performance determined) which means "performance not determined". However, if compliance with certain values is required, then the characteristic performance values determined during the initial type test must be indicated.

To minimize the waste of time and resources borne by manufacturing companies, RALOX had initial type tests (ITT) carried out by a notified certification body.

INITIAL TYPE TEST (ITT) COMPLIANT WITH THE EN STANDARD

- ◆ In an initial type test, the product characteristics are determined using a sample.
- ◆ The initial type test may be conducted by measurement, calculation or other procedures.
- ◆ The requirements for the initial type test (ITT) are described in the relevant standards, for curtain walls the relevant standard is EN 13830.
- ◆ Usually it is sufficient to test a representative element of a product family.
- ◆ The execution of the initial type test must be entrusted to a certified body. The details in this regard are contained in the product standard itself.
- ◆ Any deviations from the controlled element must not lead to a deterioration of the performance characteristics.
- ◆ Under certain conditions, the manufacturer can use the initial type tests carried out by the system supplier.

ESSENTIAL FEATURES

As already mentioned in the introduction, the essential characteristics must be considered for the purposes of CE marking. All other characteristics that do not have this attribute do not have to be declared in the CE marking. These characteristics are enumerated in the following extract of the EN 13830 product standard.



CARATTERISTICHE FONDAMENTALI FUNDAMENTAL CHARACTERISTICS	ESPRESSIONI DI PRESTAZIONE Expressions of Performance
Comportamento al FUOCO <i>Fire Behaviour</i>	Classi A1 fino a F <i>Classes A1 up to F</i>
Resistenza al FUOCO <i>Fire Resistance</i>	Classi EN 13501-2 <i>Classes EN 13501-2</i>
Propagazione dell'INCENDIO <i>Fire Spread</i>	-
Tenuta all'ACQUA <i>Watertightness</i>	Classi Tecniche <i>Technical Classes</i>
Resistenza al carico da PESO PROPRIO <i>Own Weight load Resistance</i>	KN <i>KN</i>
Resistenza al Carico del VENTO <i>Wind Load Resistance</i>	KN/m² <i>KN/sqm</i>
Resistenza all'URTO <i>Shock Resistance</i>	Classi Tecniche <i>Technical Classes</i>
Resistenza allo SHOCK TERMICO <i>Thermal Shock Resistance</i>	Tipo di Vetro <i>Type of Glass</i>
Resistenza ai carichi ORIZZONTALI <i>Resistance to Horizontal Loads</i>	KN <i>KN</i>
Permeabilità all'ARIA <i>AIR Permeability</i>	Classi Tecniche <i>Technical Classes</i>
Permeabilità al VAPORE ACQUEO* <i>Permeability to water vapour</i>	-
Trasmittanza termica <i>Heat Transmittance</i>	W/m²K
Isolamento ACUSTICO <i>Sound Proofing</i>	dB
Durabilità* <i>Durability</i>	-

*** = PER QUESTE CARATTERISTICHE NON ESISTONO SPECIALI INDICAZIONI DELLE PRESTAZIONI, TUTTAVIA LA CORRISPONDENZA CON LE RELATIVE SEZIONI SUI REQUISITI LASCIA SUPPORRE CHE CI SIA UNA CORRISPONDENZA CON IL PRESENTE ALLEGATO. PER QUESTO MOTIVO NON È NECESSARIA ALCUNA INFORMAZIONE RELATIVA ALLA MARCATURA CE.**

Il requisito relativo ad una determinata caratteristica non ha validità in quegli stati membri (SM) nei quali tale caratteristica essenziale non costituisce ai termini della legge un requisito per l'utilizzo conforme alla destinazione d'uso. In tal caso i fabbricanti che immettono i propri prodotti sul mercato dei suddetti SM non sono obbligati a definire o a indicare la prestazione dei loro prodotti per quel che concerne la caratteristica in questione, e possono indicare nella documentazione a corredo riguardante la marcatura CE «Prestazione non determinata» (npd). La possibilità di indicare npd tuttavia viene meno nel caso di caratteristiche con valori soglia.

*** = NO SPECIAL PERFORMANCE INDICATIONS EXIST FOR THESE CHARACTERISTICS, HOWEVER CORRESPONDENCE WITH THE RELEVANT REQUIREMENTS SECTIONS SUGGESTS THAT THERE IS A CORRESPONDENCE WITH THIS ATTACHMENT. FOR THIS REASON, NO CE MARKING INFORMATION IS REQUIRED.**

The requirement relating to a certain characteristic is not valid in those Member States (MS) in which this essential characteristic does not constitute a requirement for use in accordance with the intended use under the terms of the law. In this case, manufacturers who place their products on the market of the aforementioned MS are not obliged to define or indicate the performance of their products with regard to the characteristic in question, and may indicate in the accompanying documentation regarding the CE marking «Performance not determined» (npd). However, the possibility of indicating npd is lost in the case of characteristics with threshold values.



CASCADING ITT

Come risulta dal seguente quadro, nell'ambito del «cascading ITT» i fornitori di sistemi possono attivarsi al posto dei loro clienti (fabbricanti di facciate).

Il fornitore di sistemi, a conclusione della prova, è il «proprietario» dell'attestato ITT. Quindi egli può adesso delegare i proprio clienti (fabbricanti di facciate) ad utilizzare i suoi attestati ITT per la marcatura CE. A tale scopo riassume e stila tutte le prescrizioni per la lavorazione, il montaggio e il controllo di produzione in fabbrica che devono essere rispettate.

Il cliente (fabbricante di facciate) adesso può marcare i prodotti da lui fabbricati con il simbolo CE sulla scorta degli attestati ITT del fornitore di sistemi.

NOTA:

NEL «CASCADING ITT» È LAZIENDA COSTRUTTRICE A RISPONDERE DEL RISPETTO DEI VALORI DICHIARATI PER IL PRODOTTO DA ESSA FABBRICATO, OLTRE AD ESSERE RESPONSABILE PER L'INTRODUZIONE DI UN IDONEO CONTROLLO DI PRODUZIONE IN FABBRICA.

CASCADING ITT

As can be seen from the following overview, system suppliers can act on behalf of their customers (facade manufacturers) in the context of "ITT cascading".

At the end of the test, the system supplier is the "owner" of the ITT certificate. Therefore he can now delegate his customers (facade manufacturers) to use his ITT certificates for CE marking. For this purpose he summarizes and draws up all the regulations for processing, assembly and production control in the factory that must be respected.

The customer (façade manufacturer) can now mark the products he manufactures with the CE symbol based on the ITT certificates of the system supplier.

NOTE:

IN «ITT CASCADING» IT IS THE MANUFACTURING COMPANY THAT IS RESPONSIBLE FOR COMPLIANCE WITH THE DECLARED VALUES FOR THE PRODUCT IT MANUFACTURES, AS WELL AS BEING RESPONSIBLE FOR INTRODUCING APPROPRIATE FACTORY PRODUCTION CONTROLS.

MARCHIO CE SULLA BASE DI CE MARK BASED ON	FABBRICANTE ITT Manufacturer ITT	CASCADING ITT Cascading ITT	
ITT - Prove Iniziali di tipo <i>ITT - Initial Type Test</i>	H - Seleziona un campione rappresentativo e commissiona una ITT <i>H - Select a representative sample and commission an ITT</i>	S - Seleziona un campione rappresentativo, commissiona l'ITT, definisce sistema e CPF (ingl:FPC) <i>S - Select a representative sample, commission the ITT, define system and FPC</i>	
	NP - Controlla <i>NP - Check it out</i>	NP - Controlla <i>NP - Check it out</i>	
	H - Possessore <i>H - Owner</i>	S - Possessore del rapporto ITT <i>S - Holder of the ITT report</i>	
			H - È autorizzato ad utilizzare l'attestazione ITT di P <i>H - Is authorized to use the ITT attestation of P</i>
			Contratto tra H e S <i>Contract between H and S</i>
			Nessun peggioramento delle caratteristiche del Prodotto <i>No deterioration of the Product characteristics</i>
			Direttive di lavorazione di S rilevanti per H <i>Processing directives of S relevant to H</i>
		S verifica se H può eseguire la lavorazione <i>Processing directives of S relevant to H</i>	
		H può utilizzare l'attestazione ITT di S <i>H can use the ITT attestation of S</i>	
Controllo Produzione di Fabbrica (CPF) <i>Factory Production Control (FPC)</i>	L'adozione dell'CPF e la garanzia della sua applicaz. sono compito di H <i>Adopting FPC and ensuring its application is the task of H</i>		
Propagazione dell'INCENDIO <i>Fire Spread</i>	H è responsabile della marcatura e delle caratteristiche <i>H is responsible for marking and characteristics</i>		



CARATTERISTICHE DEL CPF SONO:

- ◆ Regolamenti aziendali e procedure idonei a garantire tutte le caratteristiche dichiarate col marchio CE (i requisiti e le prescrizioni devono avere valore vincolante)
- ◆ Responsabile della qualità con attitudine tecnica e potere dispositivo
- ◆ Controlli
- ◆ Provvedimenti in caso di non conformità

I PUNTI FONDAMENTALI DEL CONTROLLO DI PRODUZIONE IN FABBRICA SONO COSTITUITI DALLA VERIFICA DI:

- ◆ Materiali grezzi e componenti (materiali acquistati)
- ◆ Processi produttivi fondamentali per la qualità
- ◆ Prodotto finito, oltre ad un corretto imballaggio e magazzinaggio

REQUISITI:

- ◆ Gli strumenti di misura devono essere calibrati a intervalli regolari
- ◆ Deve essere garantita la rintracciabilità/identificazione dei prodotti
- ◆ I controlli devono essere documentati in quantità congrua
- ◆ La documentazione deve essere conservata (5 anni)

DOCUMENTAZIONE

QUALI DOCUMENTI VANNO PRODOTTI?

Con la prova iniziale di tipo e il controllo di produzione in fabbrica (CPF) l'azienda costruttrice ha creato i presupposti per la fabbricazione di un prodotto a norma.

Come precedentemente affermato, è il fabbricante, dunque l'azienda costruttrice, il responsabile della marcatura CE. E dunque sarà l'azienda medesima a dover produrre la documentazione necessaria per la marcatura CE. Quali siano questi documenti è definito nella rispettiva norma di prodotto (tabella a seguire), la quale descrive anche il contenuto di detti documenti. Con essi l'azienda costruttrice conferma che il prodotto da costruzione da essa fabbricato è a norma e quindi può essere immesso sul mercato.

PROCEDURA DI CONFORMITÀ COMPLIANCE PROCEDURE	MARCATURA CE INCL DOCUMENTAZIONE CE MARKING INCL. DOCUMENTATIONS	DICHIARAZIONE DI CONFORMITÀ CE CE DECLARATION OF CONFORMITY	CERTIFICATO DI CONFORMITÀ CE CE CERTIFICATE OF CONFORMITY
3	-	-	-

DICHIARAZIONE DI CONFORMITÀ CE

Se il prodotto da costruzione risponde ai requisiti della norma l'azienda costruttrice deve emettere la cosiddetta dichiarazione di conformità CE, con la quale attesta che le facciate da essa fabbricate soddisfano i requisiti della norma EN 13830 e che quindi l'azienda ha il diritto di «apporre il marchio CE». La dichiarazione di conformità CE rimane per 10 anni presso il fabbricante (obbligo di conservazione).

IMPORTANTE: ESSA DEVE ESSERE REDATTA NELLA LINGUA UFFICIALE DEL PAESE NEL QUALE IL PRODOTTO DA COSTRUZIONE VIENE MESSO IN CIRCOLAZIONE E DEVE ESSERE PROVISTA DI FIRMA LEGALMENTE VALIDA (TITOLARE, AMMINISTRATORE DELEGATO).

CHARACTERISTICS OF THE CPF ARE:

- ◆ Company regulations and procedures suitable for guaranteeing all the characteristics declared with the CE mark (requirements and prescriptions must have binding value)
- ◆ Quality manager with technical aptitude and device power
- ◆ Checks
- ◆ Measures in case of non-compliance

THE FUNDAMENTAL POINTS OF FACTORY PRODUCTION CONTROL CONSIST OF THE VERIFICATION OF:

- ◆ Raw materials and components (purchased materials)
- ◆ Production processes essential for quality
- ◆ Finished product, as well as proper packaging and storage

REQUIREMENTS:

- ◆ Measuring instruments must be calibrated at regular intervals
- ◆ The traceability/identification of the products must be guaranteed
- ◆ Controls must be documented in appropriate quantities
- ◆ Documentation must be kept (5 years)

DOCUMENTATION

WHAT DOCUMENTS MUST BE PRODUCED?

With the initial type test and factory production control (CPF), the manufacturer has created the prerequisites for the manufacture of a standard-compliant product.

As previously stated, the manufacturer, therefore the manufacturing company, is responsible for the CE marking. And therefore it will be the company itself that will have to produce the necessary documentation for the CE marking. What these documents are is defined in the respective product standard (following table), the which also describes the content of said documents. With them, the manufacturing company confirms that the construction product it manufactures complies with the law and can therefore be placed on the market.

CE DECLARATION OF CONFORMITY

If the construction product meets the requirements of the standard, the manufacturing company must issue the so-called CE declaration of conformity, with which it certifies that the facades it manufactures meet the requirements of the EN 13830 standard and that therefore the company has the right to «affix the CE mark». The EC declaration of conformity remains with the manufacturer for 10 years (retention obligation).

IMPORTANT: IT MUST BE DRAWN UP IN THE OFFICIAL LANGUAGE OF THE COUNTRY IN WHICH THE CONSTRUCTION PRODUCT IS PUT INTO CIRCULATION AND MUST HAVE A LEGALLY VALID SIGNATURE (OWNER, MANAGING DIRECTOR).



NEL DOCUMENTO CAMPIONE RAFFIGURATO SONO RIPORTATE TUTTE LE INFORMAZIONI CHE IN BASE ALLA NORMA EN 13830 DEVONO ESSERE CONTENUTE IN UNA DICHIARAZIONE DI CONFORMITÀ CE.

QUESTE SONO LE INFORMAZIONI CHE DEVONO ESSERVI CONTENUTE, IN OTTEMPERANZA ALLA NORMA EN 13830:

- ◆ Nome e indirizzo dell'azienda costruttrice o del suo rappresentante autorizzato residente nell'area economica europea e luogo di produzione
- ◆ Descrizione del prodotto (tipo, marcatura, utilizzo ecc.) e copia della documentazione di accompagnamento alla marcatura CE
- ◆ Condizioni particolari alle quali l'utilizzo del prodotto è soggetto e Prescrizioni alle quali il prodotto deve ottemperare
- ◆ Nome ed indirizzo dell'ente notificato
- ◆ Nome e posizione della persona autorizzata alla firma della dichiarazione in nome del fabbricante o del suo rappresentante autorizzato.

MARCATURE CE

Documento di accompagnamento del prodotto per l'impresa edile. La dichiarazione di conformità CE rimane presso l'azienda costruttrice. Al di fuori di quest'ultima la conformità del prodotto da costruzione alle condizioni normative viene espressa con il marchio CE. Il marchio non necessariamente deve essere apposto sul componente stesso. È possibile effettuare anche la marcatura sui documenti accompagnatori come ad es. il documento di trasporto oppure sulle istruzioni per l'uso e la manutenzione. Anche in questo caso la norma EN 13830 stabilisce quali sono le informazioni necessarie che devono esservi contenute.

QUESTE SONO LE INFORMAZIONI CHE DEVONO ESSERVI CONTENUTE, IN OTTEMPERANZA ALLA NORMA EN 13830:

- ◆ Nome ed indirizzo o marchio registrato dell'azienda costruttrice
- ◆ Le ultime due cifre dell'anno in cui il marchio è stato apposto
- ◆ Il riferimento alla suddetta norma europea (EN 13830)
- ◆ Descrizione del prodotto: denominazione, materiale, misure ecc. oltre alla destinazione d'uso
- ◆ Dati relativi alle caratteristiche essenziali prescritte come da tabella ZA.1, da riportare come segue: valori riscontrati e, se pertinenti, livelli o classi (inclusa, se necessario, la dicitura «superato» nei requisiti che prevedono la formula «superato/non superato») per ogni caratteristica prescritta, conformemente alla tabella ZA.1, tenendo in considerazione la «nota» della tabella stessa: «prestazione non determinata»

L'OPZIONE «PRESTAZIONE NON DETERMINATA» (NPD) NON PUÒ ESSERE UTILIZZATA QUANDO LA CARATTERISTICA È SOGGETTA AD UN VALORE SOGLIA. SE LA CARATTERISTICA, PER UN DETERMINATO USO, NON È SOGGETTA A REQUISITI PRESCRITTI DALLE AUTORITÀ, ALLORA L'OPZIONE NPD PUÒ ESSERE USATA.

RESISTENZA AI CARICHI DEL VENTO

DIN EN 12210

Le facciate continue devono essere sufficientemente stabili per poter resistere, sottoposte a prova conforme alla norma EN 12179, ai carichi del vento applicati sia in pressione che in depressione che costituiscono la base di riferimento progettuale per l'idoneità d'uso. Per mezzo di adeguati elementi di fissaggio esse devono

THE SAMPLE DOCUMENT SHOWN CONTAINS ALL THE INFORMATION WHICH, ACCORDING TO THE EN 13830 STANDARD, MUST BE CONTAINED IN AN EC DECLARATION OF CONFORMITY.

THIS IS THE INFORMATION THAT MUST BE CONTAINED IN:

- ◆ Name and address of the manufacturing company or its authorized representative residing in the European Economic Area and place of production
- ◆ Product description (type, marking, use, etc.) and copy of the documentation accompanying the CE marking
- ◆ Particular conditions to which the use of the product is subject and Prescriptions with which the product must comply
- ◆ Name and address of the notified body
- ◆ Name and position of the person authorized to sign the declaration on behalf of the manufacturer or his authorized representative.

CE MARKING

Document accompanying the product for the construction company. The CE declaration of conformity remains with the manufacturer. Outside of the latter, the compliance of the construction product with regulatory conditions is expressed with the CE mark. The mark does not necessarily have to be affixed to the component itself. Marking on is also possible accompanying documents such as the transport document or on the instructions for use and maintenance. Also in this case, the EN 13830 standard establishes which information is necessary and must be contained therein.

THIS IS THE INFORMATION THAT MUST BE CONTAINED, IN COMPLIANCE WITH THE EN 13830 STANDARD:

- ◆ Name and address or registered trademark of the manufacturing company
- ◆ The last two digits of the year in which the mark was affixed
- ◆ The reference to the aforementioned European standard (EN 13830)
- ◆ Product description: designation, material, dimensions, etc. in addition to the intended use
- ◆ Data relating to the essential characteristics prescribed as per table ZA.1, to be reported as follows: values found and, if relevant, levels or classes (including, if necessary, the wording "passed" in the requirements which include the formula "pass/fail") for each characteristic prescribed, in accordance with table ZA.1, taking into account the "note" of the table itself: "performance not determined"

THE «PERFORMANCE NOT DETERMINED» (NPD) OPTION CANNOT BE USED WHEN THE CHARACTERISTIC IS SUBJECT TO A THRESHOLD VALUE. IF THE FEATURE, FOR A GIVEN USE, IS NOT SUBJECT TO REQUIREMENTS PRESCRIBED BY THE AUTHORITIES, THEN THE NPD OPTION CAN BE USED.

WIND LOAD RESISTANCE

DIN EN 12210

Curtain walls must be sufficiently stable to be able to resist, subjected to tests in compliance with standard EN 12179, the wind loads applied both in pressure and in depression which constitute the design reference basis for suitability for use. By means of suitable fastening elements they must be able to transfer wind loads to the supporting structure. Suitable fastening elements must be able to transfer wind loads to the supporting structure of the building. The decisive wind loads result from the test carried out in accordance with EN 12179.

During the measurement carried out in compliance with the EN 13116



essere in grado di trasferire i carichi del vento alla struttura portante dell'edificio. I carichi del vento determinanti risultano dalla prova eseguita in conformità alla norma EN 12179. Durante la misurazione eseguita conformemente alla norma EN 13116 la deformazione elastica massima degli elementi di telaio della facciata, rilevata tra due successivi punti di vincolo alla struttura dell'edificio, non può superare, sotto l'azione dei carichi di test, $L/200$ o 15 mm, a seconda di quale dei due è più basso.

TENUTA ALL'ACQUA

DIN EN 12208

La tenuta all'acqua delle facciate viene testata in conformità alla norma EN 12155.

È necessario che la costruzione sia a tenuta d'acqua affinché anche in caso di forti piogge con elevata pressione del vento l'involucro dell'edificio rimanga impermeabile, evitando che l'acqua vi penetri e possa arrecarvi danni.

DIN EN 12207

La permeabilità all'aria delle facciate viene testata in conformità alla norma EN 12153. La tenuta all'aria dei componenti è importante per prevenire scambi accidentali d'aria e di energia attraverso l'involucro edilizio. Con una facciata impermeabile all'aria le perdite energetiche vengono minimizzate e si evita la formazione accidentale di correnti d'aria.

standard, the maximum elastic deformation of the frame elements of the mm, whichever is lower.

Façade, detected between two successive points of constraint to the building structure, cannot exceed, under the action of the test loads, $L/200$ or 15 mm, whichever is lower.

WATERPROOF

DIN EN 12208

The watertightness of the facades is tested in accordance with the EN 12155 standard.

It is necessary that the construction is watertight so that even in the event of heavy rains with high wind pressure, the building envelope remains waterproof, preventing water from penetrating and causing damage.

DIN EN 12207

The air permeability of the facades is tested in accordance with the EN 12153 standard. The airtightness of the components is important to prevent accidental exchanges of air and energy through the building envelope. With an airtight façade, energy losses are minimized and the accidental formation of drafts is avoided.



I limiti dell'Allegato A sul coefficiente medio globale di scambio termico per trasmissione per unità di superficie disperdente HT' sono da rispettare anche per gli interventi di ristrutturazione importante di secondo livello.

Nell'ambito degli interventi di ristrutturazione importante di secondo livello e degli interventi di riqualificazione energetica sono invece da rispettare i limiti riportati nell'Appendice B del decreto relativamente:

- **ALLA TRASMITTANZA TERMICA U_w DEI SERRAMENTI (TRASPARENTI, OPACHI) E DEI CASSONETTI POSTI A DELIMITAZIONE DI AMBIENTI CLIMATIZZATI VERSO L'ESTERNO OPPURE VERSO AMBIENTI NON CLIMATIZZATI (CFR. TABELLA 1);**
- **AL FATTORE DI TRASMISSIONE SOLARE TOTALE G_{GL+SH} DEI SERRAMENTI VETRATI IN COMBINAZIONE CON SCHERMATURE SOLARI MOBILI POSIZIONATI SUI FRONTI DELL'EDIFICIO SUD, EST, OVEST, SUD-EST, SUD-OVEST (CFR. TABELLA 2).**

The limits of Annex A on the overall average coefficient of heat exchange through transmission by unit of dispersant surface HT' must also be respected for major second-level renovations.

In the case of major second level renovations and energy upgrading works, the limits set out in Appendix B of the decree must be respected for:

- **HEAT TRANSMISSION U_w OF THE WINDOWS (TRANSPARENT, OPAQUE) AND SHUTTER BOXES POSITIONED TO DELIMIT AIR-CONDITIONED ENVIRONMENTS TOWARDS THE OUTSIDE OR TOWARDS NON-CONDITIONED ENVIRONMENTS (SEE TABLE 1);**
- **THE TOTAL SOLAR TRANSMISSION FACTOR G_{GL+SH} GLAZED WINDOWS IN COMBINATION WITH MOBILE SOLAR SHIELDS POSITIONED ON THE SOUTH, EAST, WEST, SOUTH-EAST, SOUTH-WEST BUILDING FAÇADES (SEE TABLE 2).**

Tabella/Table 1

Valori limite della trasmittanza U_w dei serramenti (trasparenti, opachi) e dei cassonetti posti a delimitazione di ambienti climatizzati verso l'esterno oppure verso ambienti non climatizzati.

ZONA CLIMATICA	U_w [W/m ² K]	
	2021	ECOBONUS
Zona A	3.00	2.60
Zona B	3.00	2.60
Zona C	2.00	1.75
Zona D	1.80	1.67
Zona E	1.40	1.30
Zona F	1.00	1.00

Tabella/Table 2

Valori limite del fattore di trasmissione solare totale g_{gl+sh} chiusure trasparenti in presenza di schermature solari mobili installate su fronti dell'edificio SUD, EST, OVEST, SUD-EST, SUD-OVEST

ZONA CLIMATICA CLIMATIC ZONE	G_{GL+SH}
	2021
Zone TUTTE ALL ZONES	0.35

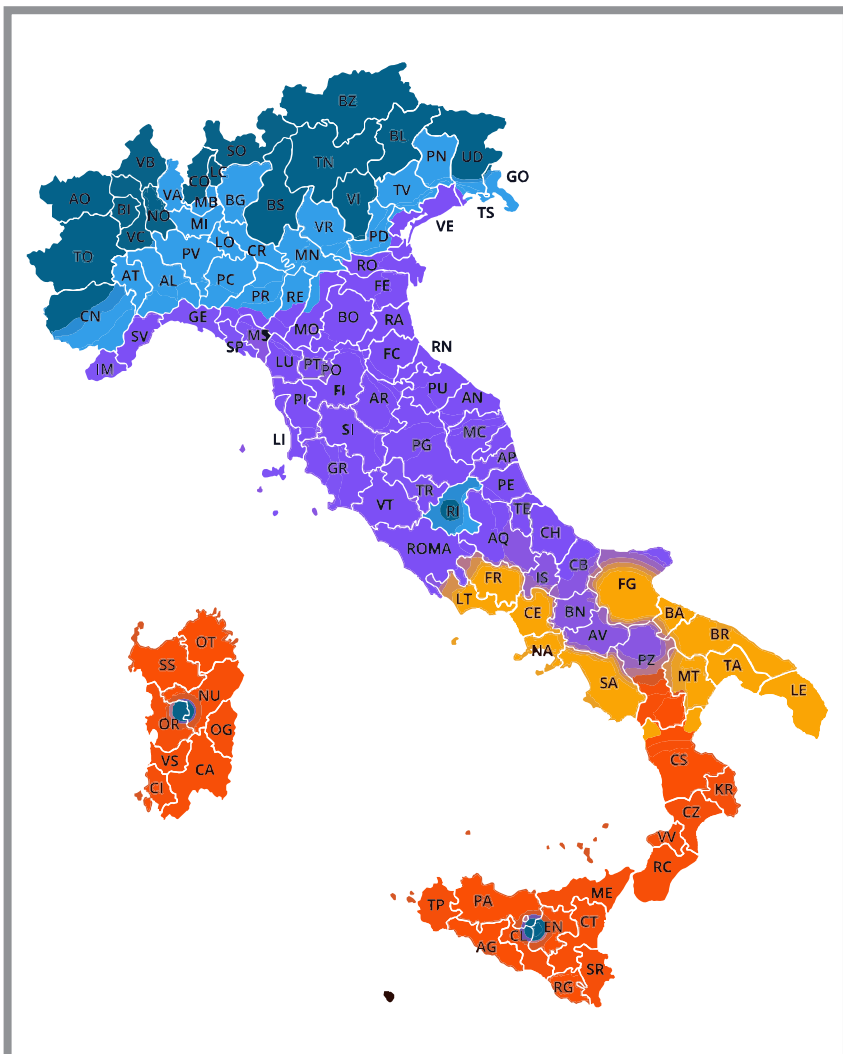



TRASMITTANZA TERMICA

Procedimento con valutazione dei singoli componenti

GENERALITÀ

Il coefficiente di trasmittanza termica di un singolo elemento della facciata continua UCW si calcola con la seguente equazione:

$$UCW = LA_g x U_g + LA_p x U_p + LA_f x U_f + LA_m x U_m + LA_t x U_t + LI_{f,g} x X_{f,g} + LI_{m,g} x X_{m,g} + LI_{t,g} x X_{t,g} + LI_p x X_p + LI_{m,f} x X_{m,f} + LI_{t,f} x X_{t,f}$$

LEGENDA:

- Ug Up = Coefficiente di trasmittanza termica della vetratura e del pannello
- Uf Um Ut = Coefficiente di trasmittanza termica del telaio, del montante e della traverso
- f,g m,g t,g p = Coefficiente di trasmittanza termica lineare risultante dagli effetti termici combinati di vetratura o pannello e di telaio o montante o traverso.

ACW = AG + AP + AF + AM + AT

Coefficiente di trasmittanza termica lineare risultante dagli effetti termici combinati di telaio-montante e telaio-anta.

LEGENDA:

- Acw = superficie della facciata continua
- Ag = superficie della vetratura
- Ap = superficie del pannello
- Af = superficie del telaio
- Am = superficie del montante
- At = superficie della traverso
- Am,i = superficie del montante, lato interno
- Am,e = superficie del montante, lato esterno
- Af,e = superficie del telaio, lato esterno

RIEPILOGO DEL PROCEDIMENTO PER LA DETERMINAZIONE DEL VALORE UCW DI UNA FACCIATA CONTINUA

PROCEDIMENTO CON VALUTAZIONE DEI SINGOLI COMPONENTI

1. Telaio

- 1.1 Definizione e valutazione delle superfici
- 1.2 Valutazione dei valori Uf, Um e Ut in conformità alla norma EN ISO 10077-2 (con equazione) oppure EN 12412-2
- 1.3 Valutazione dei valori di m,f,t,f in conformità alla norma EN 13947 oppure EN ISO 10077-2

2. Vetratura

- 2.1 Definizione e e valutazione delle superfici conformemente alla norma
- 2.2 Valutazione dei valori di Ug in conformità alla norma EN ISO 10077-1 oppure EN 673 EN 674 EN 675
- 2.3 Valutazione dei valori di t,g,m,g e f,g in conformità alla norma EN 13947 oppure EN ISO 10077-2

3. Pannelli

- 3.1 Definizione e valutazione delle superfici
- 3.2 Valutazione dei valori di Up in conformità alla norma EN ISO 6946
- 3.3 Valutazione dei valori di p in conformità alla norma EN 13947 oppure EN ISO 10077-2

4. Elementi interi

- 4.1 Calcolo degli elementi interi in base all'equazione riportata nella norma EN 13947

5. Facciata continua come unità complessiva

- 5.1 Calcolo di una facciata composta da differenti elementi secondo l'equazione contenuta nella norma EN 13947

THERMAL TRANSMITTANCE

Procedure with evaluation of individual components

GENERALITY

The thermal transmittance coefficient of a single element of the UCW curtain wall is calculated with the following equation:

$$UCW = LA_g x U_g + LA_p x U_p + LA_f x U_f + LA_m x U_m + LA_t x U_t + LI_{f,g} x X_{f,g} + LI_{m,g} x X_{m,g} + LI_{t,g} x X_{t,g} + LI_p x X_p + LI_{m,f} x X_{m,f} + LI_{t,f} x X_{t,f}$$

LEGEND:

- ♦ Ug Up = Thermal transmittance coefficient of the glazing and the panel
- ♦ Uf Um Ut = Thermal transmittance coefficient of the frame, upright and transom
- ♦ f,g m,g t,g p = Linear thermal transmittance coefficient resulting from the combined thermal effects of the glazing or panel and the frame or upright or transom.

ACW = AG + AP + AF + AM + AT

Coefficiente di trasmittanza termica lineare risultante dagli effetti termici combinati di telaio-montante e telaio-anta.

LEGEND:

- ♦ Ag = superficie della vetratura
- ♦ Ap = superficie del pannello
- ♦ Af = superficie del telaio
- ♦ Am = superficie del montante
- ♦ At = superficie della traverso
- ♦ Am,i = superficie del montante, lato interno
- ♦ Am,e = superficie del montante, lato esterno
- ♦ Af,e = superficie del telaio, lato esterno

RIEPILOGO DEL PROCEDIMENTO PER LA DETERMINAZIONE DEL VALORE UCW DI UNA FACCIATA CONTINUA

PROCEDIMENTO CON VALUTAZIONE DEI SINGOLI COMPONENTI

1. Telaio

- 1.1 Definizione e valutazione delle superfici
- 1.2 Valutazione dei valori Uf, Um e Ut in conformità alla norma EN ISO 10077-2 (con equazione) oppure EN 12412-2
- 1.3 Valutazione dei valori di m,f,t,f in conformità alla norma EN 13947 oppure EN ISO 10077-2

2. Vetratura

- 2.1 Definizione e e valutazione delle superfici conformemente alla norma
- 2.2 Valutazione dei valori di Ug in conformità alla norma EN ISO 10077-1 oppure EN 673 EN 674 EN 675
- 2.3 Valutazione dei valori di t,g,m,g e f,g in conformità alla norma EN 13947 oppure EN ISO 10077-2

3. Pannelli

- 3.1 Definizione e valutazione delle superfici
- 3.2 Valutazione dei valori di Up in conformità alla norma EN ISO 6946
- 3.3 Valutazione dei valori di p in conformità alla norma EN 13947 oppure EN ISO 10077-2

4. Elementi interi

- 4.1 Calcolo degli elementi interi in base all'equazione riportata nella norma EN 13947

5. Facciata continua come unità complessiva

- 5.1 Calcolo di una facciata composta da differenti elementi secondo l'equazione contenuta nella norma EN 13947



RESISTENZA ALL'URTO

La resistenza all'urto delle facciate viene testata in conformità alla norma EN 12600. I valori devono essere classificati sulla scorta della norma EN 14019.

Per l'esecuzione di questa prova viene impiegato uno pneumatico gemellato dalla massa di 50 kg con una pressione di 0,35 MPa che viene lanciato con movimento a pendolo sulla struttura da una determinata altezza. Questi i punti caratteristici da sollecitare: punto medio montante, punto medio traverso, intersezioni montanti/traversi, punto centrale elemento di riempimento.

INDICE DI ISOLAMENTO ACUSTICO STIMATO RW

L'isolamento acustico prevede misure volte alla diminuzione della trasmissione del suono da una sorgente all'ascoltatore. Nel caso dell'isolamento acustico la sorgente del rumore e l'ascoltatore si trovano in vani differenti; esso descrive la resistenza offerta da un componente (parete, soffitto o porta) all'attraversamento del suono. Detta resistenza è misurata in Decibel = dB ed è riferita all'indice di isolamento acustico R e alla differenza di livello sonoro.

L'indice di isolamento acustico R indica l'isolamento acustico dei componenti. La misurazione viene effettuata in laboratorio in conformità alla norma EN 20140-3 e vengono rilevate le caratteristiche acustiche per ogni terza d'ottava tra 100 e 3150 Hz (16 valori).

L'indice di isolamento acustico stimato R_w pondera i 16 valori di misurazione di R in base al loro effetto sull'orecchio umano.

R_w rappresenta il valore ottenuto in laboratorio.

I valori di adattamento allo spettro C e C_{tr} servono da fattori di correzione per particolari situazioni di rumore.

C descrive il caso di un utilizzo di appartamento tipico, con fonti di rumore a media ed alta frequenza (conversazione, bambini, radio, TV) e C_{tr} il caso di rumore da traffico con fonti a bassa e media frequenza (traffico cittadino, traffico su rotaie a bassa velocità, aerei ad elica, turbogetti a grande distanza).

IMPACT RESISTANCE

The impact resistance of the facades is tested in accordance with the EN 12600 standard. The values must be classified according to the EN 14019 standard.

For the execution of this test, a twin tire with a mass of 50 kg and a pressure of 0.35 MPa is used, which is launched with a pendulum movement on the structure from a given height. These are the characteristic points to be stressed: upright midpoint, transom midpoint, upright/transom intersections, central point of filling element.

ESTIMATED SOUND INSULATION INDEX RW

Acoustic insulation involves measures aimed at reducing the transmission of sound from a source to the listener. In the case of acoustic insulation, the source of the noise and the listener are in different rooms; it describes the resistance offered by a component (wall, ceiling or door) when crossing the sound. This resistance is measured in decibels = dB and refers to the acoustic insulation index R and the difference in sound level.

The sound insulation index R indicates the sound insulation of the components. The measurement is carried out in the laboratory in compliance with the EN 20140-3 standard and the acoustic characteristics are detected for each third of an octave between 100 and 3150 Hz (16 values).

The estimated sound insulation index R_w weights the 16 measured values of R according to their effect on the human ear.

R_w represents the value obtained in the laboratory.

The spectral adaptation values C and C_{tr} serve as correction factors for particular noise situations.

C describes the case of the use of a typical apartment, with medium and high frequency noise sources (conversation, children, radio, TV) and C_{tr} the case of traffic noise with low and medium frequency sources (city traffic, low-speed rail traffic, propeller planes, long-distance turbojets).



**TRAVERSO SU TRE APPOGGI
VERIFICA DEL MONTANTE AI CARICHI DI
VENTO.**

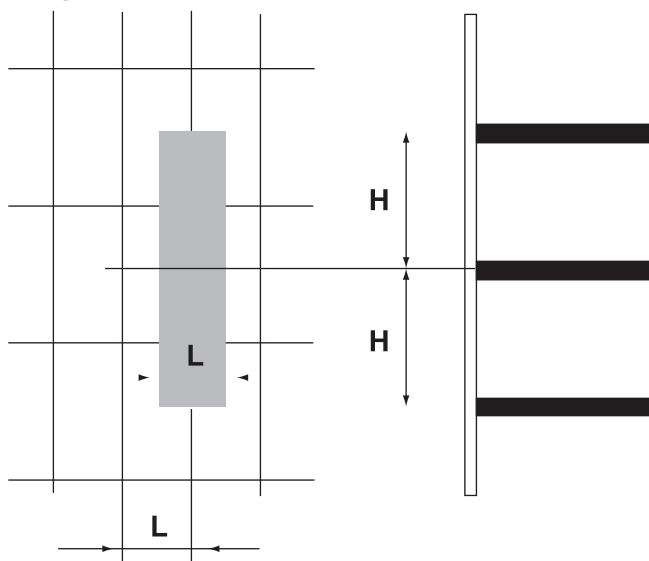

**BEAM ON THREE SUPPORTS
MULLION VERIFICATION ON WIND LOADS.**

$$f_{\max} = \frac{2}{369} \cdot \frac{qLH^4}{EJ} \leq f_{\text{amm}}$$

$$s_{\max} = \frac{1}{8} \cdot \frac{qLH^2}{W} \leq s_{\text{amm}}$$

Calcolo della freccia max e della sigma max con trave su tre appoggi.

Calculation of max deflection and max sigma with the beam on three support.

SIMBOLOGIA / SYMBOLS

H	Interasse solaio / <i>Floor centre line</i>	cm
L	Interasse montanti / <i>Mullion centre distances</i>	cm
q	Pressione cinetica del vento / <i>Wind kinetic pressure</i>	Kg/cm ²
E	Modulo di elasticità / <i>Modulus of elasticity</i>	Kg/cm ² 700000 per l'alluminio Kg/cm ² 700000 for aluminium
J	Momento d'inerzia / <i>Moment of inertia</i>	cm ⁴
W	Modulo di resistenza minimo / <i>Minimum section modulus</i>	cm ³
f_{max}	Freccia massima / <i>Maximum deflection</i>	cm
s_{max}	Tensione normale massima / <i>Maximum normal tension</i>	Kg/cm ²
f_{amm}	Freccia ammissibile / <i>Allowed deflection</i>	cm
s_{amm}	Tensione normale ammissibile / <i>Normal allowed tension</i>	Kg/cm ²

**LIMITI DI IMPIEGO. TRAVERSO SU TRE
APPOGGI.**

Il dimensionamento risultante dal grafico è solo indicativo. Il progettista o il serramentista, nel determinare le dimensioni massime della facciata, dovrà considerare e valutare, oltre le dimensioni ed il momento d'inerzia dei profilati, anche le caratteristiche applicative e meteorologiche quali l'altezza dal suolo, l'esposizione alla pioggia e la velocità dei venti nella zona.

Per questi dati consigliamo di consultare e seguire le "Raccomandazioni UNCSAAL" elaborate sulla base delle norme UNI, UNI-EN e UNI-CNR esistenti in merito. Verificare che la freccia del profilato sia compatibile con quella del vetro utilizzato.

Le curve rappresentano l'interasse tra i montanti in funzione della distanza fra i solai.

Le curve sono calcolate sulla base della deformazione elastica di L/200 o di 15mm. del serramento.

**LIMITS OF USE. BEAM ON THREE
SUPPORTS.**

In determining the maximum dimensions of the facade, in addition to the dimensions and moment of inertia of the profiles, the designer or manufacturer must also consider and evaluate the application and meteorological conditions such as the height from the ground, exposure to rain and the speed of the winds in the area.

For these data, we recommend consulting and following the "UNCSAAL Recommendations" drawn up on the basis of the relative UNI, UNI-EN and UNI-CNR standards. Check that the arrow on the profile is compatible with the arrow on the glass used.

The curves represent the distance between the uprights as a function of the distance between the floors.

The curves are calculated on the basis of the elastic deformation of L/200 or 15mm. of the window.



MONTANTE SU TRE APPOGGI
MULLION ON THREE SUPPORTS

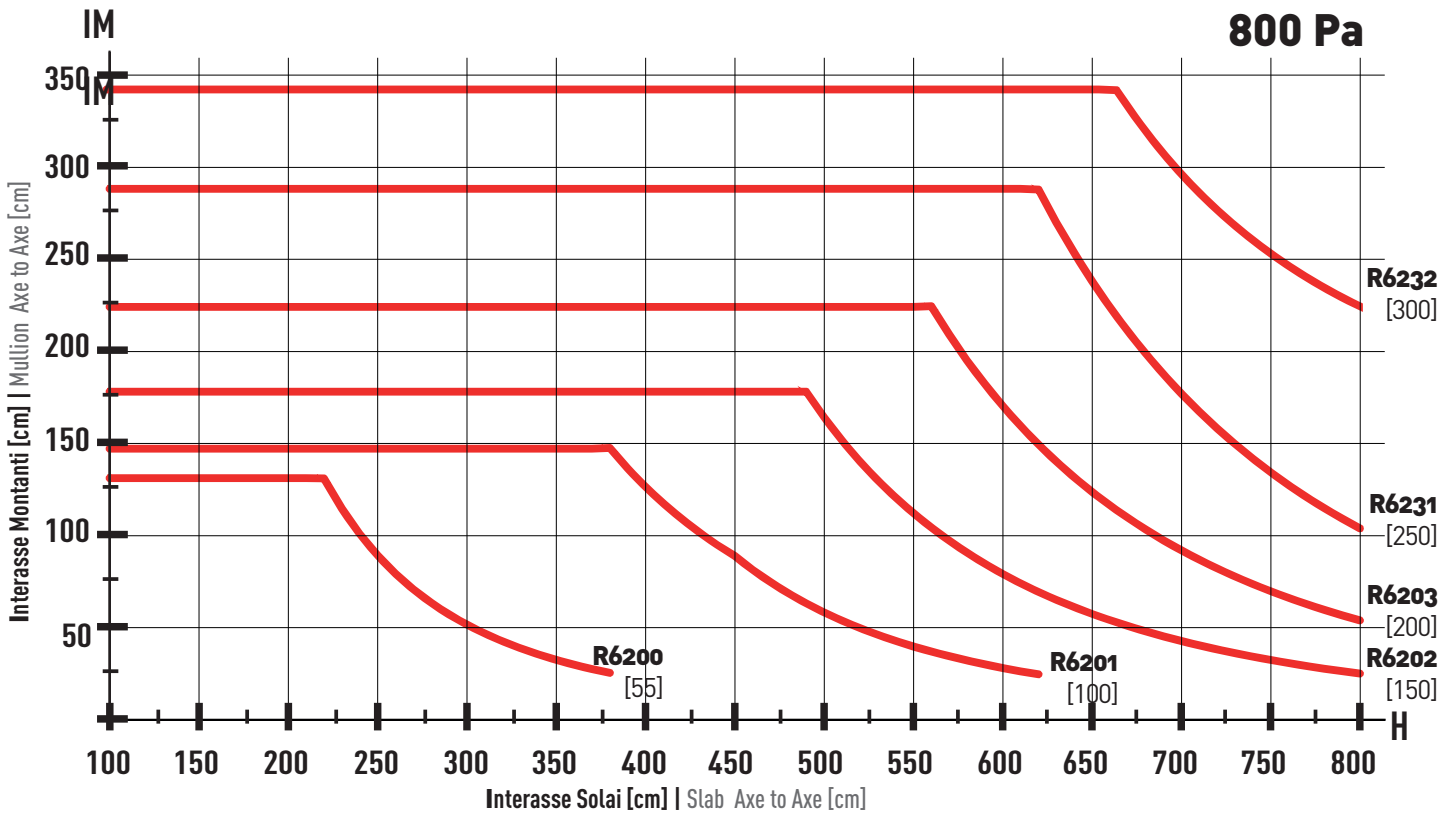
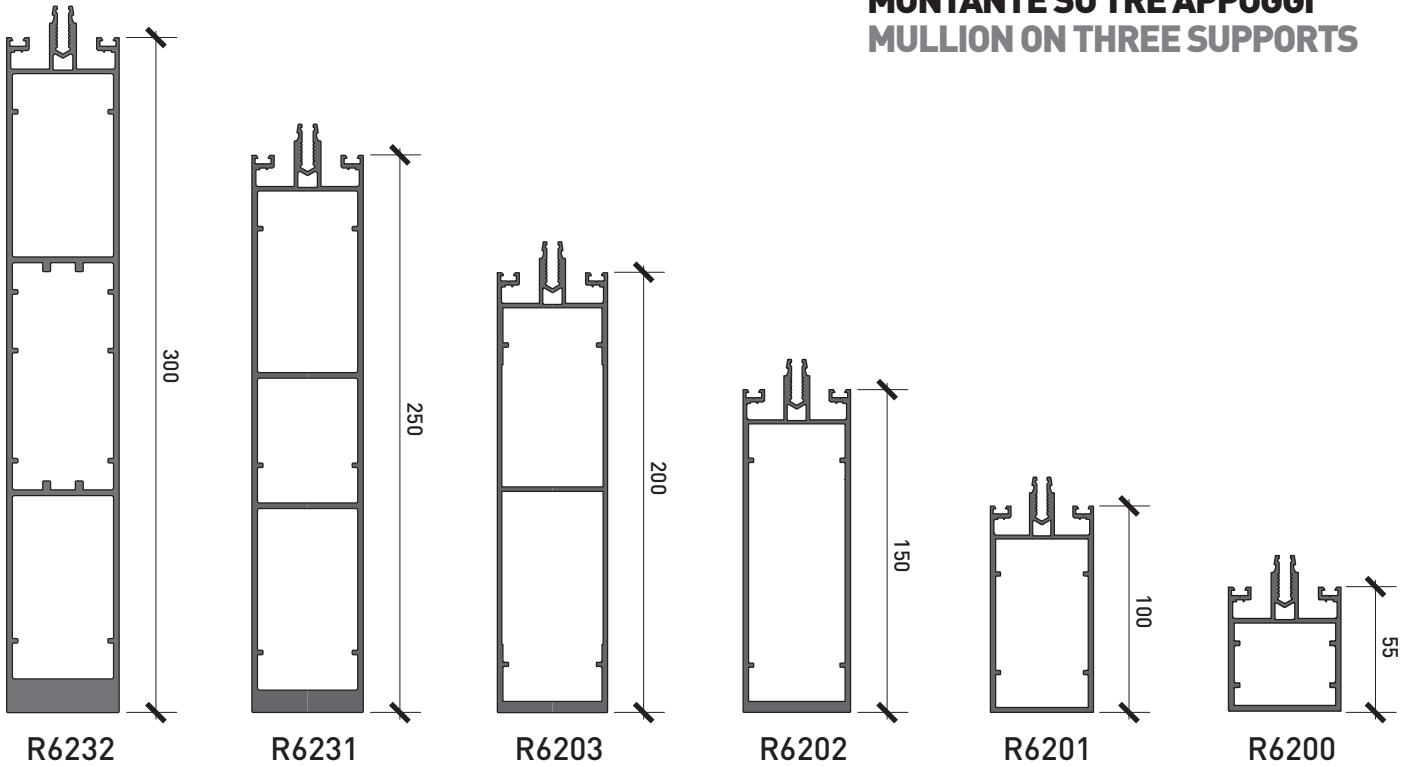

NB: Le tabelle qui riportate sono indicative, per uno studio esatto far riferimento ad un calcolo statico.
In fase esecutiva i calcoli statici vanno verificati ed approvati da un tecnico abilitato.
NB: The tables here are indicative, for one exact study to refer to a static calculation.
In the execution phase the static calculations must be verified and approved by a qualified technician.



TRAVERSO SU DUE APPOGGI
VERIFICA DEL MONTANTE AI CARICHI DI
VENTO.

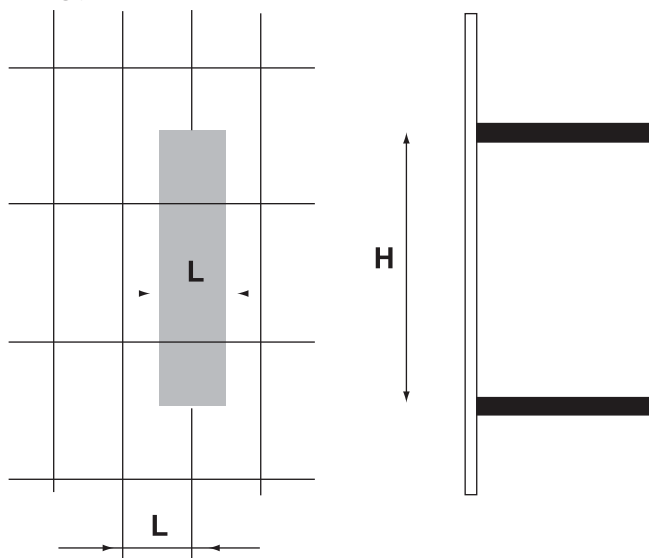

BEAM ON TWOSUPPORTS
MULLION VERIFI CATION ON WIND LOADS.

$$f_{\max} = \frac{5}{384} \cdot \frac{qLH^4}{EJ} \leq f_{\text{amm}}$$

$$s_{\max} = \frac{1}{8} \cdot \frac{qLH^2}{W} \leq s_{\text{amm}}$$

Calcolo della freccia max e della sigma max con trave su due appoggi.

Calculation of max de fleccion and max sigma with the beam on two support.

SIMBOLOGIA / SYMBOLS

H	Interasse solaio /Floor centre line	cm
L	Interasse montanti /Mullion centre distances	cm
q	Pressione cinetica del vento /Wind kinetic pressure	Kg/cm ²
E	Modulo di elasticità /Moduls of elasticity	Kg/cm ² 700000 per l'alluminio Kg/cm ² 700000 for aluminium
J	Momento d'inerzia /Moment of inertia	cm ⁴
W	Modulo di resistenza minimo /Minimum section modulus	cm ³
f_{max}	Freccia massima /Maximum de flection	cm
s_{max}	Tensione normale massima /Maximum normal tension	Kg/cm ²
f_{amm}	Freccia ammissibile /Allowed de flection	cm
s_{amm}	Tensione normale ammissibile /Normal allowed tension	Kg/cm ²

LIMITI DI IMPIEGO. TRAVERSO SU DUE
APPOGGI.

Il dimensionamento risultante dal grafico è solo indicativo. Il progettista o il serramentista, nel determinare le dimensioni massime della facciata, dovrà considerare e valutare, oltre le dimensioni ed il momento d'inerzia dei profilati, anche le caratteristiche applicative e metereologiche quali l'altezza dal suolo, l'esposizione alla pioggia e la velocità dei venti nella zona.

Per questi dati consigliamo di consultare e seguire le "Raccomandazioni UNCSAAL" elaborate sulla base delle norme UNI, UNI-EN e UNI-CNR esistenti in merito. Verificare che la freccia del profilato sia compatibile con quella del vetro utilizzato.

Le curve rappresentano l'interasse tra i montanti in funzione della distanza fra i solai.

Le curve sono calcolate sulla base della deformazione elastica di L/200 o di 15mm. del serramento.

LIMITS OF USE. BEAM ON TWO SUPPORTS.

In determining the maximum dimensions of the facade, in addition to the dimensions and moment of inertia of the profiles, the designer or manufacturer must also consider and evaluate the application and meteorological conditions such as the height from the ground, exposure to rain and the speed of the winds in the area.

For these data, we recommend consulting and following the For these data, we recommend the "UNCSAAL Recommendations" drawn up on the basis of the relative UNI, UNI-EN and UNI-CNR standards. Check that the arrow on the profile is compatible with the arrow on the glass used.

The curves represent the distance between the uprights as a function of the distance between the floors.

The curves are calculated on the basis of the elastic deformation of L/200 or 15mm. of the window.



MONTANTE SU DUE APPOGGI
MULLION ON TWO SUPPORTS

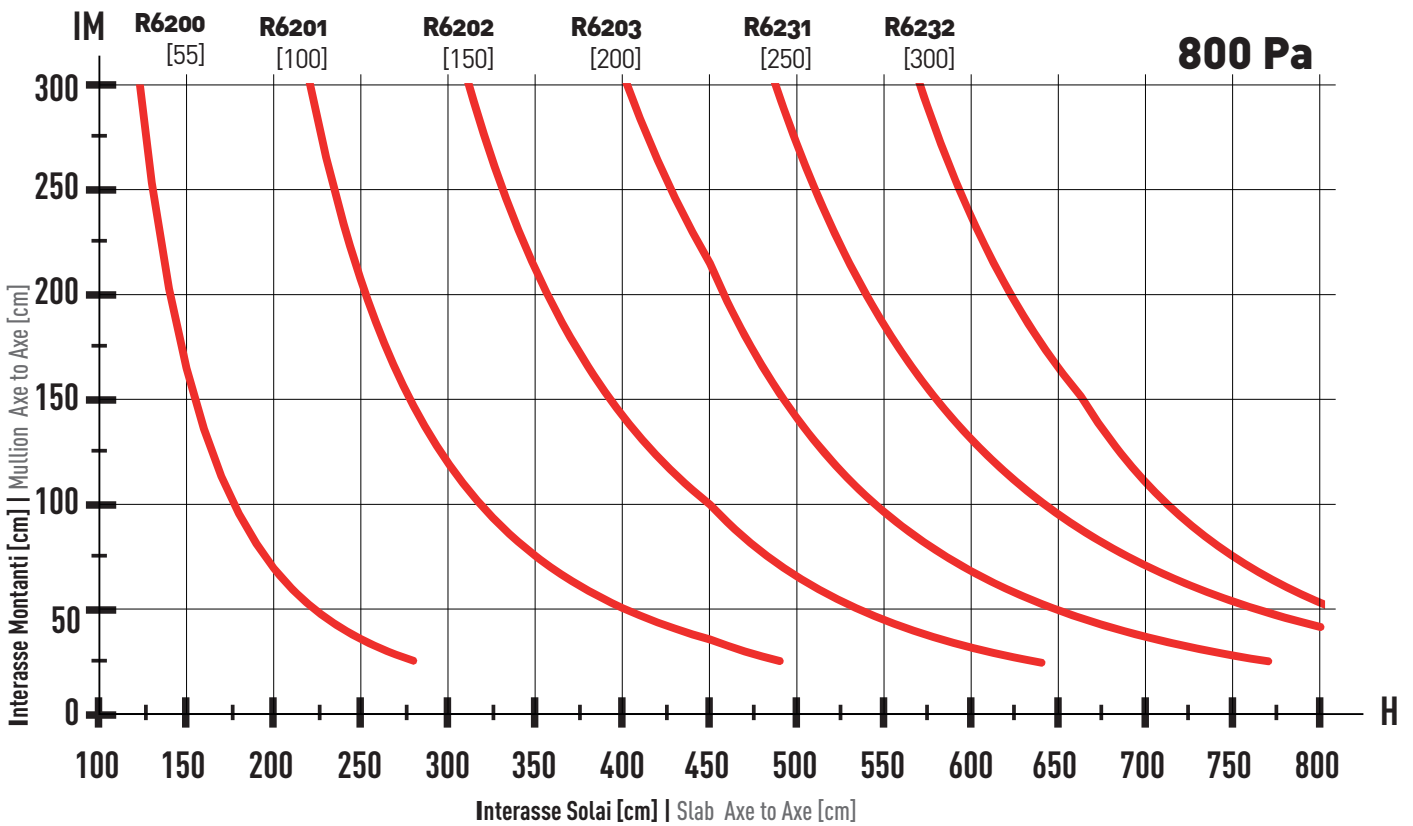
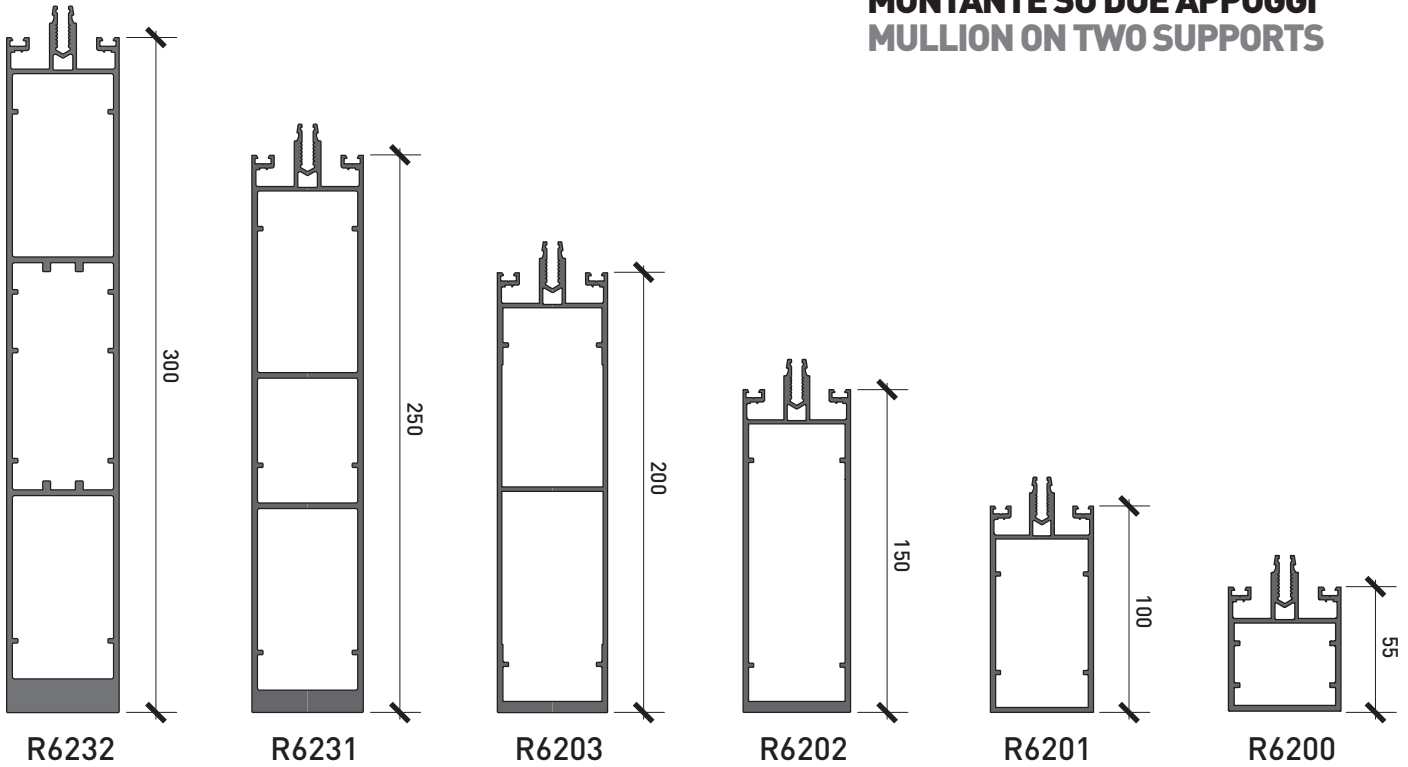

NB: Le tabelle qui riportate sono indicative, per uno studio esatto far riferimento ad un calcolo statico.
In fase esecutiva i calcoli statici vanno verificati ed approvati da un tecnico abilitato.

NB: The tables here are indicative, for one exact study to refer to a static calculation.
In the execution phase the static calculations must be verified and approved by a qualified technician.

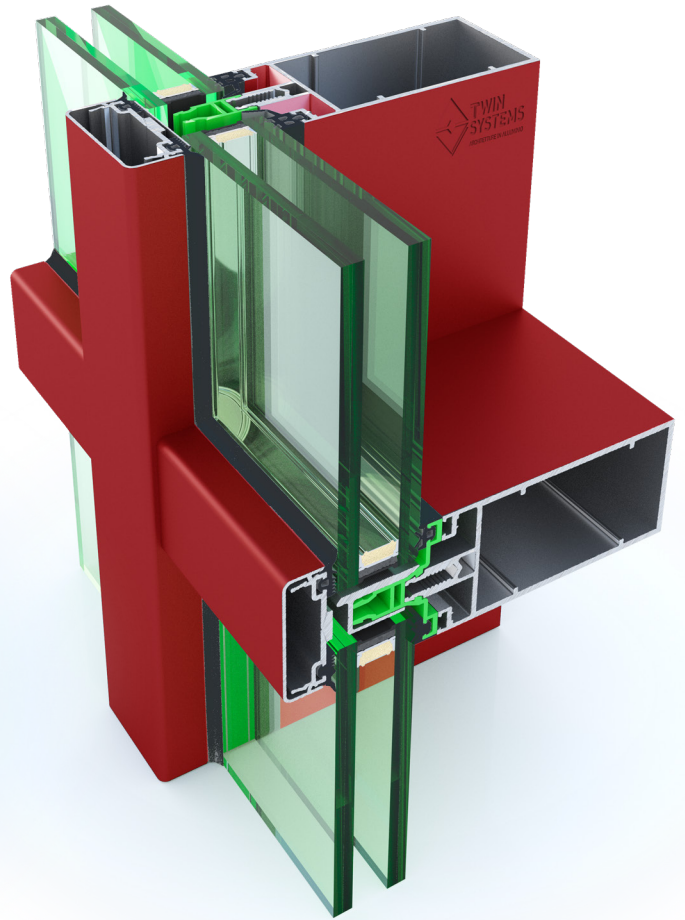
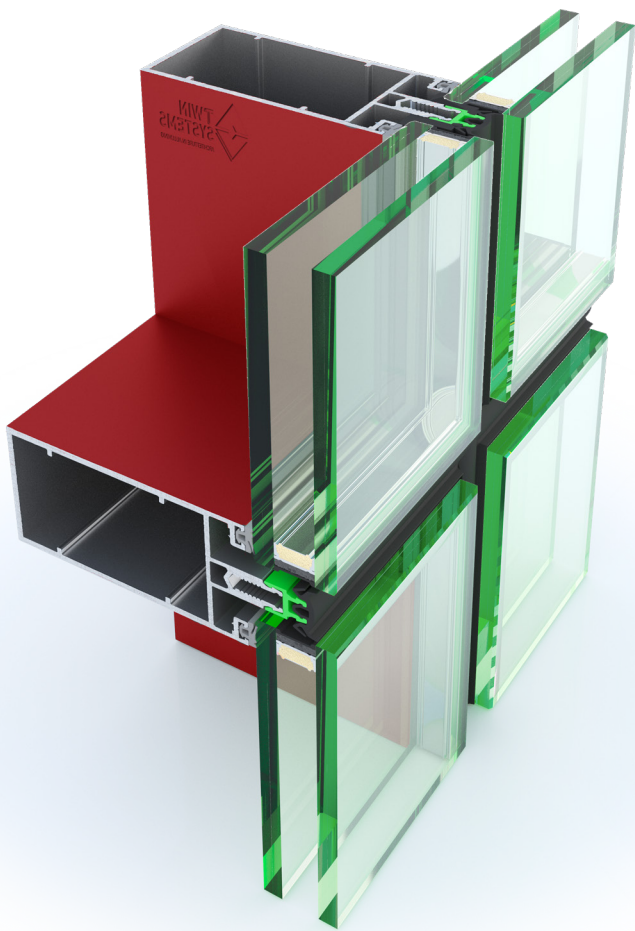

Evolution **GLASS**

Evolution

Profili
Profiles

Gruppo B

Elenco Profili
Profili Scala 1:1

Profiles List
Profiles Scale 1:1



R6200		Tavola Table 10
Montante/Traverso 55 mm. <i>Upright/Transom 55 mm.</i>		
Peso Weight	kg/ml 1.752	
J _x 28.5 cm ⁴	W _x 7.61 cm ³	
J _y 20.72 cm ⁴	W _y 8.29 cm ³	

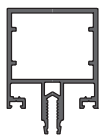

R6201		Tavola Table 05
Montante/Traverso 100 mm. <i>Upright/Transom 100 mm.</i>		
Peso Weight	kg/ml 2.415	
J _x 118.73 cm ⁴	W _x 20.73 cm ³	
J _y 31.89 cm ⁴	W _y 12.75 cm ³	

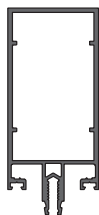

R6202		Tavola Table 06
Montante/Traverso 150 mm. <i>Upright/Transom 150 mm.</i>		
Peso Weight	kg/ml 3.4	
J _x 387.89 cm ⁴	W _x 44.54 cm ³	
J _y 45.45 cm ⁴	W _y 18.18 cm ³	

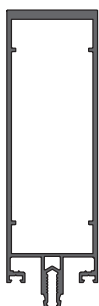

R6203		Tavola Table 07
Montante/Traverso 200 mm. <i>Upright/Transom 200 mm.</i>		
Peso Weight	kg/ml 3.977	
J _x 775.97 cm ⁴	W _x 69.56 cm ³	
J _y 58.6 cm ⁴	W _y 23.44 cm ³	



R6220		Tavola Table 05
Profilo canotto e rinforzo montanti <i>Sleeve profile and upright reinforcement</i>		
Peso Weight	kg/ml 2.626	
J _x 88.07 cm ⁴	W _x 20.58 cm ³	
J _y 19.27 cm ⁴	W _y 8.76 cm ³	

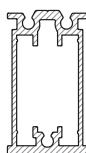

R6231		Tavola Table 08
Montante/Traverso 250 mm. <i>Upright/Transom 250 mm.</i>		
Peso Weight	kg/ml 5.977	
J _x 1691 cm ⁴	W _x 112.9 cm ³	
J _y 85.75 cm ⁴	W _y 34.3 cm ³	



R6232		Tavola Table 09
Montante da 300 mm. <i>300 mm mast.</i>		
Peso Weight	kg/ml 7.484	
J _x 3034,00 cm ⁴	W _x 164,03 cm ³	
J _y 104,98 cm ⁴	W _y 42,00 cm ³	



R6221		Tavola Table 10
Montante per soluzioni angolari Max 30° <i>Upright for corner solutions Max 30°</i>		
Peso Weight	kg/ml 3.754	
J _x 350.51 cm ⁴	W _x 39.32 cm ³	
J _y 38.32 cm ⁴	W _y 15.33 cm ³	

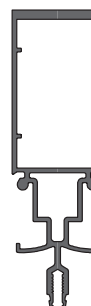

R6236		Tavola Table 13
Supporto Vetro con BX24. Vetr. 31-48 <i>Glass Holder with BX24. Glazings 31-48</i>		
Peso Weight	kg/ml 0,534	
J _x 0 cm ⁴	W _x 0 cm ³	
J _y 0 cm ⁴	W _y 0 cm ³	





R6219				Tavola Table 12
Mont./Trav. per app. partic. e cop. <i>Mullion/Transom for special apps and roofing</i>				
Peso Weight		kg/ml	0.927	
J _x	0	cm ⁴	W _x 0 cm ³	
J _y	0	cm ⁴	W _y 0 cm ³	



R6223				Tavola Table 14
Pressore mont. sol. ang. 18°/30° <i>Mullion presser ang. sol. 18°/30°</i>				
Peso Weight		kg/ml	0.93	
J _x	0	cm ⁴	W _x 0 cm ³	
J _y	0	cm ⁴	W _y 0 cm ³	



R6204				Tavola Table 13
Carter EXT semi-ovale <i>EXT Semi-oval Cover</i>				
Peso Weight		kg/ml	1.085	
J _x	27.31	cm ⁴	W _x 6.2 cm ³	
J _y	12.68	cm ⁴	W _y 4.92 cm ³	

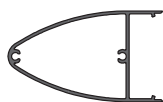

R6208				Tavola Table 12
Anta sporgere <i>Sash protrude</i>				
Peso Weight		kg/ml	1.107	
J _x	15.3	cm ⁴	W _x 4.69 cm ³	
J _y	7.18	cm ⁴	W _y 2.93 cm ³	



R5617				Tavola Table 04
Carter EXT H=15 mm. <i>EXT cover H=15 mm.</i>				
Peso Weight		kg/ml	0.26	
J _x	0	cm ⁴	W _x 0 cm ³	
J _y	0	cm ⁴	W _y 0 cm ³	



R6222				Tavola Table 10
Anta montante per sol. ang. Max 30° <i>Mullion Sash for corner sol. Max 30°</i>				
Peso Weight		kg/ml	0.788	
J _x	0	cm ⁴	W _x 0 cm ³	
J _y	0	cm ⁴	W _y 0 cm ³	



R3994				Tavola Table 04
Carter EXT H=20 mm. <i>EXT cover H=20 mm.</i>				
Peso Weight		kg/ml	0.29	
J _x	0	cm ⁴	W _x 0 cm ³	
J _y	0	cm ⁴	W _y 0 cm ³	



R4263				Tavola Table 10
Profilo Interno <i>Int. Profile</i>				
Peso Weight		kg/ml	0.654	
J _x	0	cm ⁴	W _x 0 cm ³	
J _y	0	cm ⁴	W _y 0 cm ³	



R3995				Tavola Table 04
Carter trasversi H=15 mm. <i>Transom Carter H=15 mm.</i>				
Peso Weight		kg/ml	0.295	
J _x	0	cm ⁴	W _x 0 cm ³	
J _y	0	cm ⁴	W _y 0 cm ³	



R6211				Tavola Table 11
Profilo compensazione laterale <i>Lateral compensation profile</i>				
Peso Weight		kg/ml	0.55	
J _x	0	cm ⁴	W _x 0 cm ³	
J _y	0	cm ⁴	W _y 0 cm ³	



R6224				Tavola Table 14
Carter mont. per sol. ang. da 18° a 30° <i>Riser cover for corner sol. from 18° to 30°</i>				
Peso Weight		kg/ml	0.62	
J _x	0	cm ⁴	W _x 0 cm ³	
J _y	0	cm ⁴	W _y 0 cm ³	



R6212				Tavola Table 11
Prof. finit. lat. e alloggio cartongesso inf. <i>Side fin. prof. and lower plasterboard hous.</i>				
Peso Weight		kg/ml	0.861	
J _x	0	cm ⁴	W _x 0 cm ³	
J _y	0	cm ⁴	W _y 0 cm ³	

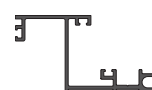

R6207				Tavola Table 12
Telaio per apertura EXT <i>EXT opening frame</i>				
Peso Weight		kg/ml	1.185	
J _x	21.12	cm ⁴	W _x 5.28 cm ³	
J _y	13.08	cm ⁴	W _y 2.87 cm ³	

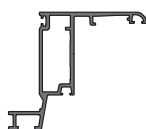

R6213				Tavola Table 11
Profilo a scatto per R6212 <i>Snap profile for R6212</i>				
Peso Weight		kg/ml	0.421	
J _x	0	cm ⁴	W _x 0 cm ³	
J _y	0	cm ⁴	W _y 0 cm ³	



R3996				Tavola Table 04
Pressore <i>Presser</i>				
Peso Weight		kg/ml	0.439	
J _x	0	cm ⁴	W _x 0 cm ³	
J _y	0	cm ⁴	W _y 0 cm ³	



R6214				Tavola Table 11
Profilo sostegno EVOLUTION <i>EVOLUTION support profile</i>				
Peso Weight		kg/ml	0.611	
J _x	0	cm ⁴	W _x 0 cm ³	
J _y	0	cm ⁴	W _y 0 cm ³	





R6216			
Prof. cartongesso superiore <i>Upper plasterboard profile</i>			
Peso Weight		kg/ml	0.643
J _x	0	cm ²	W _x 0 cm ³
J _y	0	cm ²	W _y 0 cm ³



Tavola
Table
11

RE6230			
Dist. lat. da 14 mm. per riduzione vetro <i>14 mm. side spacer for glass reduction</i>			
Peso Weight		kg/ml	0.157
J _x	0	cm ²	W _x 0 cm ³
J _y	0	cm ²	W _y 0 cm ³



Tavola
Table
13

R6217			
Profilo coperture Ext. <i>Ext. roofing profile</i>			
Peso Weight		kg/ml	0.566
J _x	0	cm ²	W _x 0 cm ³
J _y	0	cm ²	W _y 0 cm ³



Tavola
Table
12

R6234			
XXXX per Angolo 90° <i>XXXX for 90° angle</i>			
Peso Weight		kg/ml	0.525
J _x	0	cm ²	W _x 0 cm ³
J _y	0	cm ²	W _y 0 cm ³



Tavola
Table
13

R6226			
Profilo sostegno vetro EVOLUTION GLASS <i>EVOLUTION GLASS glass support profile</i>			
Peso Weight		kg/ml	0.563
J _x	0	cm ²	W _x 0 cm ³
J _y	0	cm ²	W _y 0 cm ³



Tavola
Table
11

80x80x8			
Angolare per staffaggio nascosto <i>Angle for hidden bracketing</i>			
Peso Weight		kg/ml	3.283
J _x	0	cm ²	W _x 0 cm ³
J _y	0	cm ²	W _y 0 cm ³



Tavola
Table
11

R6227			
Profilo per Angolo Variabile 60°-90° <i>Profile for Variable Angle 60°-90°</i>			
Peso Weight		kg/ml	0.992
J _x	0	cm ²	W _x 0 cm ³
J _y	0	cm ²	W _y 0 cm ³

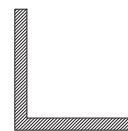

Tavola
Table
13

EWP.601			
R6205 R6206 Profilo abbin. serie <i>R6205 R6206 Series matching prof.</i>			
Peso Weight		kg/ml	0.956
J _x	0	cm ²	W _x 0 cm ³
J _y	0	cm ²	W _y 0 cm ³



Tavola
Table
12

R3998			
Profilo di Rinforzo per Angolo 90° <i>Reinforcement profile for 90° corner</i>			
Peso Weight		kg/ml	1.15
J _x	0	cm ²	W _x 0 cm ³
J _y	0	cm ²	W _y 0 cm ³



Tavola
Table
13

EWP.602			
Anta Abbaino <i>Dormer Sash</i>			
Peso Weight		kg/ml	1,424
J _x	0	cm ²	W _x 0 cm ³
J _y	0	cm ²	W _y 0 cm ³



Tavola
Table
15

R6233			
Supporto vetro maggiorato <i>Increased glass support</i>			
Peso Weight		kg/ml	0.94
J _x	0	cm ²	W _x 0 cm ³
J _y	0	cm ²	W _y 0 cm ³

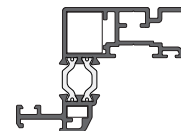

Tavola
Table
13

EWP.603			
Telaio Abbaino <i>Dormer Frame</i>			
Peso Weight		kg/ml	2,681
J _x	0	cm ²	W _x 0 cm ³
J _y	0	cm ²	W _y 0 cm ³



Tavola
Table
15

R6229			
Cartella EXT da 40 mm. <i>EXT folder mm. 40</i>			
Peso Weight		kg/ml	0.673
J _x	0	cm ²	W _x 0 cm ³
J _y	0	cm ²	W _y 0 cm ³

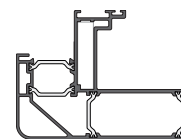

Tavola
Table
13

R6225			
Carter Abbaino <i>Dormer Carter</i>			
Peso Weight		kg/ml	1,224
J _x	0	cm ²	W _x 0 cm ³
J _y	0	cm ²	W _y 0 cm ³

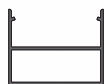

Tavola
Table
15

R6235			
Carter di Finitura per Angolo 90° <i>Finishing Carter for 90° Corner</i>			
Peso Weight		kg/ml	1.89
J _x	0	cm ²	W _x 0 cm ³
J _y	0	cm ²	W _y 0 cm ³



Tavola
Table
14

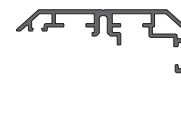
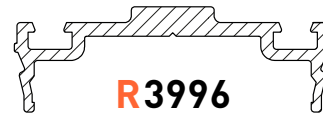
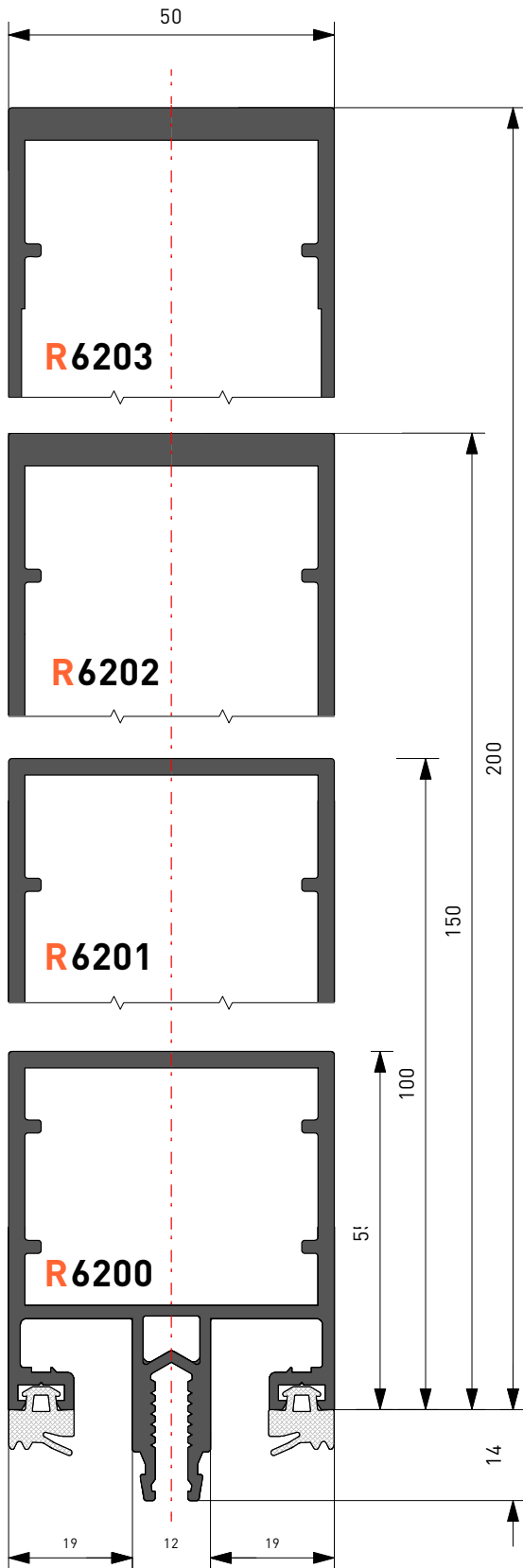

R3996

Peso 0.439 kg./ml.



R5617

Peso 0.260 kg./ml.



R3994

Peso 0.290 kg./ml.

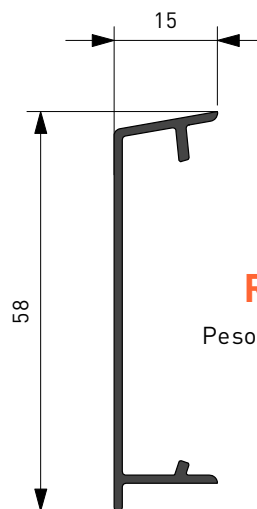

R3995

Peso 0.295 kg./ml.



VALORI INERZIA
Inertia Values

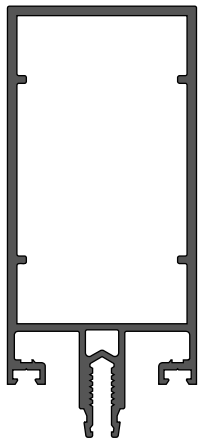

Ixx: 119,68 cm⁴
Iyy: 33,44 cm⁴
Sxx: 36,55 cm³
Syy: 19,32 cm³

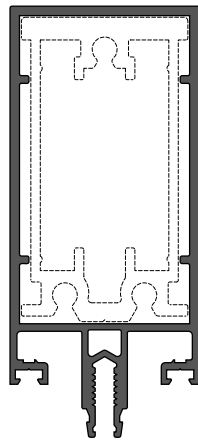

Ixx: 221,51 cm⁴
Iyy: 53,16 cm⁴
Sxx: 34,32 cm³
Syy: 16,81 cm³

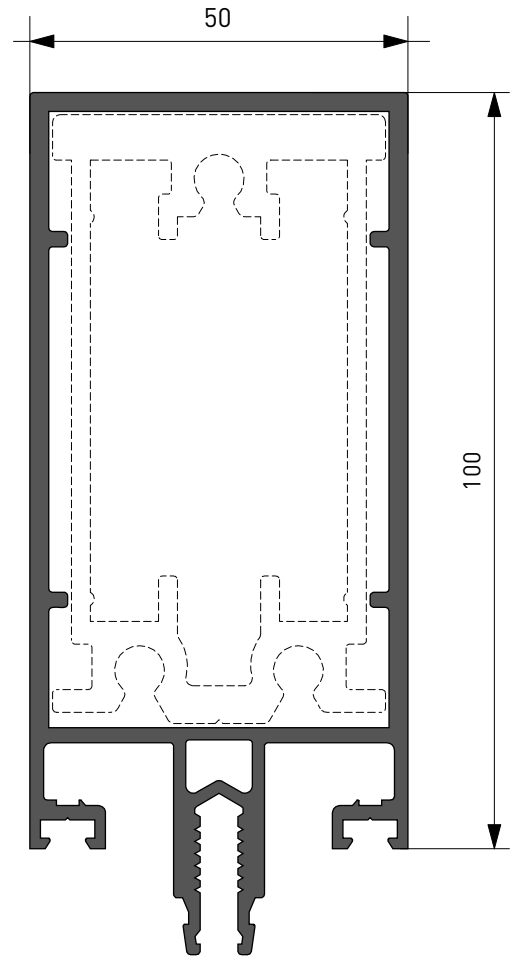

R 6201

Peso 2.415 Kq/ml
L.= 250 mm.

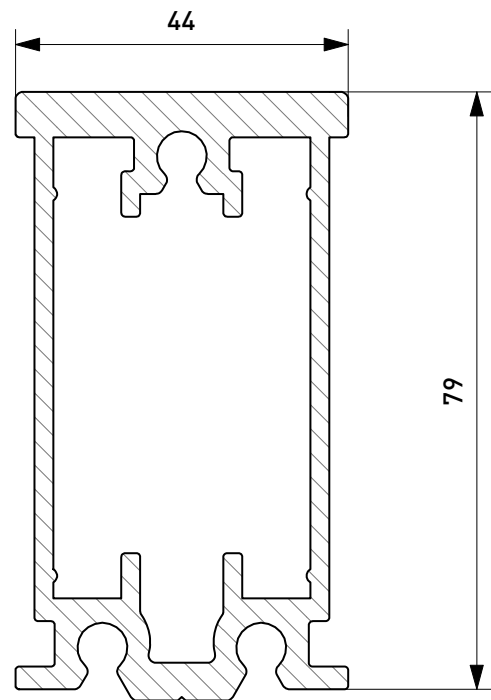

R 6220

Peso 2.626 Kq/ml



VALORI INERZIA
Inertia Values

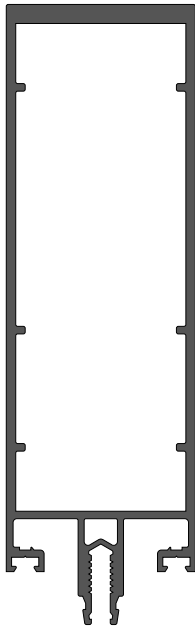

Ixx: 392,69 cm⁴
Iyy: 49,45 cm⁴

Sxx: 55,86 cm³
Syy: 19,82 cm³

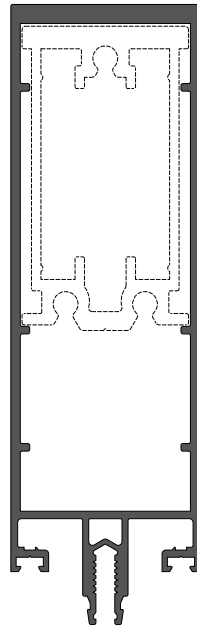

Ixx: 544,24 cm⁴
Iyy: 69,20 cm⁴

Sxx: 49,25 cm³
Syy: 18,13 cm³

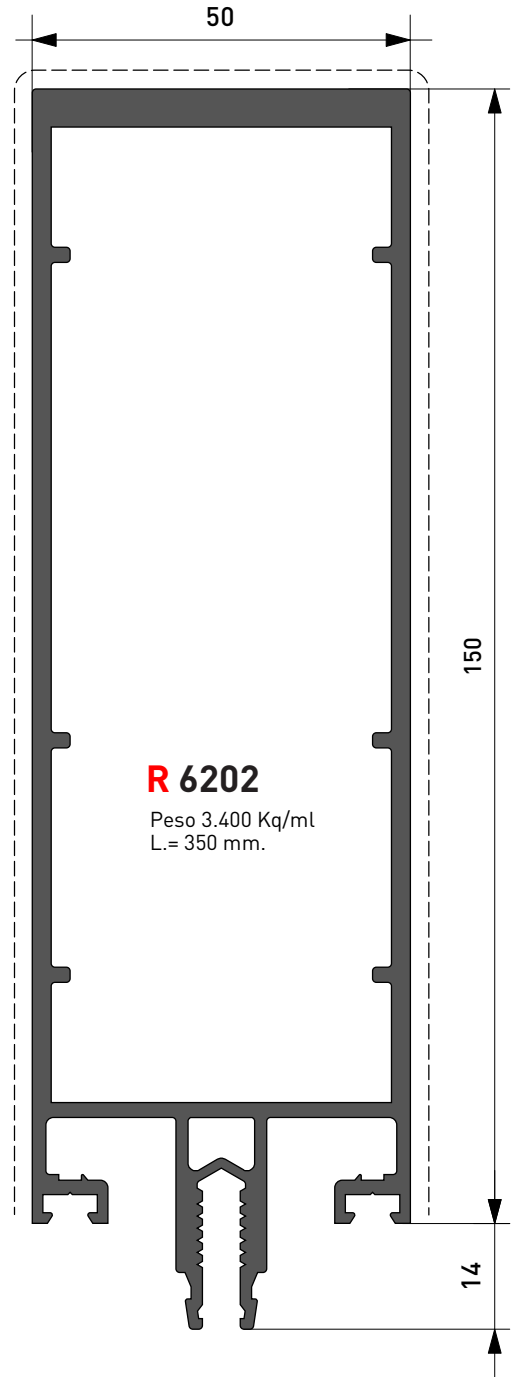



VALORI INERZIA
Inertia Values

<p>Ixx: 794,12 cm⁴ Iyy: 65,12 cm⁴</p> <p>Sxx: 70,48 cm³ Syy: 20,19 cm³</p>	<p>Ixx: 108,65 cm⁴ Iyy: 84,87 cm⁴</p> <p>Sxx: 64,86 cm³ Syy: 18,13 cm³</p>	<p>Ixx: 144,36 cm⁴ Iyy: 10,46 cm⁴</p> <p>Sxx: 63,62 cm³ Syy: 17,13 cm³</p>
--	--	--

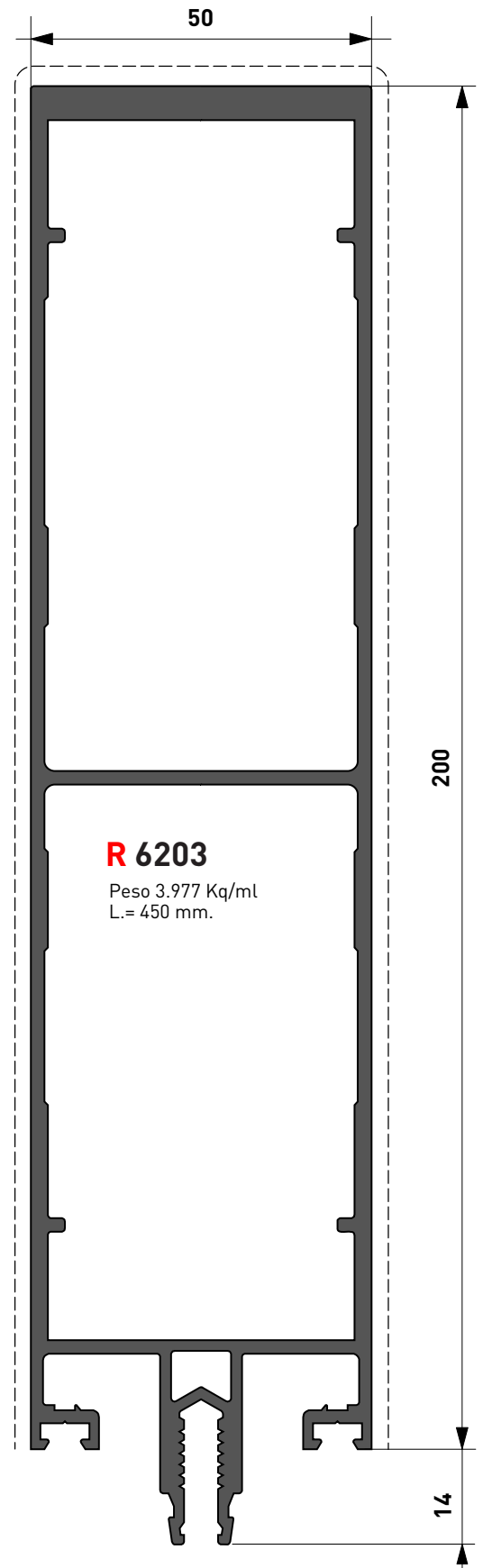



VALORI INERZIA
Inertia Values

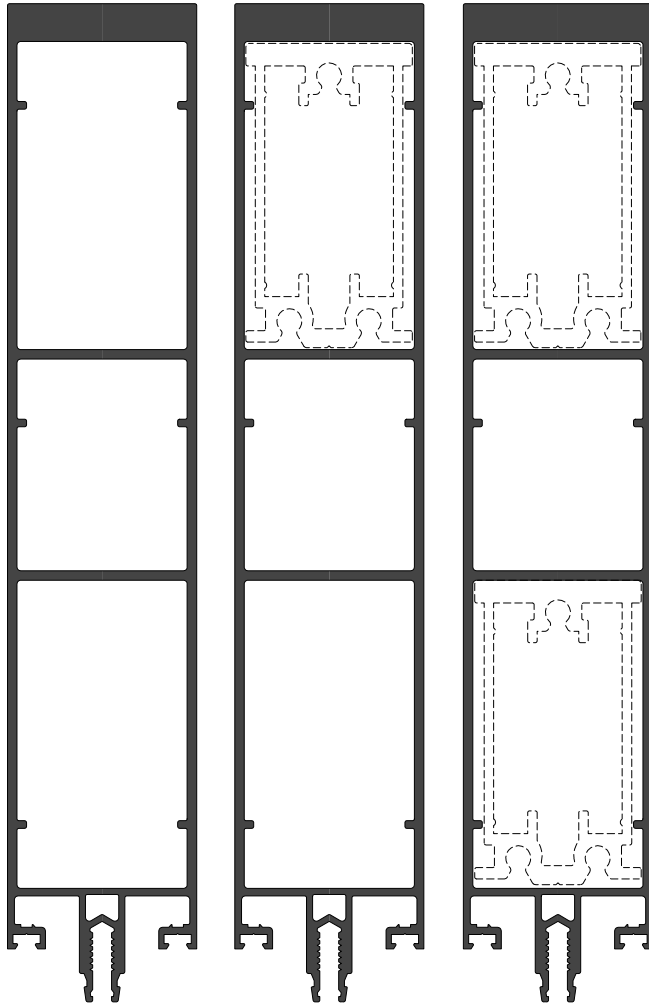

Ixx: 169,26 cm⁴
Iyy: 85,85 cm⁴

Ixx: 208,38 cm⁴
Iyy: 10,56 cm⁴

Ixx: 287,36 cm⁴
Iyy: 12,53 cm⁴

Sxx: 87,30 cm³
Syy: 19,66 cm³

Sxx: 80,62 cm³
Syy: 18,15 cm³

Sxx: 82,81 cm³
Syy: 17,30 cm³

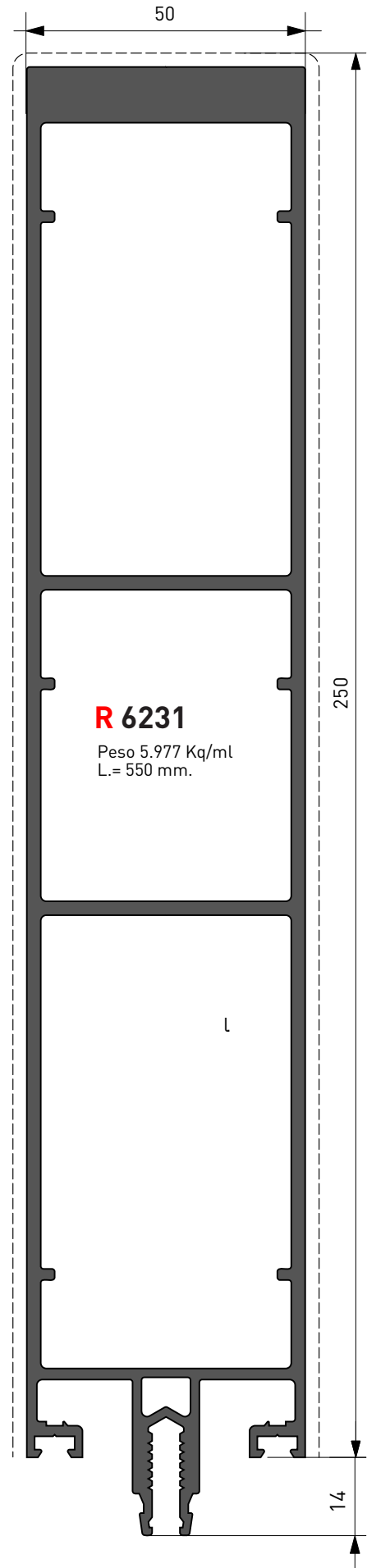

R 6231

Peso 5.977 Kg/ml
L.= 550 mm.



NB | Rappresentazione Fuori Scala
NB | Out of Scale Drawing

VALORI INERZIA
Inertia Values

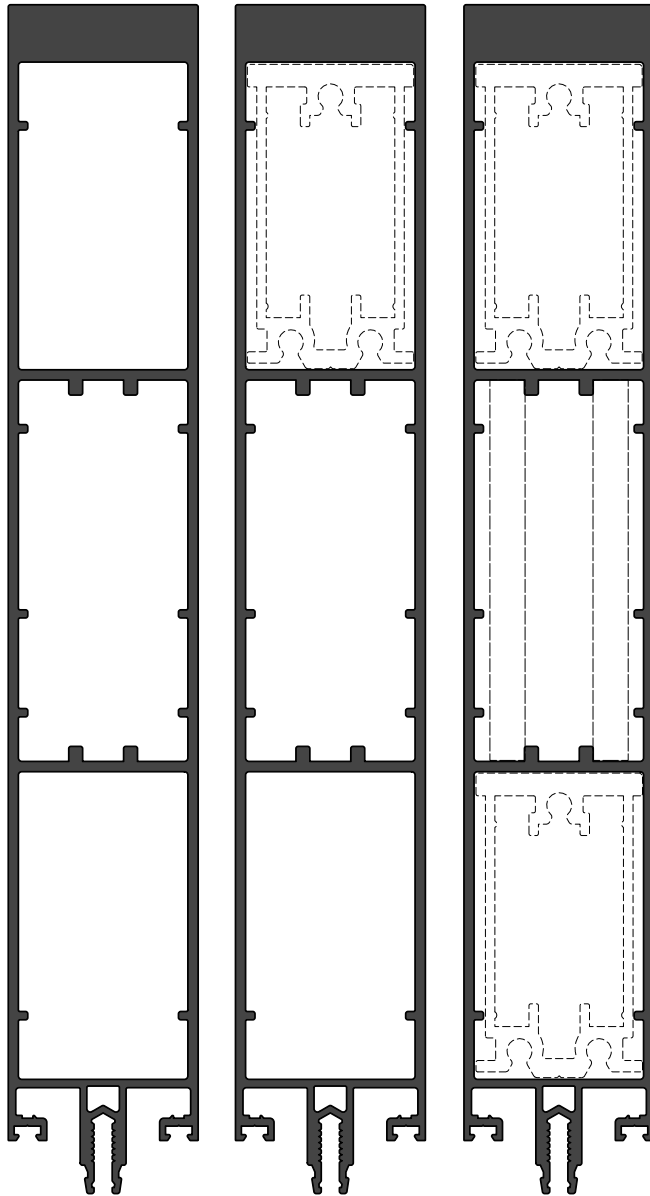

Ixx: 277,57 cm⁴
Iyy: 10,18 cm⁴

Ixx: 336,26 cm⁴
Iyy: 12,16 cm⁴

Ixx: 483,72 cm⁴
Iyy: 17,73 cm⁴

Sxx: 102,86 cm³
Syy: 19,71 cm³

Sxx: 96,54 cm³
Syy: 18,36 cm³

Sxx: 88,99 cm³
Syy: 17,04 cm³

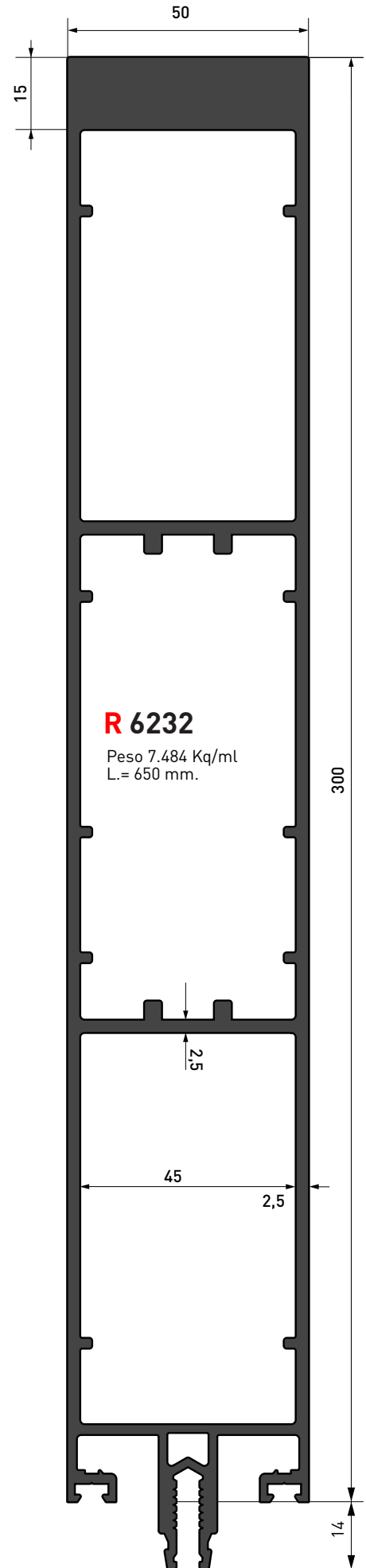

R 6232

Peso 7.484 Kq/ml
L.= 650 mm.

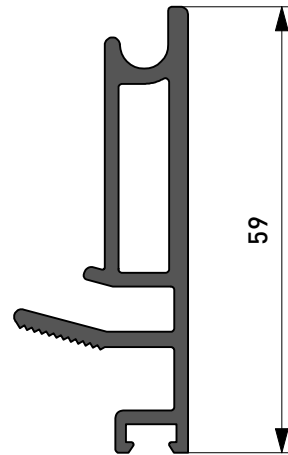
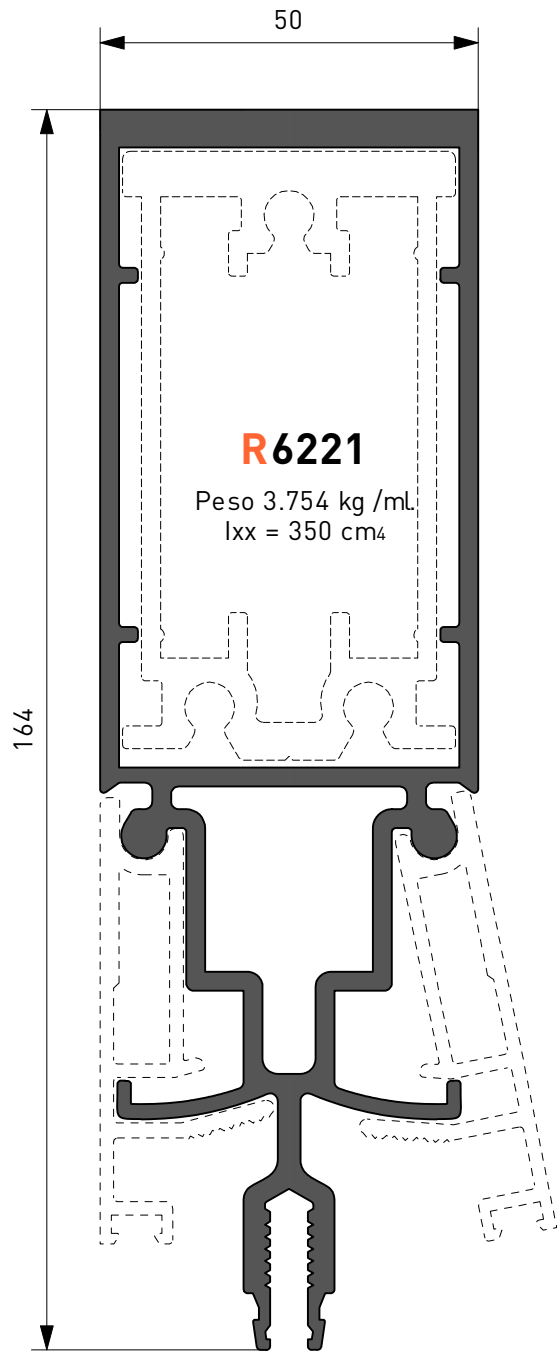

Peso 0.788 kg /ml.

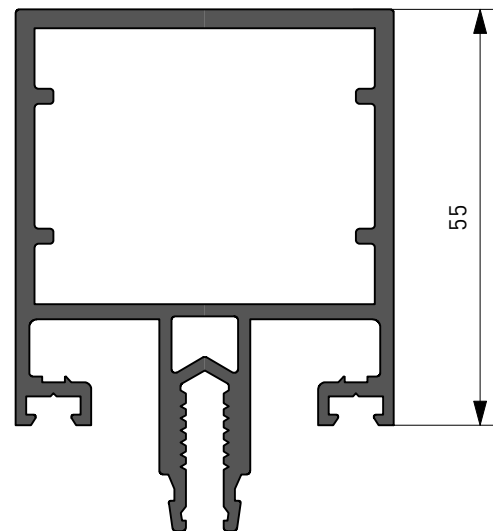

Peso 1.752 kg /ml.
Ixx = 26 cm⁴

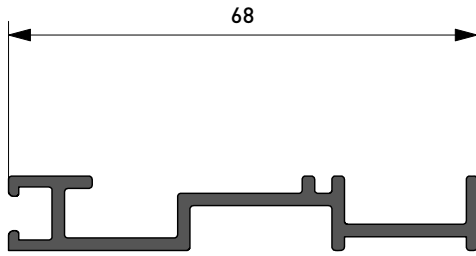

R6211

Peso 0.550 kg./ml.

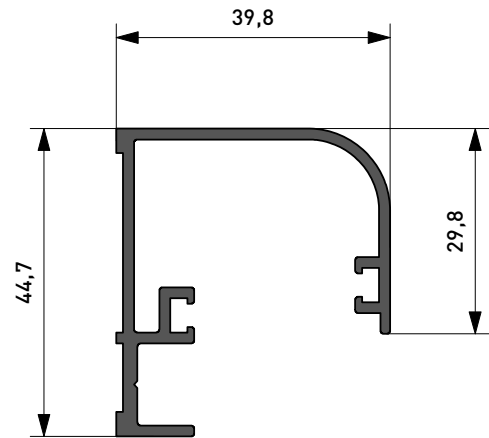

R6216

Peso 0.643 kg./ml.

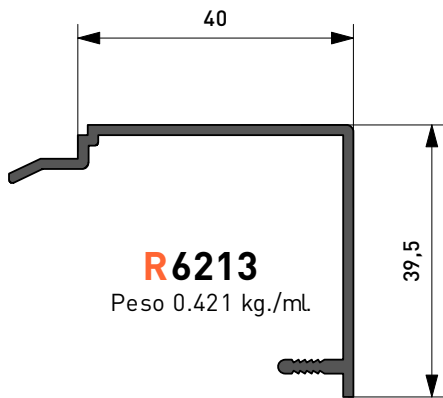

R6213

Peso 0.421 kg./ml.

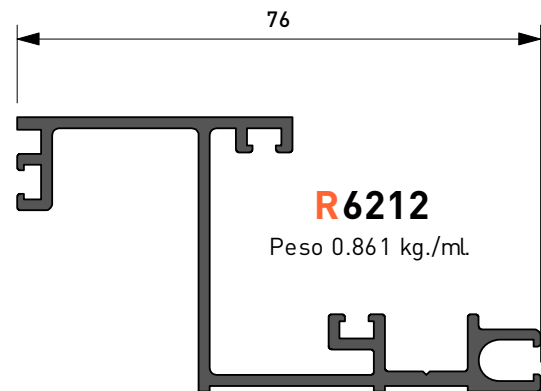

R6212

Peso 0.861 kg./ml.

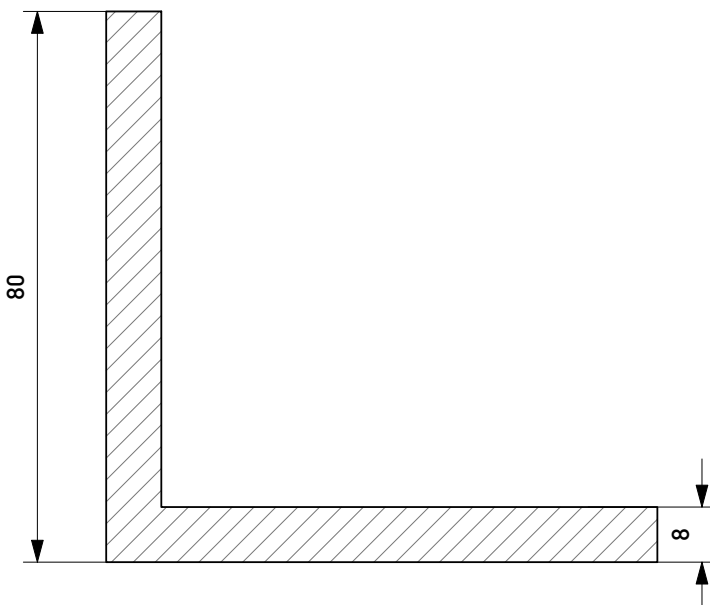

80x80x8

Peso 3.283 kg./ml.

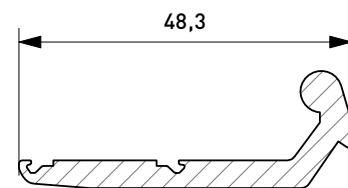

R6214

Peso 0.611 kg./ml.

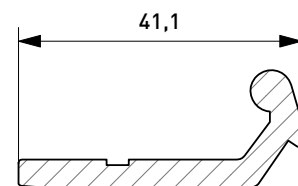

R6226

Peso 0.563 kg./ml.

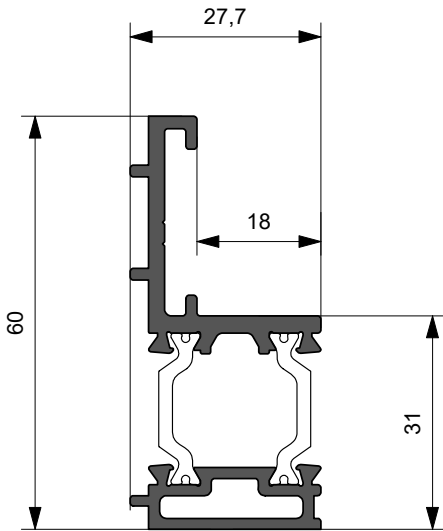

EWP.601

Peso 0.956 kg./ml.

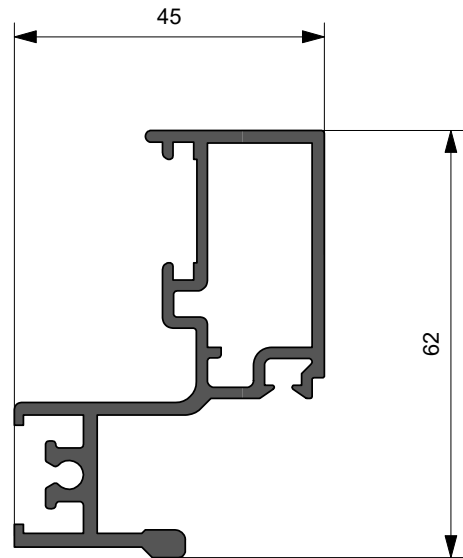

R6208

Peso 1.107 kg./ml.

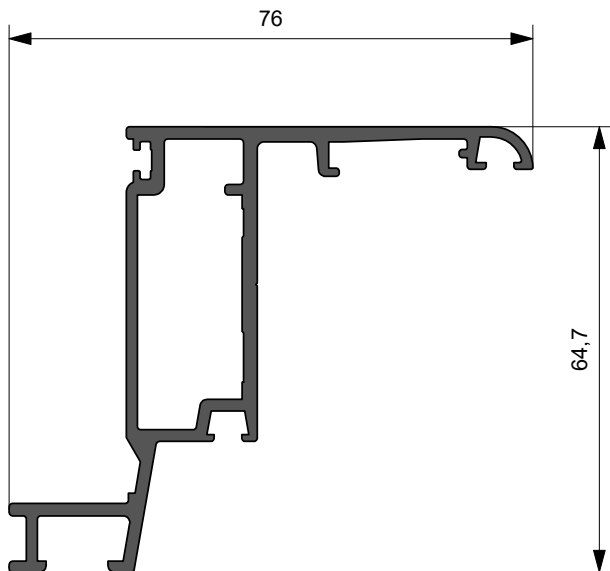

R6207

Peso 1.185 kg./ml.

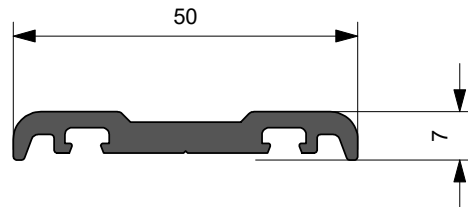

R6217

Peso 0.566 kg./ml.

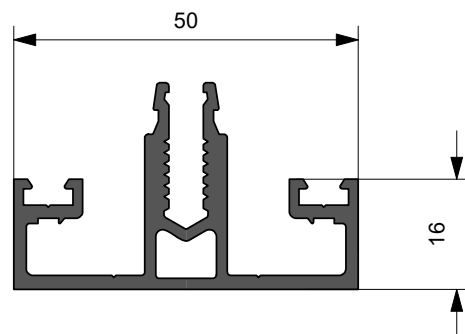

R6219

Peso 0.927 kg./ml.

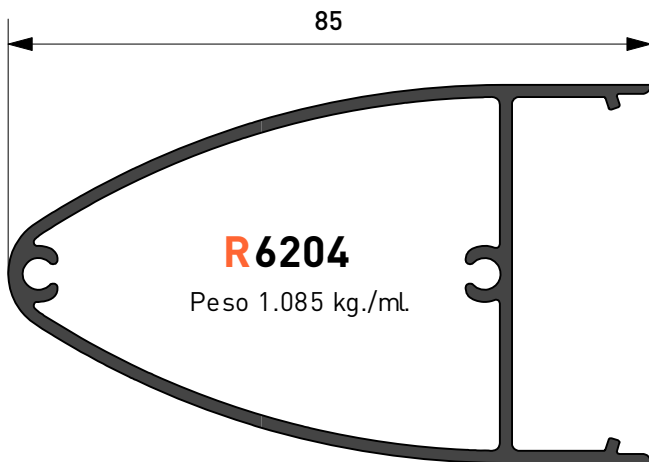
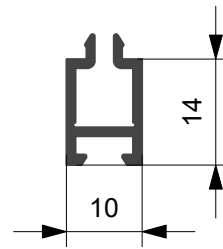
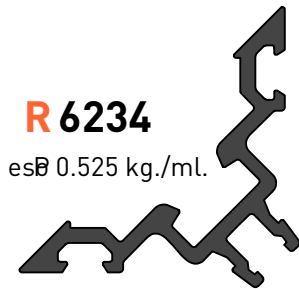
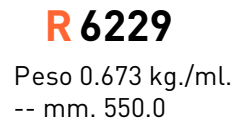
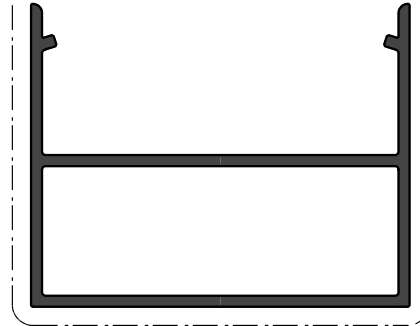
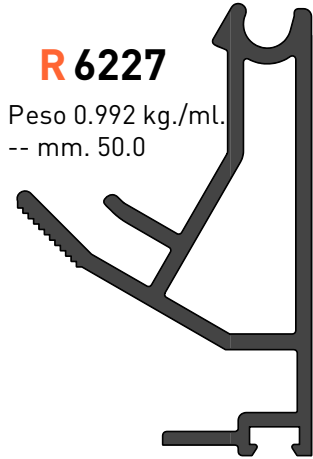

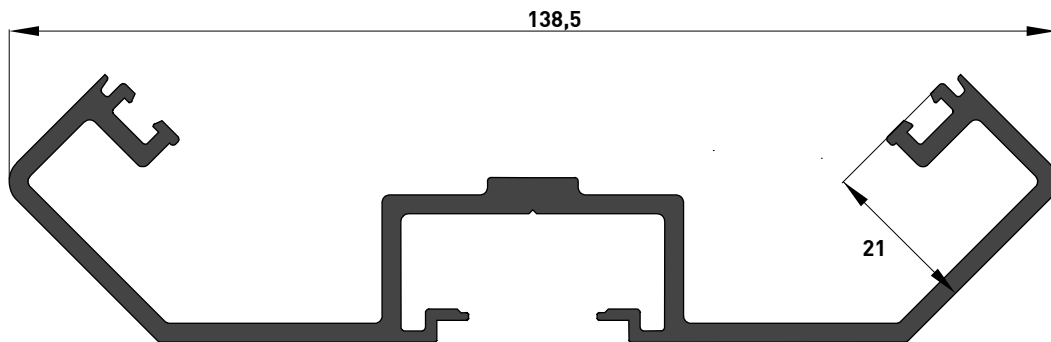
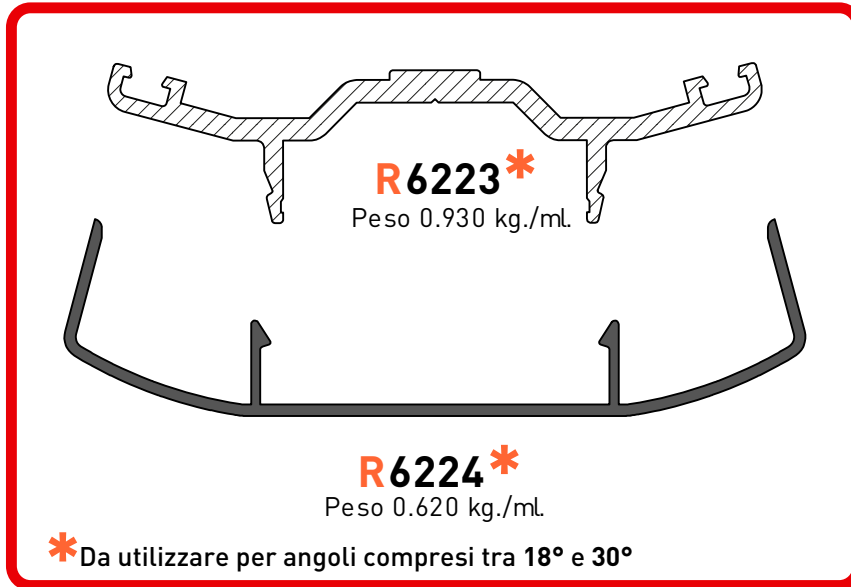

R 6235
Peso 1.890 kg/ml.

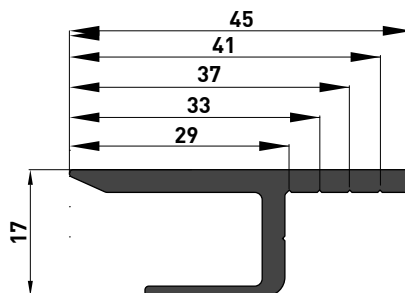

R 6236
Peso 0,534 kg/ml.

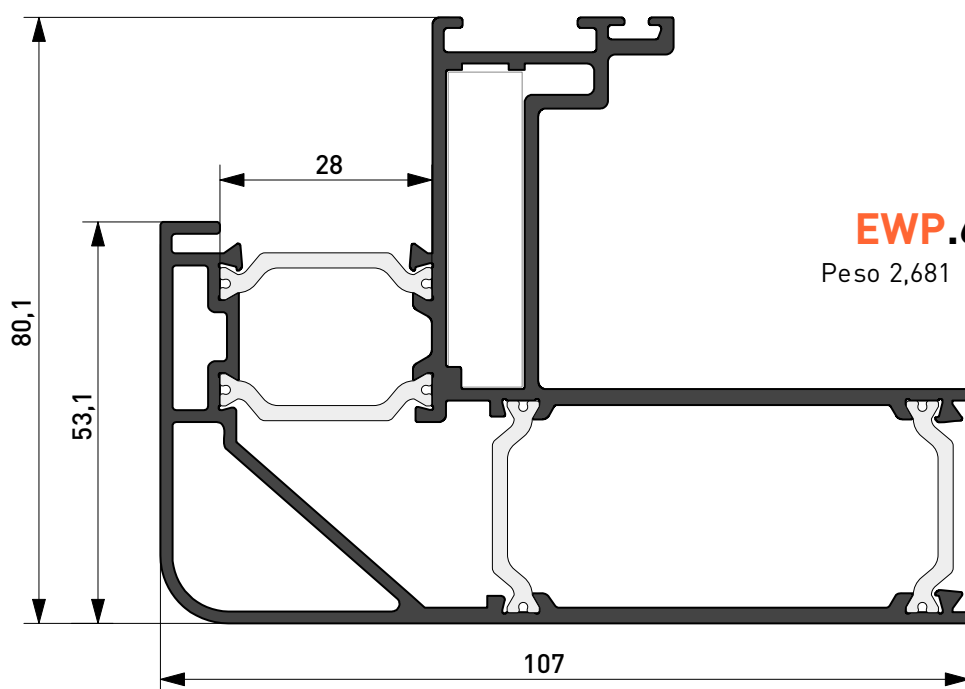
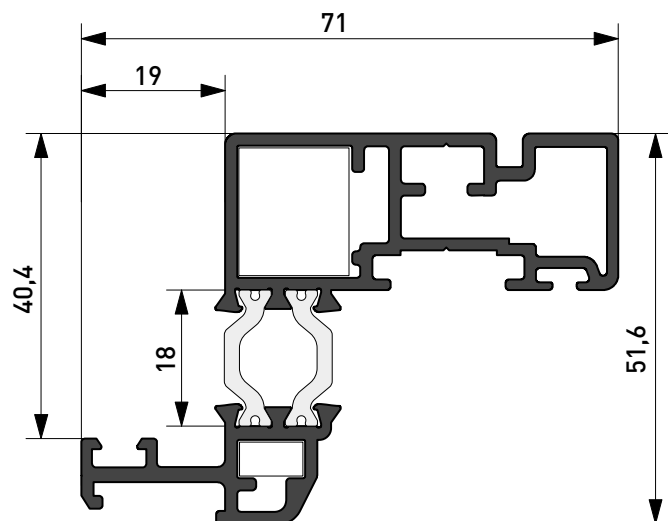
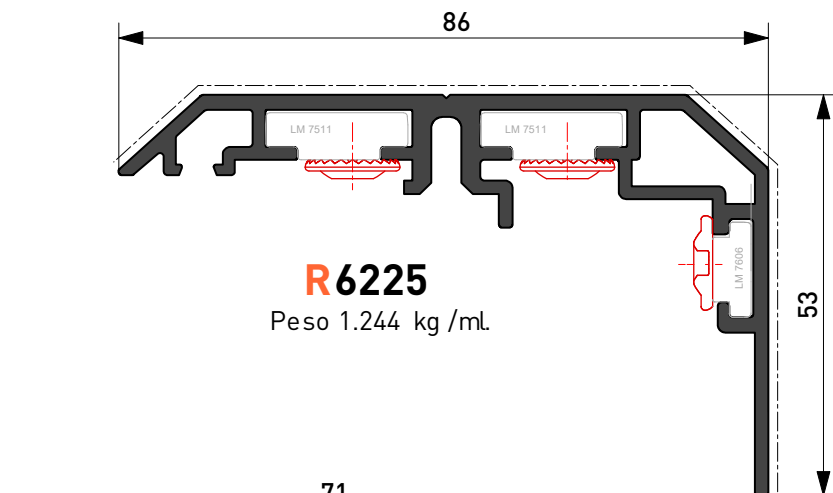



Evolution

SUPPORTO VETRO MAGGIORATO INCREASED GLASS SUPPORT

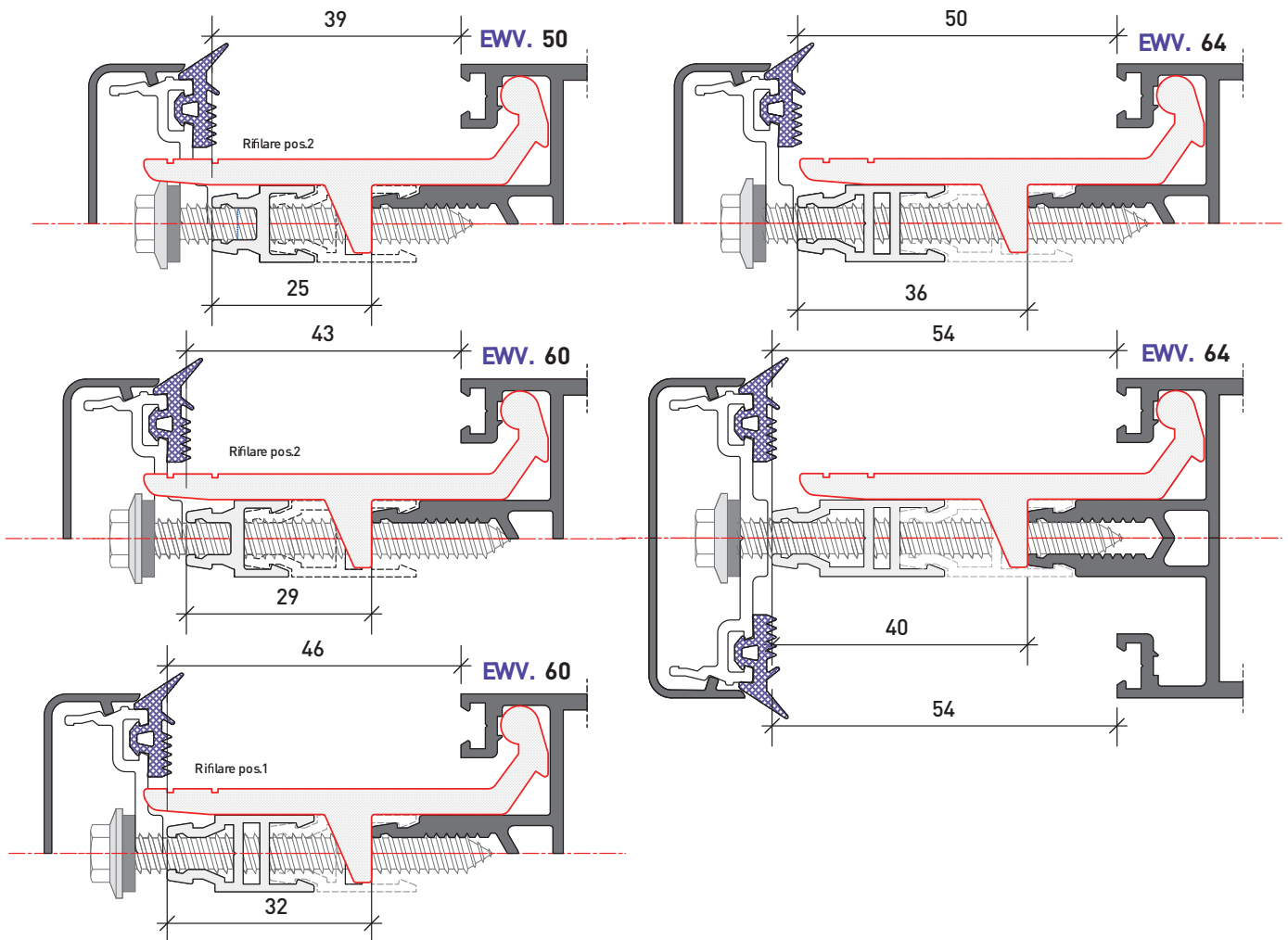

NOTE

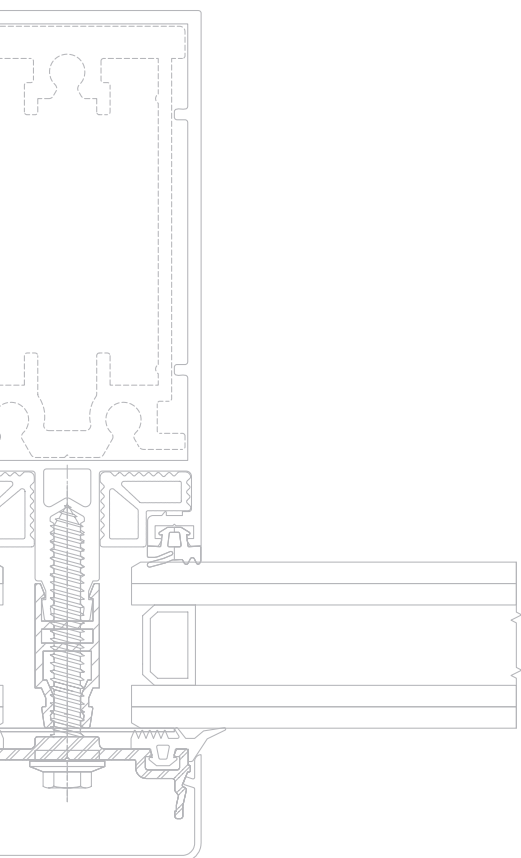

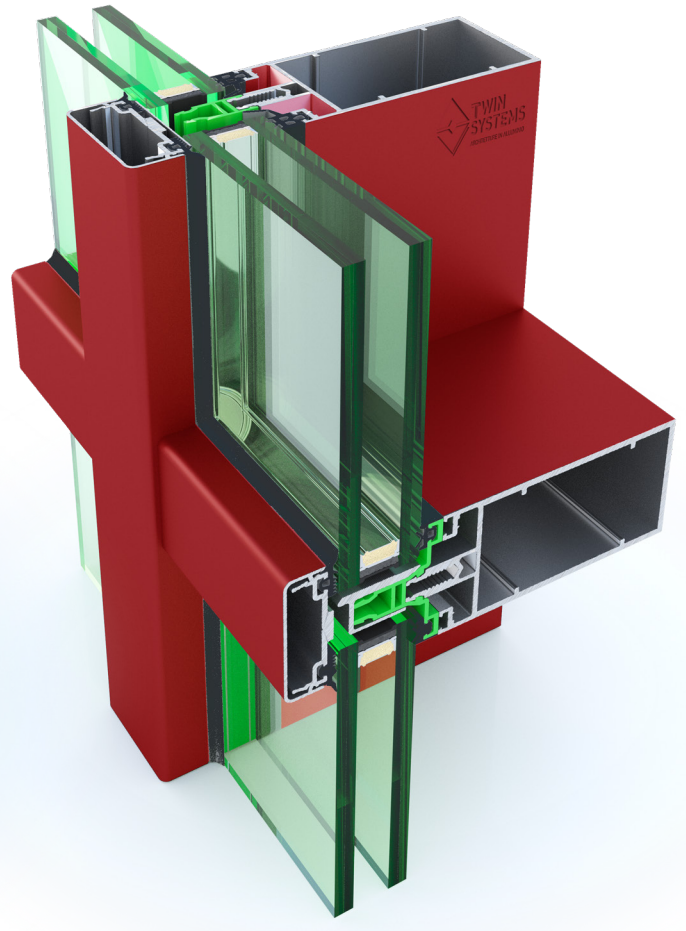
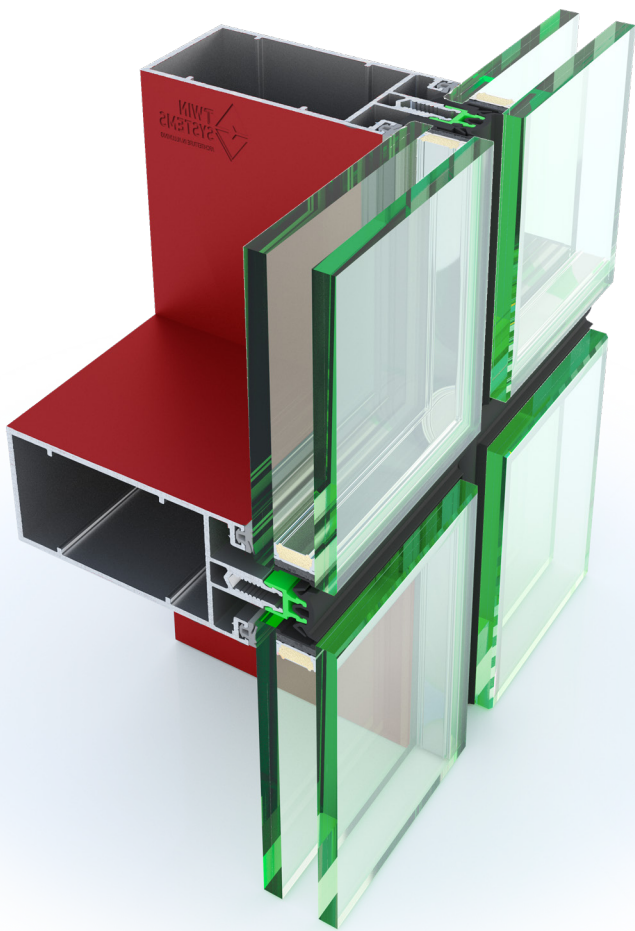

Evolution **GLASS**

Accessori e Guarnizioni
Accessories and Gaskets

Gruppo C















Evolution

Elenco accessori | *List of Accessories*
Elenco guarnizioni | *List of Window Gaskets*











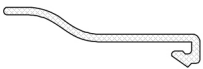

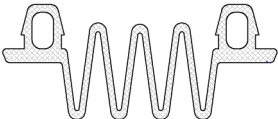
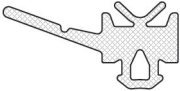

<p>EWA.001 Descrizione Description Cavallotto giunzione montanti/traversi Upright/Crosspiece junction U-bolt</p>		<p>EWA.010 Descrizione Description Spazzolino Telaio apribile Toothbrush Openable frame (4.8x5.5)</p>	
<p>EWA.003 Descrizione Description Caval. giunzione montanti/traversi ad aggancio U-bolt for jamb/crossbar connection</p>		<p>EWA.011 Descrizione Description Cavallotto giunzione frontale con viti a corredo Front junction U-bolt with supplied screws</p>	<p>IN ESAURIMENTO LOW</p> 
<p>EWA.004 Descrizione Description Appoggio vetro mm.80 EVOLUTION Glass support mm.80 EVOLUTION</p>		<p>EWA.012 Descrizione Description Bullone con dado e rondelle in Teflon Bolt with nut and Teflon washers (M12x100)</p>	
<p>EWA.005-40 Descrizione Description Nastro butilico da 40/80 mm. Per parti curve da 18° a 30° 40/80 mm. Butyl tape for curved parts from 18° to 30°</p>		<p>EWA.013 Descrizione Description Canotto per giunzione montanti Sleeve for upright junction L = 300mm.</p>	
<p>EWA.006 Descrizione Description Bloccaggio doppio per vetrate fisse in acciaio Double locking for fixed steel glazing</p>		<p>EWA.014 Descrizione Description Bloccaggio singolo per vetrate fisse in acciaio Single locking for fixed steel glazing</p>	
<p>EWA.007 Descrizione Description Squadr. Allineamento x anta a tiraggio meccanico Alignment bracket for mechanical draft sash</p>		<p>EWA.015 Descrizione Description Appoggio vetro mm.80 EVOLUTION Glass support mm.80 EVOLUTION</p>	
<p>EWA.008 Descrizione Description Squadr. giunzione DX anta/telaio tiraggio mecc. Right junction square for mechanical draft sash/frame</p>		<p>EWA.016 Descrizione Description Tappo per profilo R6204 in allestimento Cap for R6204 profile under construction</p>	
<p>EWA.009 Descrizione Description Squadr. giunzione SX anta/telaio tiraggio mecc. Left junction square for mechanical draft sash/frame</p>		<p>EWA.021 Descrizione Description Cavallotto in Acciaio U-bolt in steel</p>	

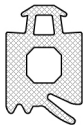

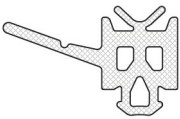
<p>EWA.022 Descrizione Description Coprivite Screw cover</p>		<p>EWB.03 Descrizione Description Distanziale in materiale plastico Spacer in plastic material 27 mm.</p>	
<p>EWA.055 Descrizione Description Tappo giunzione Trasverso R6200 (2 cavalotti) R6200 transverse junction cap (2 U-bolts) 55 mm.</p>		<p>EWB.03L Descrizione Description Dist. in mtl. pl. in barre con lavorazioni blocc. vetro Spacer in plastic material in bars with glass blocking processes 27 mm.</p>	
<p>EWA.100 Descrizione Description Tappo giunzione Trasverso R6201 (2 cavalotti) R6201 transverse junction cap (2 U-bolts) 100 mm.</p>		<p>EWB.04 Descrizione Description Dist. in mtl. pl. per telaio aperture a sporgere Plastic material spacer for projecting opening frame</p>	
<p>EWA.150 Descrizione Description Tappo giunzione Trasverso R6202 (2 cavalotti) R6202 transverse junction cap (2 U-bolts) 150 mm.</p>		<p>EWB.05 Descrizione Description Dist. in mtl. pl. per telaio aperture a sporgere Plastic material spacer for projecting opening frame</p>	
<p>EWA.200 Descrizione Description Tappo giunzione Trasverso R6203 (2 cavalotti) R6203 transverse junction cap (2 U-bolts) 200 mm.</p>		<p>EWB.06 Descrizione Description Canalina in mtl. Plastico per vetrocamera Plastic channel for double glazing</p>	
<p>EWA.250 Descrizione Description Tappo giunzione Trasverso R6231 (2 cavalotti) R6231 transverse junction cap (2 U-bolts) 250 mm.</p>		<p>EWB.07 Descrizione Description Profilo in mtl. Plastico per giunzione montanti Profile in plastic material for joining uprights</p>	
<p>EWB.01 Descrizione Description Distanziale in materiale plastico Spacer in plastic material 16 mm.</p>		<p>BX 34 Descrizione Description Profilo in poliammide per trasverso Polyamide profile for transom</p>	
<p>EWB.02 Descrizione Description Distanziale in materiale plastico Spacer in plastic material 23 mm.</p>			

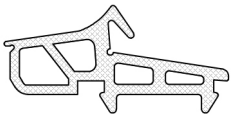

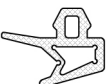

<p>EWG.01 Descrizione Description Guarnizione est. per montanti/traversi da mm. 3.5 External gasket for mullions/transoms mm. 3.5</p>		<p>EWG.07 Descrizione Description Guarnizione superiore per telaio apribile Upper seal for opening frame</p>	
<p>EWG.02 Descrizione Description Guarnizione int. per montanti/traversi da mm. 3 Internal gasket for mullions/transoms mm. 3</p>	 <p>Incompatibile con EWA.011 Incompatible with EWA.011</p>	<p>EWG.08.SIL Descrizione Description Guarnizione est. per strutturale External gasket for structural</p>	 <p>Siliconica</p>
<p>EWG.03 Descrizione Description Guarnizione int. per montanti/traversi da mm. 5 Internal gasket for mullions/transoms mm. 5</p>		<p>EWG.09 Descrizione Description Guarnizione per compensazione laterale Lateral compensation seal</p>	
<p>EWG.03L Descrizione Description Guarnizione int. per montanti/traversi da mm. 5 Internal gasket for mullions/transoms mm. 5</p>		<p>EWG.10 Descrizione Description Guarnizione sottovetro per traversi Under glass gasket for transoms</p>	
<p>EWG.04 Descrizione Description Guarnizione int. per montanti/traversi da mm. 9 Internal gasket for mullions/transoms mm. 9</p>		<p>EWG.11 Descrizione Description Guarnizione int. per montanti/traversi da mm. 7 Internal gasket for mullions/transoms mm. 7</p>	
<p>EWG.04L Descrizione Description Guarnizione int. per montanti/traversi da mm. 9 Internal gasket for mullions/transoms mm. 9</p>		<p>EWG.012 Descrizione Description Guarnizione Traversi in comb. BX34+EWG.04/04L Transom seal in combination BX34+EWG.04/04L</p>	
<p>EWG.05.SIL Descrizione Description Guarnizione tenuta est. anta a sporgere External sealing gasket for protruding leaf</p>	 <p>Siliconica</p>	<p>EWG.013 Descrizione Description Guarniz. Aprib. Realizzare solo x Traversi Mobili Openable gasket. Made only for Traversi Mobili</p>	
<p>EWG.06 Descrizione Description Guarnizione tenuta int. telaio apertura est. External opening frame internal sealing gasket</p>			





<p>EWA.ST1 Descrizione Description Staffa frontale asola verticale Vertical slot front bracket</p>		<p>EWV.25 Descrizione Description Vite Inox A2 AISI 304 (Din 6928/UNI 6950) A2 AISI 304 stainless steel screw (Din 6928/UNI 6950) 6,3 mm. X 25 mm.</p>	
<p>EWA.ST2 Descrizione Description Staffa frontale asola orizzontale Horizontal slot front bracket</p>		<p>EWV.32 Descrizione Description Vite Inox A2 AISI 304 (Din 6928/UNI 6950) A2 AISI 304 stainless steel screw (Din 6928/UNI 6950) 6,3 mm.x32 mm.</p>	
<p>EWA.ST3 Descrizione Description Staffa frontale/laterale asola verticale Vertical slot front/side bracket</p>		<p>EWV.38 Descrizione Description Vite Inox A2 AISI 304 (Din 6928/UNI 6950) A2 AISI 304 stainless steel screw (Din 6928/UNI 6950) 6,3 mm.x38 mm.</p>	
<p>EWA.ST4 Descrizione Description Staffa frontale/laterale asola orizzontale Front/side horizontal slot bracket</p>		<p>EWV.45 Descrizione Description Vite Inox A2 AISI 304 (Din 6928/UNI 6950) A2 AISI 304 stainless steel screw (Din 6928/UNI 6950) 6,3 mm.x45 mm.</p>	
<p>EWA.ST7 Descrizione Description Staffa attacco nascosto per soffitto/pavimento Concealed attachment bracket for ceiling/floor H = 200 mm.</p>		<p>EWV.50 Descrizione Description Vite Inox A2 AISI 304 (Din 6928/UNI 6950) A2 AISI 304 stainless steel screw (Din 6928/UNI 6950) 6,3 mm.x50 mm.</p>	
<p>EWV.45AF Descrizione Description Autofilettante Testa Piana Svasata, din 7982, (A2K) Countersunk Flat Head Self Tapping Screw, din 7982, (A2K) 6,3 mm.x45 mm.</p>		<p>EWV.60 Descrizione Description Vite Inox A2 AISI 304 (Din 6928/UNI 6950) A2 AISI 304 stainless steel screw (Din 6928/UNI 6950) 6,3 mm.x60 mm.</p>	
<p>EWV.25G Descrizione Description Vite Inox per EWA021 Stainless steel screw 6,3 mm.x25 mm.</p>		<p>EWV.64 Descrizione Description Vite Inox A2 AISI 304 (Din 6928/UNI 6950) A2 AISI 304 stainless steel screw (Din 6928/UNI 6950) 6,3 mm.x64 mm.</p>	
<p>EWV.75 Descrizione Description Vite Inox A2 AISI 304 (Din 6928/UNI 6950) A2 AISI 304 stainless steel screw (Din 6928/UNI 6950) 6,3 mm.x75 mm.</p>		<p>EWV.75 Descrizione Description Vite Inox A2 AISI 304 (Din 6928/UNI 6950) A2 AISI 304 stainless steel screw (Din 6928/UNI 6950) 6,3 mm.x75 mm.</p>	



ACX 10.04	
Descrizione Description Guarnizione di Battuta ad Infilo	
Stop Gasket to insert	

ACX 49.SQ	
Descrizione Description Squadra di Allineamento	
Alignin Corner Joint	

AHX 10.48	
Descrizione Description Guarnizione Perimetraele Ana	
Perimetral Sash Gasket	

LM 0164	
Descrizione Description Squadra di Allineamento	
Alignin Corner Joint	

AVL 30.11	
Descrizione Description "TOP RAPID" Cerniera ad aggancio rapido a 2 ali	
"TOP RAPID" 2 Wings Fast Hanging Hinge	

EWA 023	
Descrizione Description Tappo Chiuditubolarita per Facciate Inclinate	
Closing Holes Cap for inclined Facades	

AVL 30.12	
Descrizione Description "TOP RAPID" Cerniera ad aggancio rapido a 3 ali	
"TOP RAPID" 3 Wings Fast Hanging Hinge	

LM 7511	
Descrizione Description Squadra giunzione e allineamento	
Alining and Pairing Corner Joint	

LM 7606	
Descrizione Description Squadra giunzione e allineamento c/viti serraggio	
Alining and Pairing Corner Joint w/ tightening Screws	

AWX 19.SQ	
Descrizione Description Squadra giunzione	
Corner Joint	

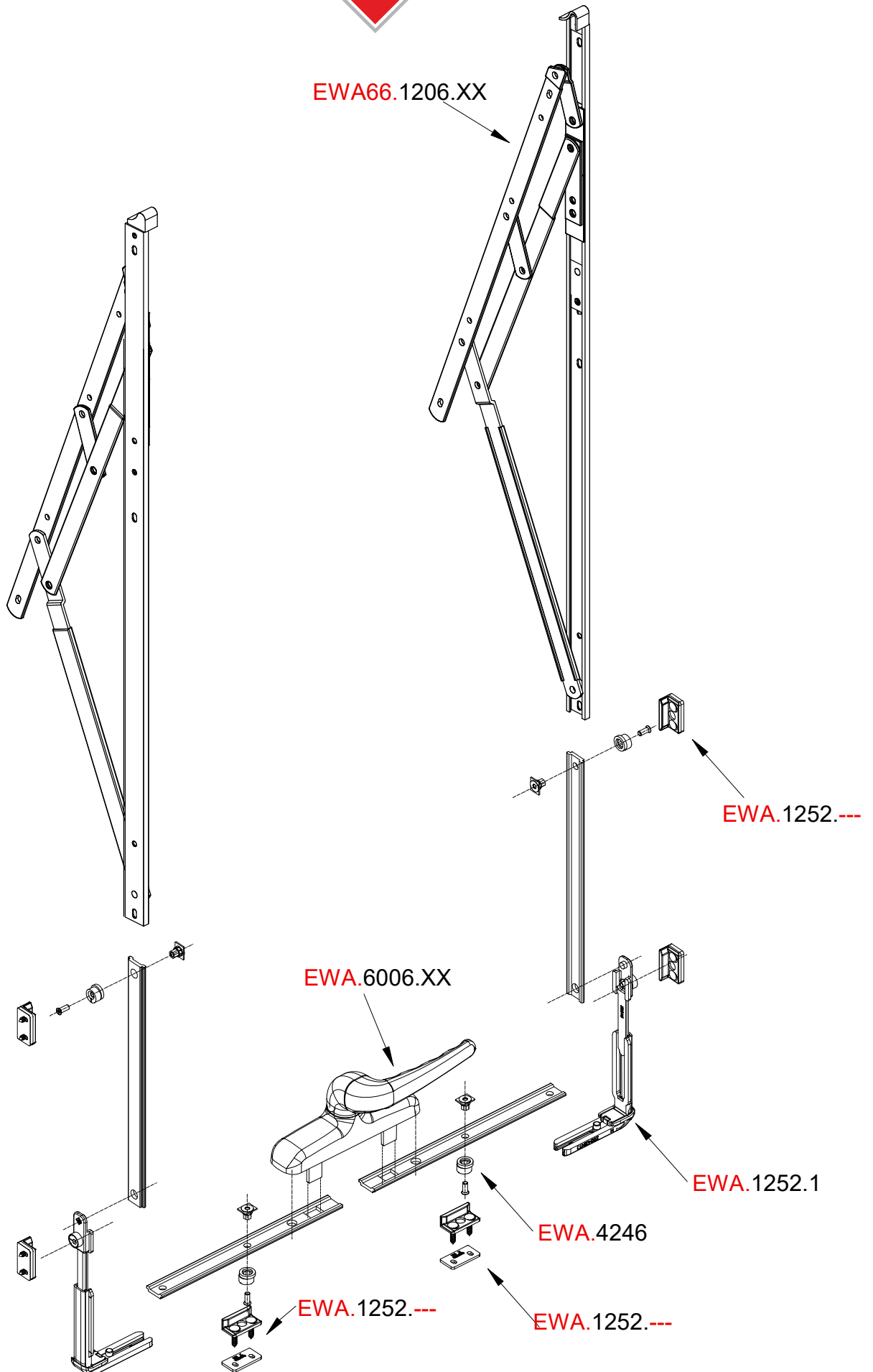

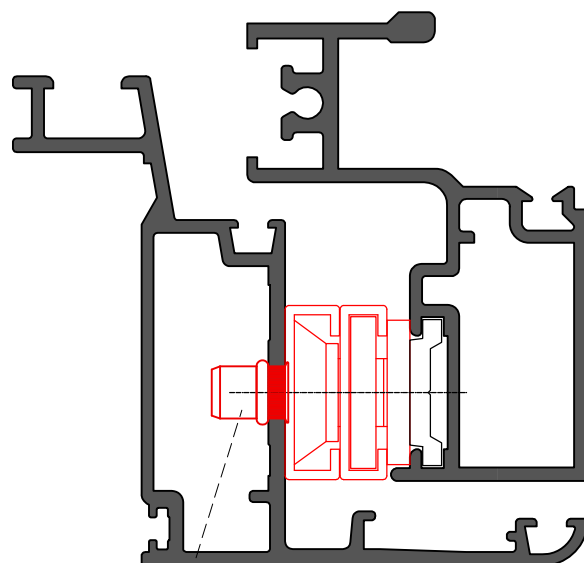
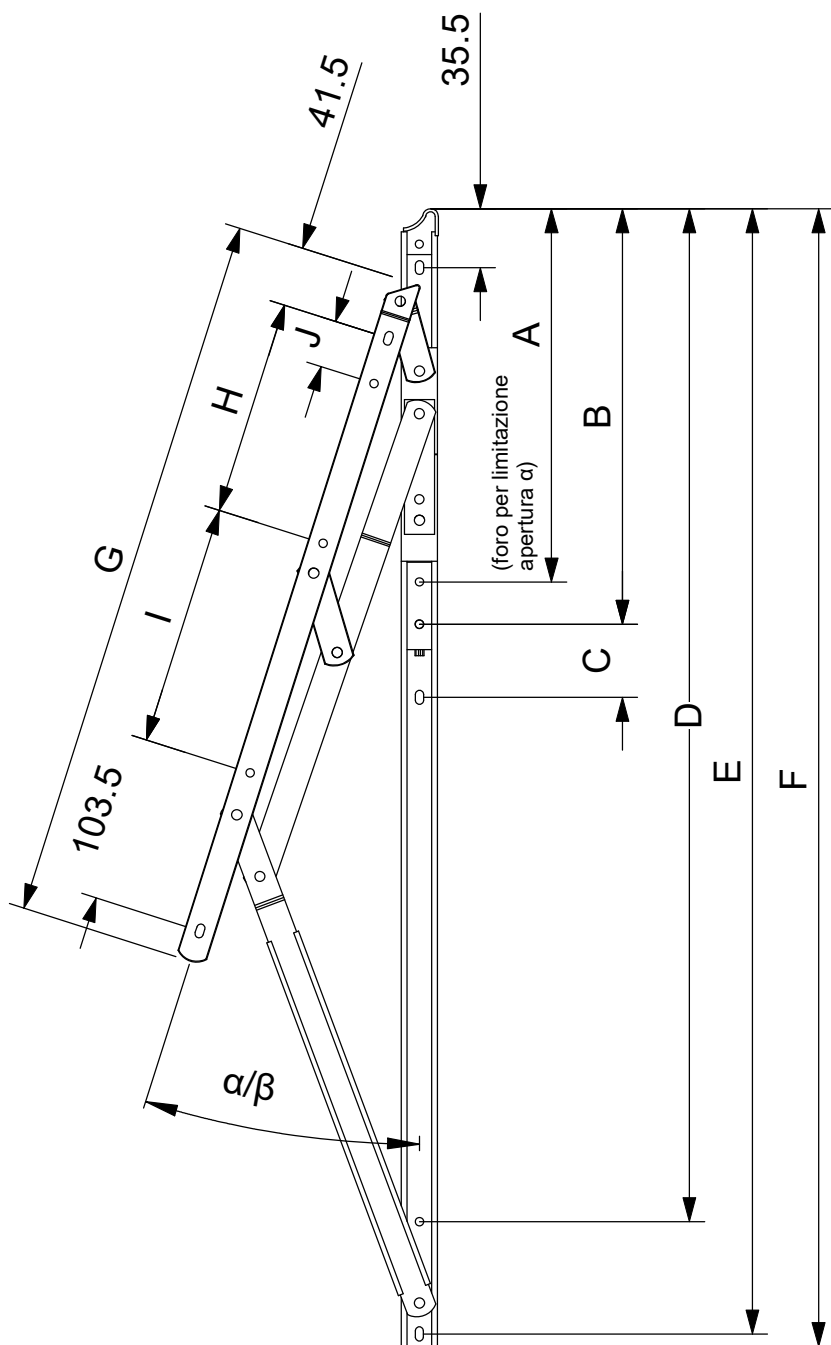

Inserto filettato a filo M5 + Loctite
M5 flush threaded insert + Loctite

Campo di Applicazione
Field of application

Articolo Item	Apert. (α/β)	Portata (Kg.)	Min-Max H (mm)	Max L (mm)
EWA.1206.10	35/45	50/36	450/600	1200
EWA.1206.12	30/40	70/43	600/800	1200
EWA.1206.14	30/40	80/50	800/1000	1200
EWA.1206.16	25/35	95/65	1000/1200	1200
EWA.1206.18	25/35	108/78	1200/1400	1500
EWA.1206.20	20/30	115/90	1400/1600	1600
EWA.1206.22	20/30	120/100	1600/1800	1800
EWA.1206.24	20/25	130/120	1600/1800	1800
EWA.1206.28	10/20	145/140	1800/2000	2000

Articolo Item	β	α	A	B	C	D	E	F	G	H	I	J
EWA.1206.10	45	35	160	183,5	n.p.	211,5	254	263	205	40	n.p.	n.p.
EWA.1206.12	40	30	172,5	214	n.p.	249,5	305	313	252,5	40	40	n.p.
EWA.1206.14	40	30	180,5	227	n.p.	288	344	351	275	40	70	n.p.
EWA.1206.16	35	25	173	225	46	348	404,5	412,5	313,5	40	108,5	n.p.
EWA.1206.18	35	25	179,5	239,5	46	393	450	458,5	340	70	105	n.p.
EWA.1206.20	30	20	174	228	46	448	503,5	512	376	89,5	121,5	n.p.
EWA.1206.22	30	20	182	241	46	494	547,5	555,5	403,5	103	135,5	n.p.
EWA.1206.24	25	20	246	270,5	46	538	594,5	602	430	135	130	30
EWA.1206.28	20	10	230	261,5	46	637,5	707	715	452	135	152	30



Portata bracci con e senza limitatore di apertura
Arm capacity with and without opening limiter

Art. \ α	3°	8°	10°	15°	20°		
EWA.1206.28	165 Kg	155 Kg	148 Kg	143 Kg	140 Kg		
Braccio <i>Boom</i>	1203.X	1203.X					
Limitatore <i>Limiter</i>	1204.X X	1204.X X	-	1250	-		
Consigliato <i>Recommended</i>	1205.X X	1205.X X					
Art. \ α	5°	10°	15°	20°	25°		
EWA.1206.24	150 Kg	145 Kg	138 Kg	130 Kg	120 Kg		
Braccio <i>Boom</i>	1203.X	1203.X					
Limitatore <i>Limiter</i>	1204.X X	1204.X X	1250	-	-		
Consigliato <i>Recommended</i>	1205.X X	1205.X X					
Art. \ α	5°	10°	15°	20°	25°	30°	
EWA.1206.22	145 Kg	139 Kg	132 Kg	125 Kg	118 Kg	110 Kg	
Braccio <i>Boom</i>	1203.X	1203.X					
Limitatore <i>Limiter</i>	1204.X X	1204.X X	1250	-	1250	-	
Consigliato <i>Recommended</i>	1205.X X	1205.X X					
Art. \ α	6°	10°	15°	20°	25°	30°	
EWA.1206.20	140 Kg	135 Kg	128 Kg	120 Kg	111 Kg	100 Kg	
Braccio <i>Boom</i>	1203.X	1203.X					
Limitatore <i>Limiter</i>	1204.X X	1204.X X	1250	-	1250	-	
Consigliato <i>Recommended</i>	1205.X X	1205.X X					
Art. \ α	7°	10°	15°	20°	25°	30°	35°
EWA.1206.18	130 Kg	128 Kg	123 Kg	116 Kg	105 Kg	91 Kg	75 Kg
Braccio <i>Boom</i>	1203.X	1203.X					
Limitatore <i>Limiter</i>	1204.X X	1204.X X	1250	1250	-	1250	
Consigliato <i>Recommended</i>	1205.X X	1205.X X					
Art. \ α	8°	15°	20°	25°	30°	35°	
EWA.1206.16	115 Kg	111 Kg	105 Kg	95 Kg	82 Kg	65 Kg	
Braccio <i>Boom</i>	1203.X	1203.X					
Limitatore <i>Limiter</i>	1204.X X	1204.X X	1250	-	1250	-	
Consigliato <i>Recommended</i>	1205.X X	1205.X X					
Art. \ α	10°	15°	20°	25°	30°	35°	40°
EWA.1206.14	95 Kg	92 Kg	87 Kg	80 Kg	72 Kg	65 Kg	50 Kg
Braccio <i>Boom</i>	1203.X	1203.X					
Limitatore <i>Limiter</i>	1204.X X	1204.X X	1250	1250	-	1250	-
Consigliato <i>Recommended</i>	1205.X X	1205.X X					
Art. \ α	10°	15°	20°	25°	30°	35°	40°
EWA.1206.12	80 Kg	79 Kg	77 Kg	72 Kg	65 Kg	56 Kg	40 Kg
Braccio <i>Boom</i>	1203.X	1203.X	1203.X				
Limitatore <i>Limiter</i>	1204.X X	1204.X X	1204.X X	1250	-	1250	-
Consigliato <i>Recommended</i>	1205.X X	1205.X X	1205.X X				
Art. \ α	15°	20°	25°	30°	35°	40°	
EWA.1206.10	55 Kg	50 Kg	47 Kg	44 Kg	40 Kg	35 Kg	
Braccio <i>Boom</i>	1203.X	1203.X					
Limitatore <i>Limiter</i>	1204.X X	1204.X X	1250	1250	-	-	
Consigliato <i>Recommended</i>	1205.X X	1205.X X					

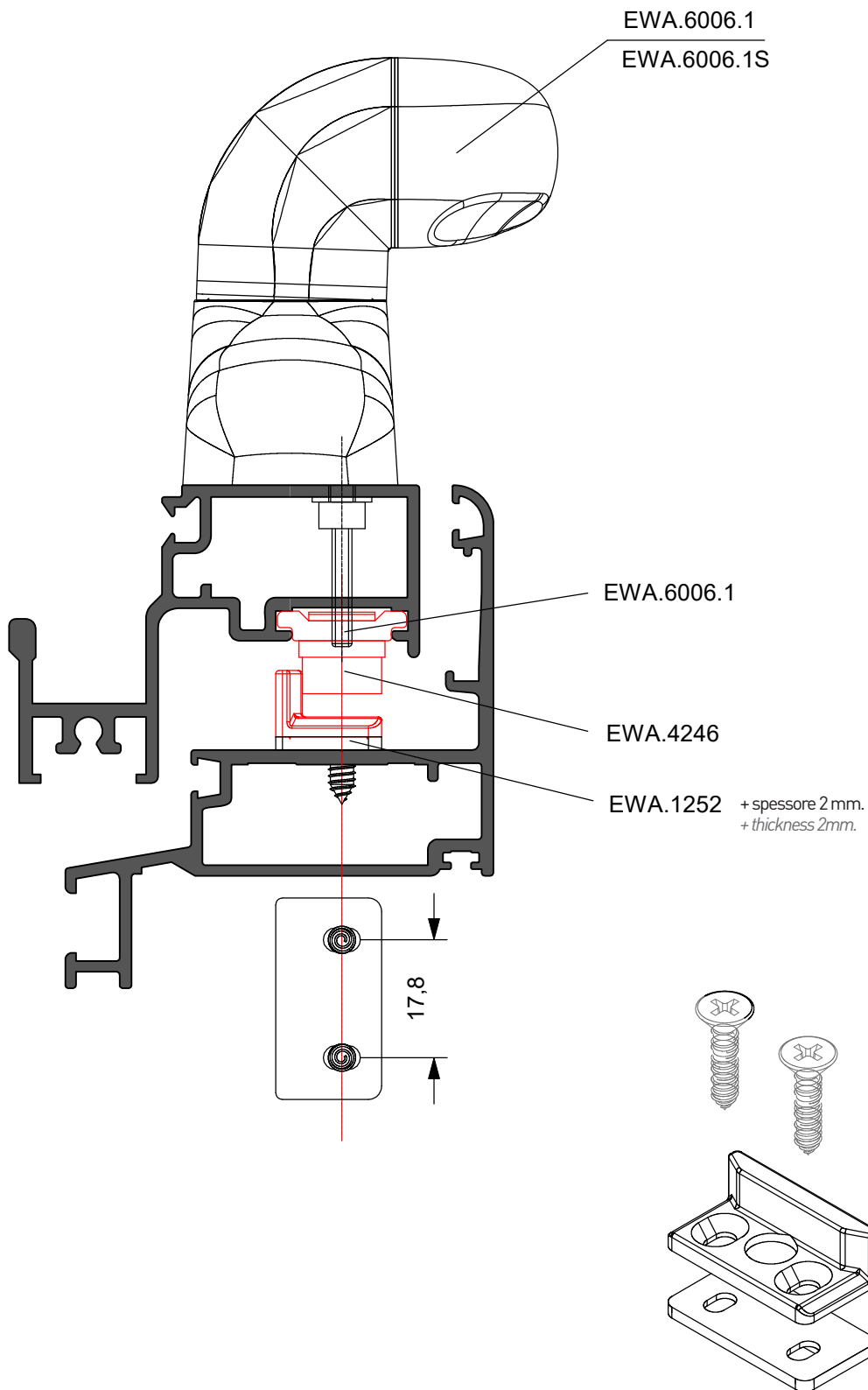



EWA.1205.3

Braccio limitatore frizionato
Friction limiter arm

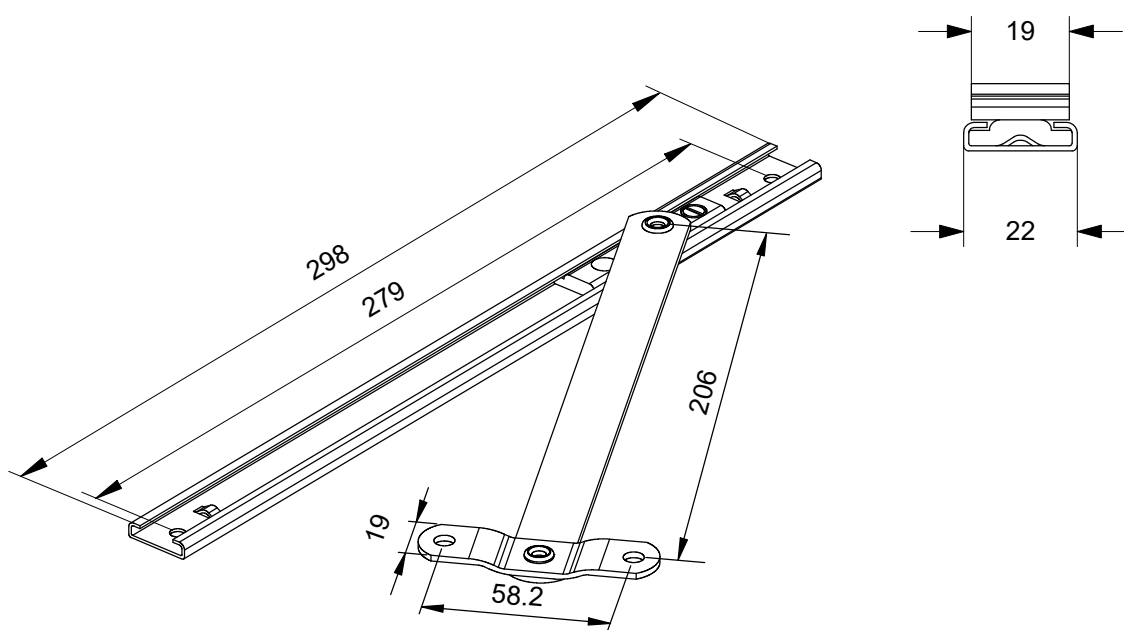
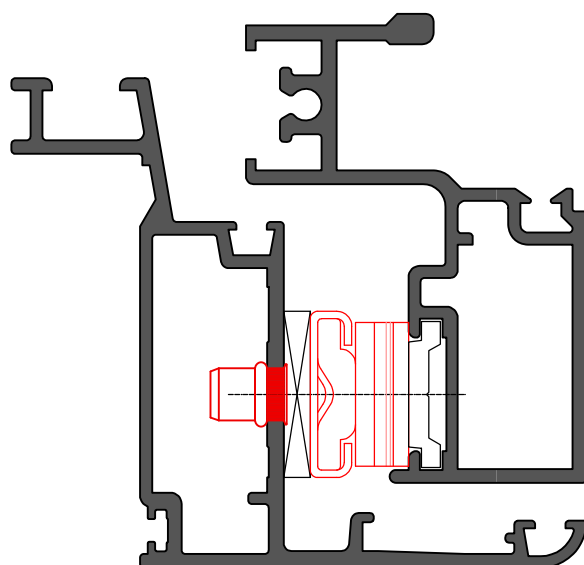



EWA.1204.XX

Braccio limitatore a scatto
Snap limiter arm

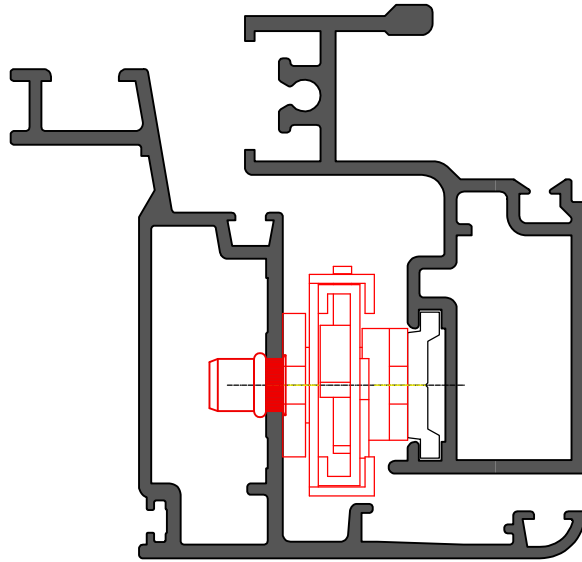

Articolo Item	L1	L2
EWA.1204.8	205	150
EWA.1204.10	255	175
EWA.1204.12	305	200

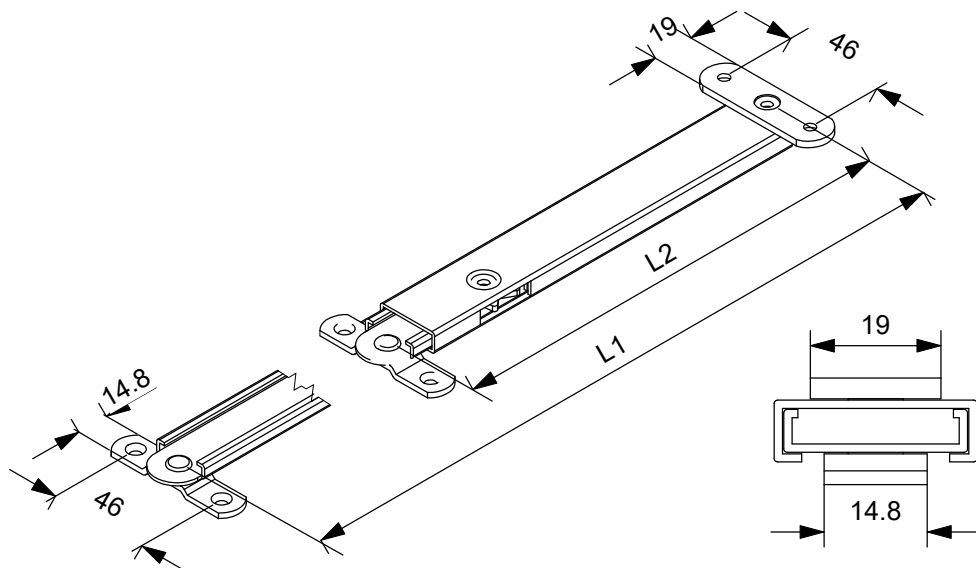



EWA.1203.X

Braccio limitatore frizionato con chiave di sgancio

Frictioned limiter arm with release key

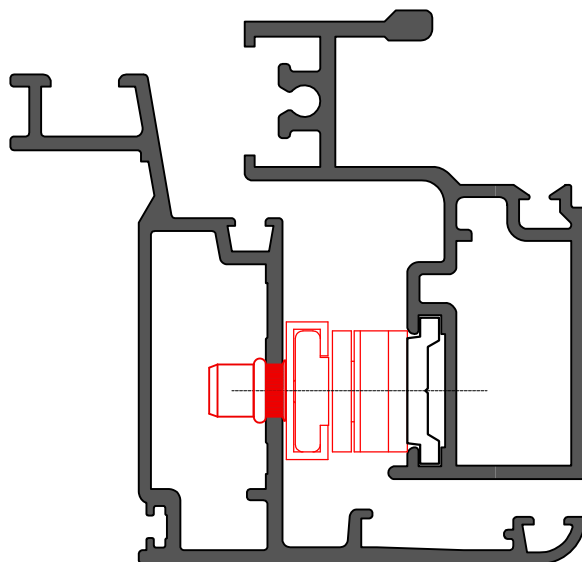

Articolo Item	L1	L2	L3
EWA.1203.6	131	150	85
EWA.1203.8	185	202	152
EWA.1203.10	236	254	202
EWA.1203.1	Chiave supplementare <i>Additional key</i>		

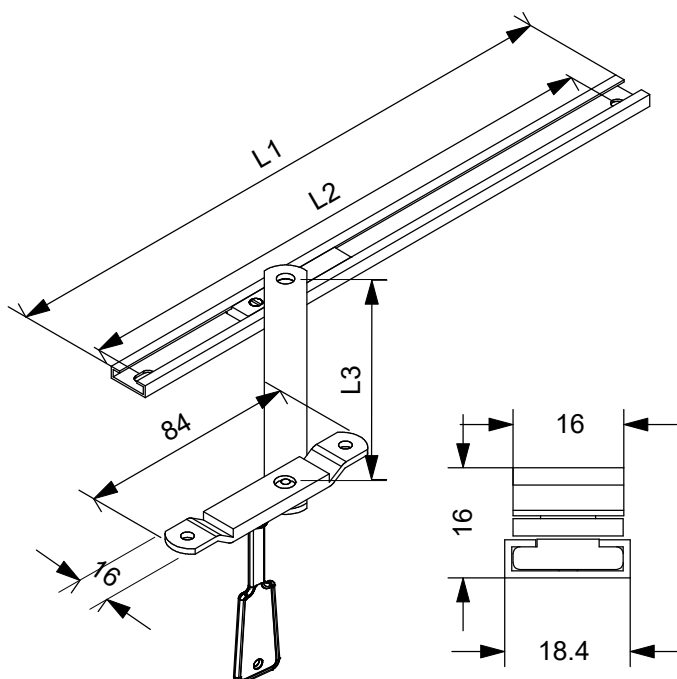



Applic. guarnizioni e distanziali

Gasket and spacer applications

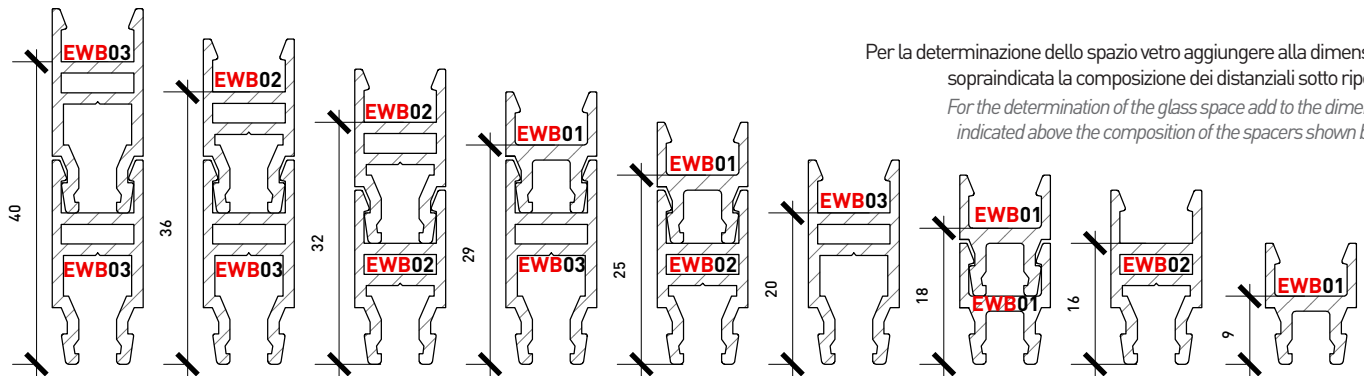
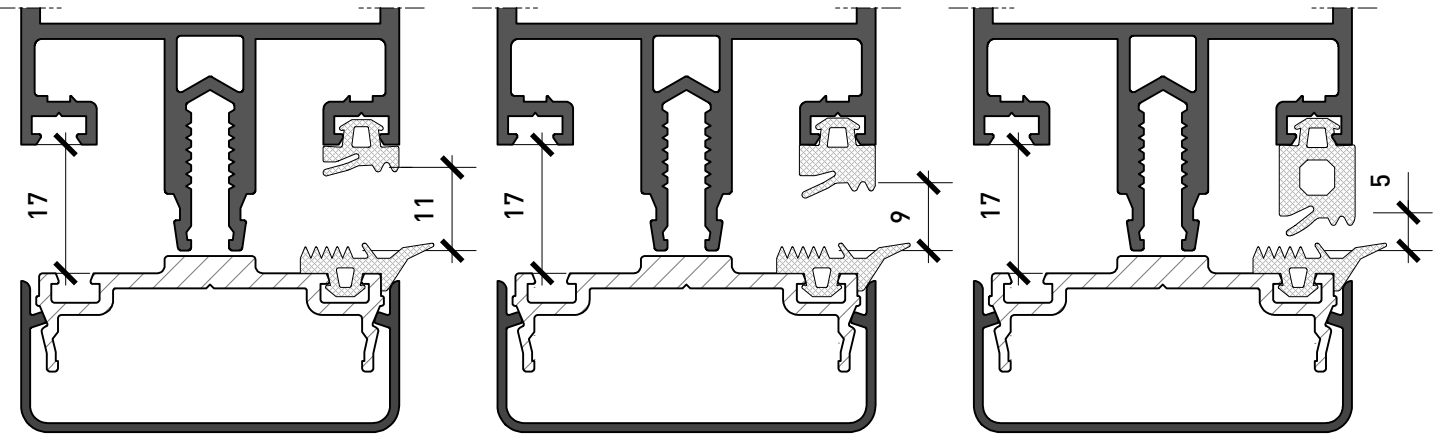
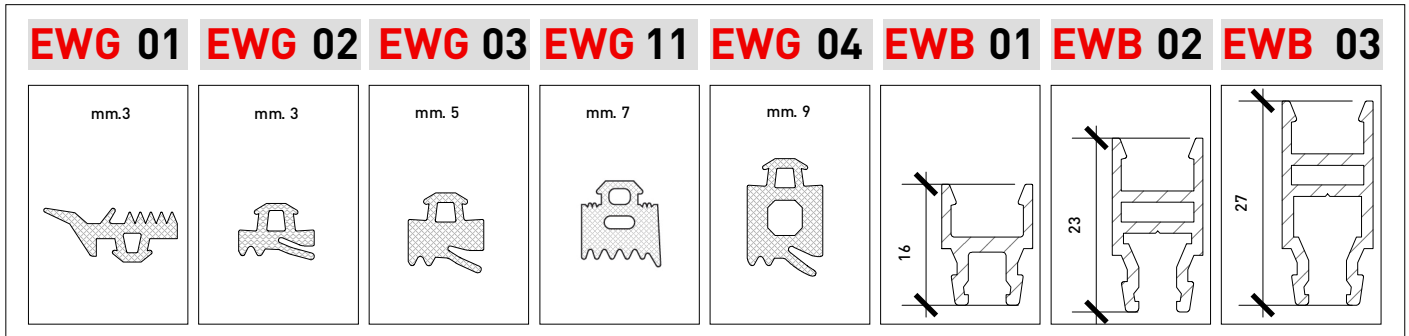

Per la determinazione dello spazio vetro aggiungere alla dimensione sopraindicata la composizione dei distanziali sotto riportati
For the determination of the glass space add to the dimension indicated above the composition of the spacers shown below

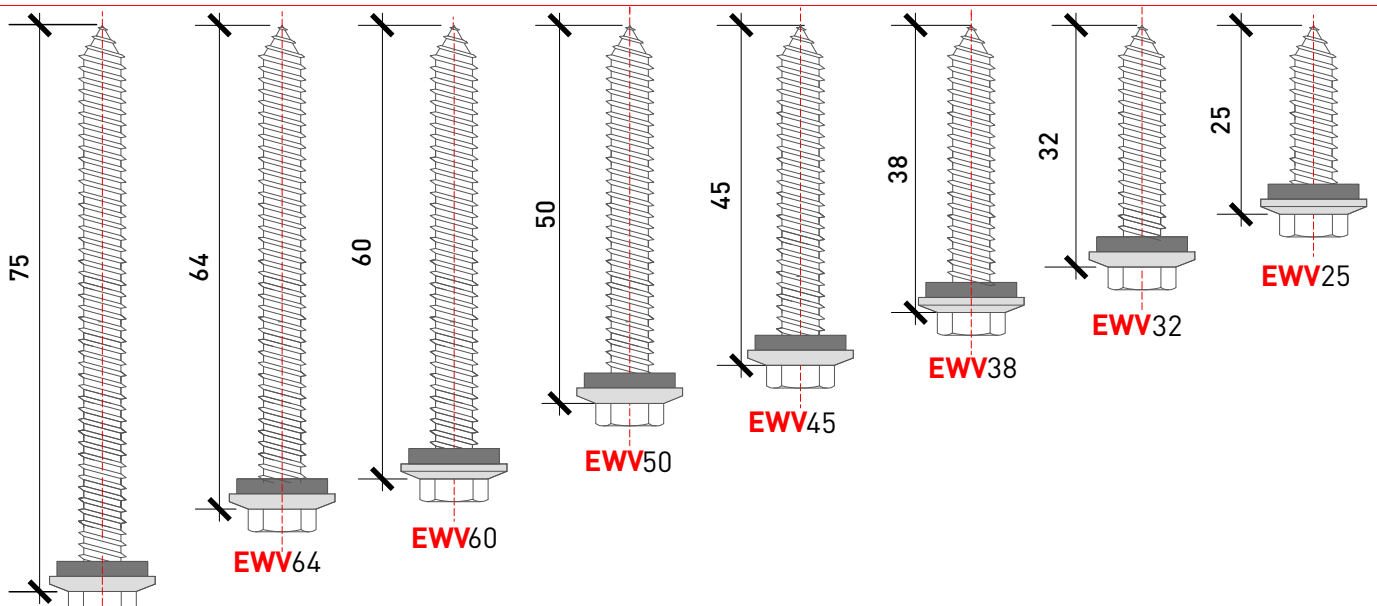

Applicazioni viti
Screw applications

Evolution

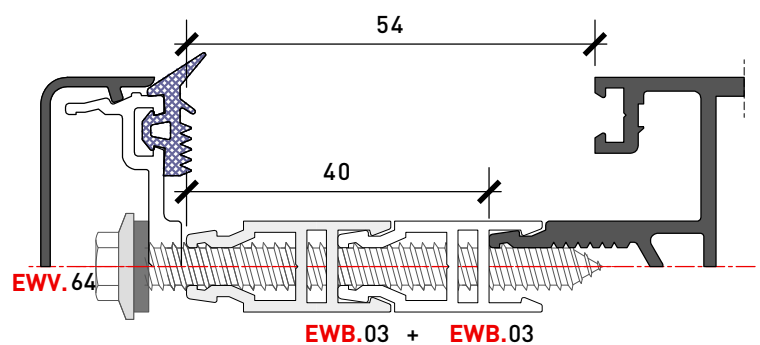
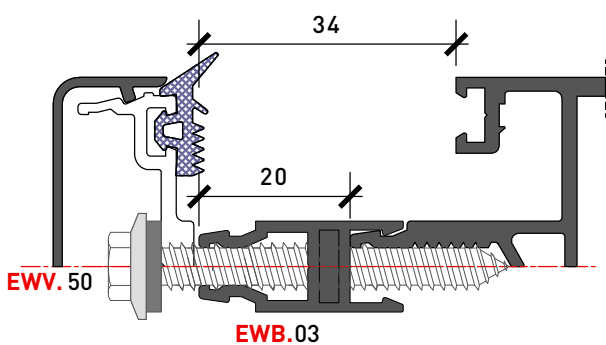
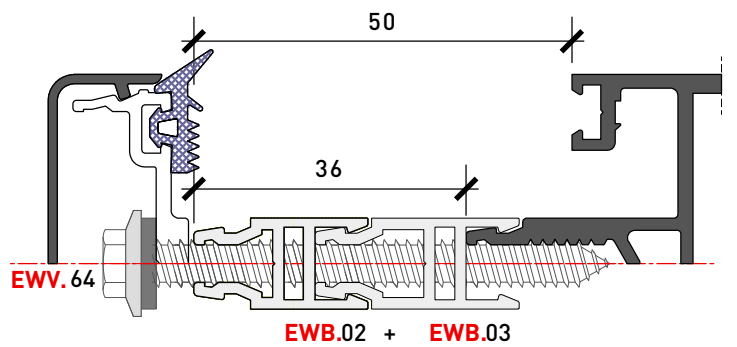
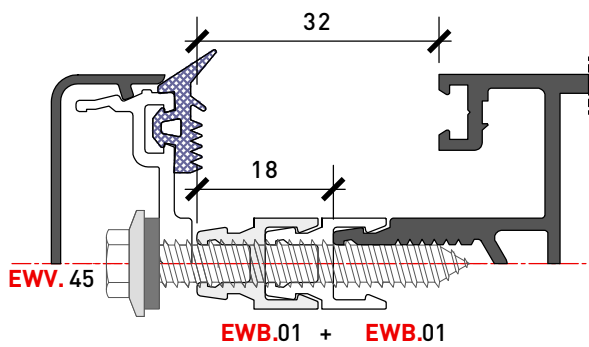
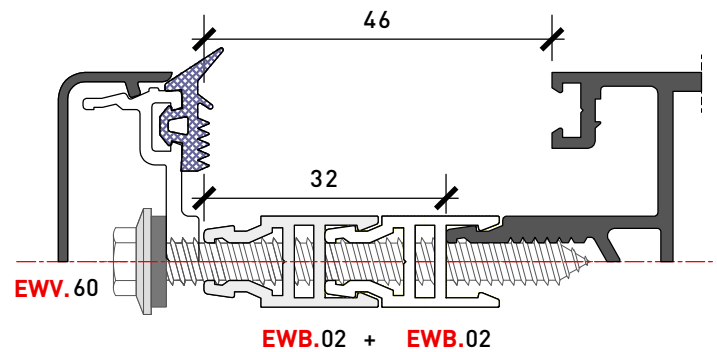
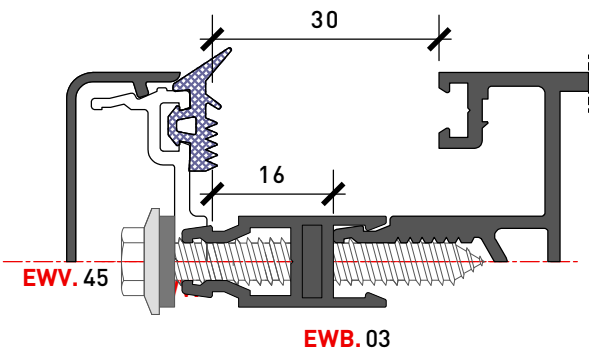
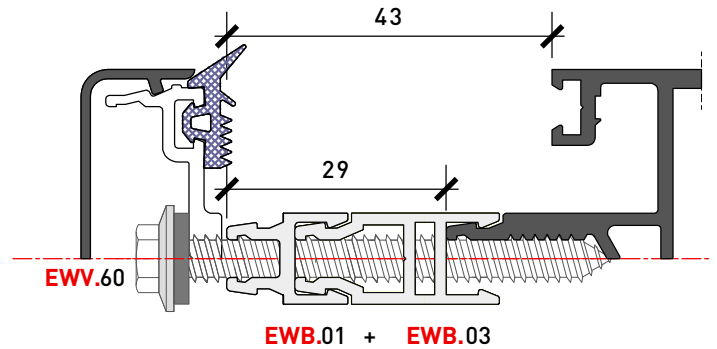
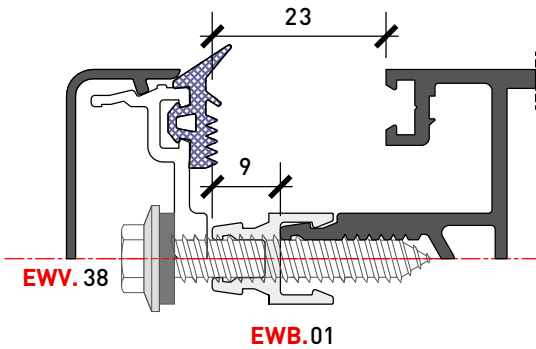
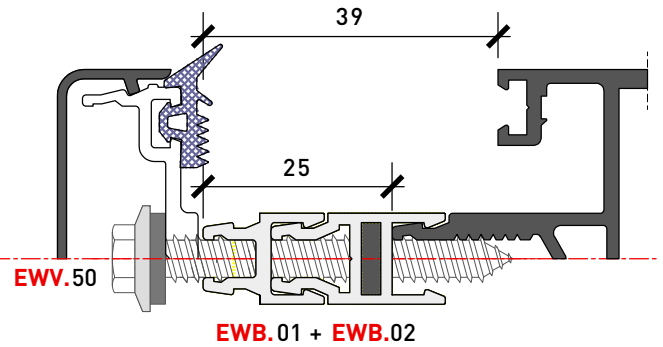
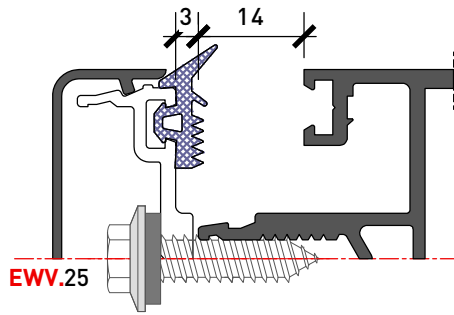



R6233

SUPPORTO VETRO MAGGIORATO

INCREASED GLASS SUPPORT

Evolution

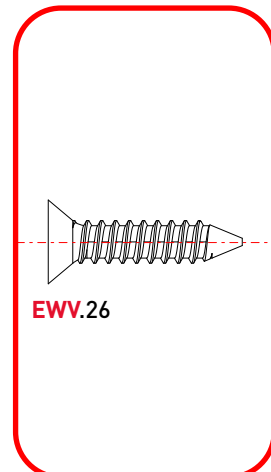
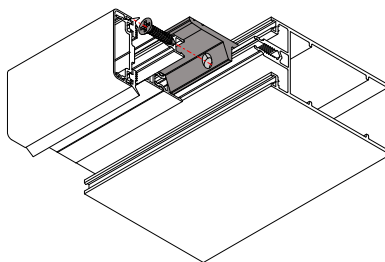
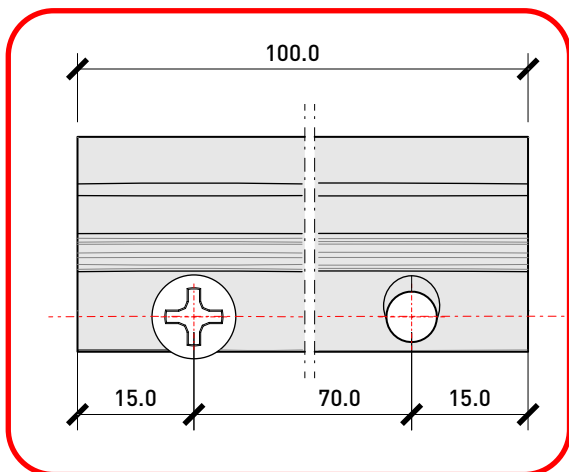
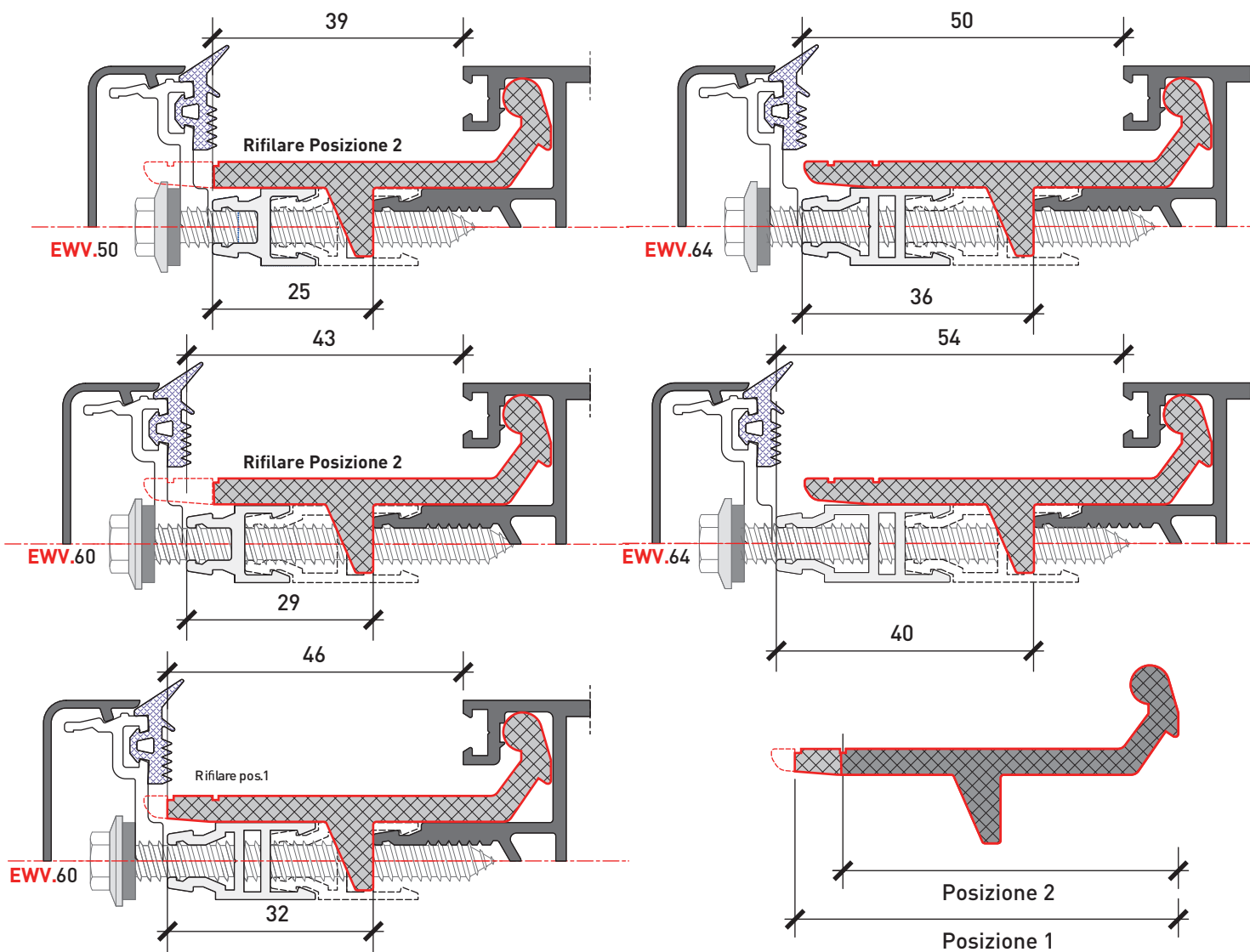



R6226

SUPPORTO VETRO

GLASS SUPPORT

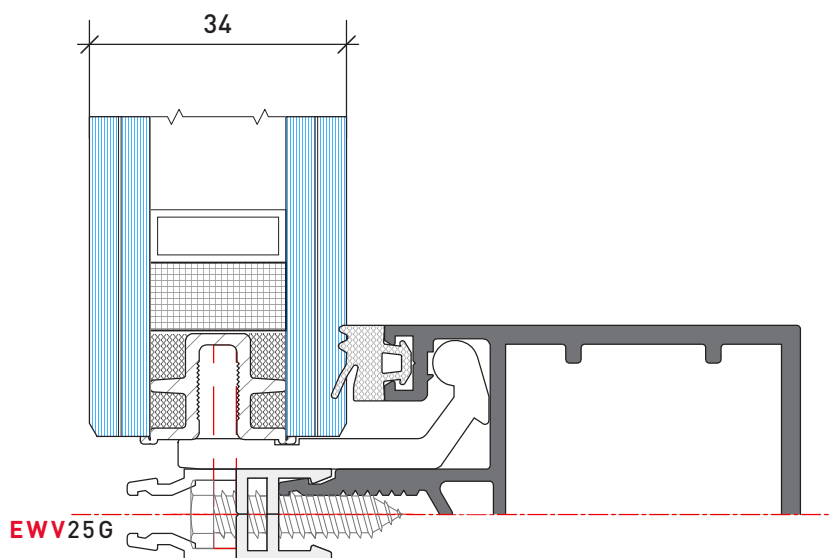
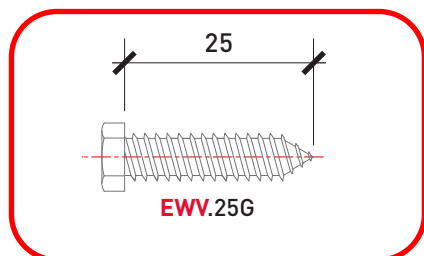

R6233

SUPPORTO VETRO MODULARE MODULAR GLASS SUPPORT

Evolution

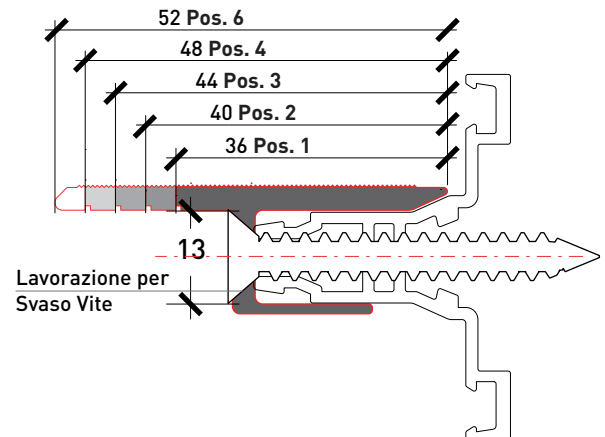
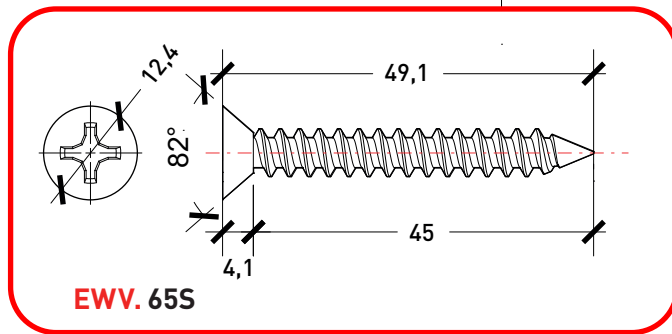
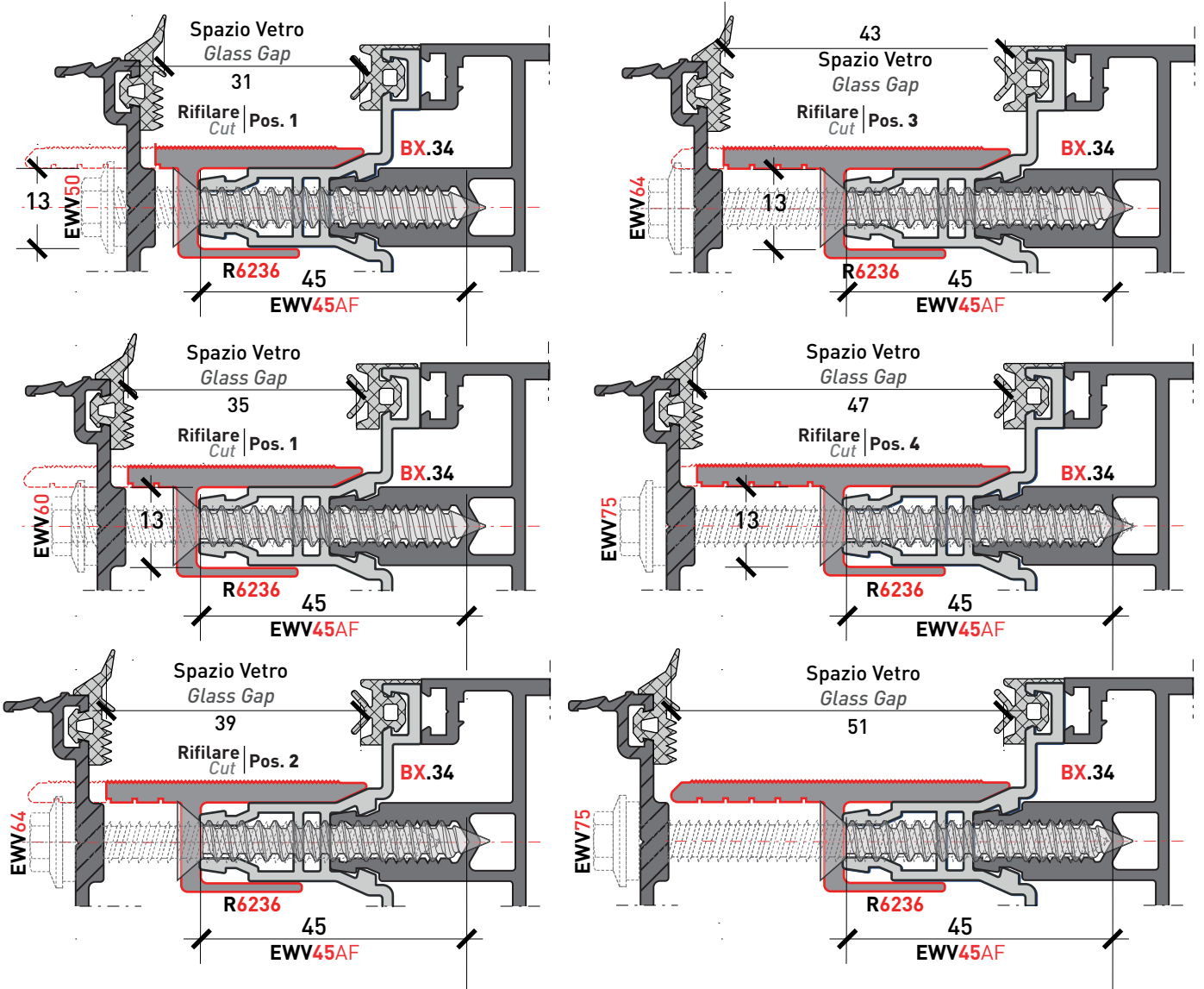

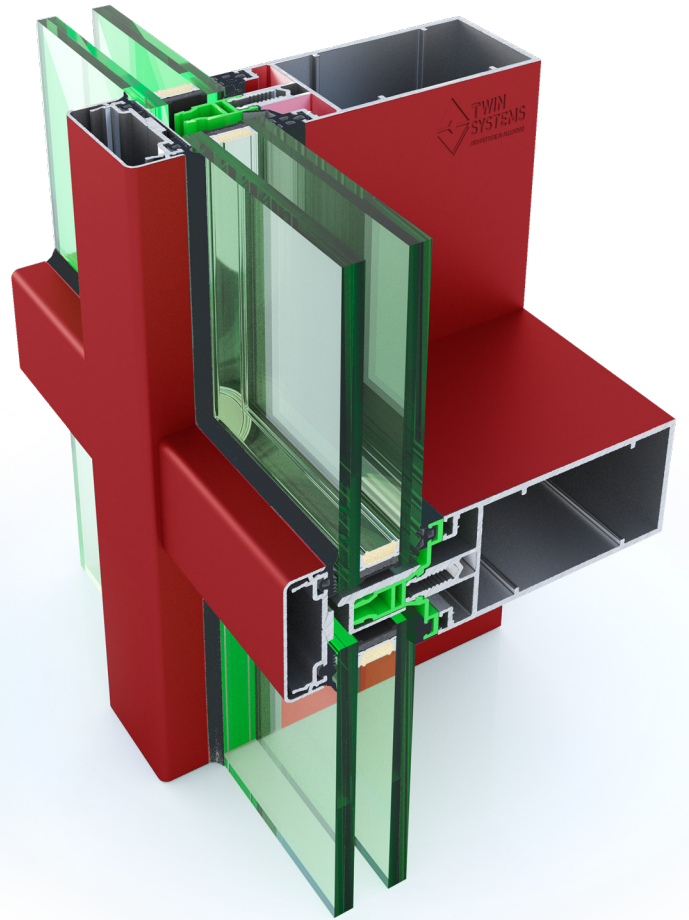
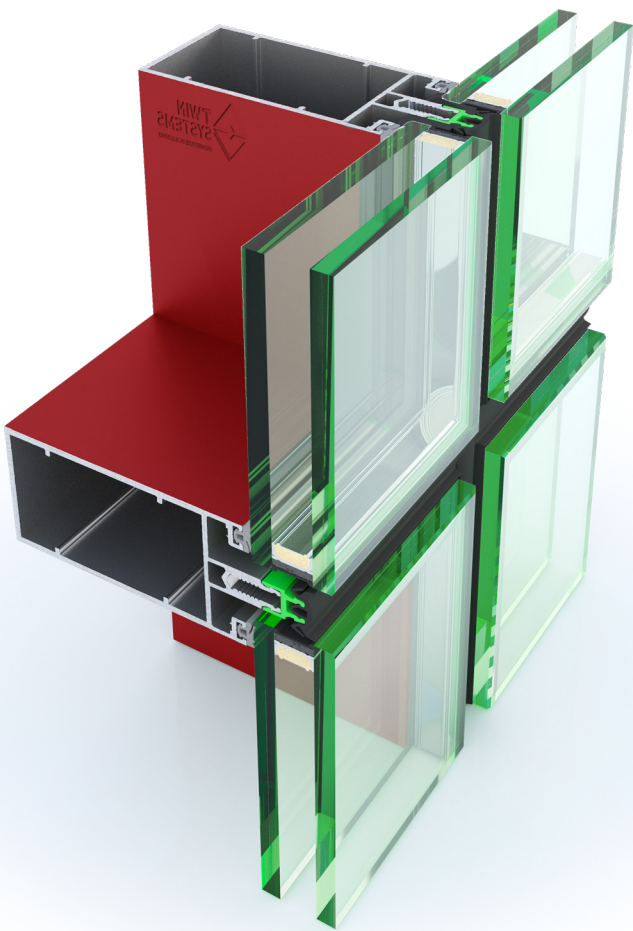

Evolution **GLASS**

Evolution

Nodi
Main Sections

Gruppo D

Sezioni principali
e Accessori
Sc. 1:1

Main Sections and
Accessories
Scale 1:1



Evolution

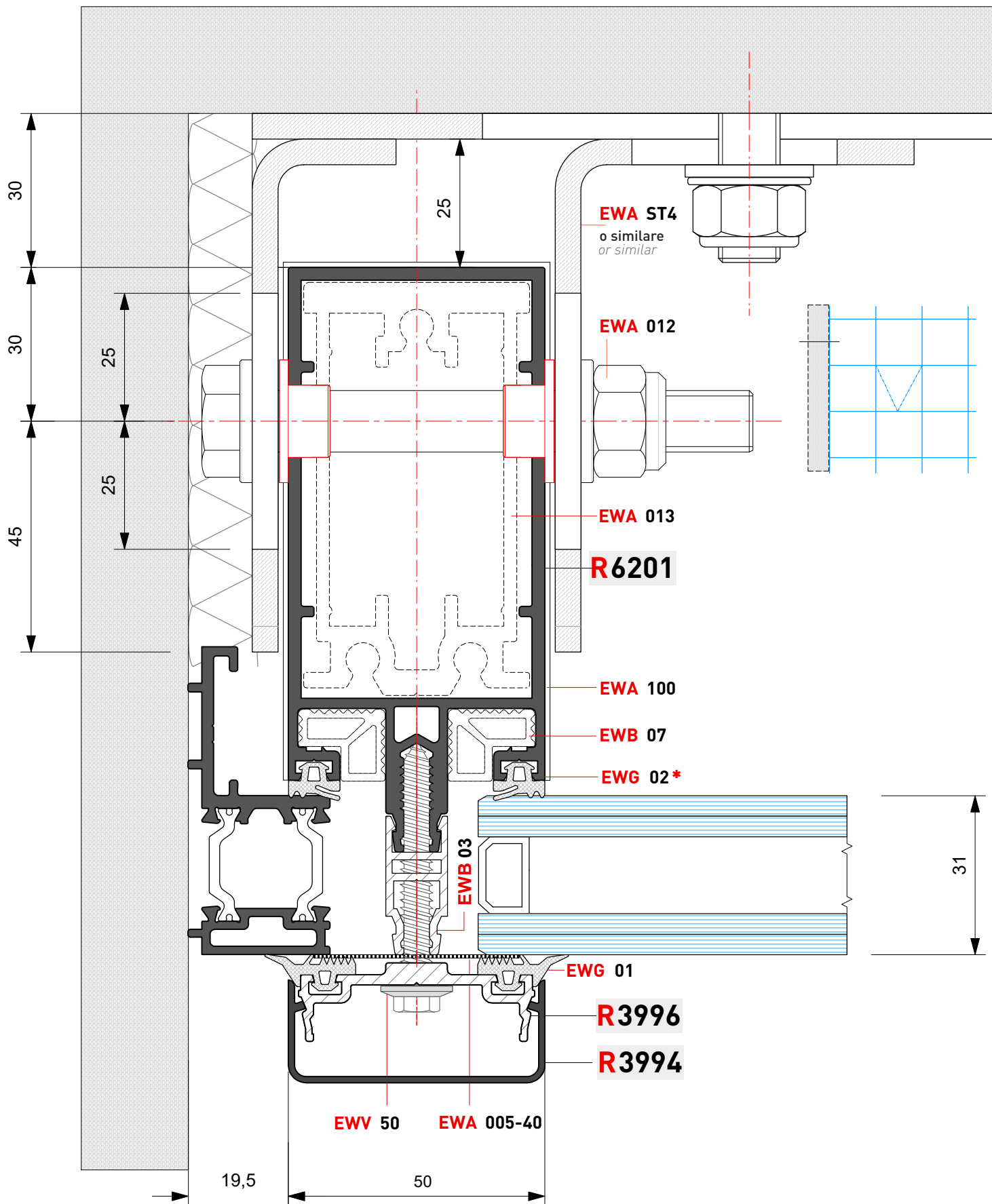

***NB: Solo con EWA.021 | Only with EWA.021**



Evolution

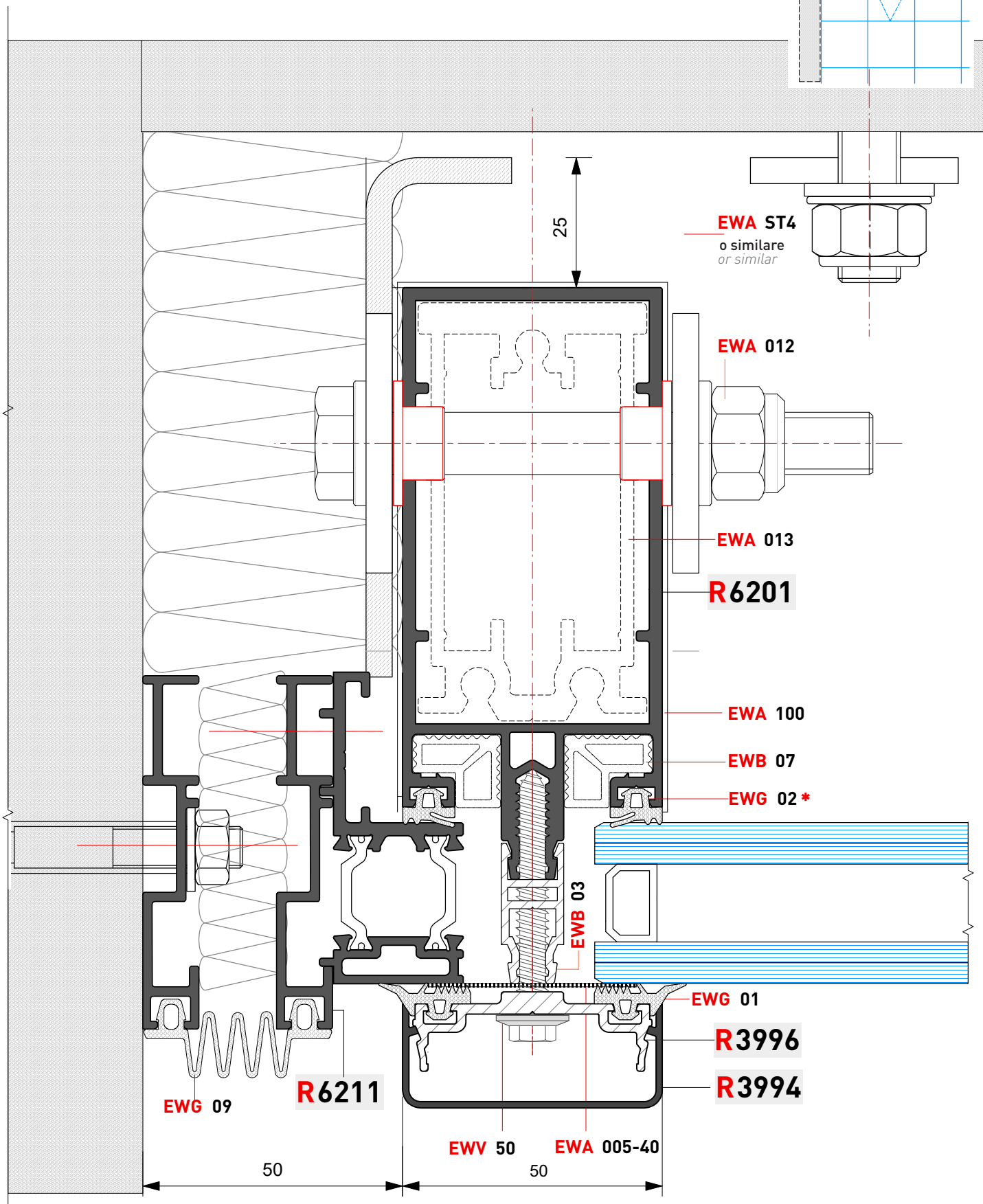

***NB: Solo con EWA.021 | Only with EWA.021**



Evolution

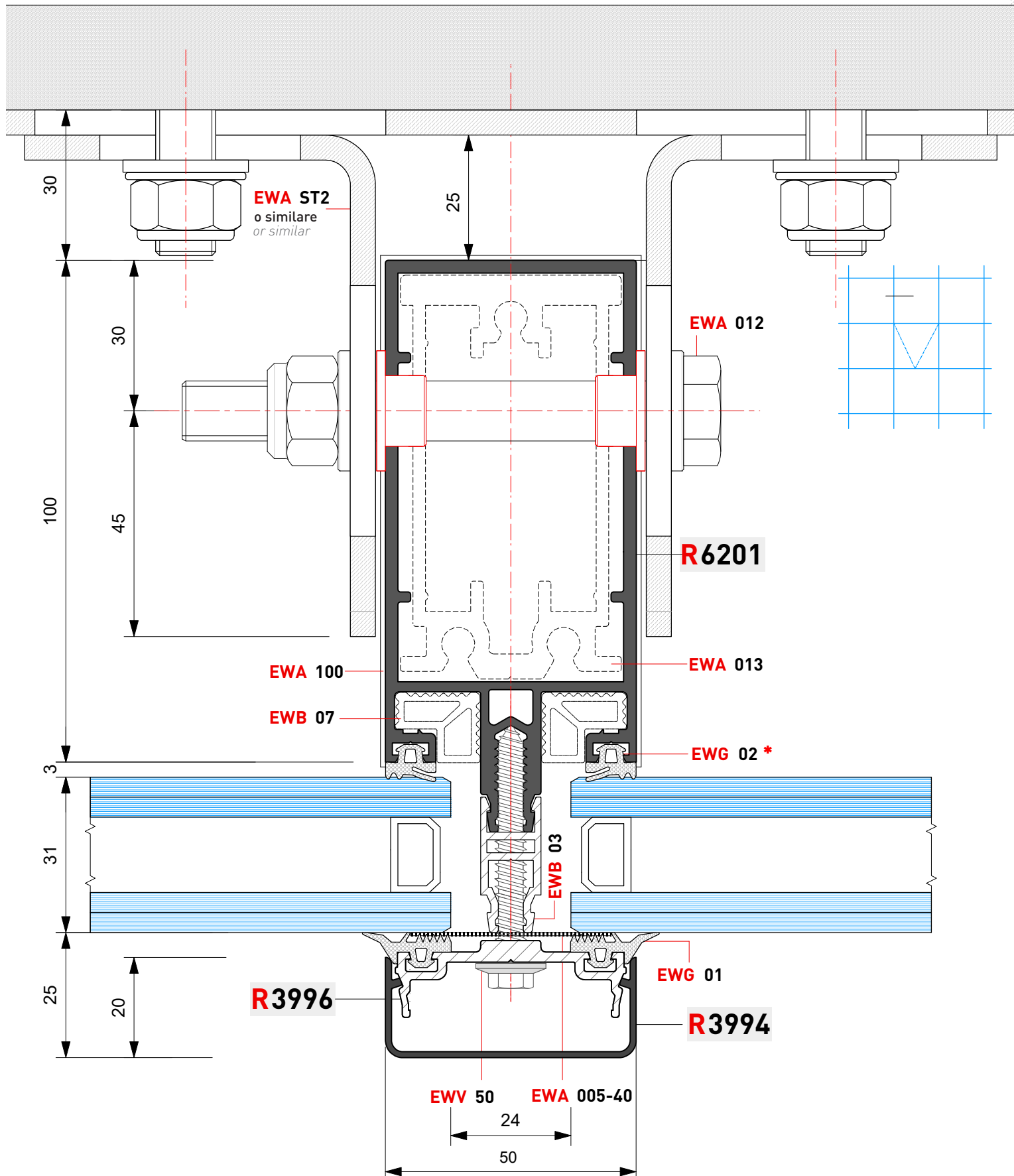

***NB: Solo con EWA.021 | Only with EWA.021**



Evolution

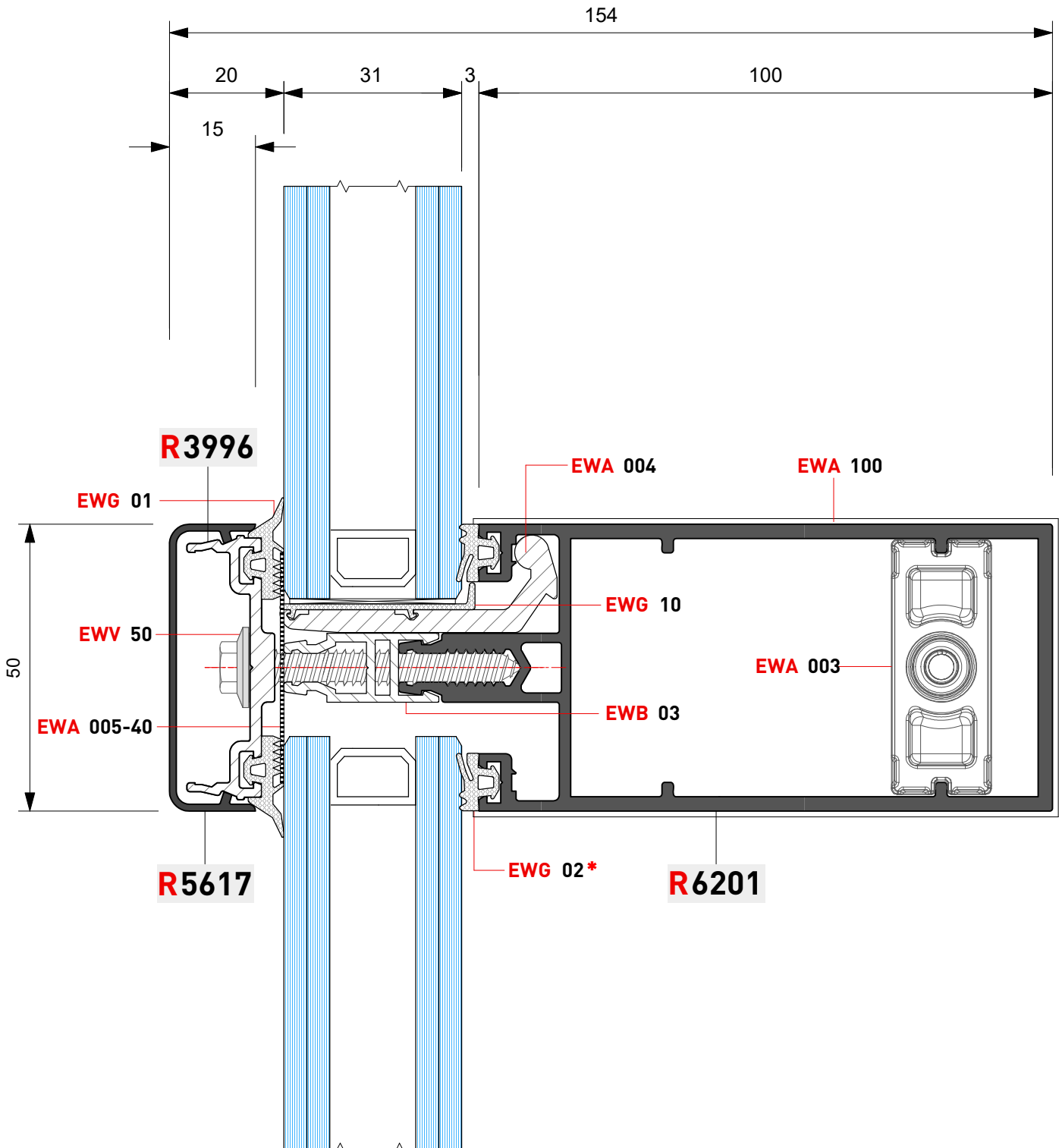
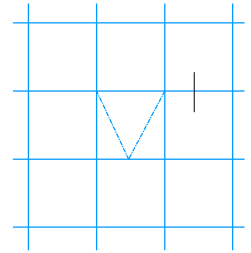

***NB: Solo con EWA.021 | Only with EWA.021**



Evolution

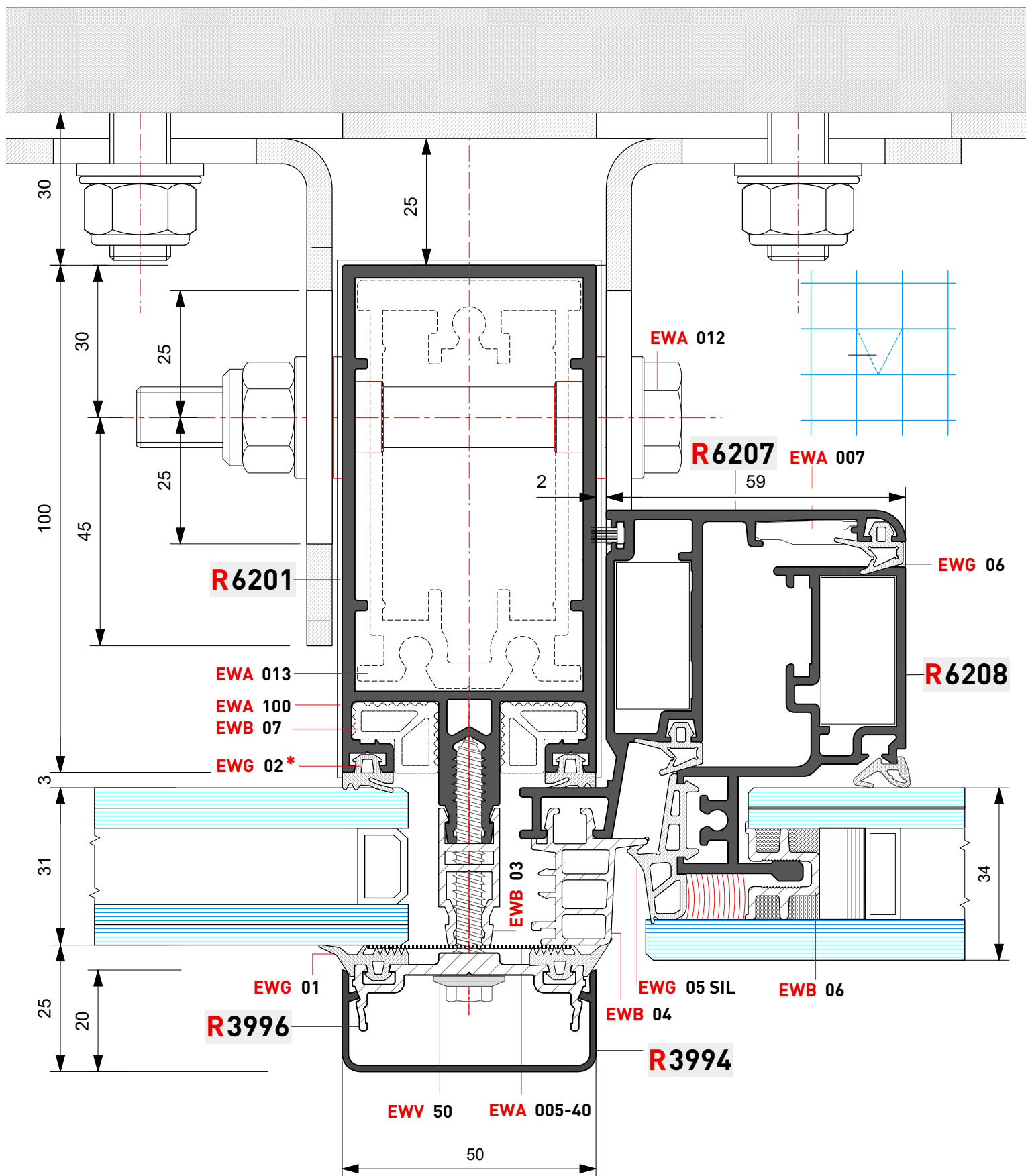

***NB: Solo con EWA.021 | Only with EWA.021**



Evolution

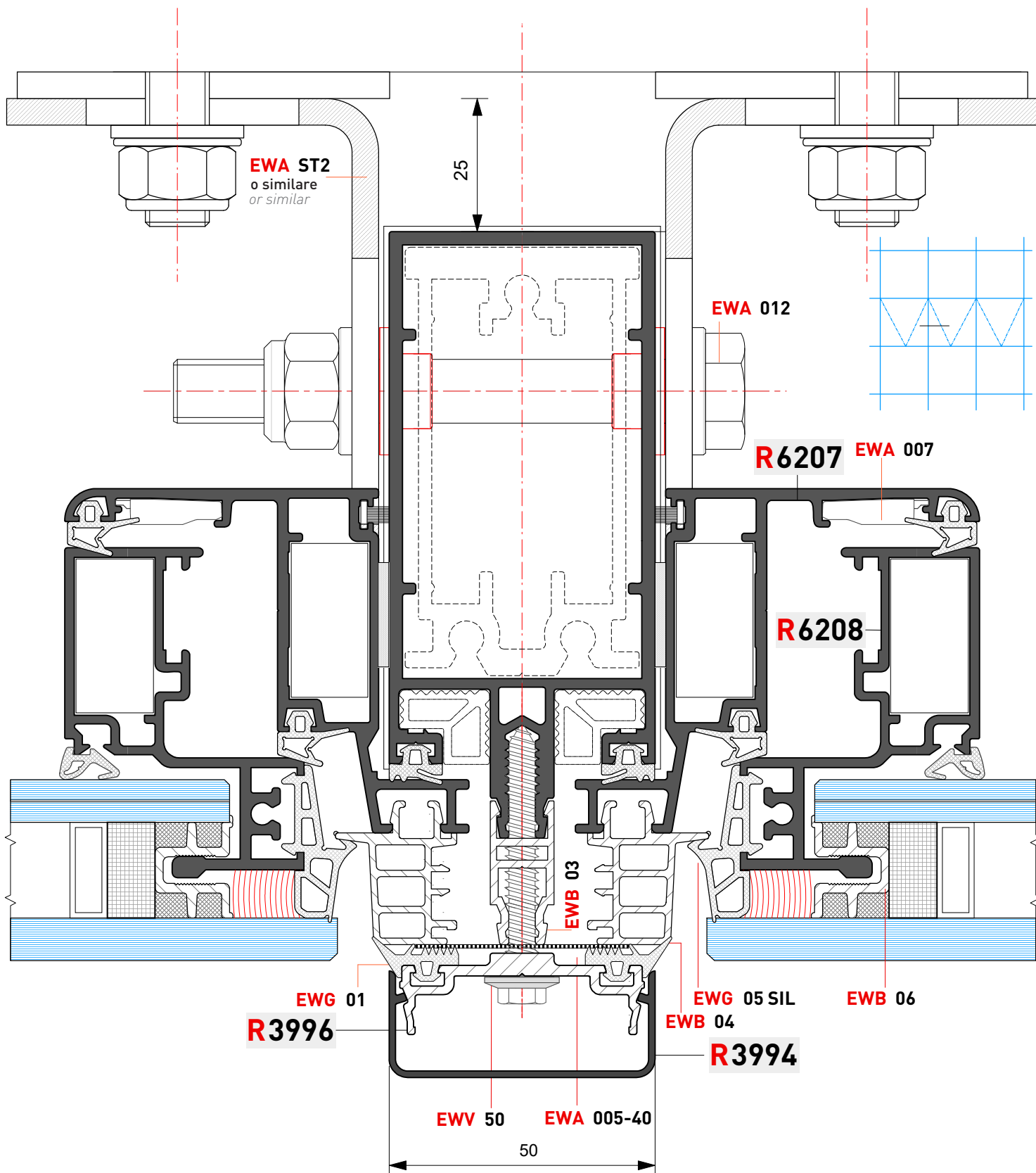



Evolution

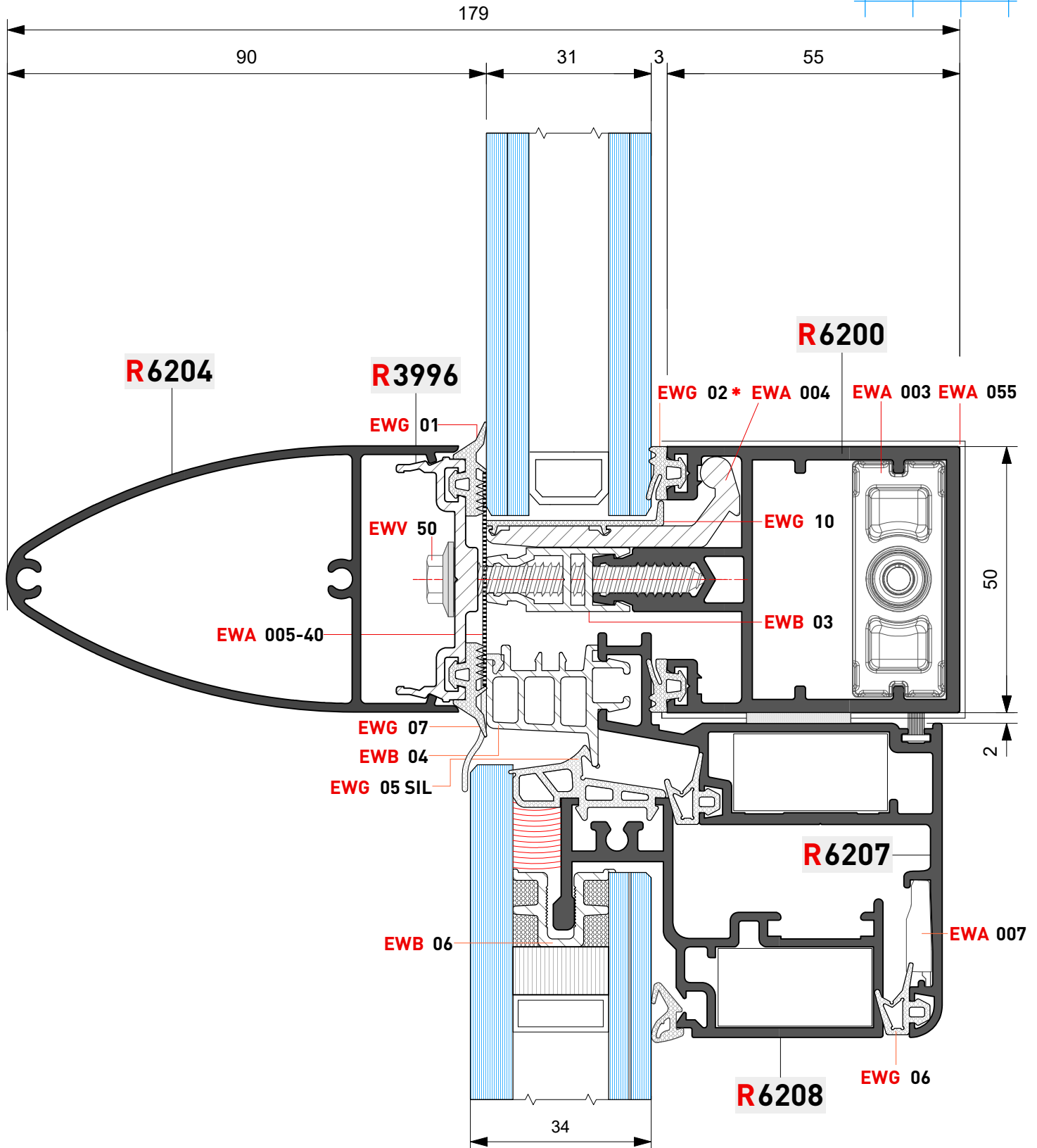
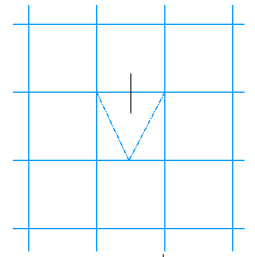

***NB: Solo con EWA.021 | Only with EWA.021**



Evolution

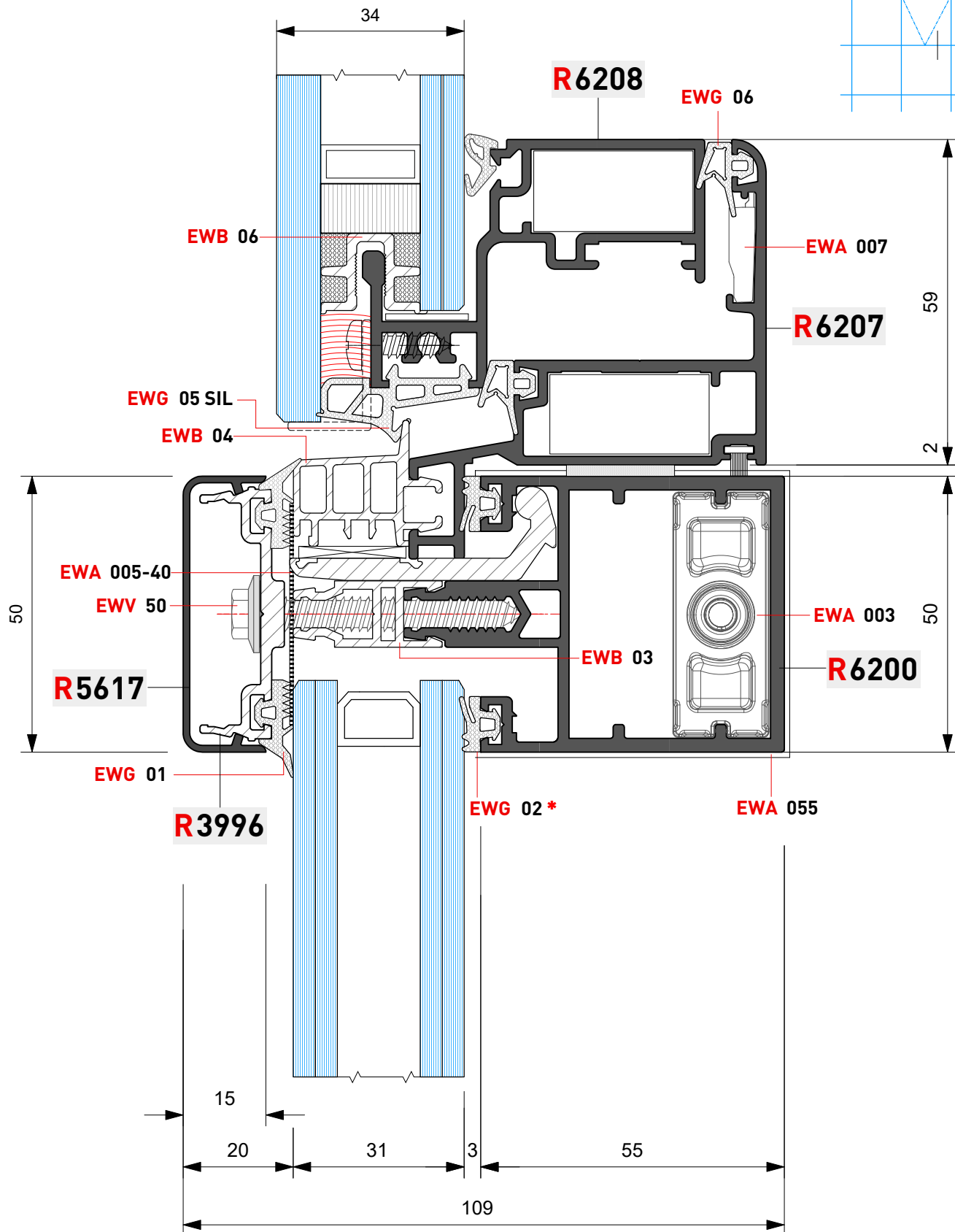
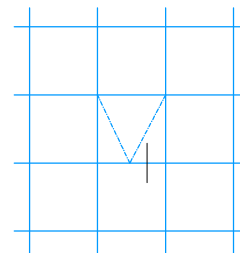

***NB: Solo con EWA.021 | Only with EWA.021**



Evolution

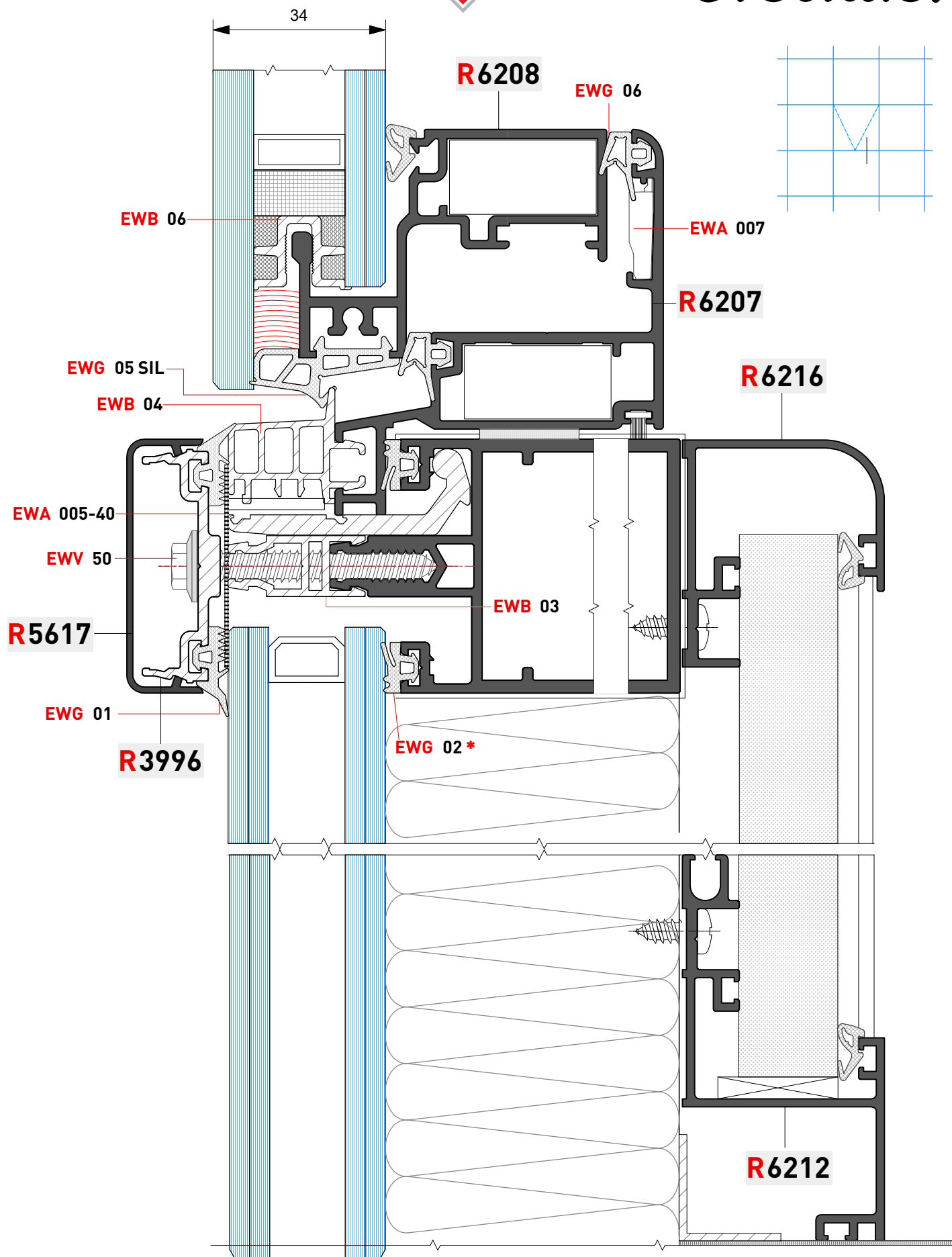

***NB: Solo con EWA.021 | Only with EWA.021**

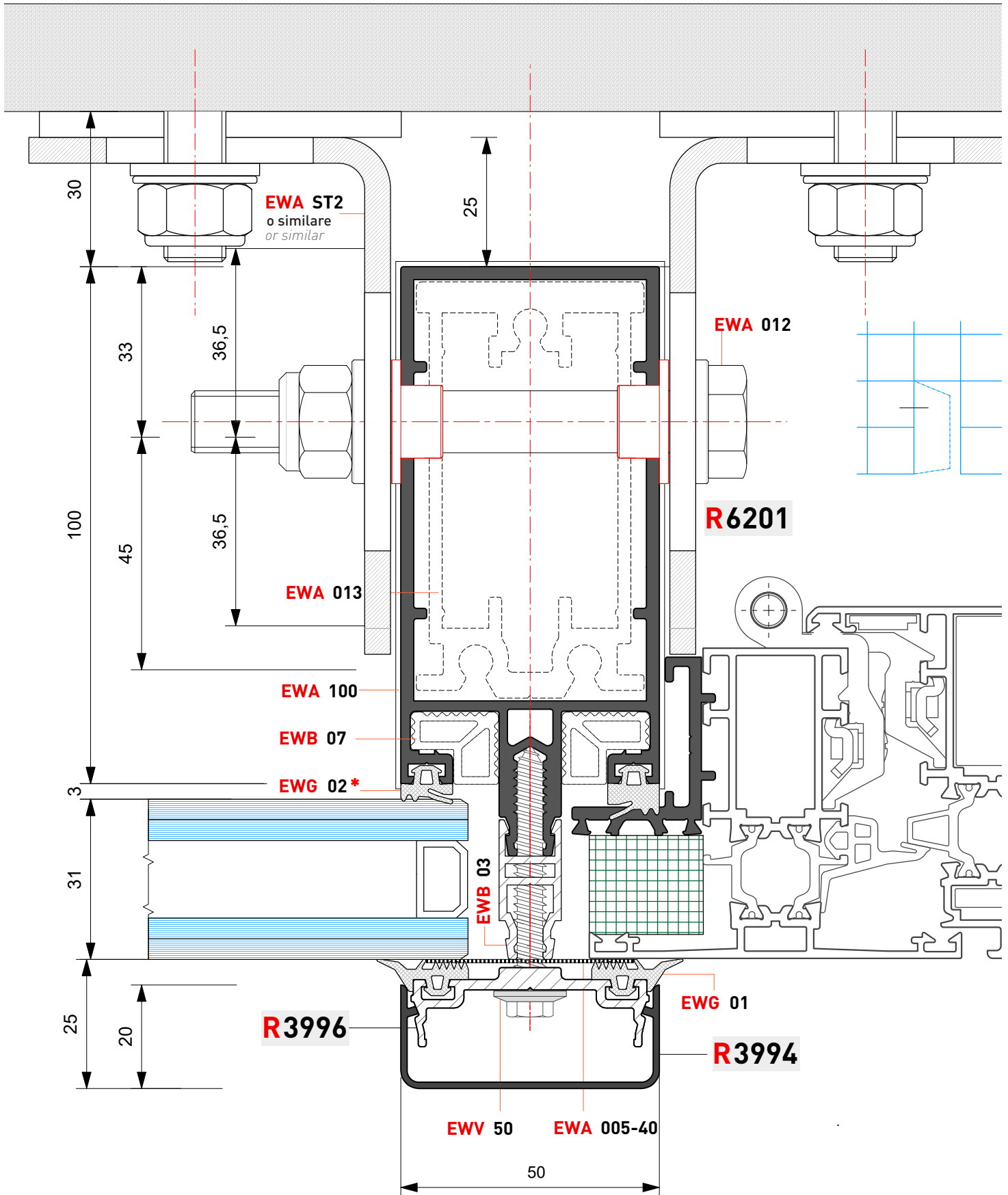

***NB: Solo con EWA.021 | Only with EWA.021**



Evolution

Soluzione senza pressione verticale
Solution without vertical presser

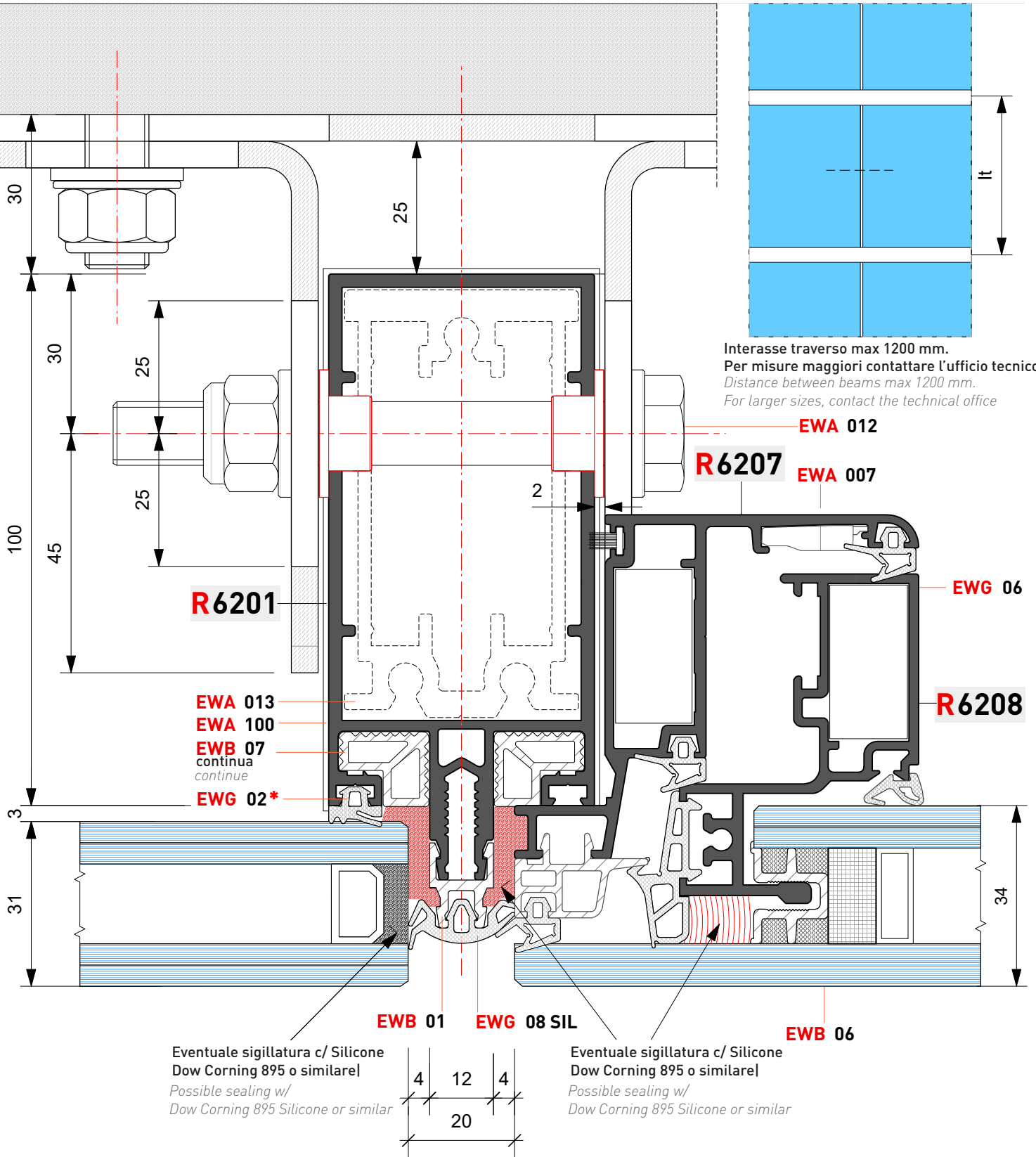

***NB: Solo con EWA.021 | Only with EWA.021**



Evolution

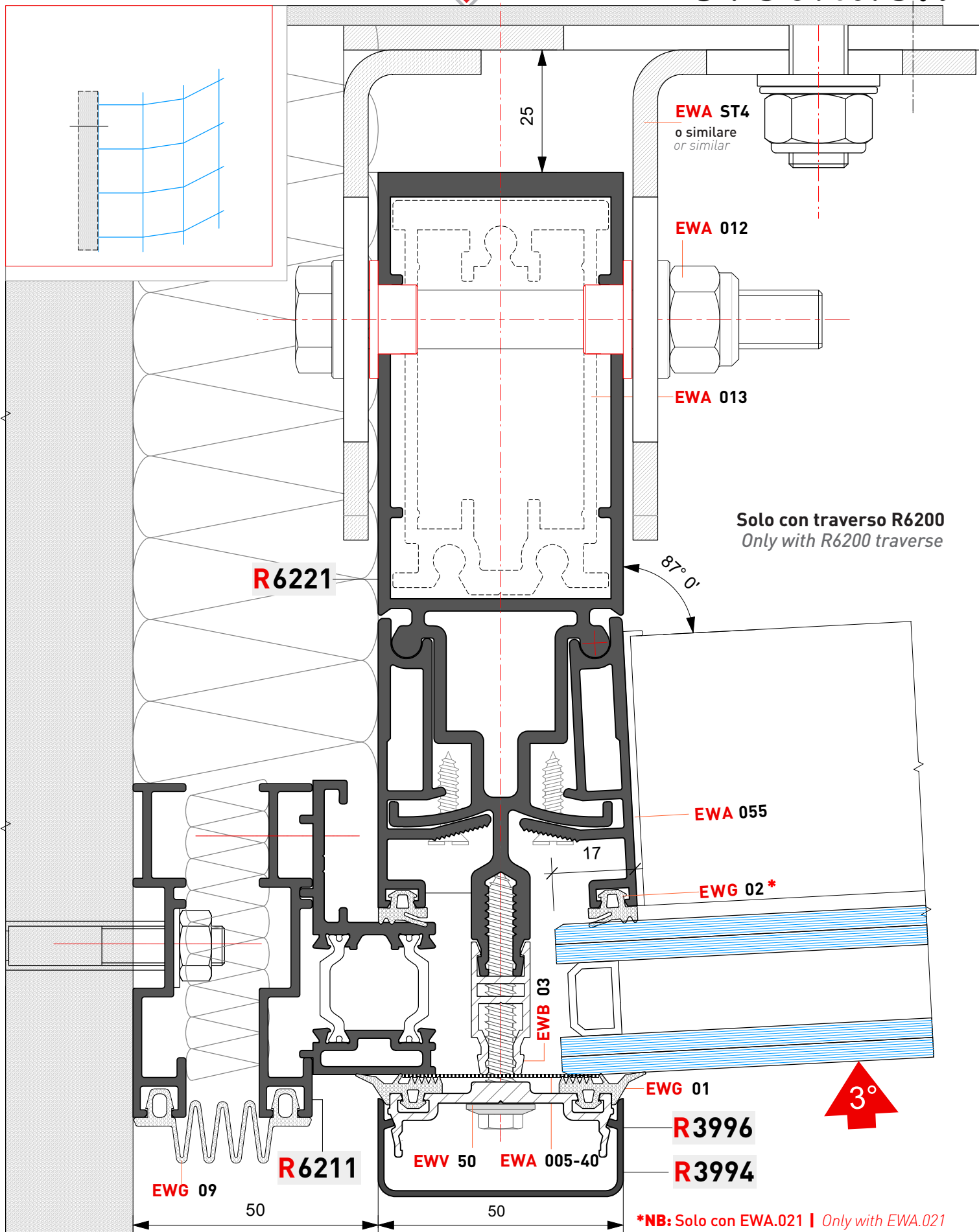



Evolution

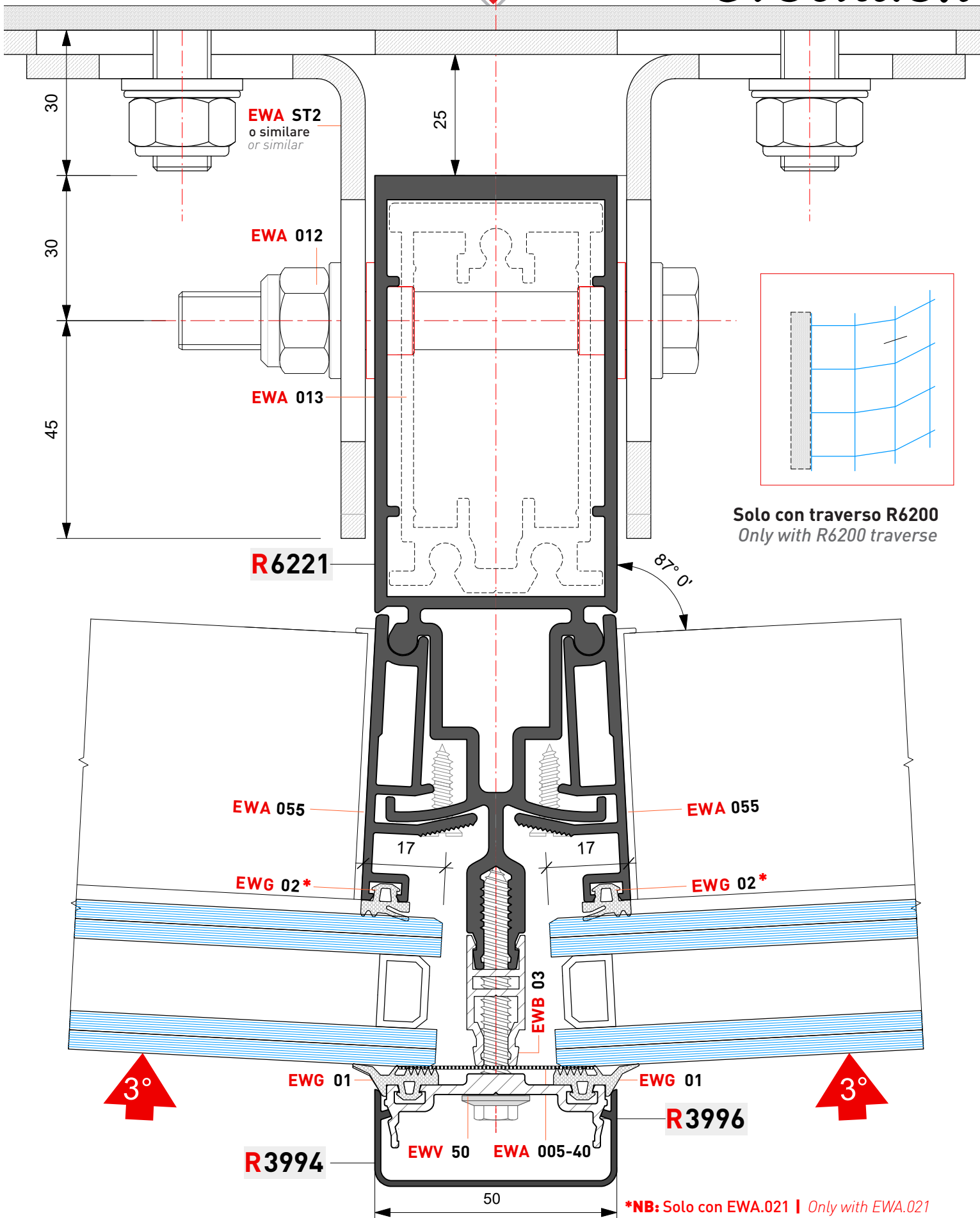

Evolution

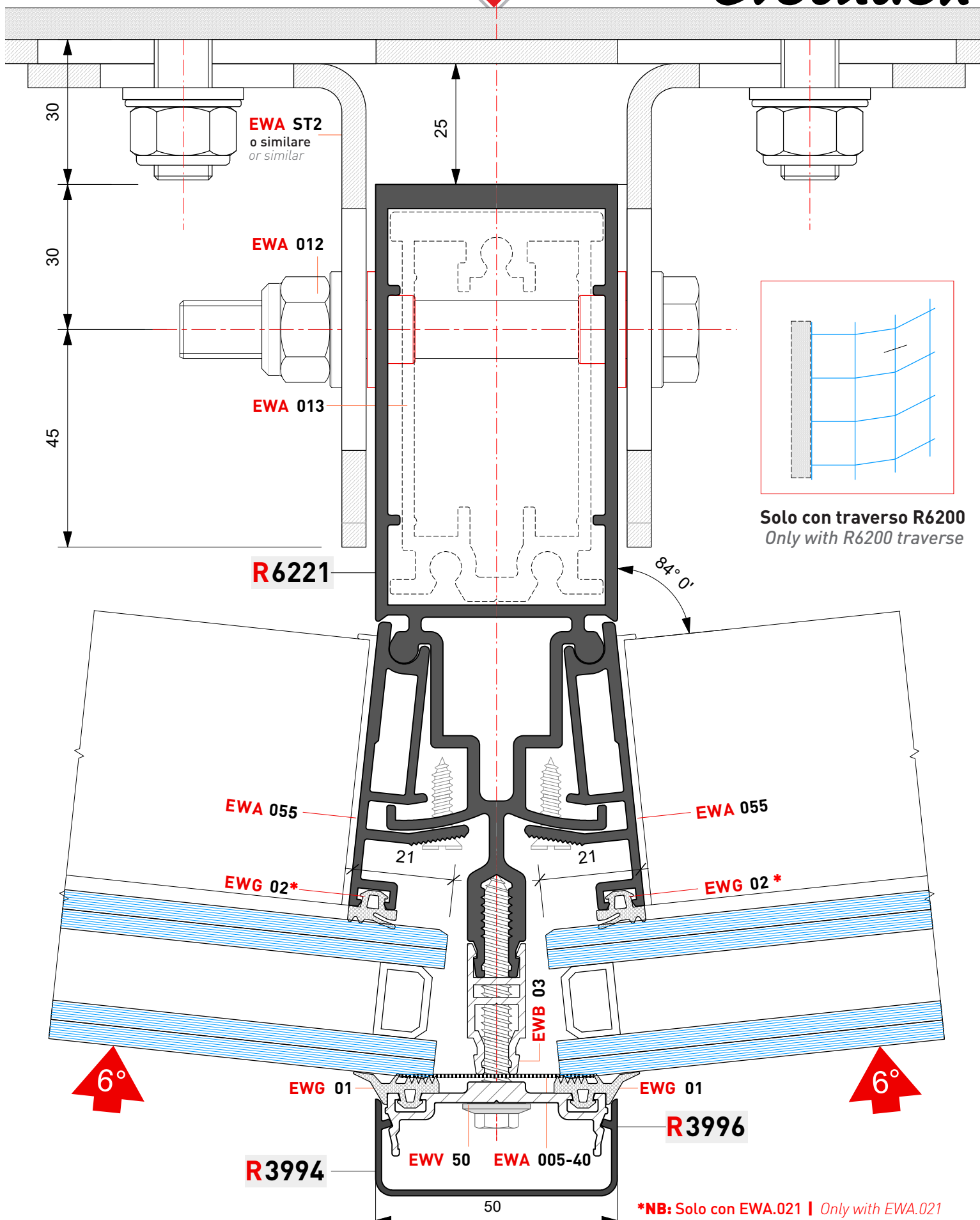

Evolution

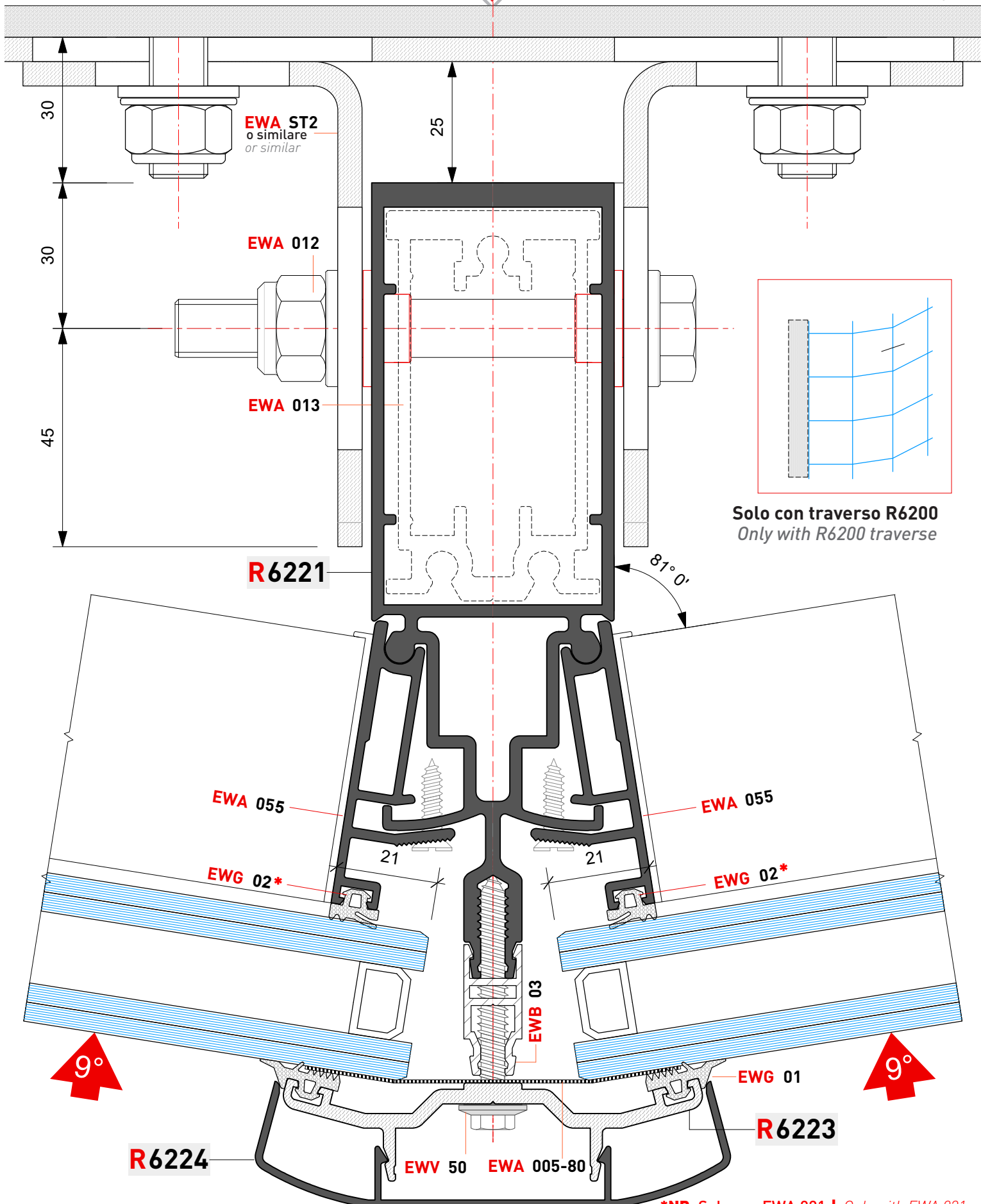

***NB: Solo con EWA.021 | Only with EWA.021**

Evolution

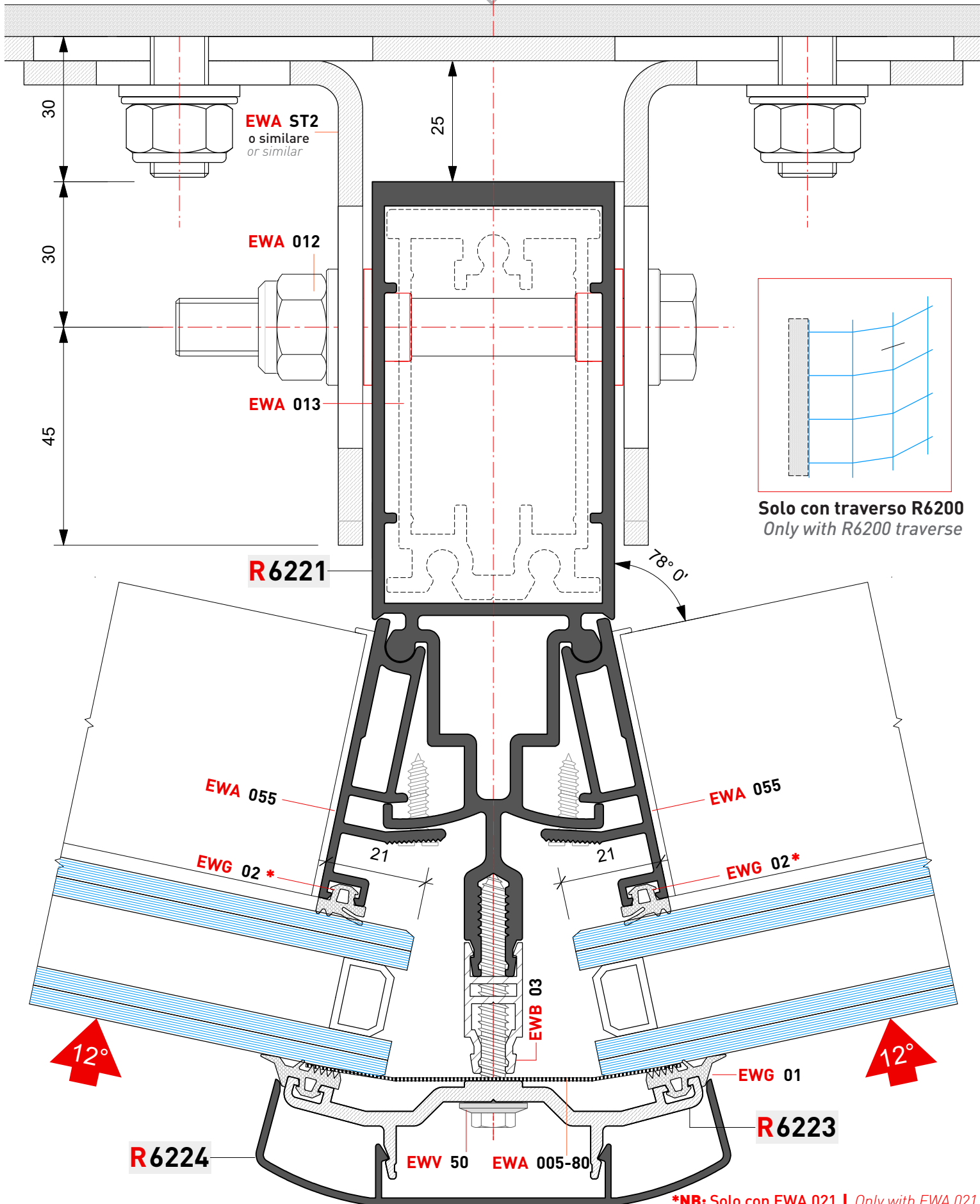

***NB: Solo con EWA.021 | Only with EWA.021**

Evolution

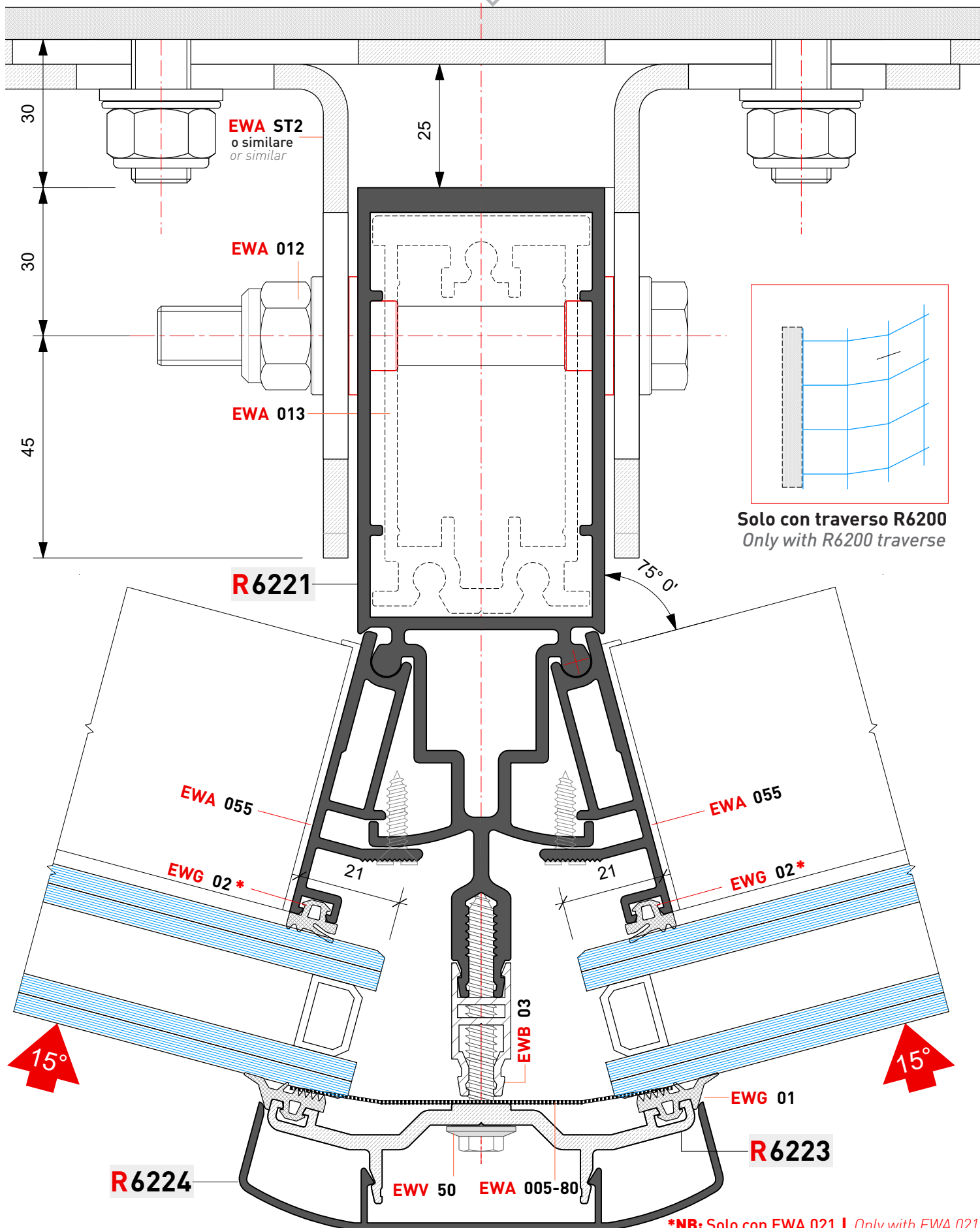

***NB: Solo con EWA.021 | Only with EWA.021**

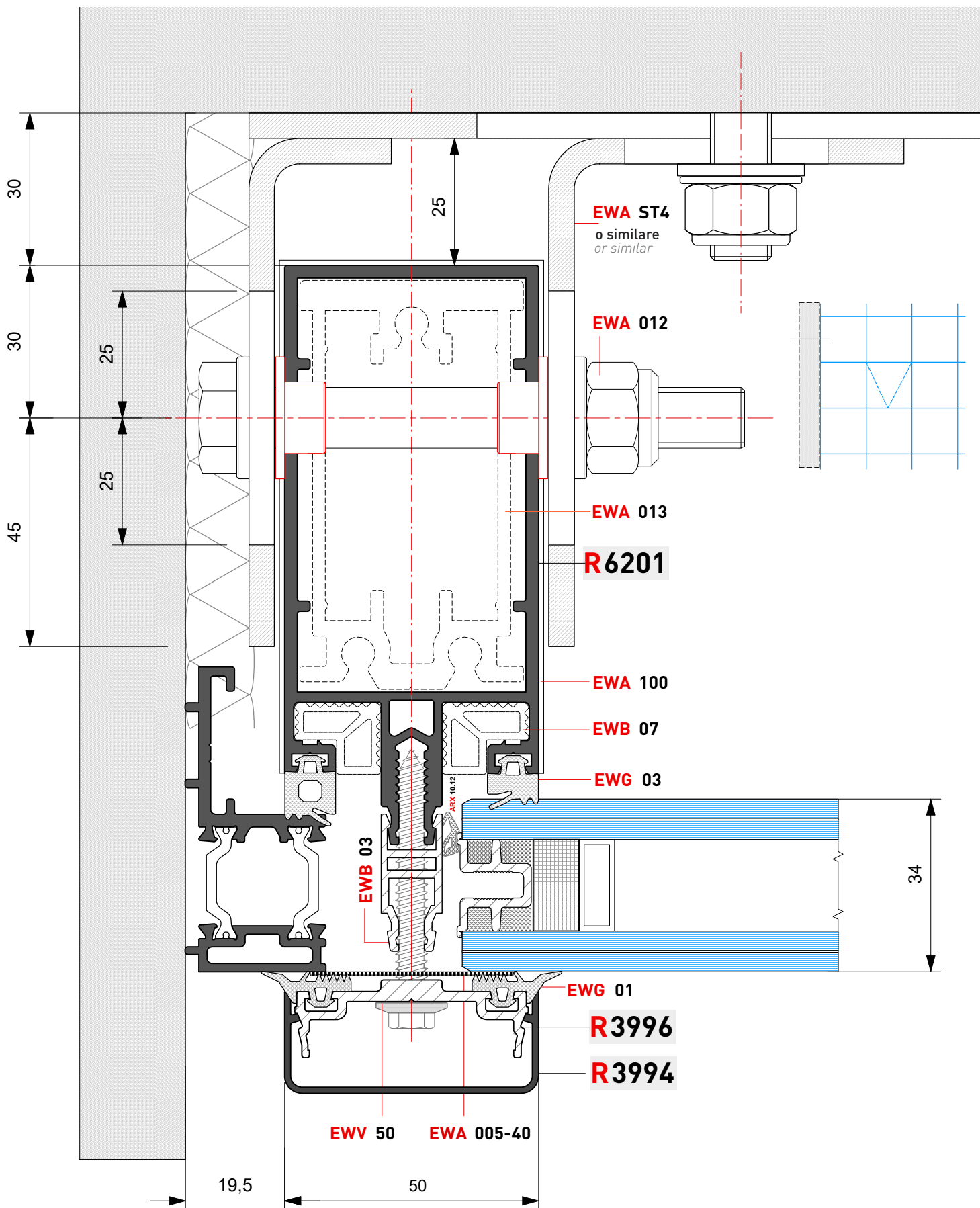



Evolution

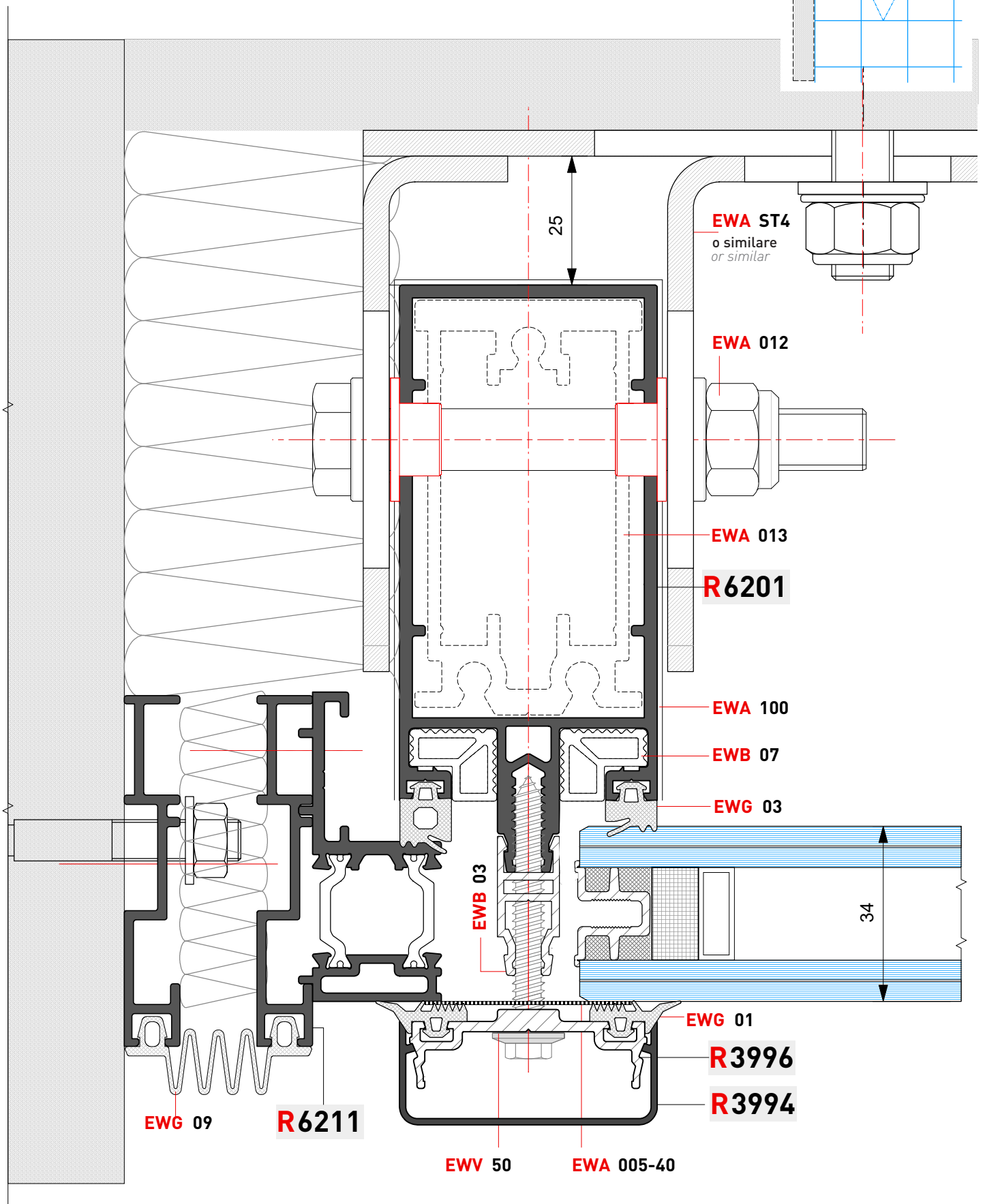

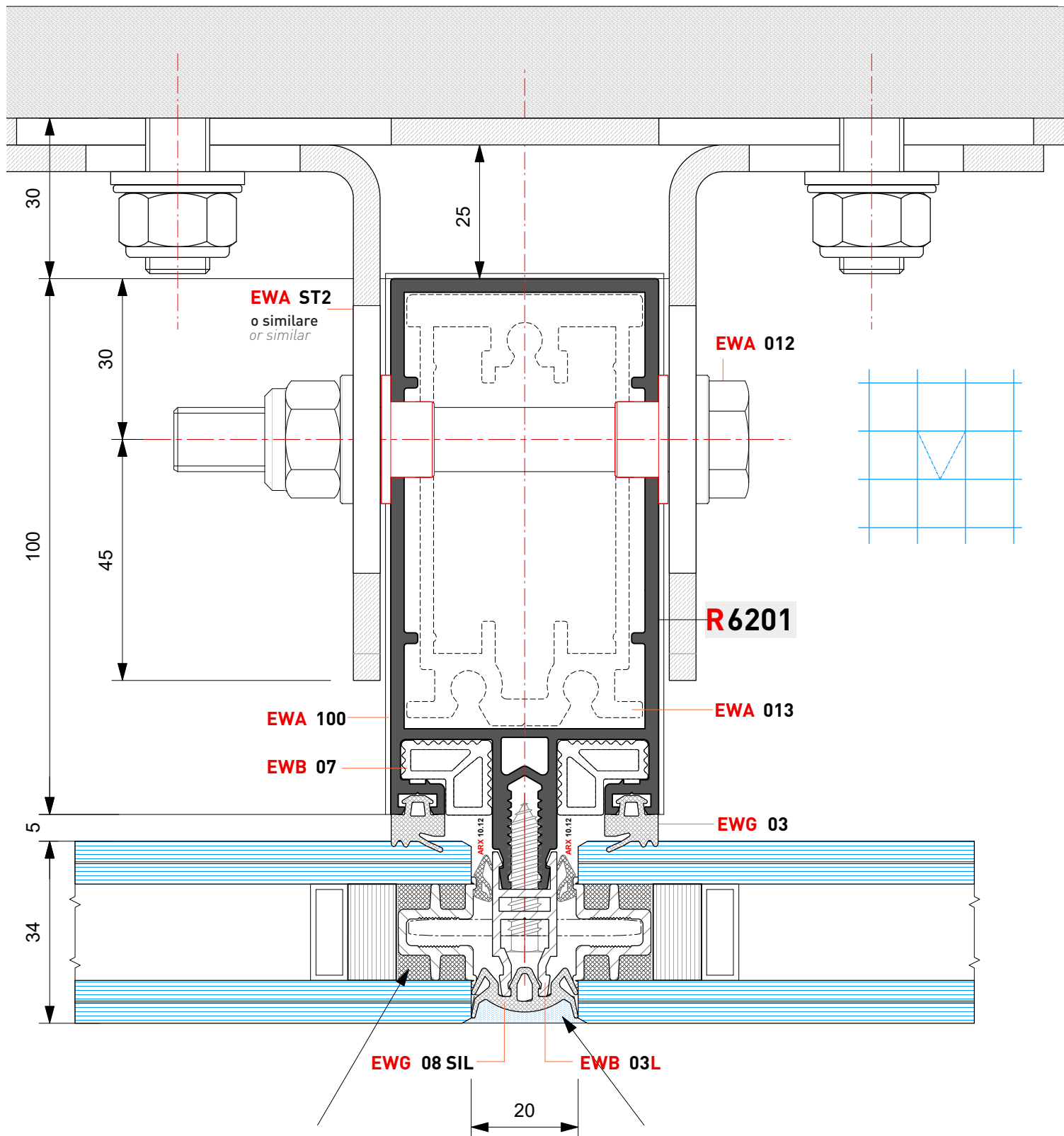

Eventuale sigillatura c/ Silicone
Dow Corning 895 o similare|
*Possible sealing w/
Dow Corning 895 Silicone or similar*

Eventuale sigillatura c/ Silicone
Dow Corning 791 o similare|
*Possible sealing w/
Dow Corning 791 Silicone or similar*

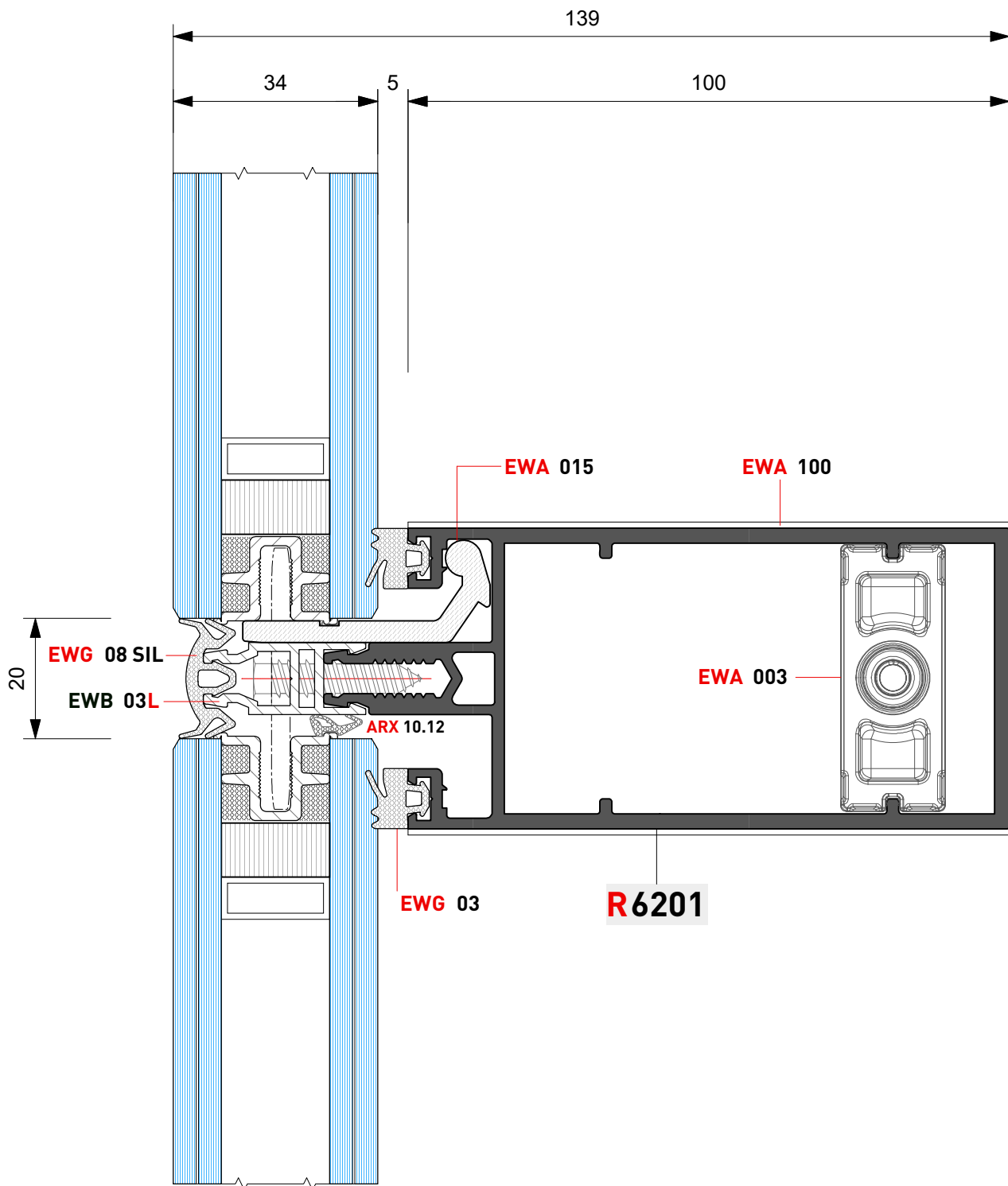
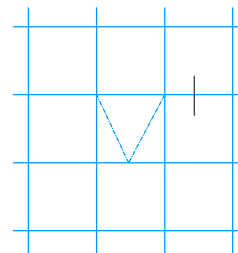

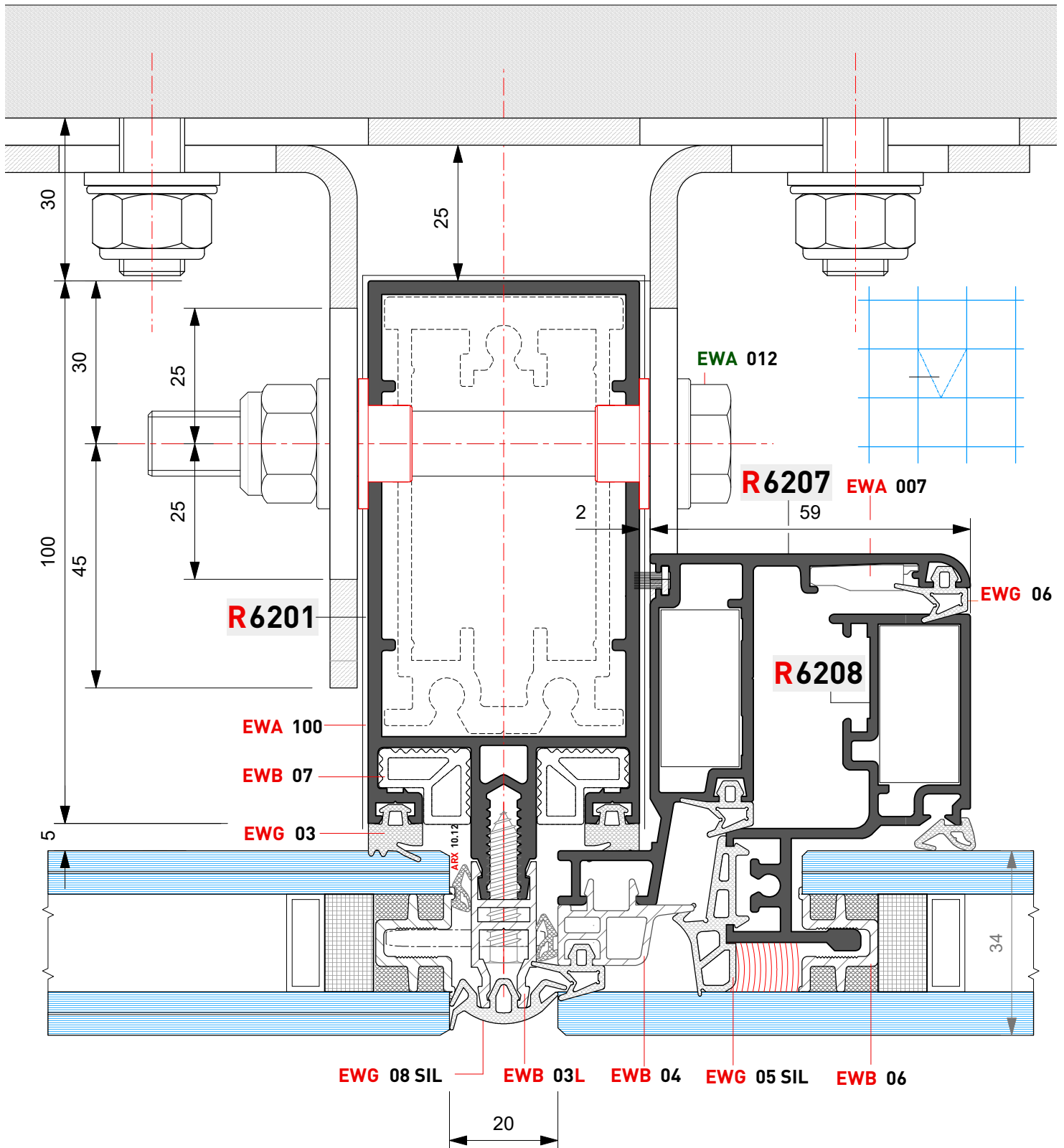

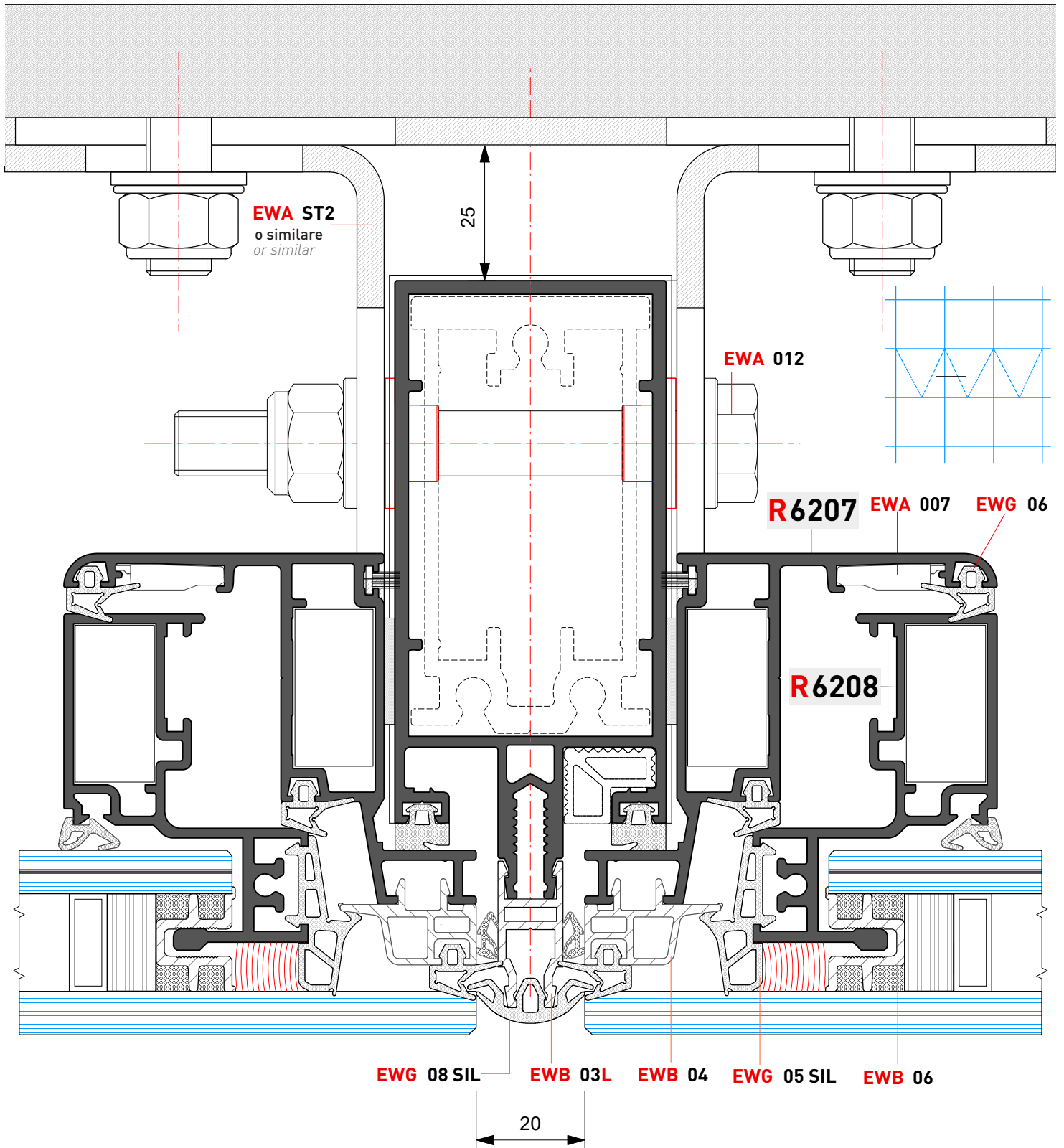

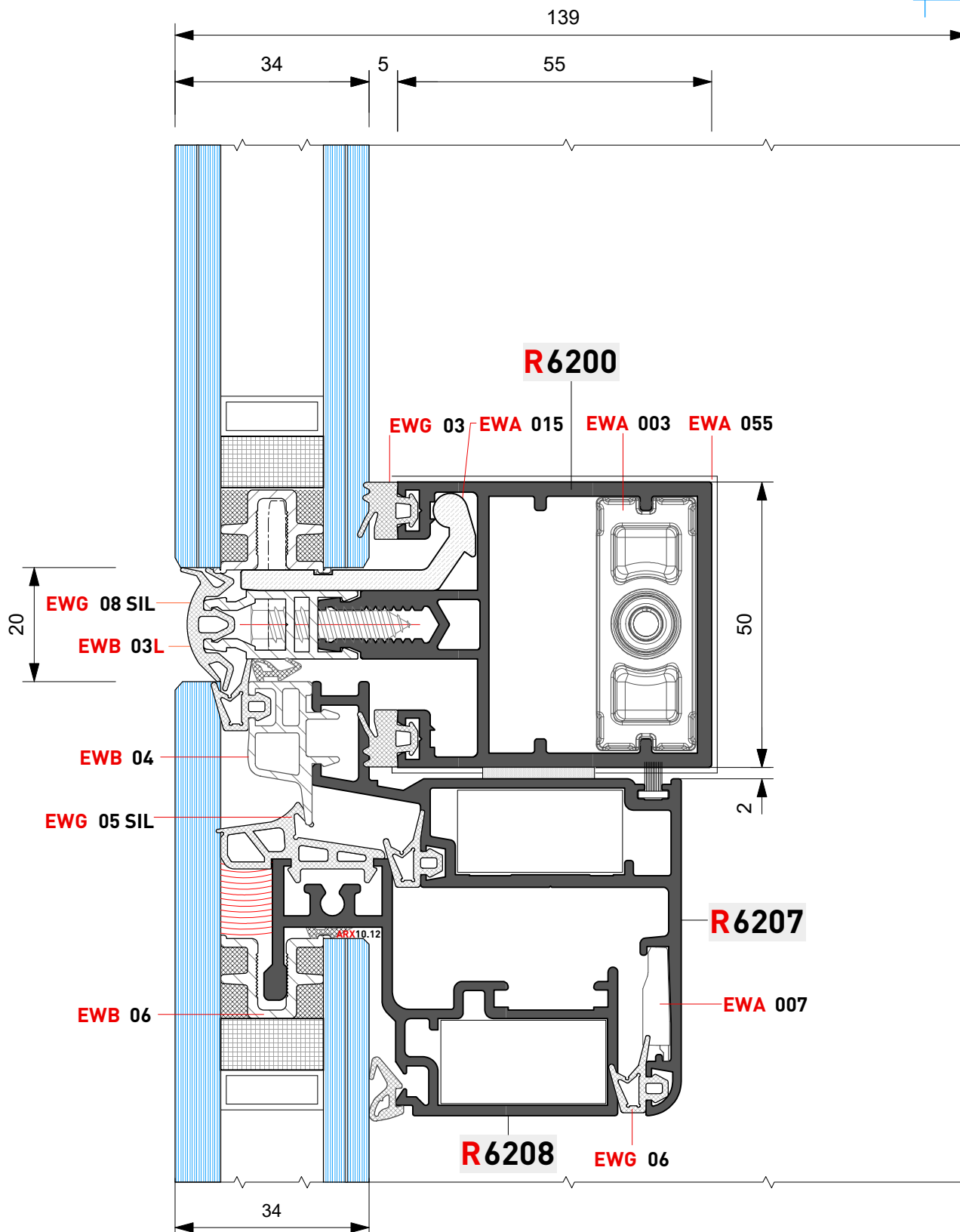
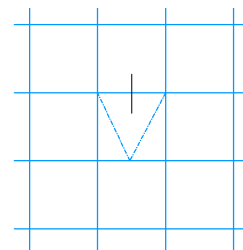

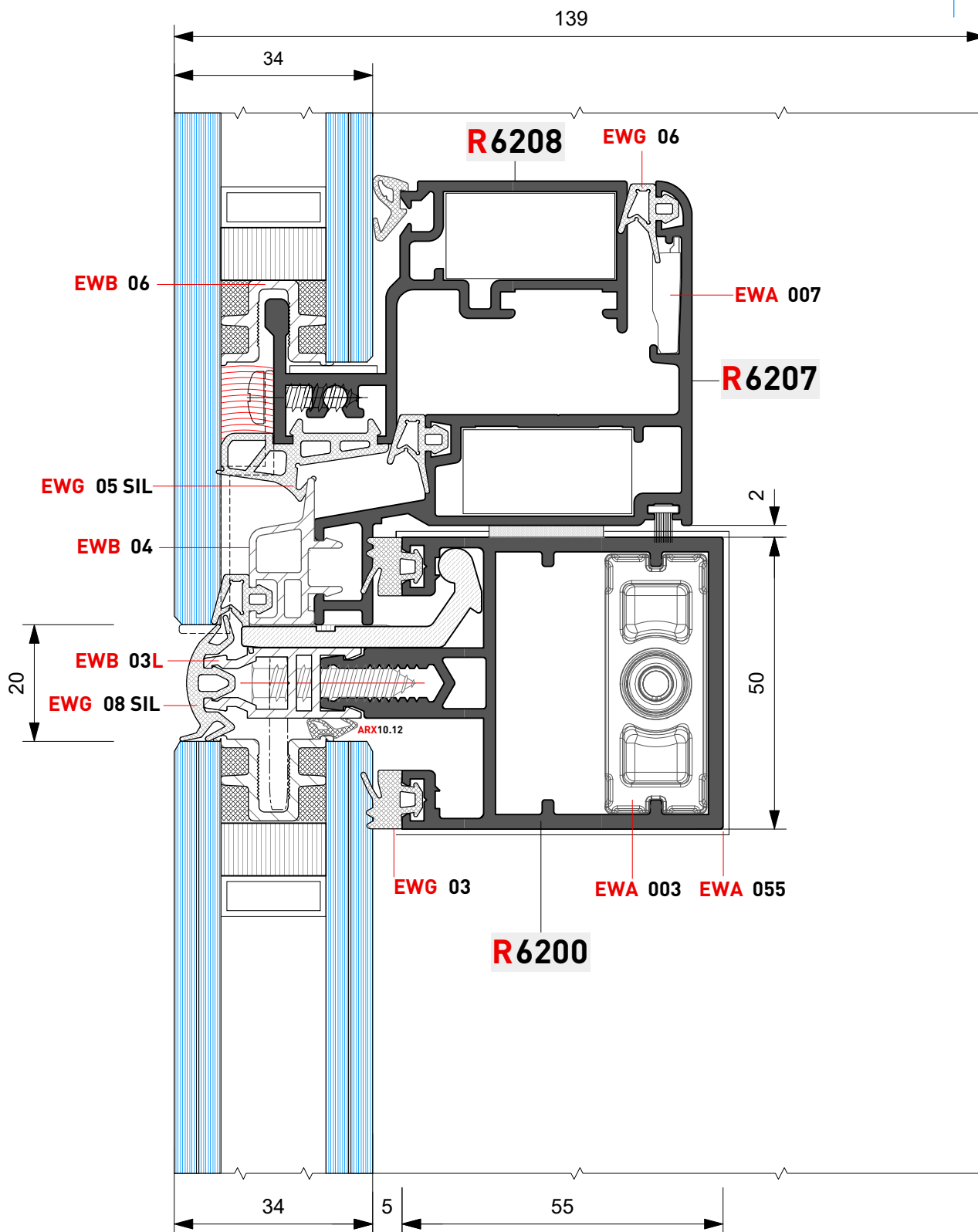
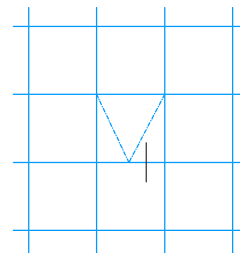

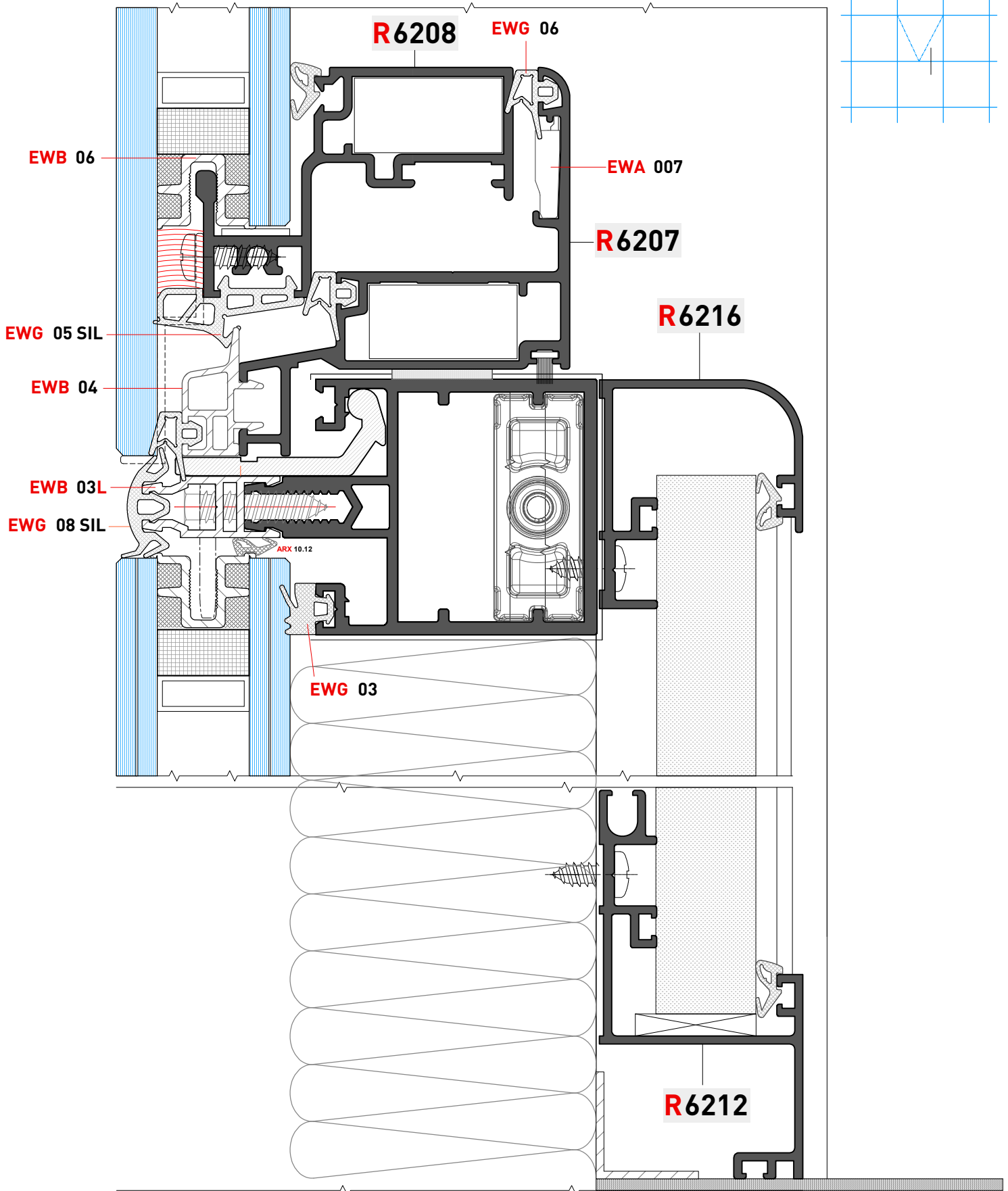



Evolution

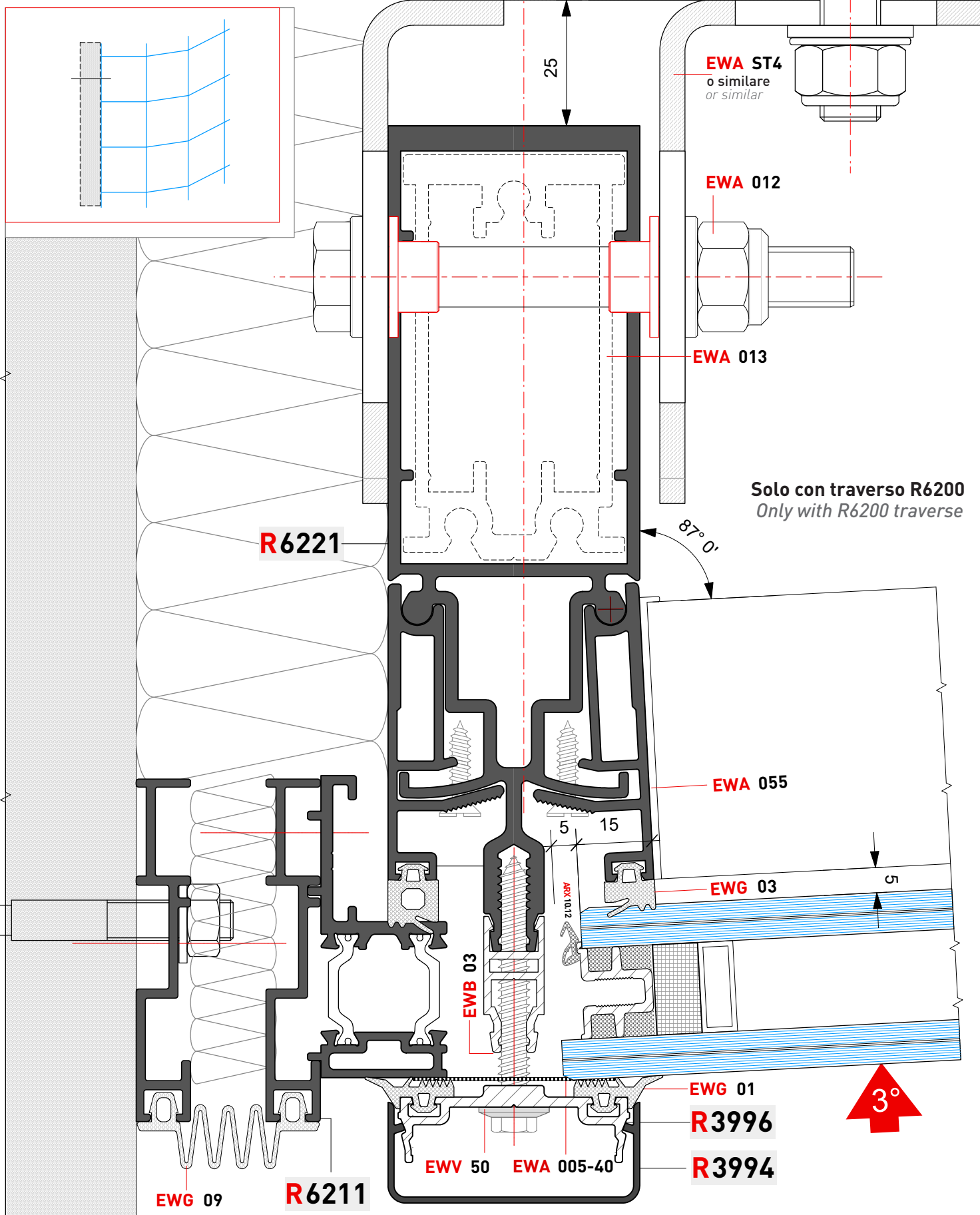



Evolution GLASS

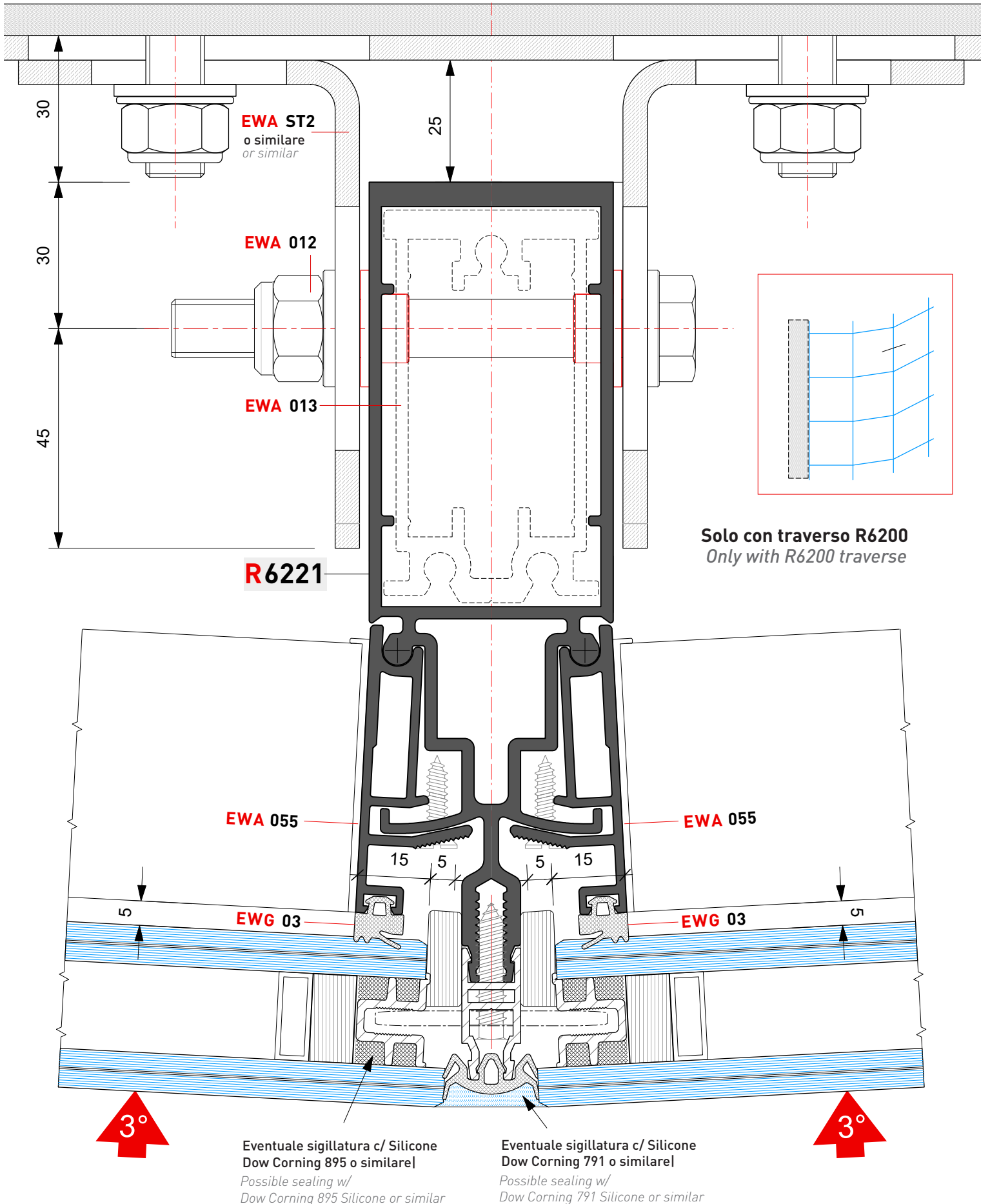

Solo con traverso R6200
Only with R6200 traverse



Eventuale sigillatura c/ Silicone
Dow Corning 895 o similare|
Possible sealing w/
Dow Corning 895 Silicone or similar



Eventuale sigillatura c/ Silicone
Dow Corning 791 o similare|
Possible sealing w/
Dow Corning 791 Silicone or similar

EvolutionGLASS

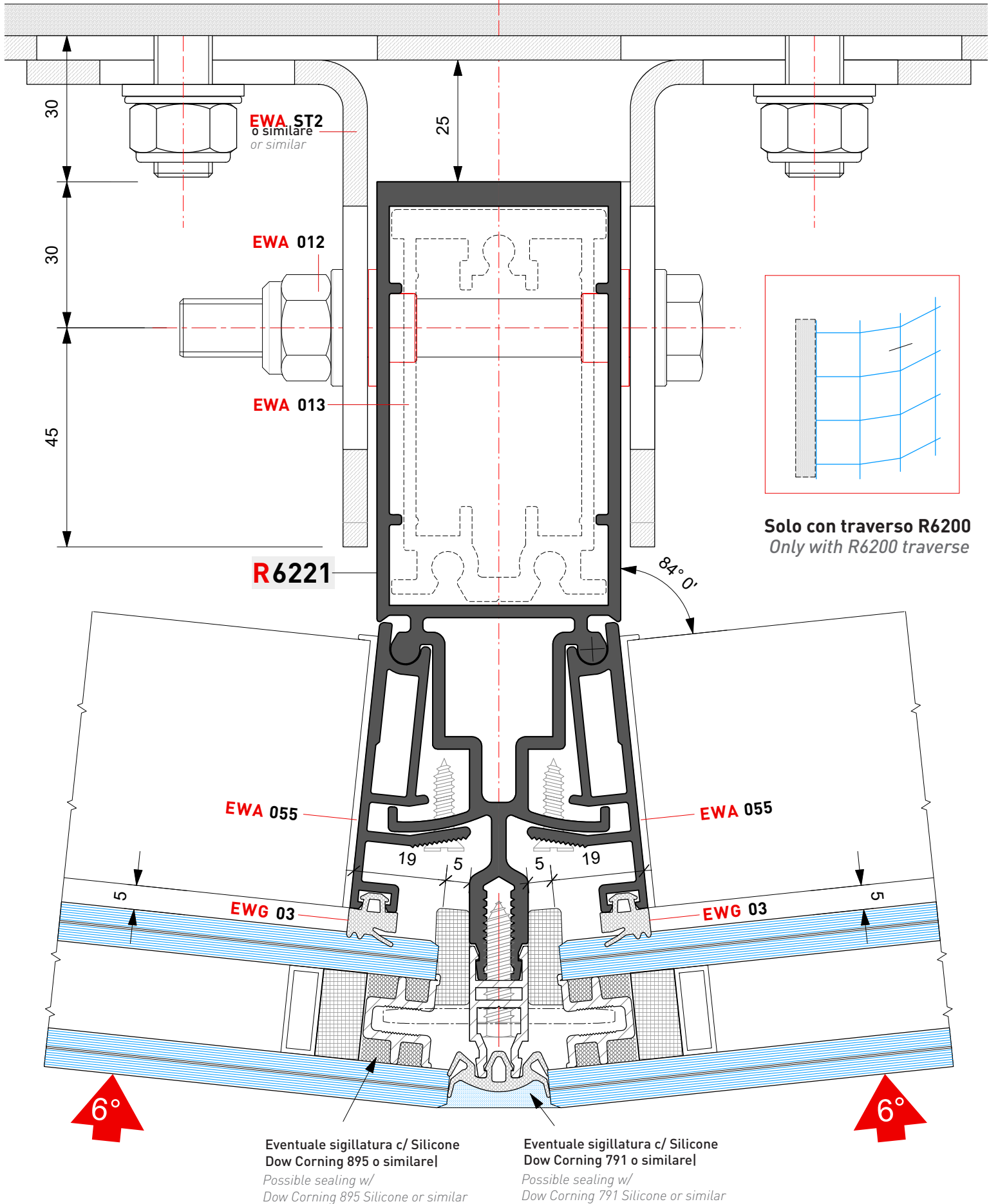

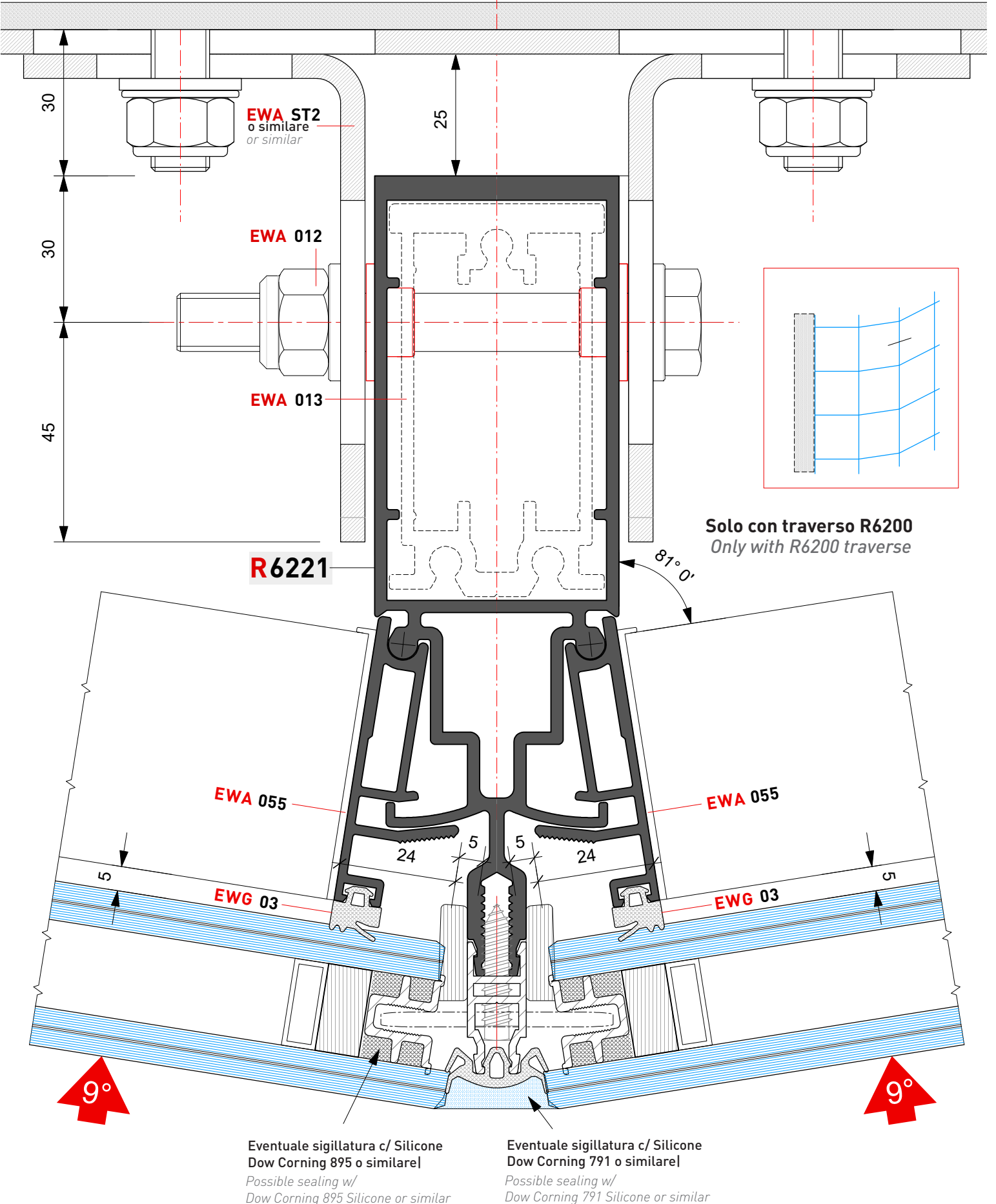

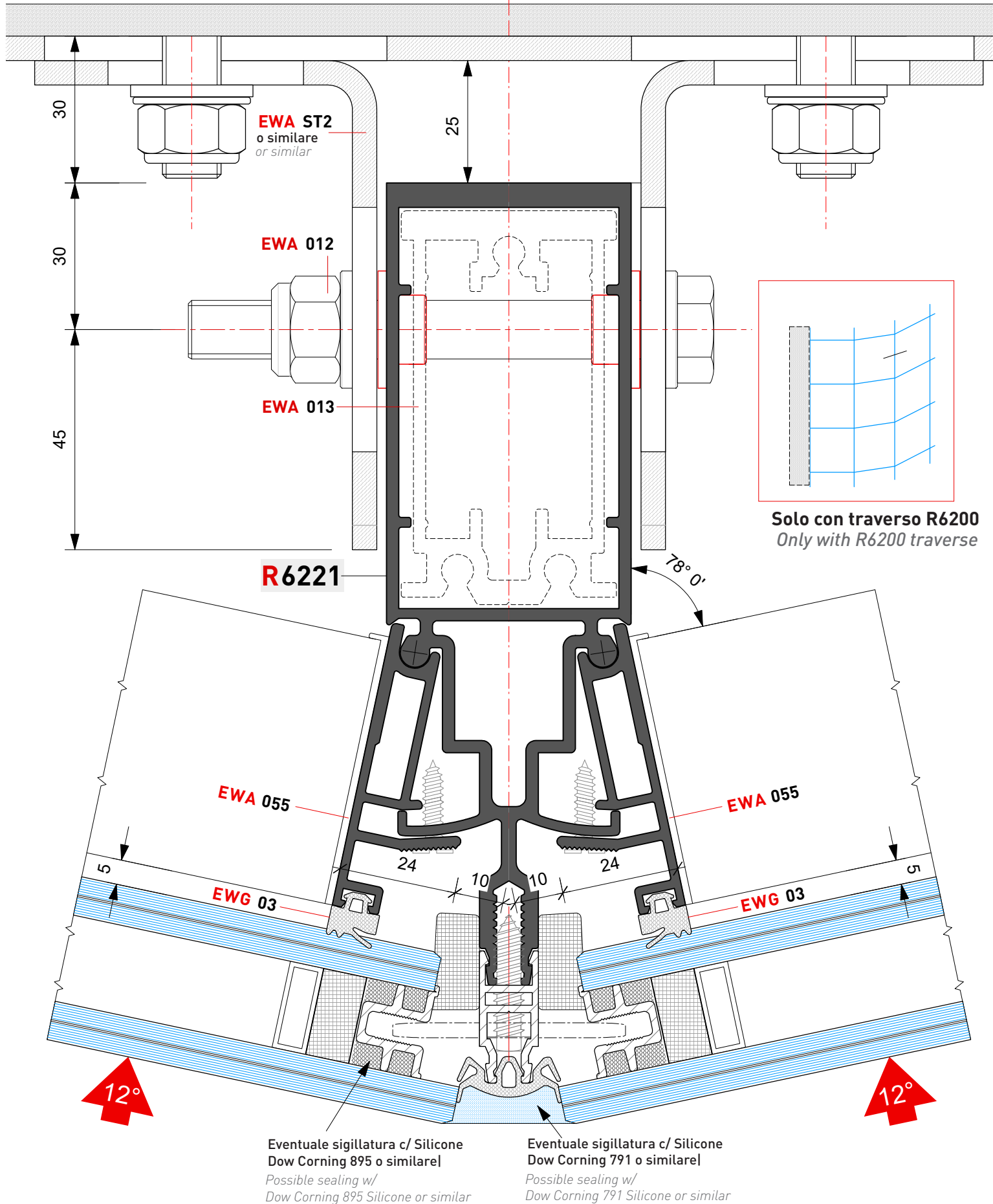

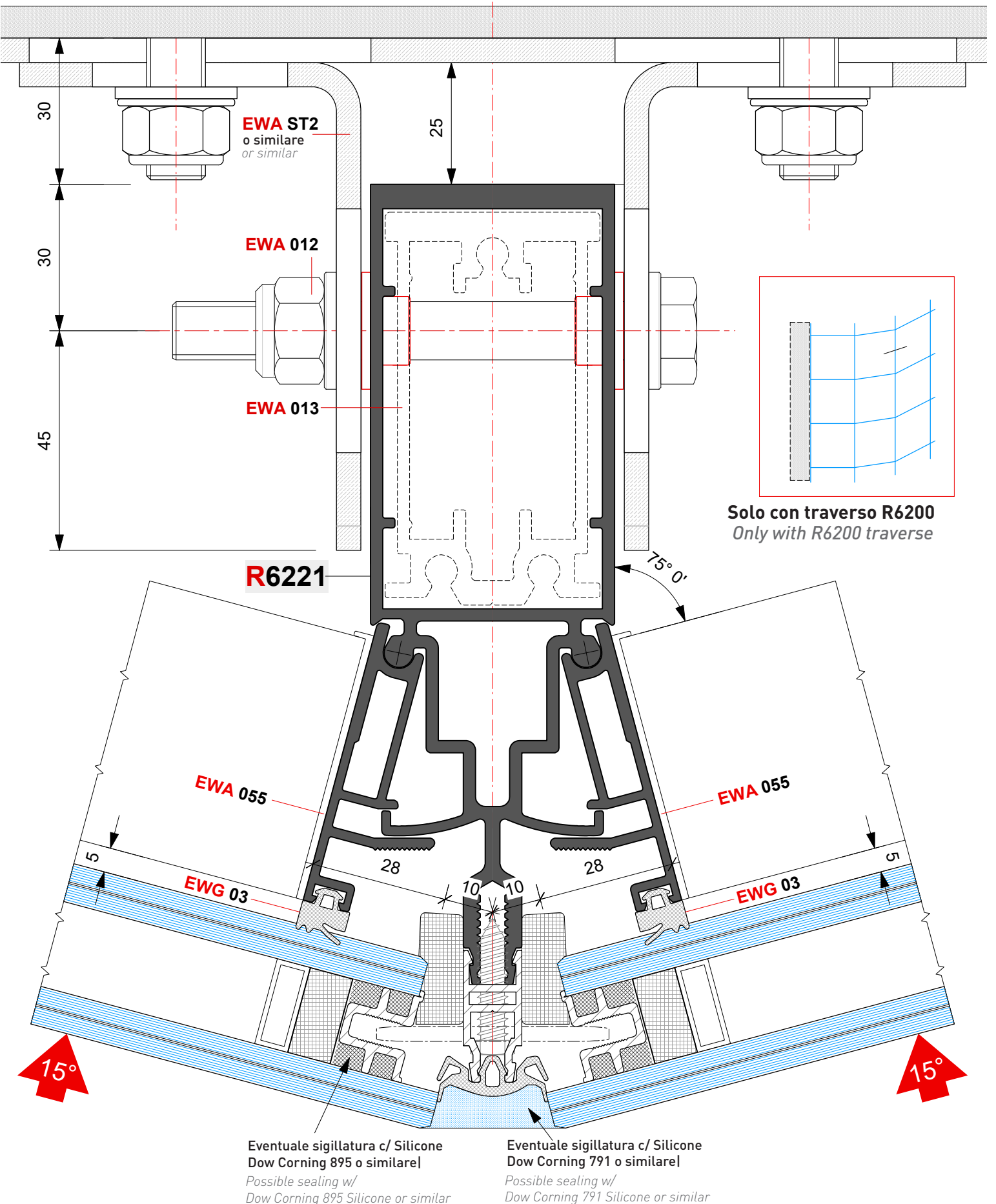



Evolution

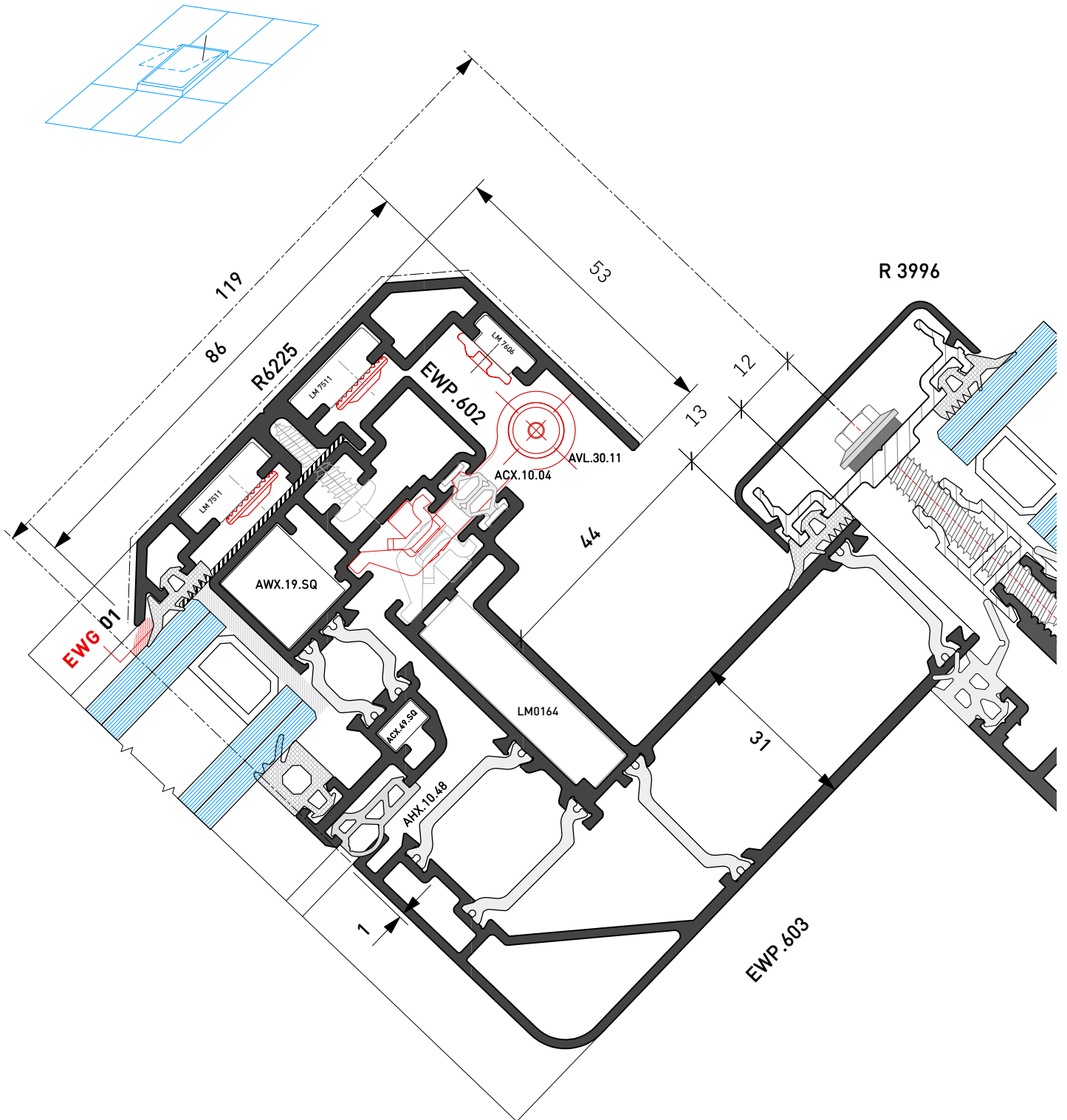

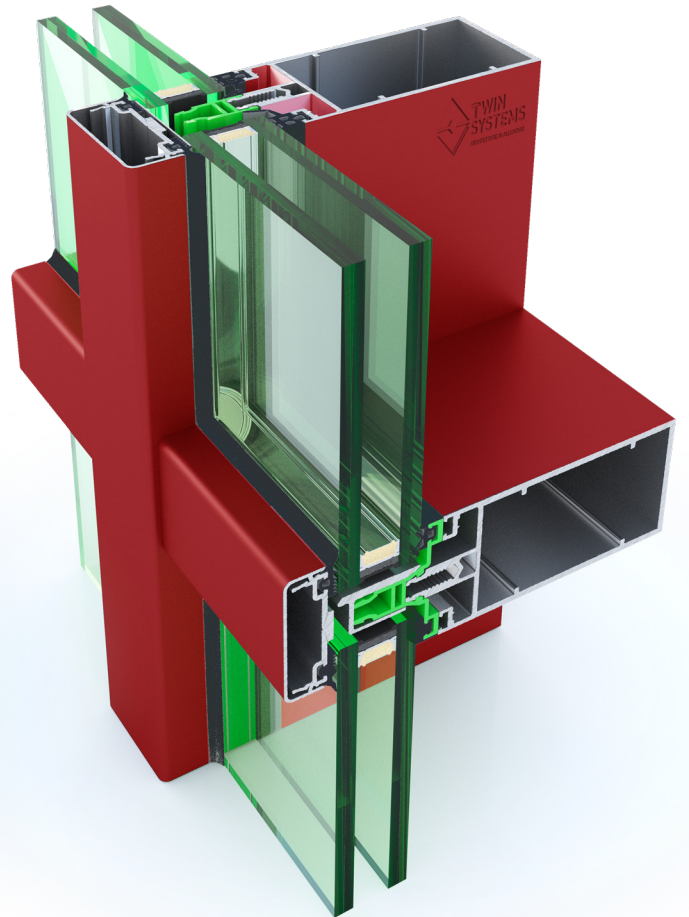
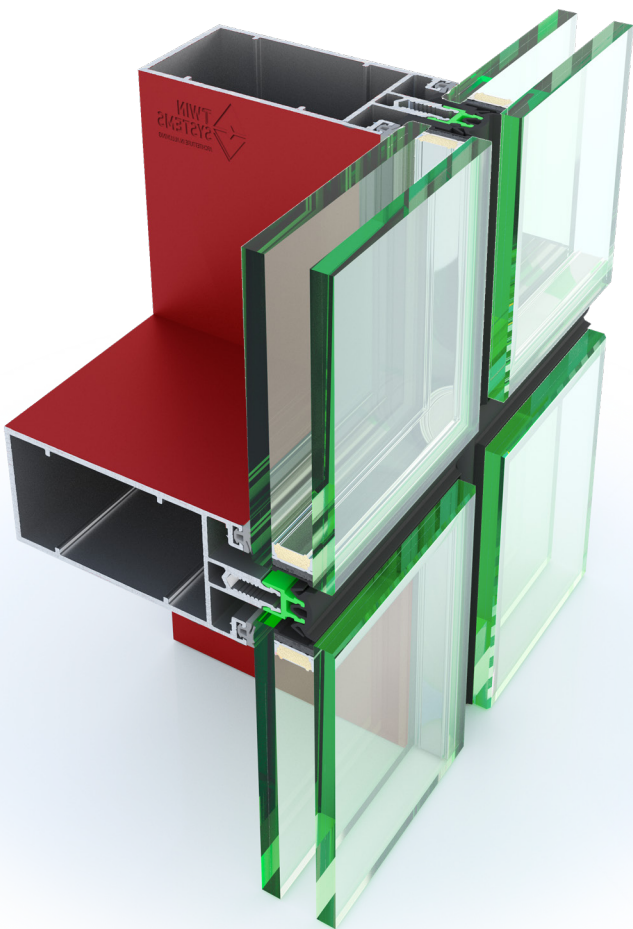

Evolution **GLASS**

Evolution

Tipologie
Types

Gruppo **E**

Tipologie  Main Sections

Evolution



■ Distinta taglio Parti fisse
Cutting list Fixed parts

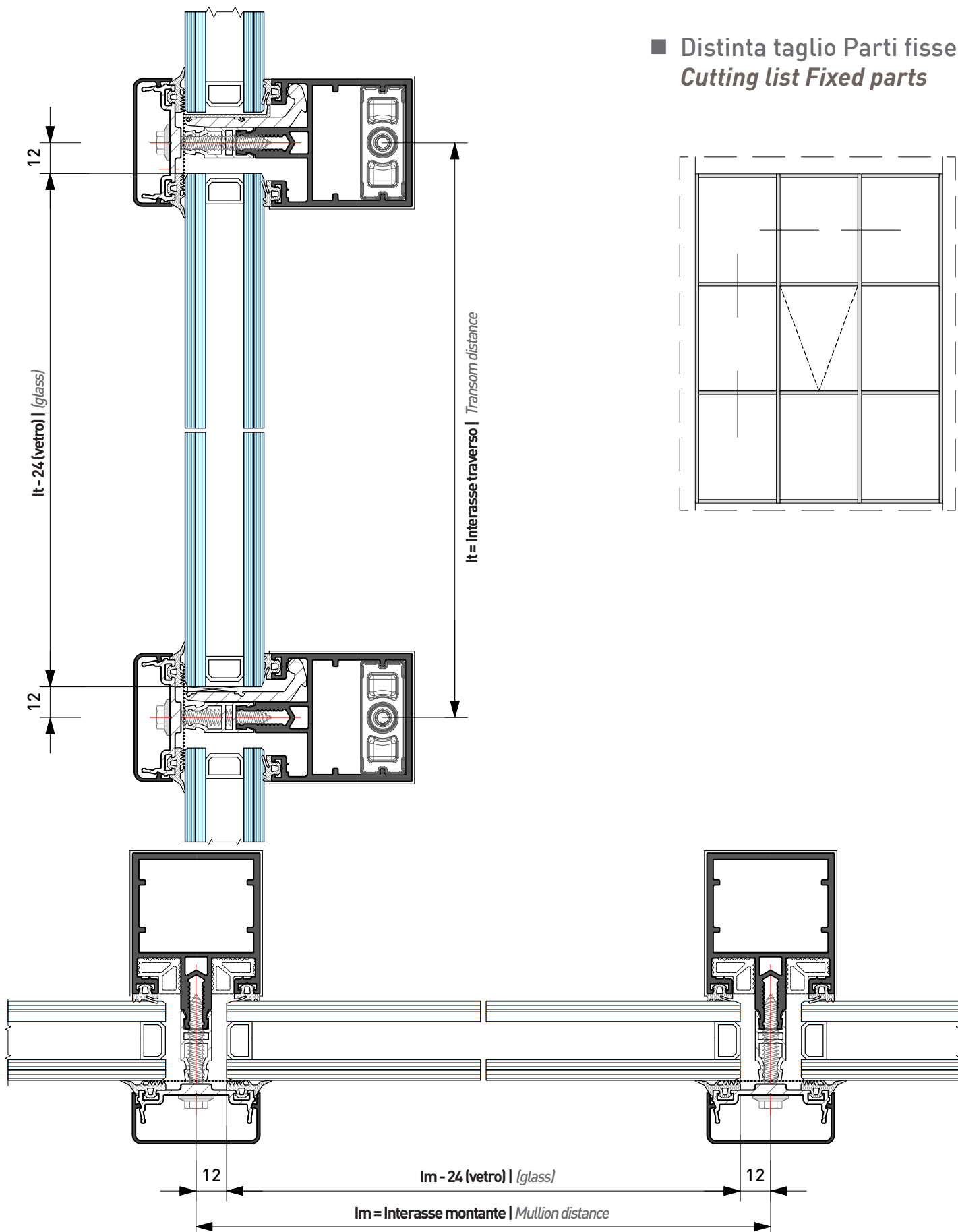

Evolution

■ Distinta taglio Parti apribili
Cutting list Opening parts

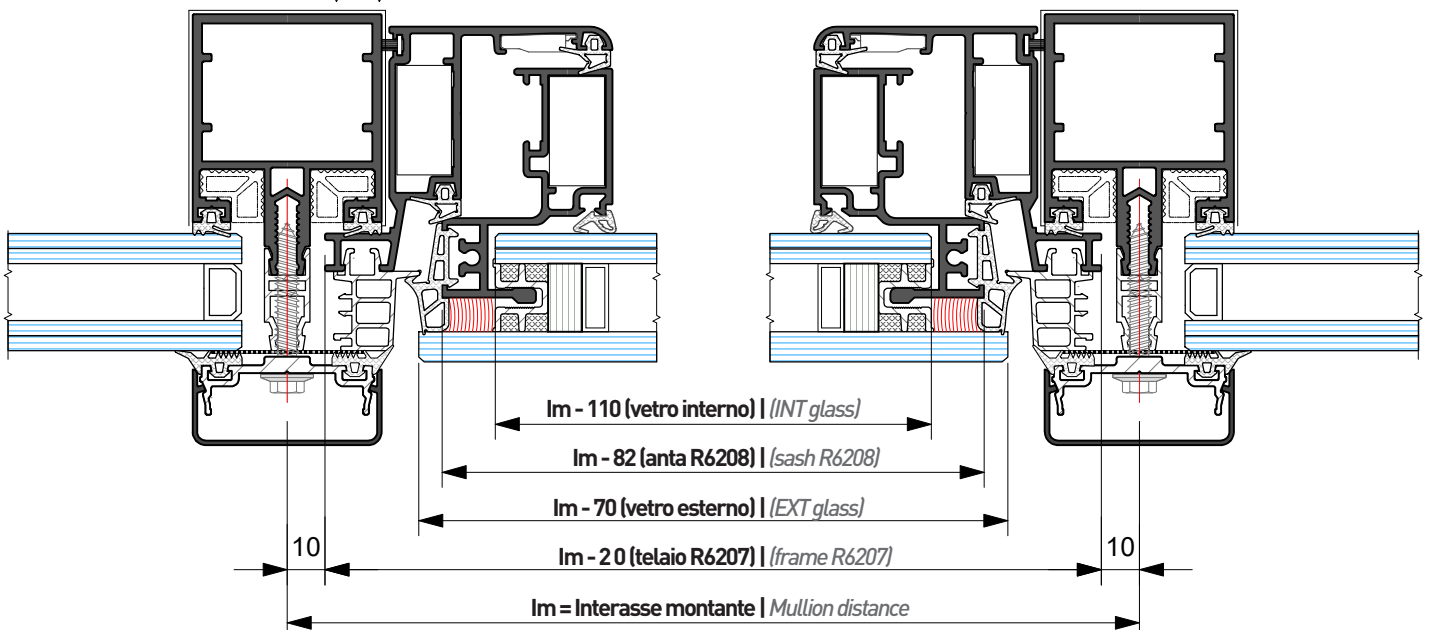
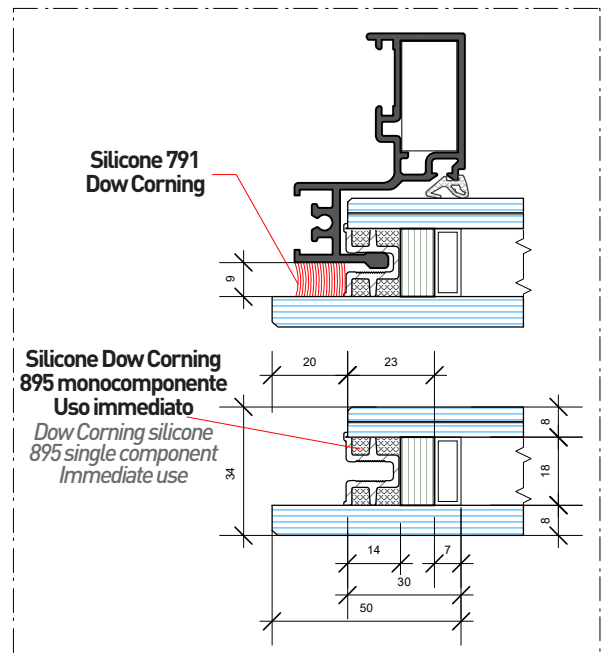
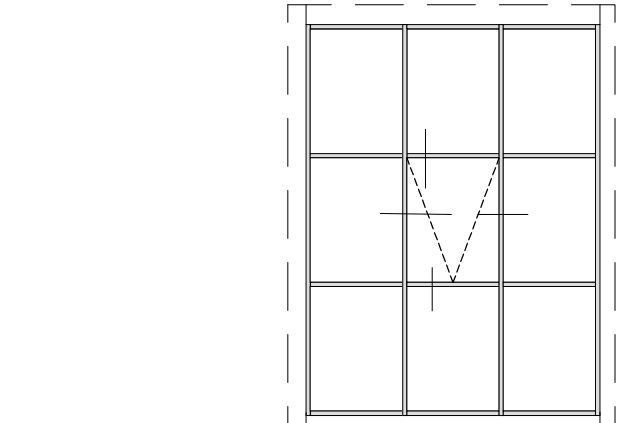
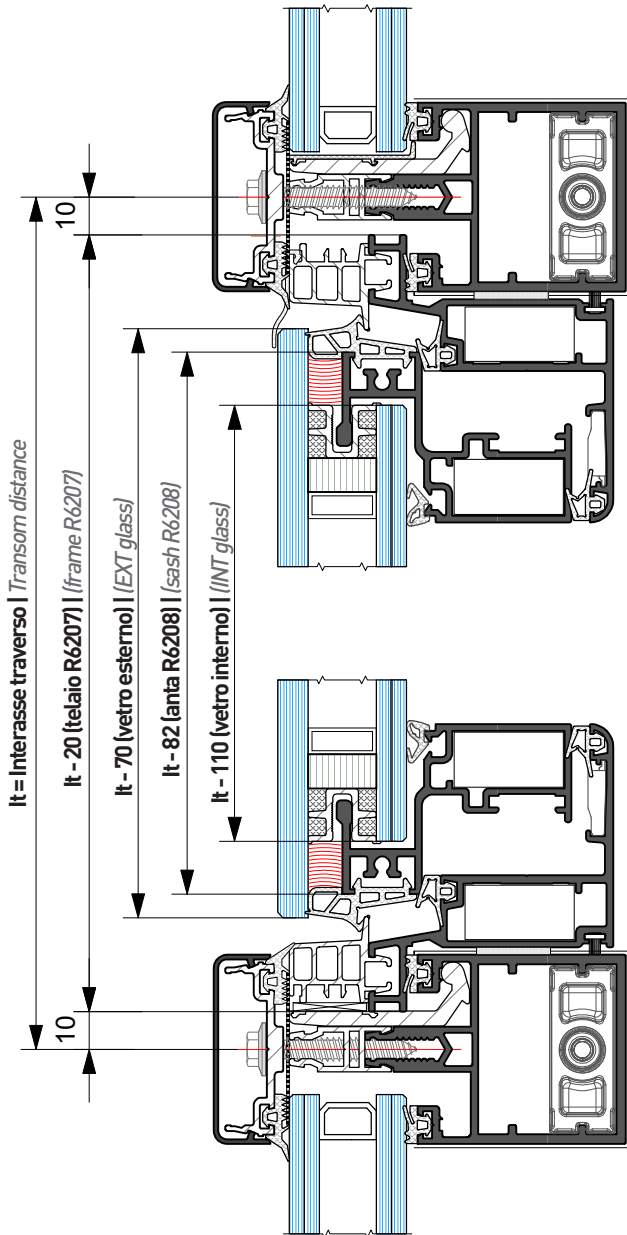

Evolution GLASS



■ Distinta taglio Parti fisse
Cutting list Fixed parts

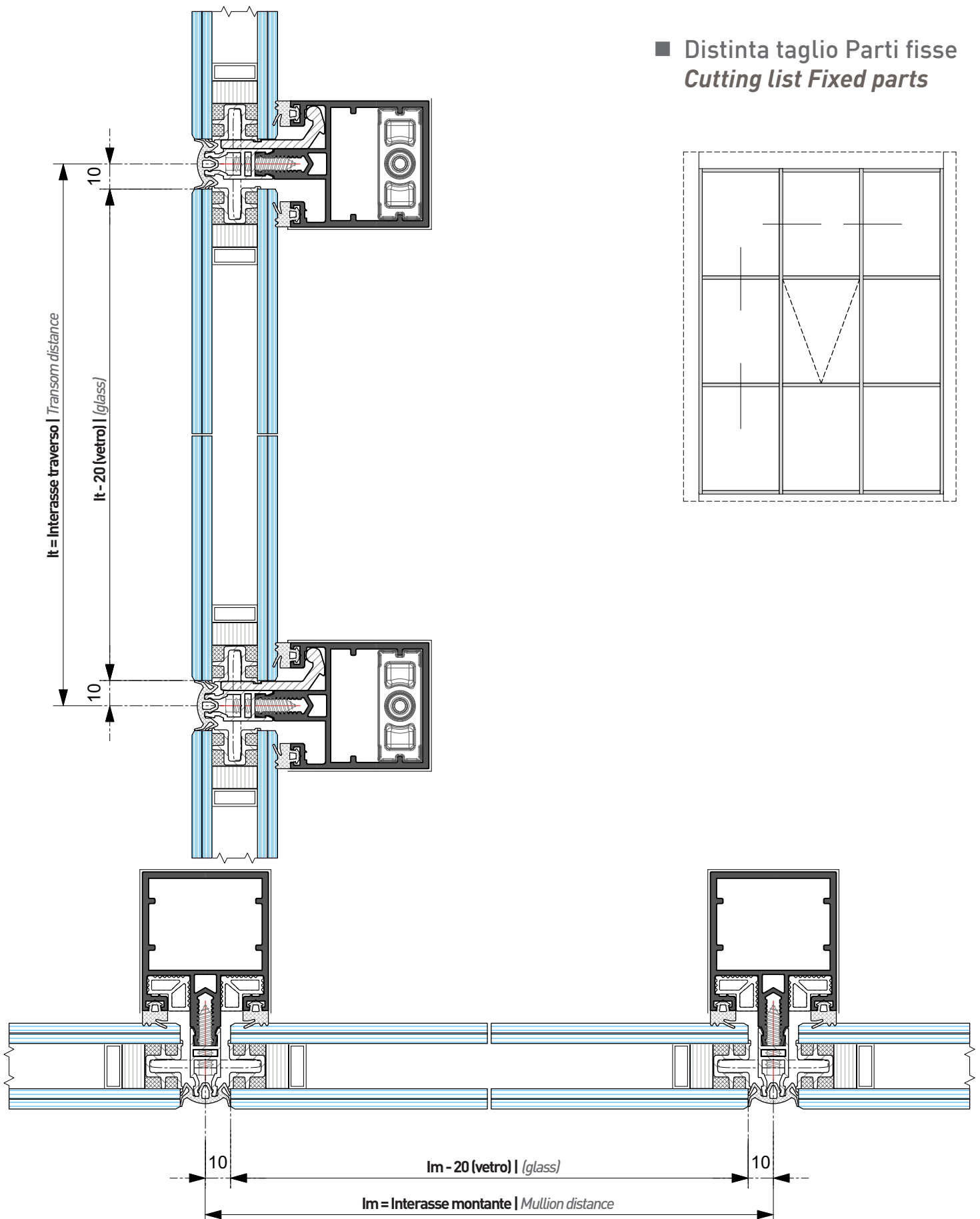

Evolution GLASS

■ Distinta taglio Parti apribili
Cutting list Opening parts

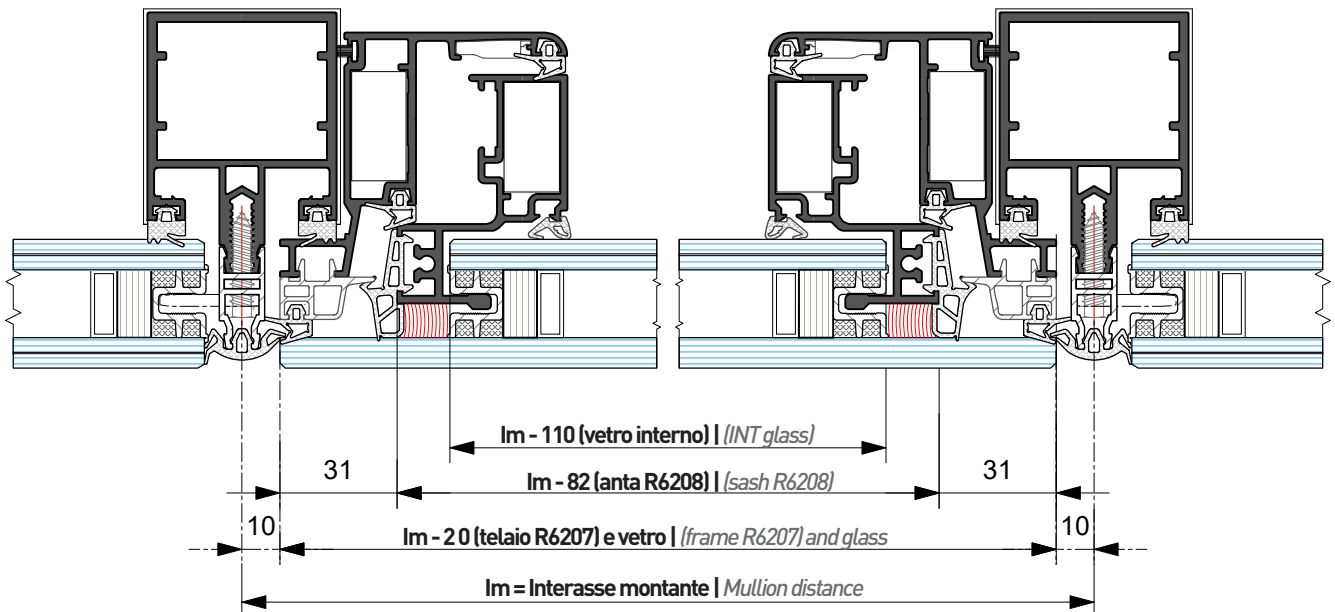
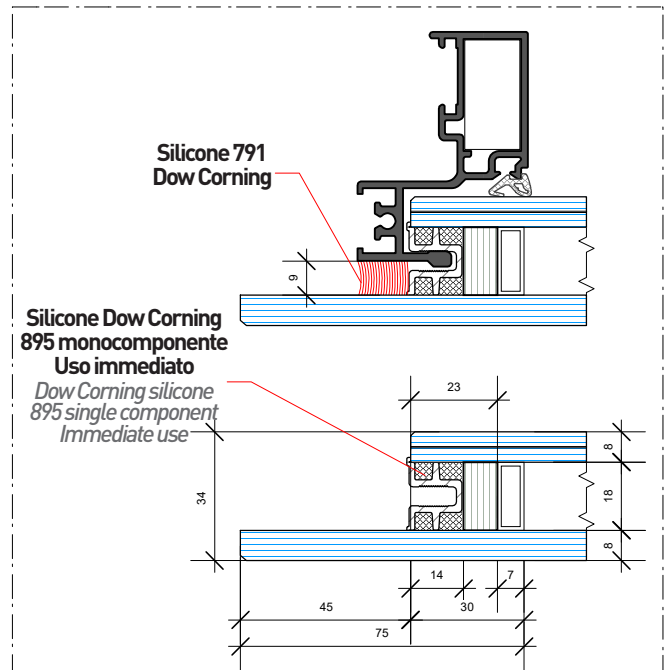
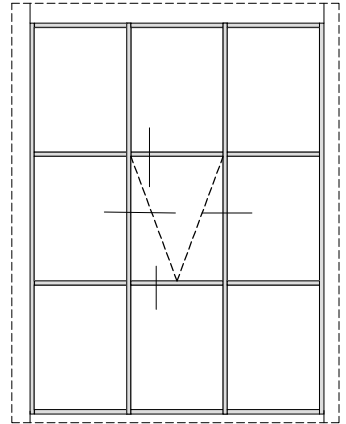
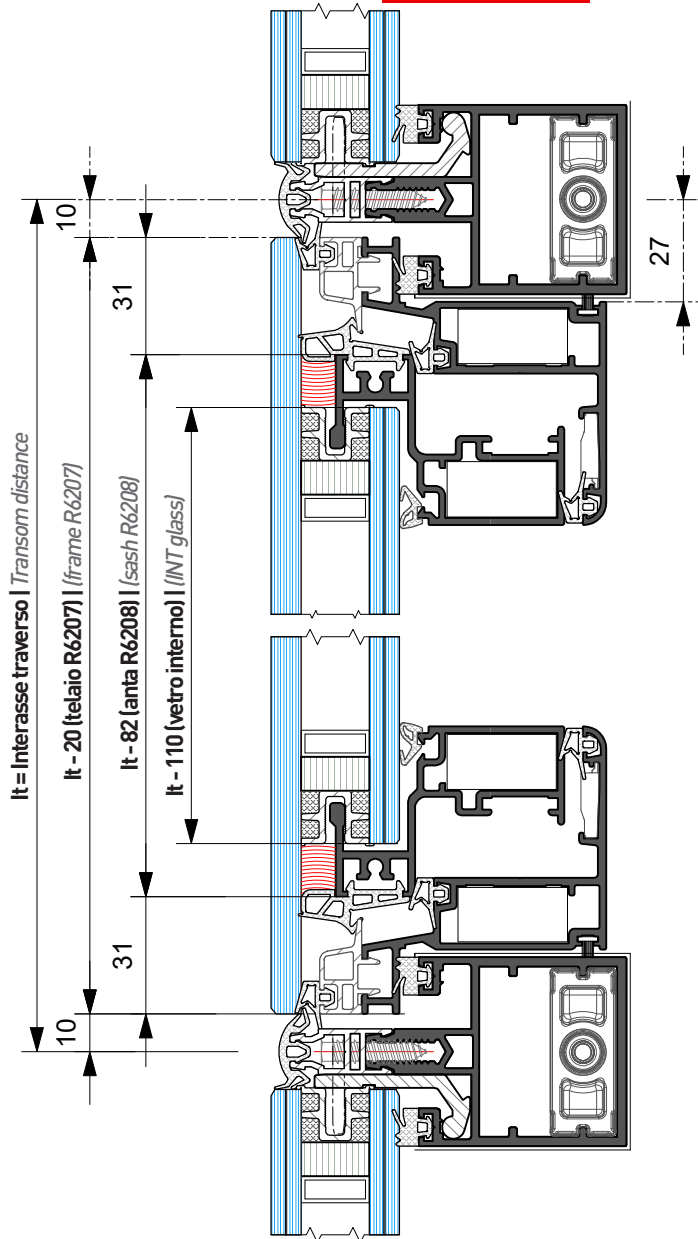



■ Distinta taglio Parti Inclinate con EWA023
Cutting list Opening parts with EWA023

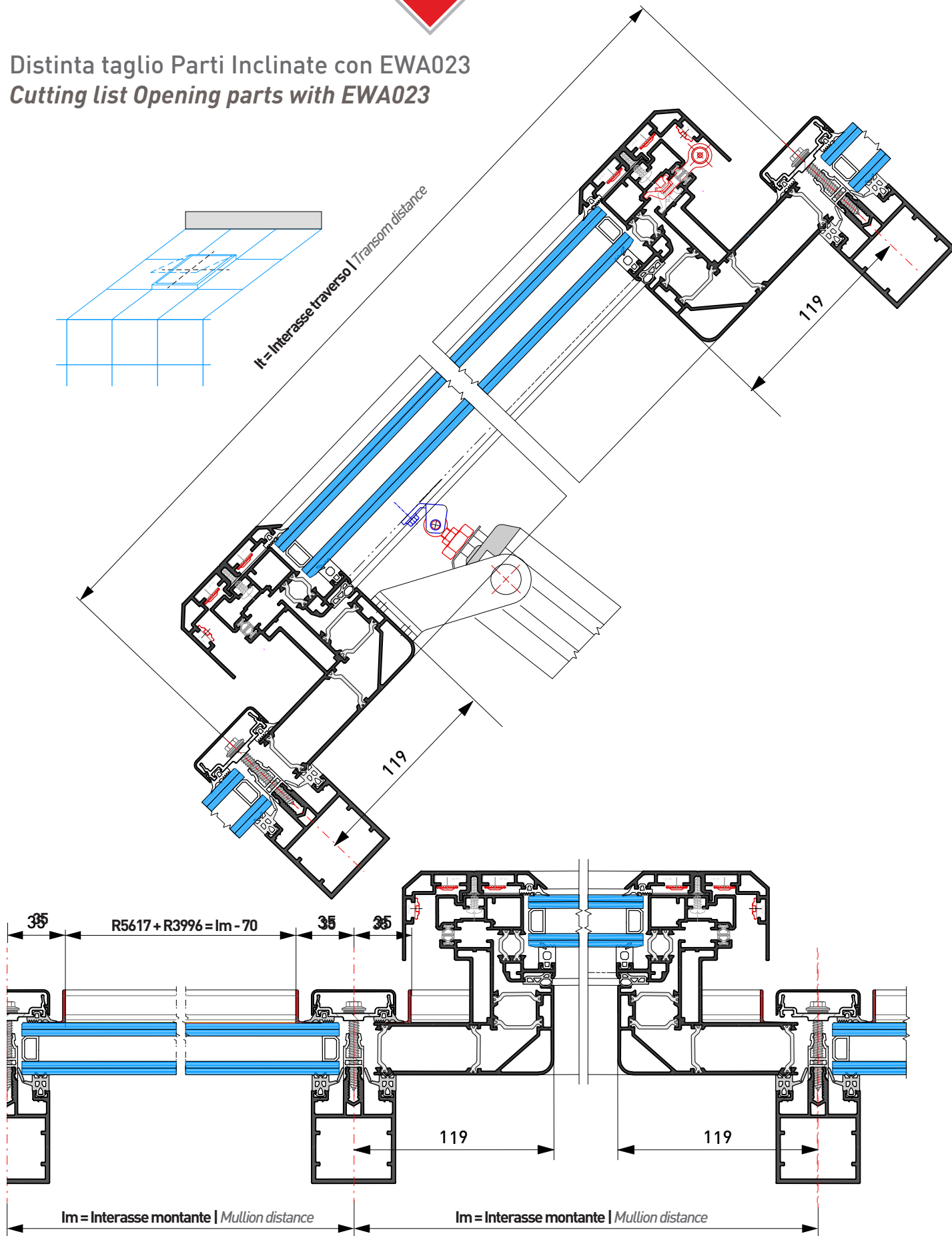

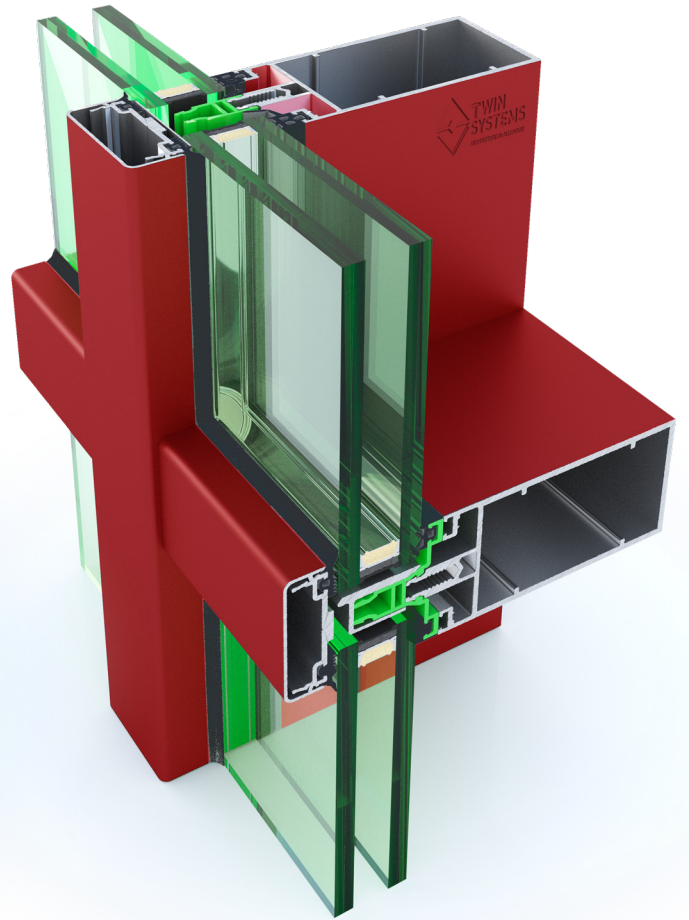
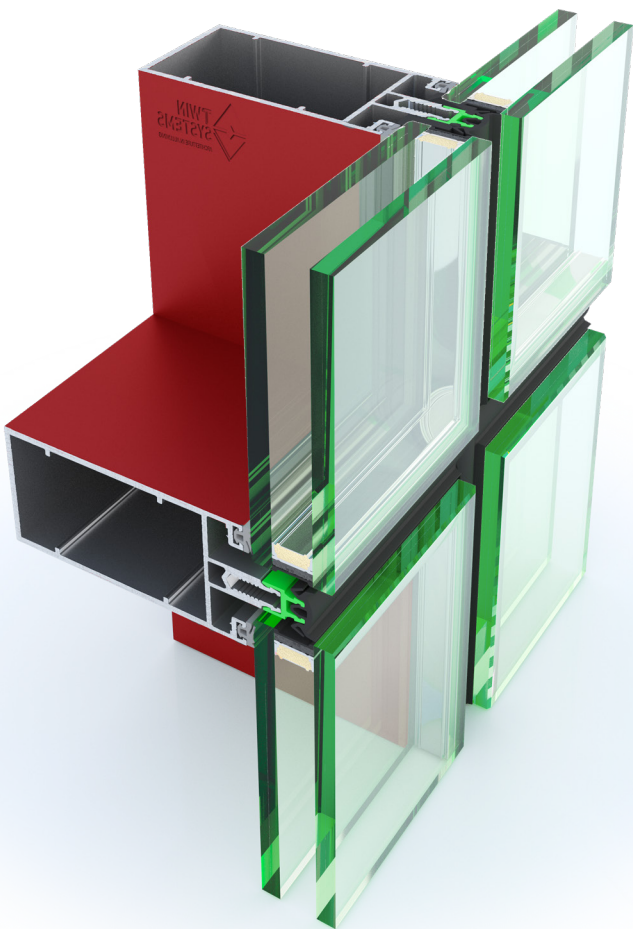

Evolution **GLASS**

Evolution

Attacco alla Muratura
Connection to Brickwork

Gruppo **F**

Sezione particolareggiata
attacco alla muratura

Wall Joint Detail



■ **SCHEMA DI MONTAGGIO FACCIATA CONTINUA (MONTANTI-TRAVERSI)**
▶ *CONTINUOUS FACADE ASSEMBLY DIAGRAM (POSTS-CROSSPIECES)*

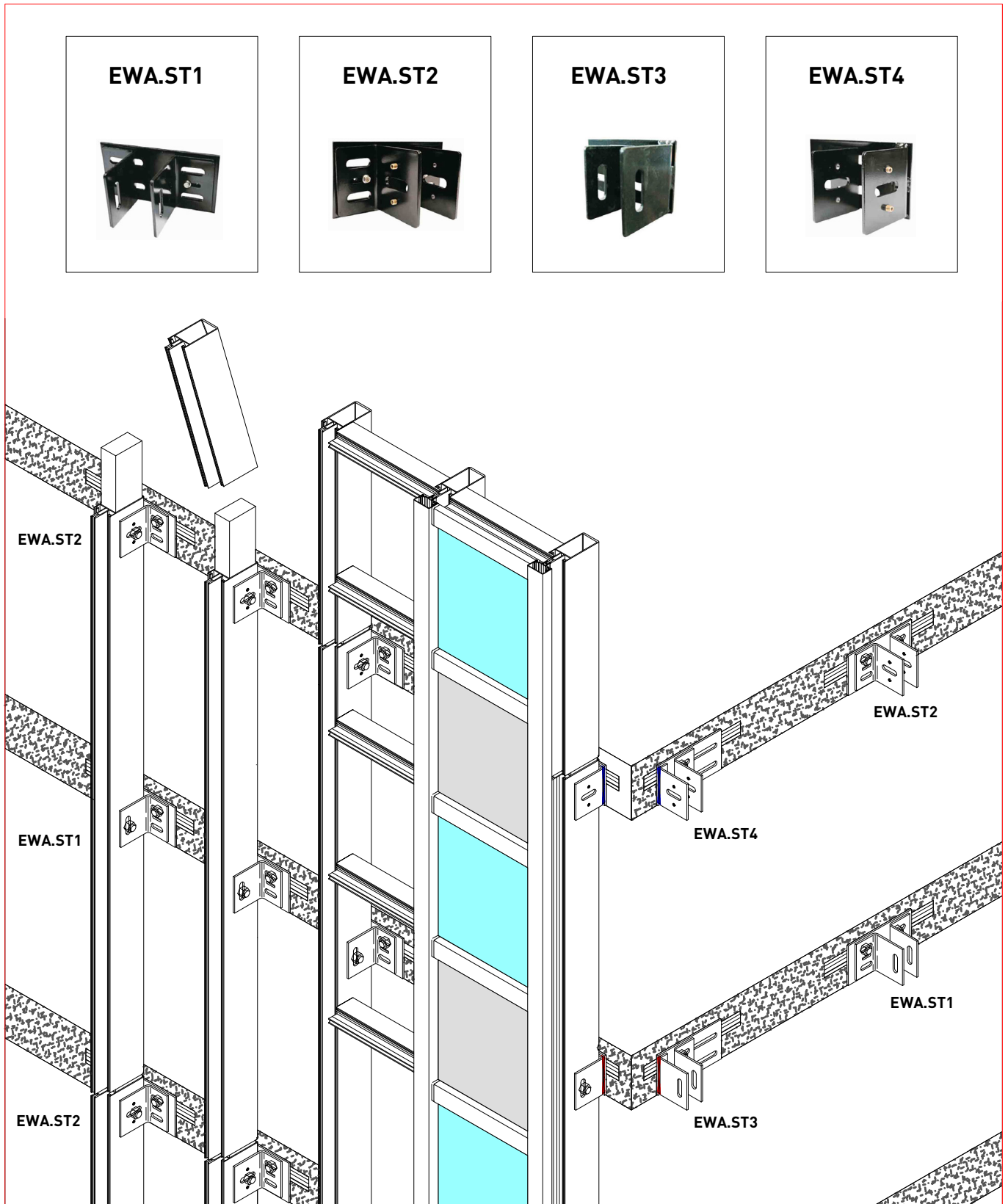



■ **SOLUZIONE CON MONTANTI APPESO**

▶ *SOLUTION WITH HOLDED MULLION*

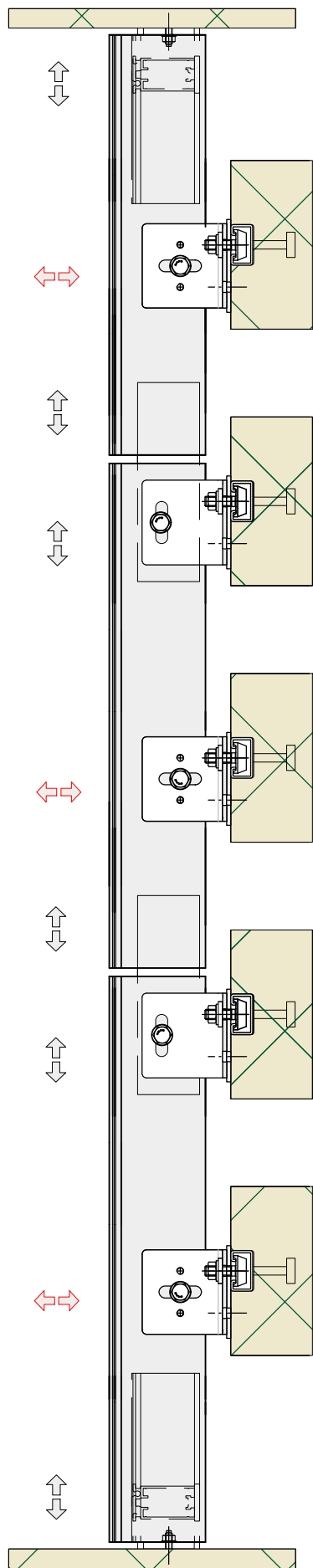

Soluzione con 3 appoggi
Solution with 3 supports

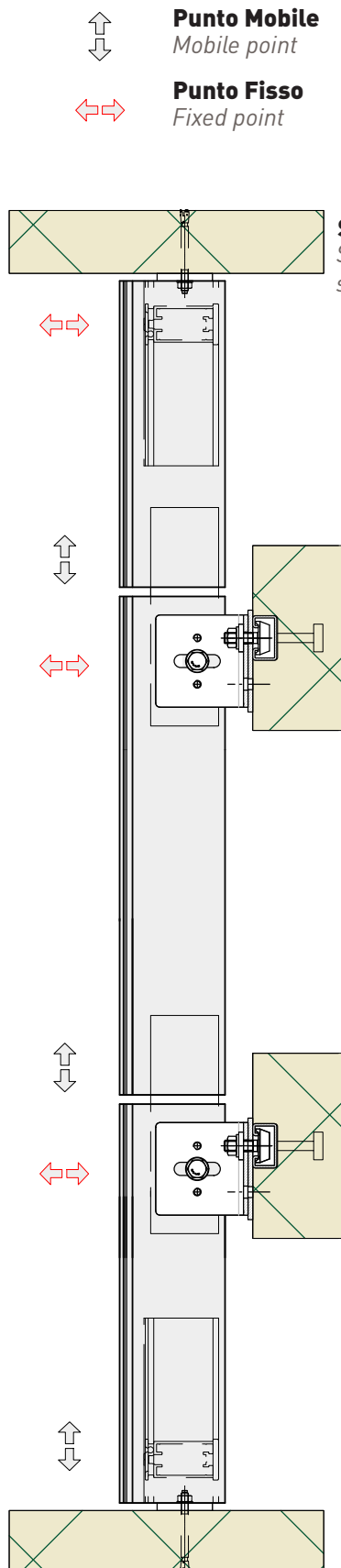

Soluzione con 2 appoggi
Solution with 2 supports

↑ ↓ **Punto Mobile**
Mobile point

↔ **Punto Fisso**
Fixed point



■ **SOLUZIONE CON MONTANTI IN APPOGGIO**
▶ *SOLUTION WITH SUPPORTED MULLION*

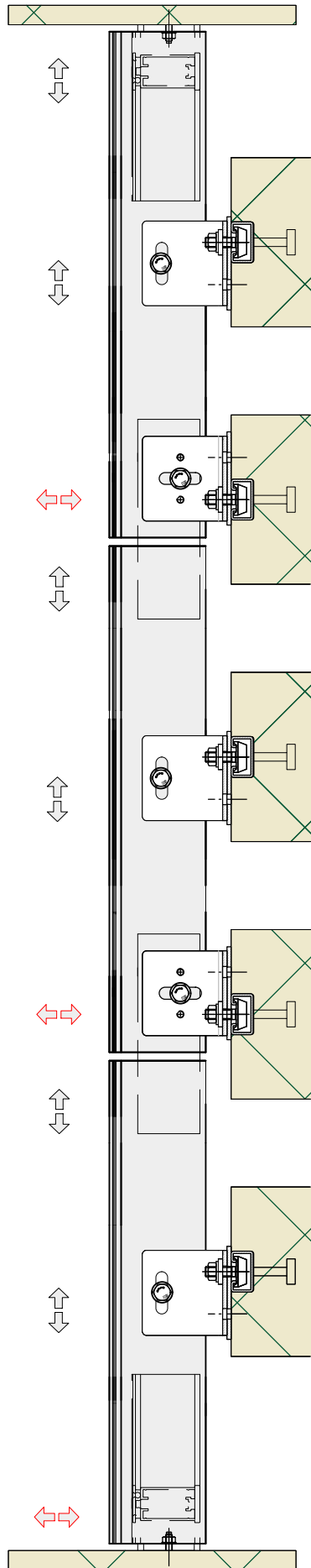

Soluzione con 3 appoggi
Solution with 3 supports

 **Punto Mobile**
Mobile point
 **Punto Fisso**
Fixed point

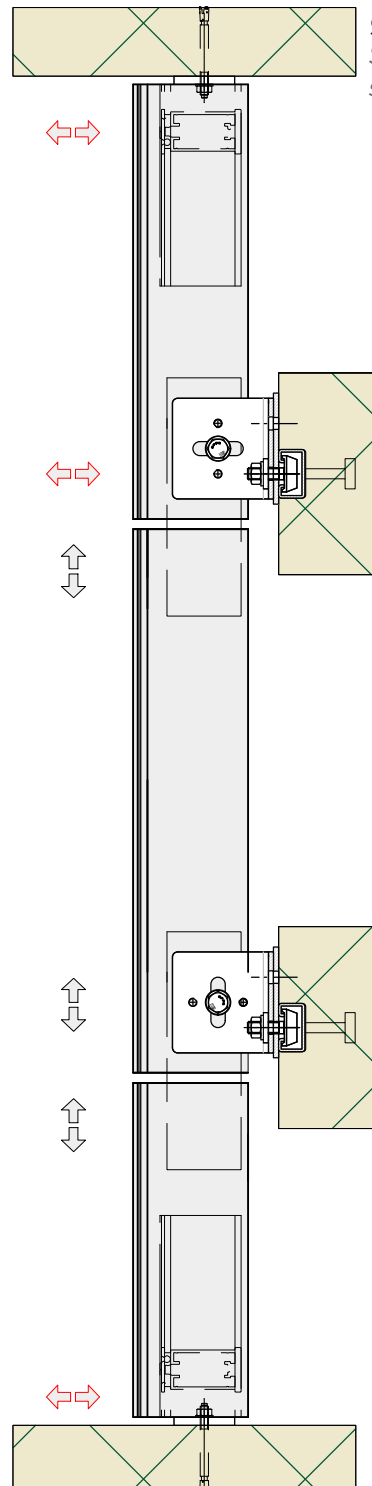

Soluzione con 2 appoggi
Solution with 2 supports



■ ESEMPI DI APPLICAZIONE

► *Installation Examples*

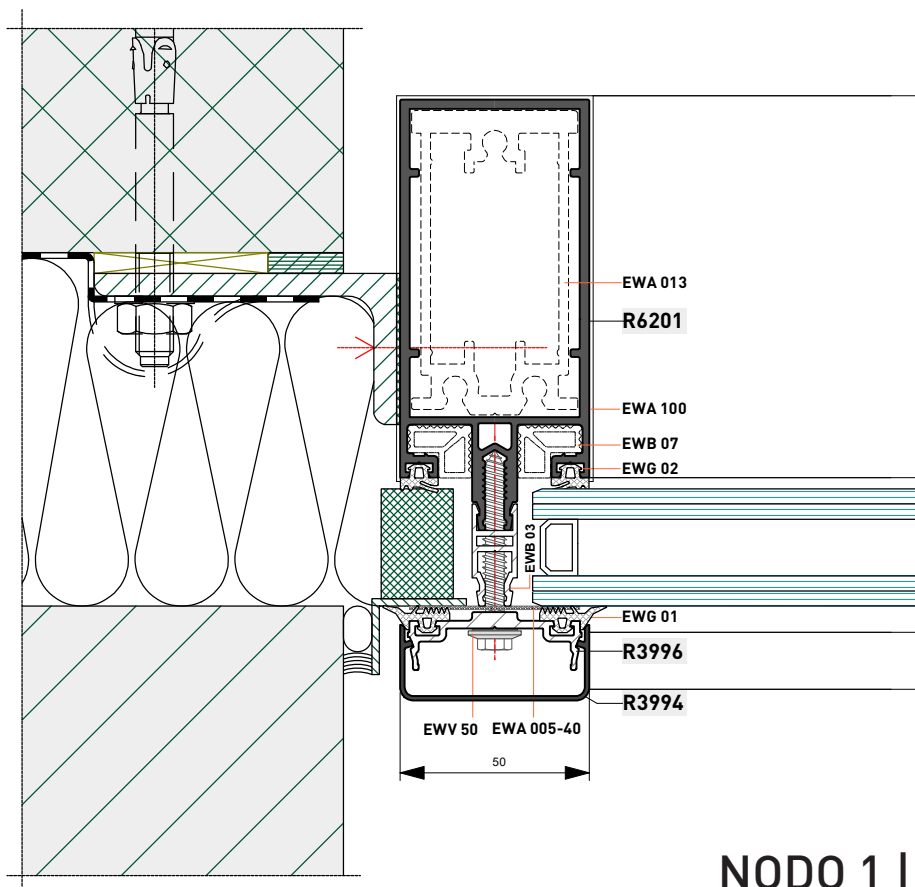

NODO 1 | *Node 1*

■ ESEMPI DI APPLICAZIONE

► *Installation Examples*

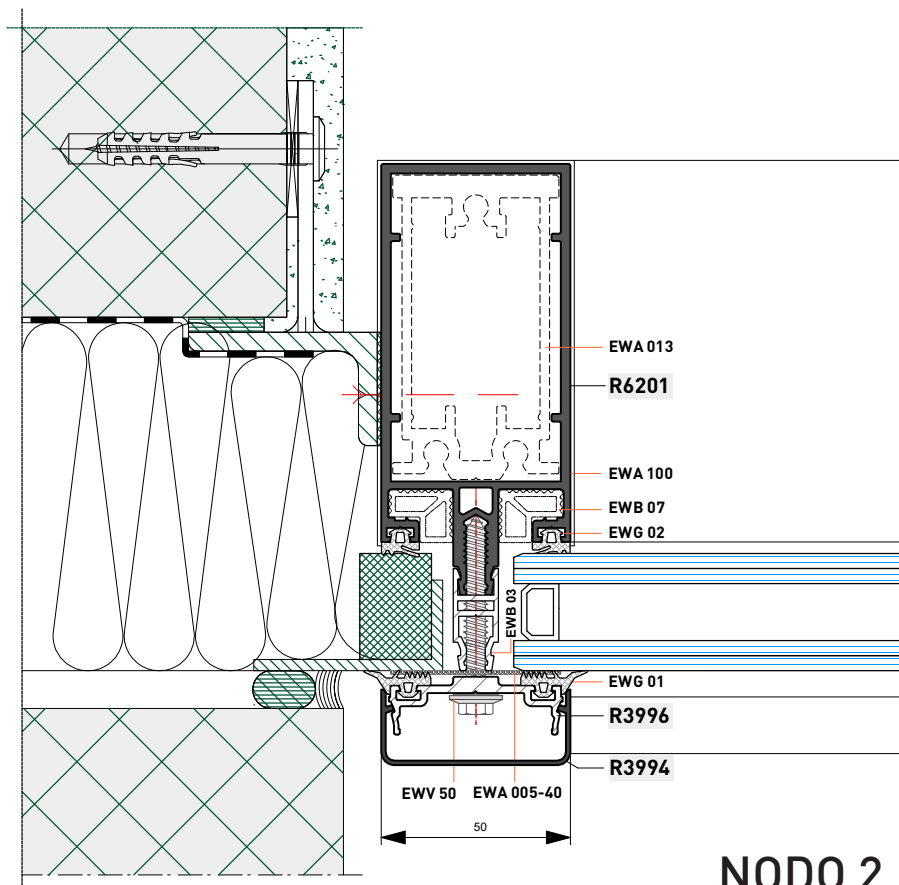

NODO 2 | *Node 2*



■ ESEMPI DI
APPLICAZIONE

► *Installation Examples*

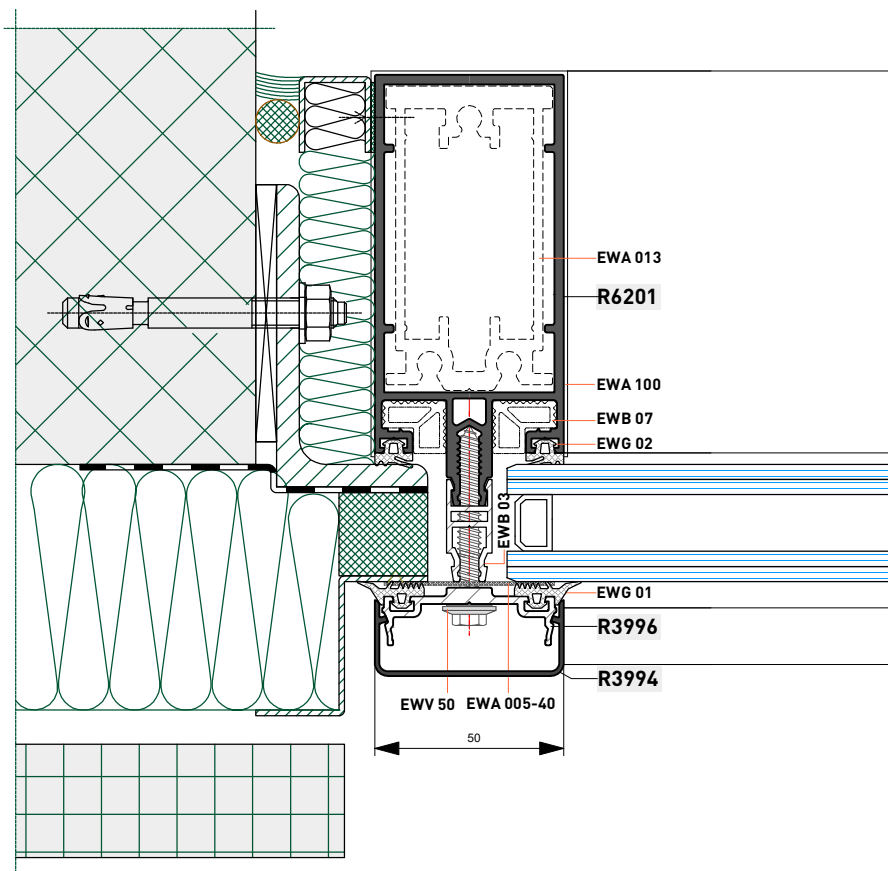

NODO 3 | Node 3

■ ESEMPI DI
APPLICAZIONE

► *Installation Examples*

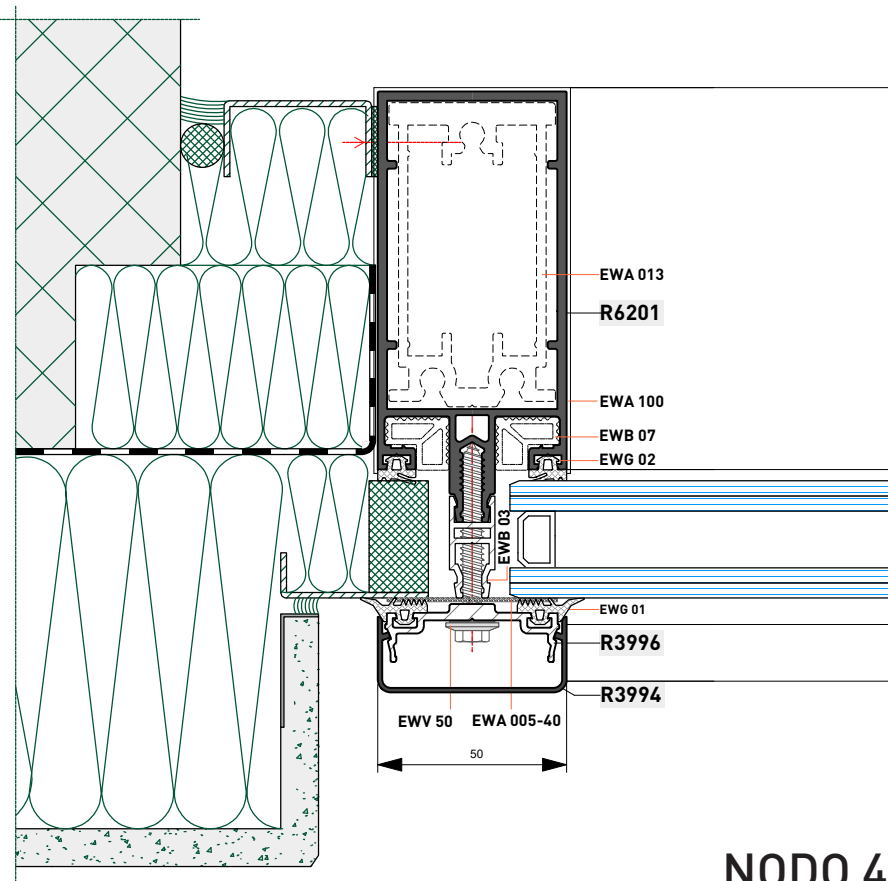

NODO 4 | Node 4



■ ESEMPI DI APPLICAZIONE

► *Installation Examples*

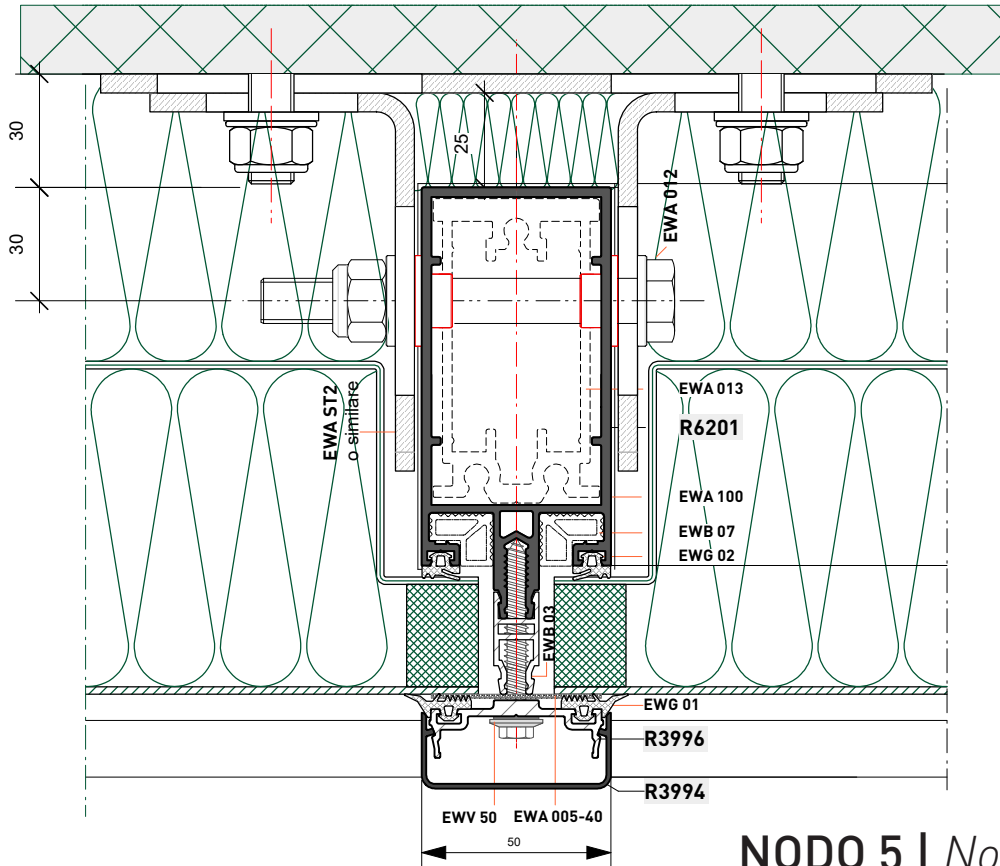

NODO 5 | Node 5

■ ESEMPI DI APPLICAZIONE

► *Installation Examples*

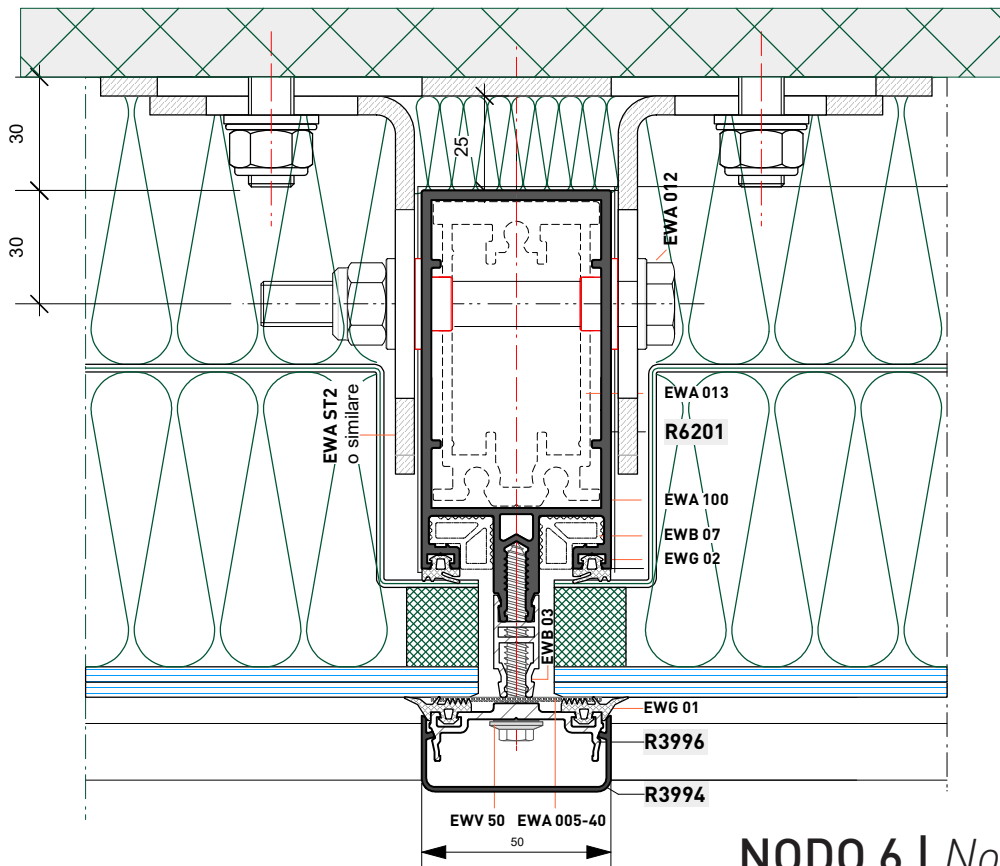

NODO 6 | Node 6

■ ESEMPI DI
APPLICAZIONE

► *Installation Examples*

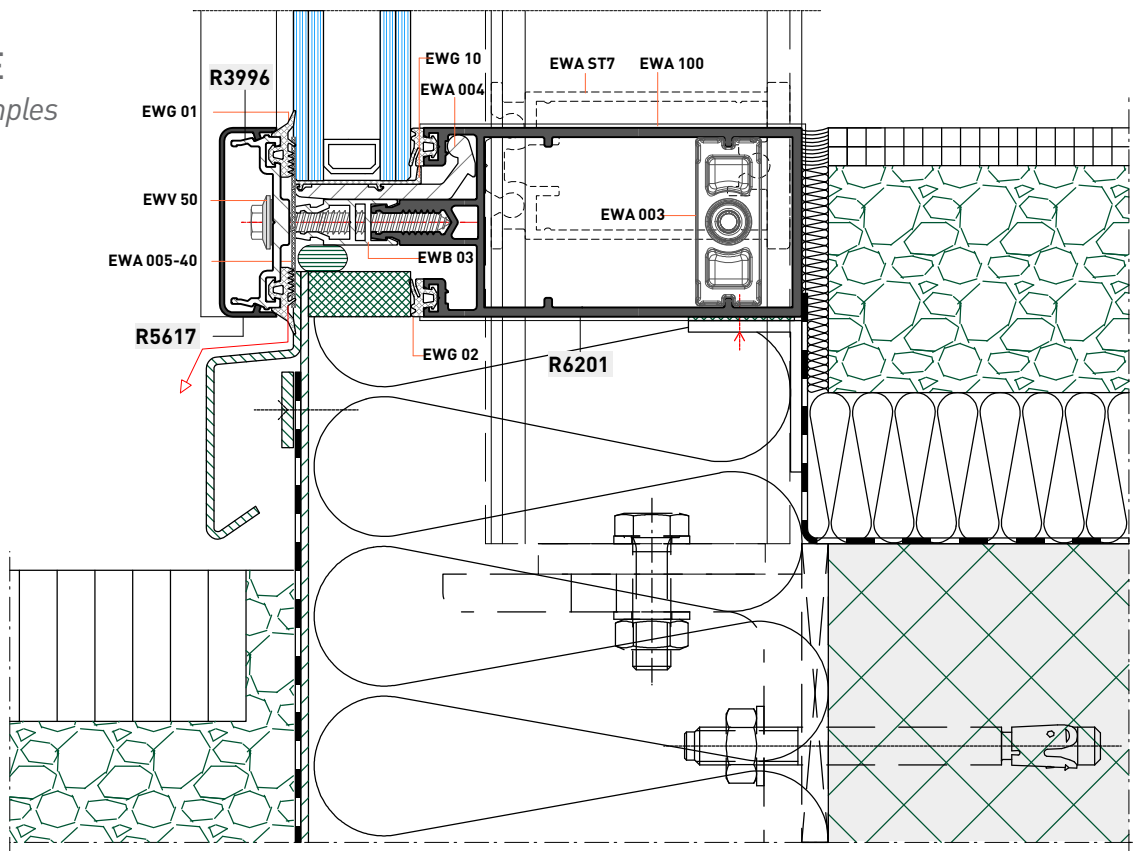

NODO 7 | Node 7

■ ESEMPI DI
APPLICAZIONE

► *Installation Examples*

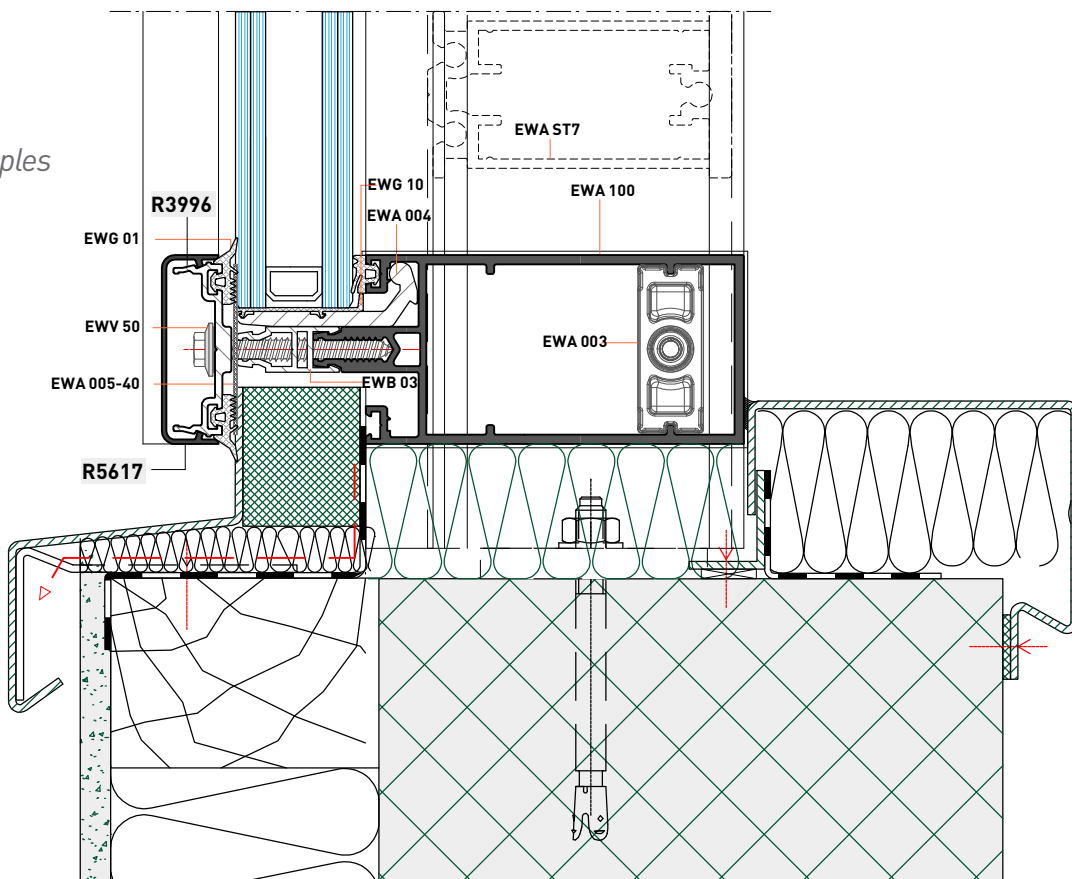

NODO 8 | Node 8



Evolution

■ ESEMPI DI APPLICAZIONE

► *Installation Examples*

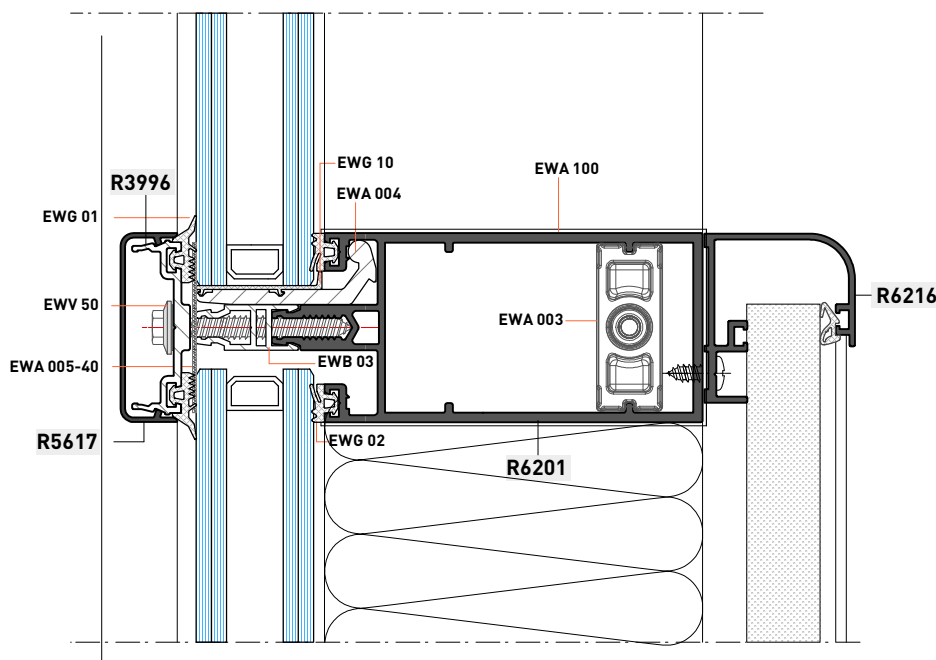

NODO 9 | Node 9

■ ESEMPI DI APPLICAZIONE

► *Installation Examples*

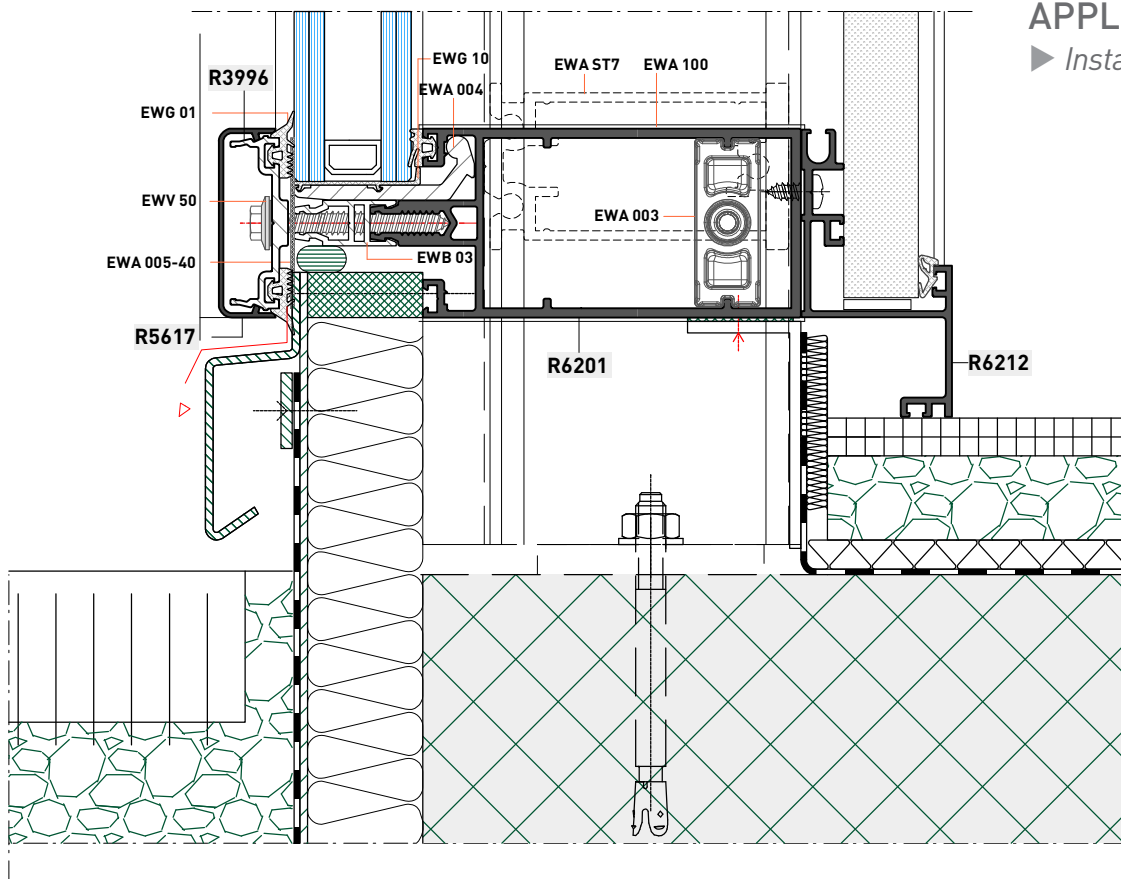

NODO 10 | Node 10



Evolution

■ ESEMPI DI
APPLICAZIONE

► *Installation Examples*

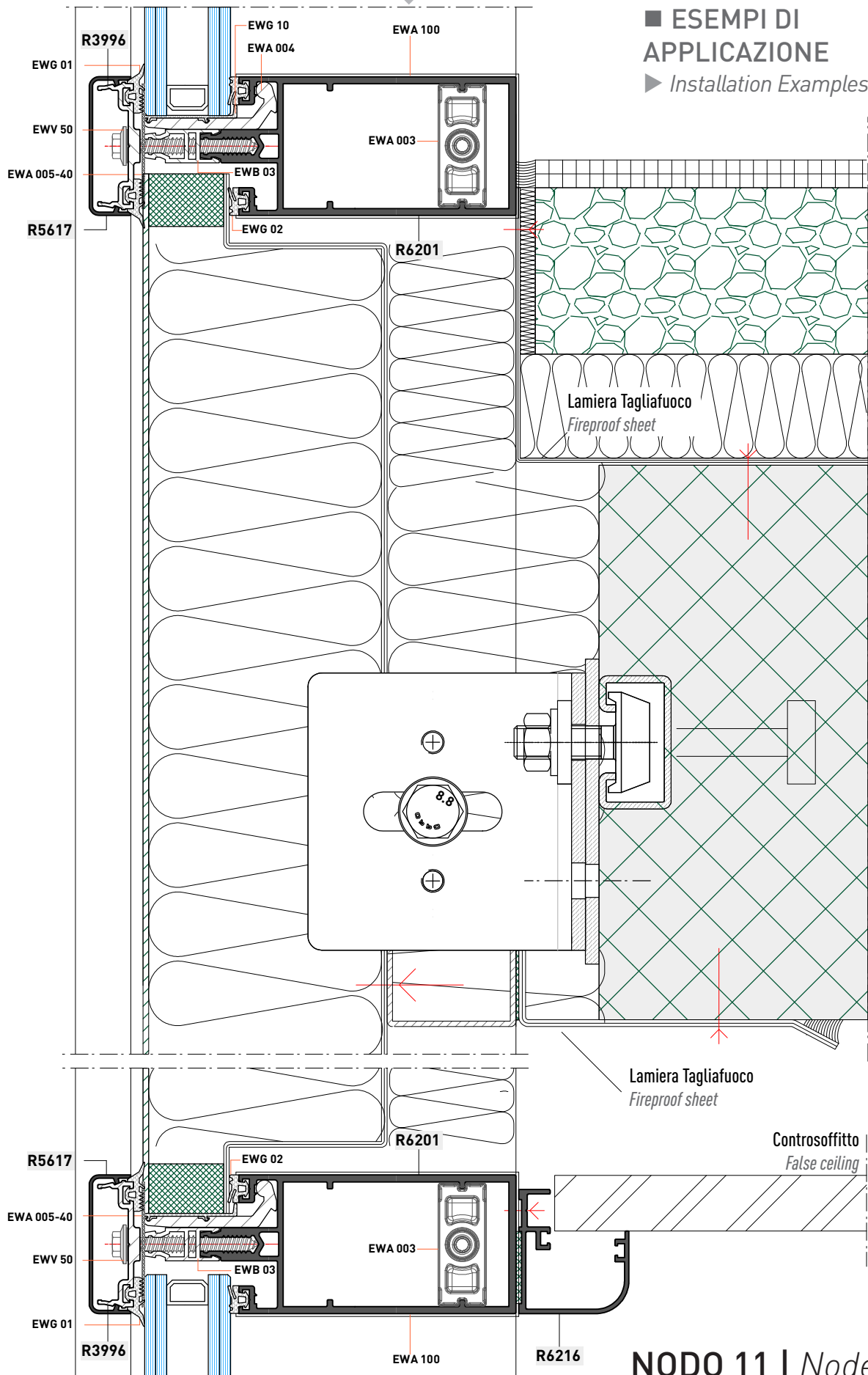

NODO 11 | Node 11



Evolution

■ ESEMPI DI
APPLICAZIONE

► *Installation Examples*

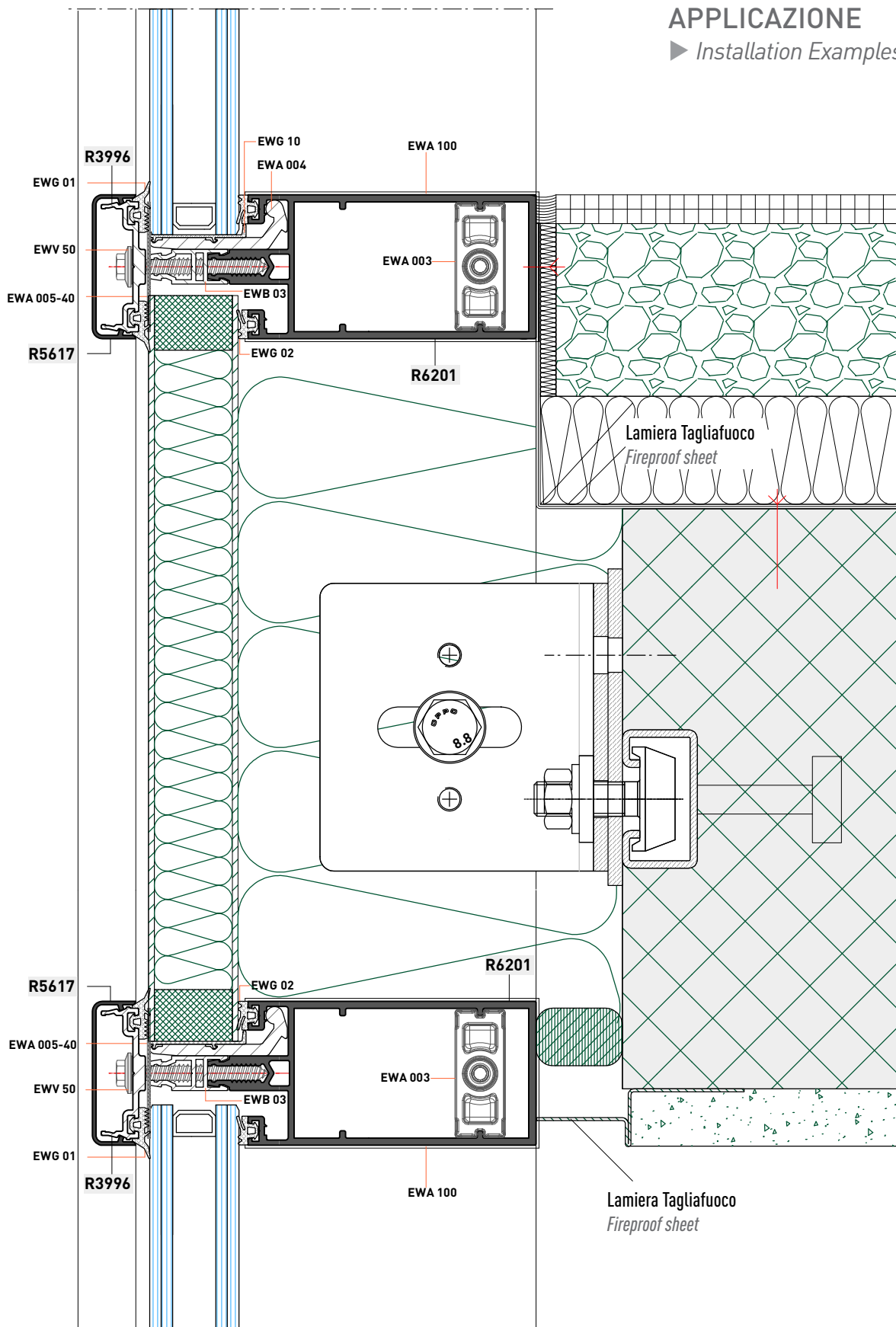

NODO 12 | Node 12



■ ESEMPI DI
APPLICAZIONE

► *Installation Examples*

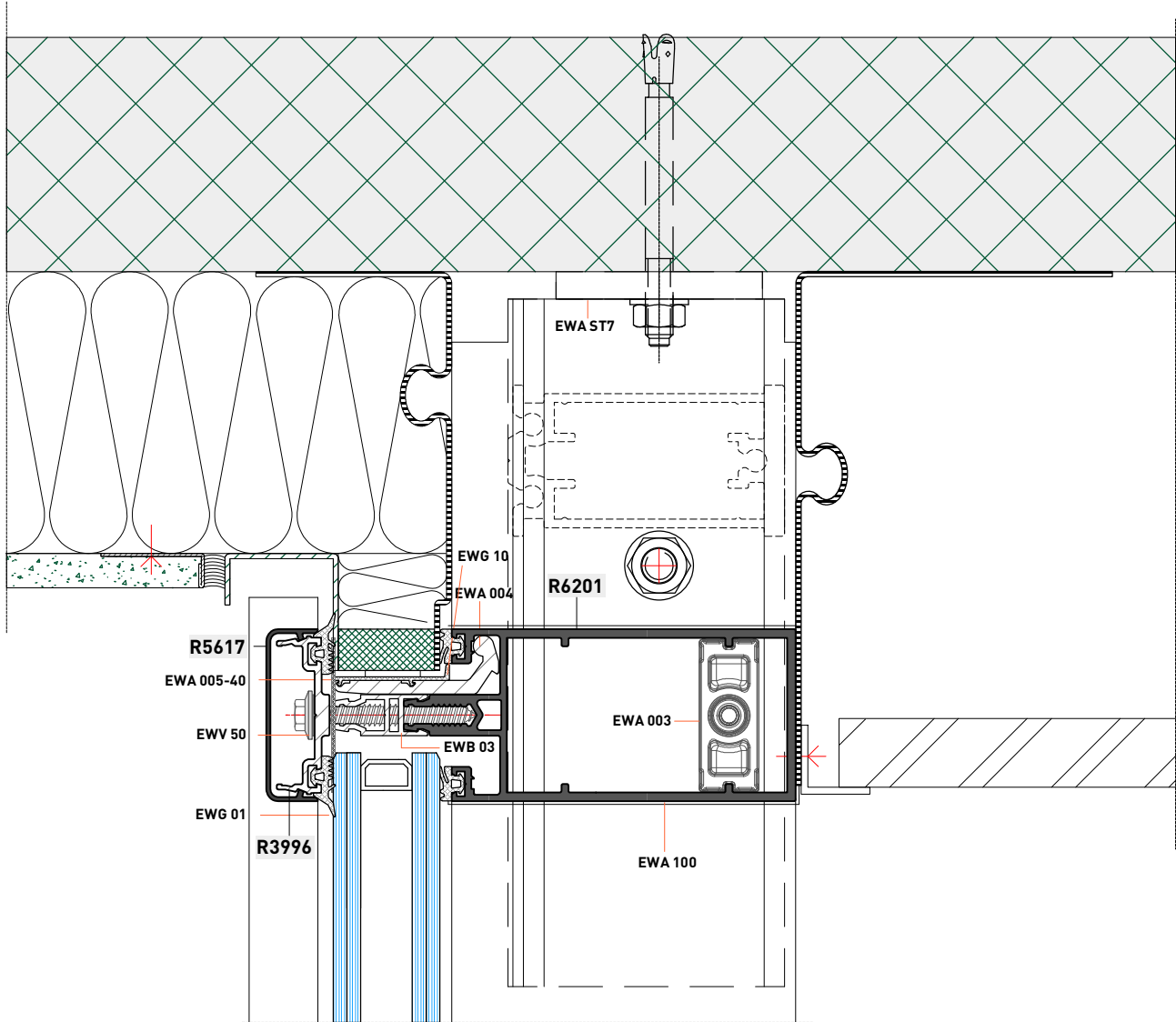

Evolution

- ESEMPI DI APPLICAZIONE
- *Installation Examples*

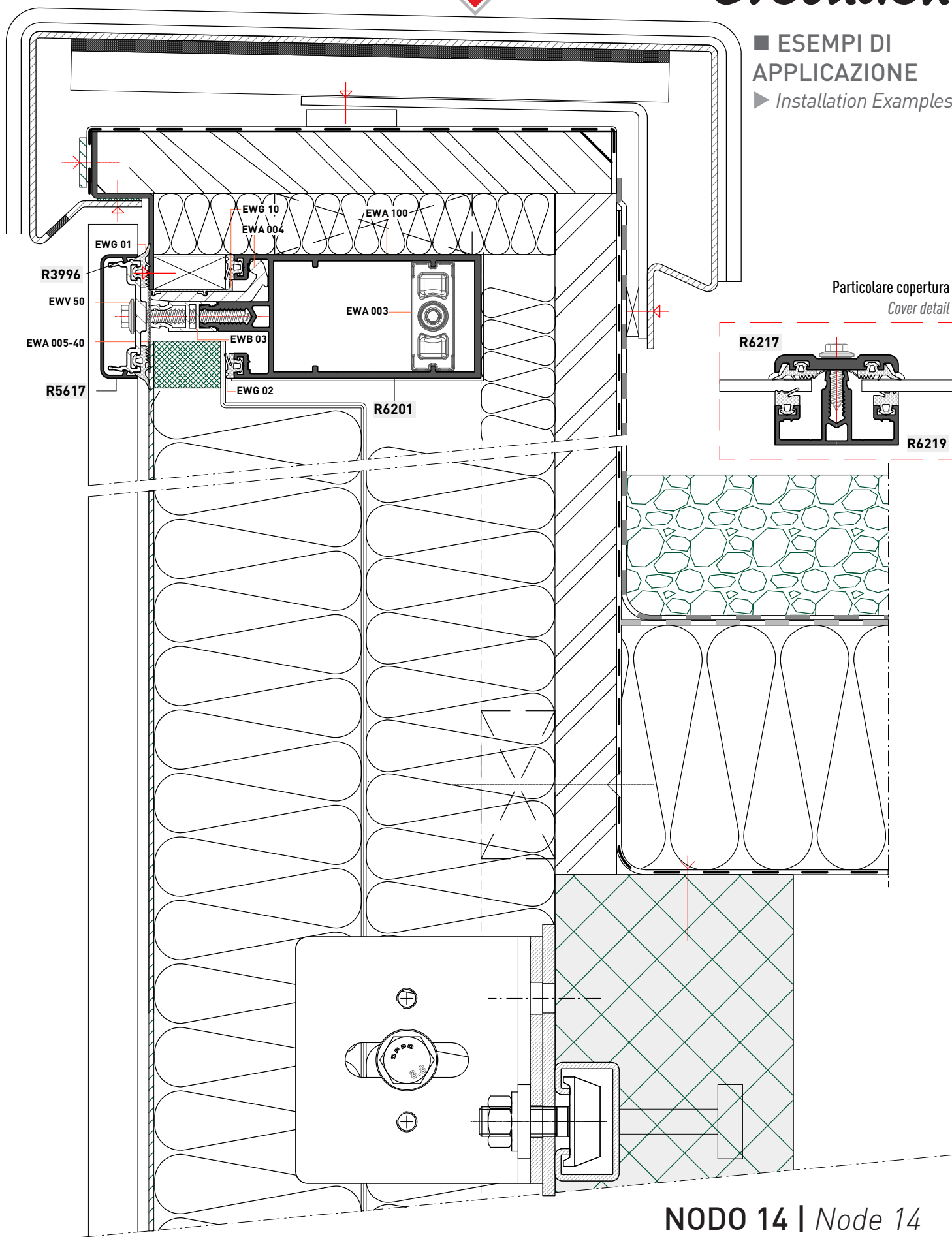

NODO 14 | Node 14



■ ESEMPI DI
APPLICAZIONE

► *Installation Examples*

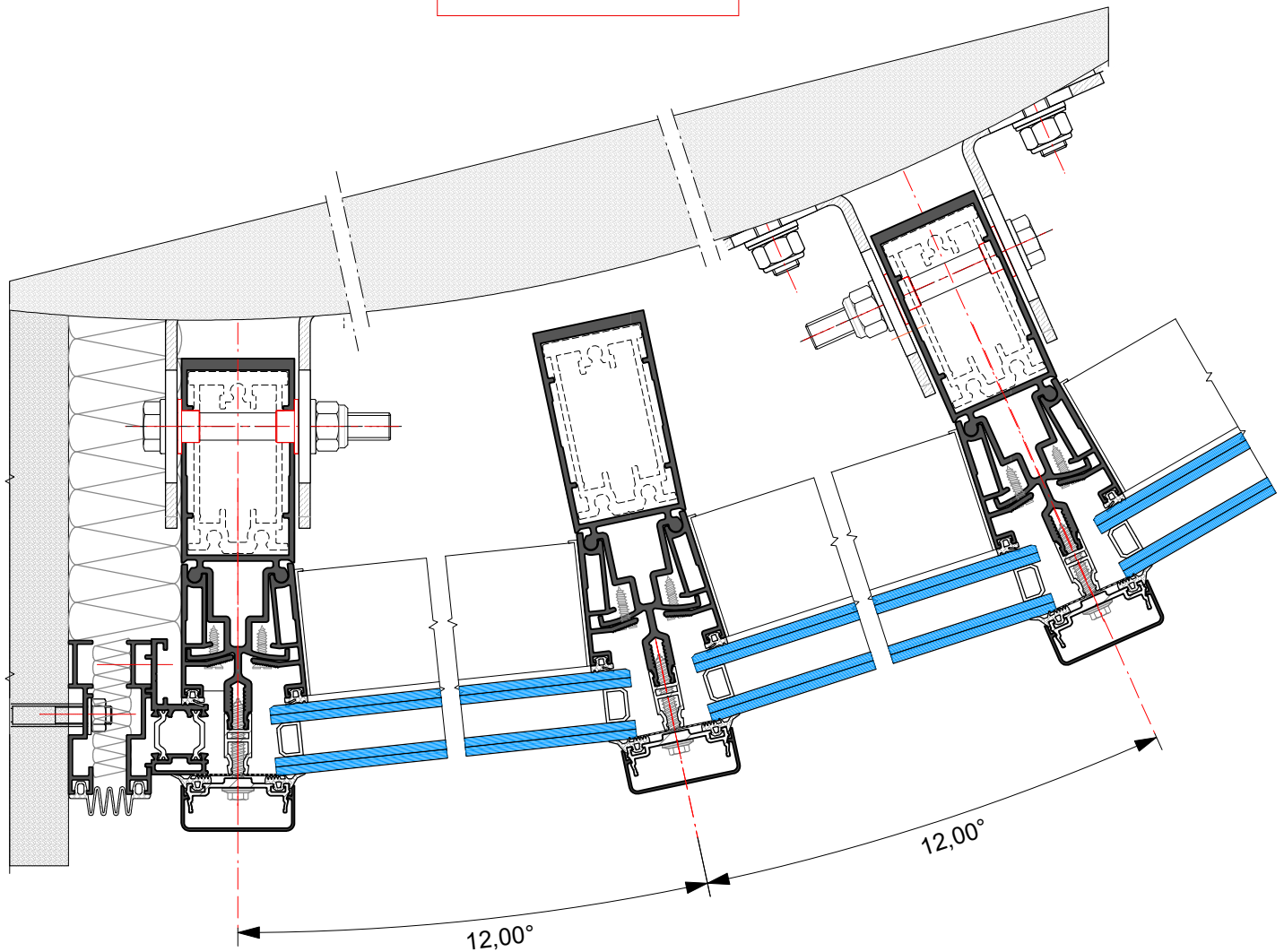
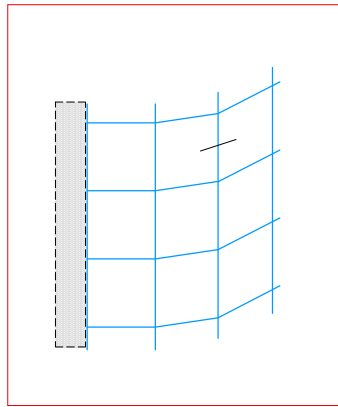

NODO 15 | Node 15



■ **ESEMPI DI APPLICAZIONE**

Facciata inclinata

► *Installation Examples*

Inclined facade

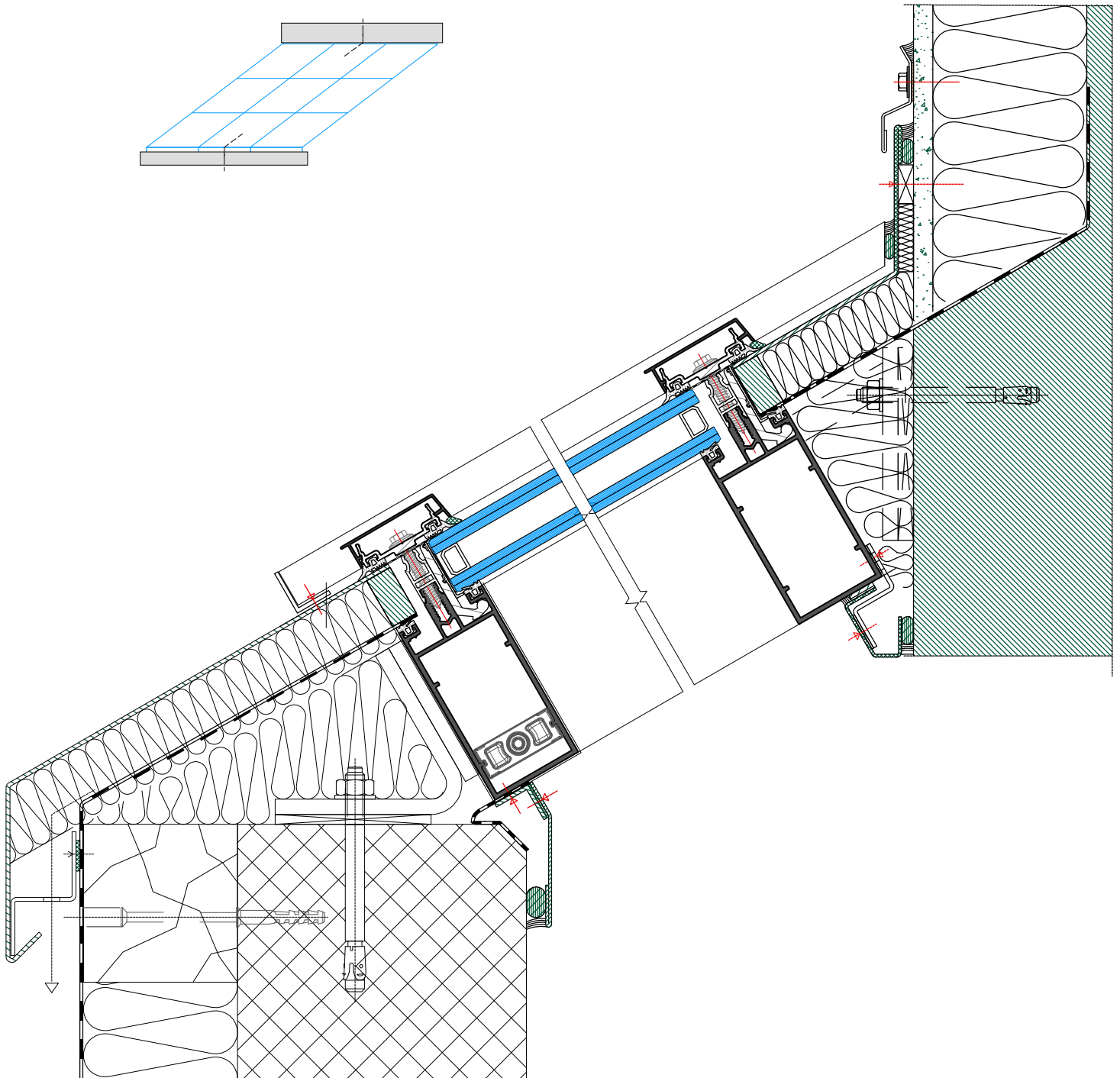

NODO 16 | Node 16



■ ESEMPI DI APPLICAZIONE

Facciata inclinata

► *Installation Examples*

Inclined facade

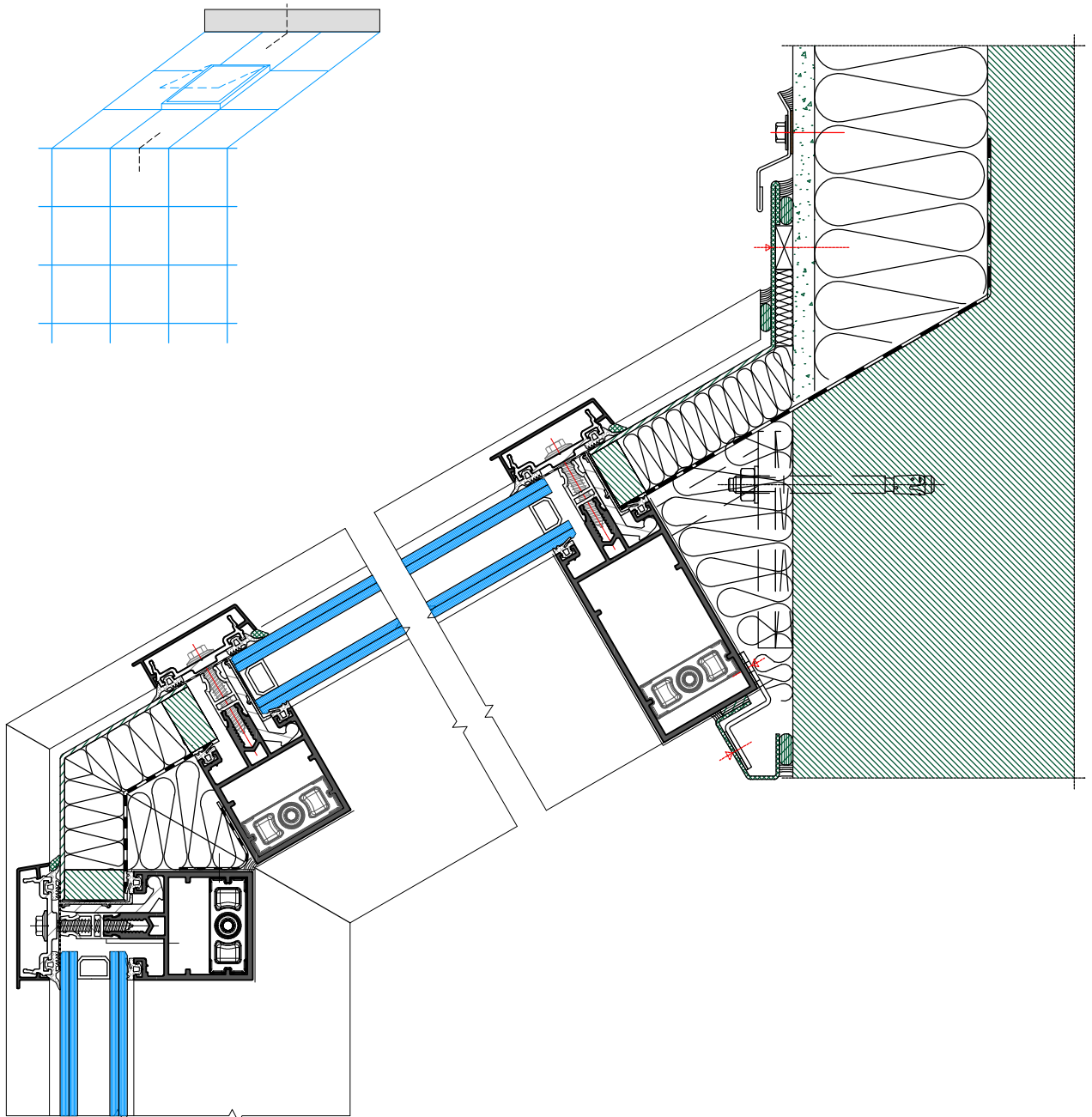



■ ESEMPI DI APPLICAZIONE

Abbaino

► *Installation Examples*
dormer window

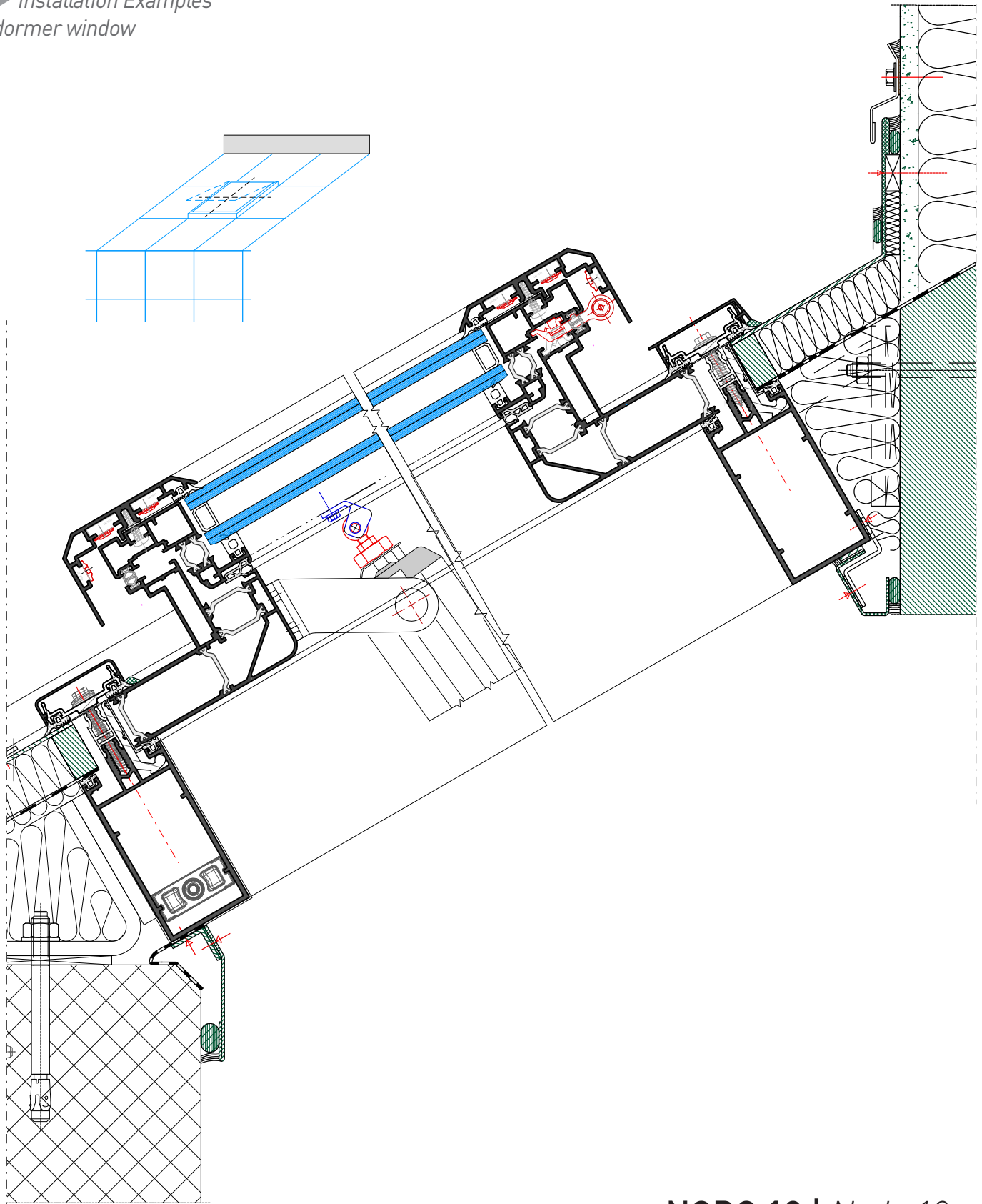

NODO 18 | Node 18



■ ESEMPI DI
APPLICAZIONE

► *Installation Examples*

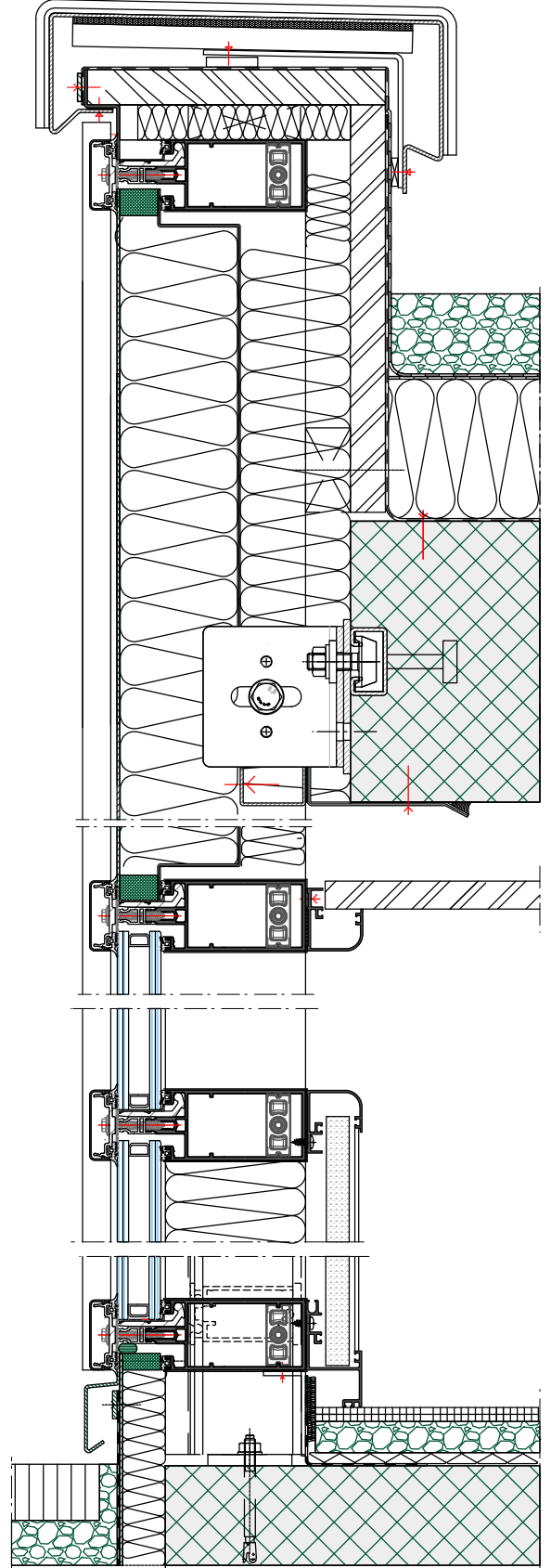
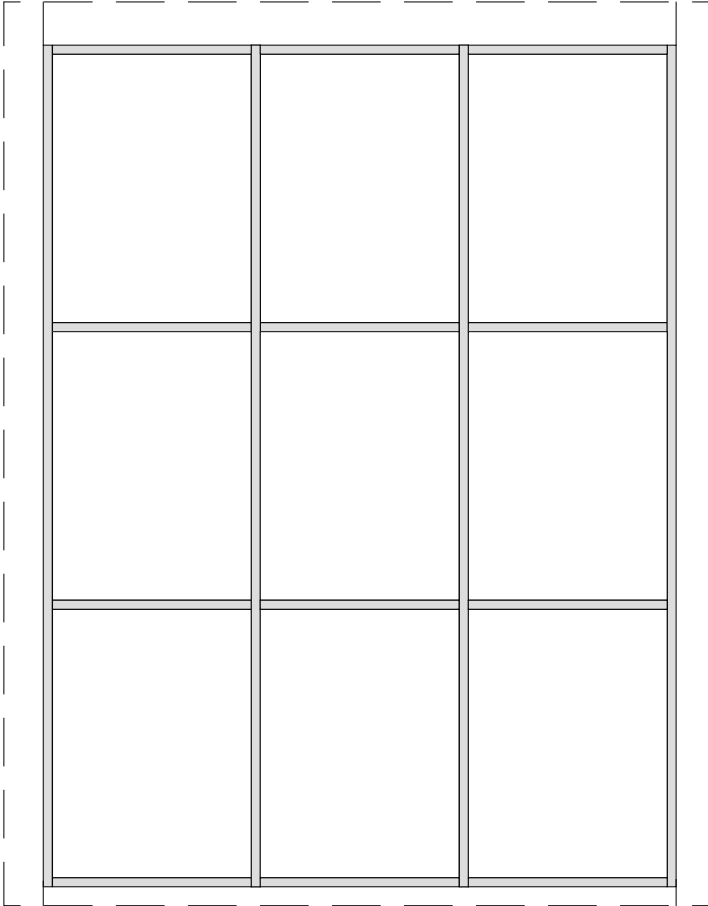

NODO 19 | Node 19

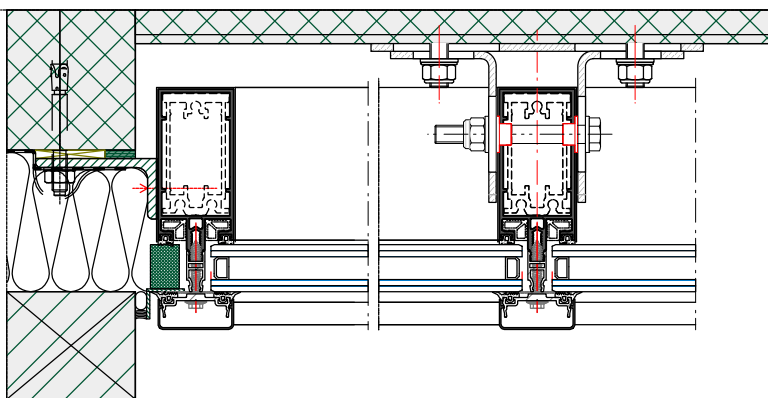



■ ESEMPI DI
APPLICAZIONE

► *Installation Examples*

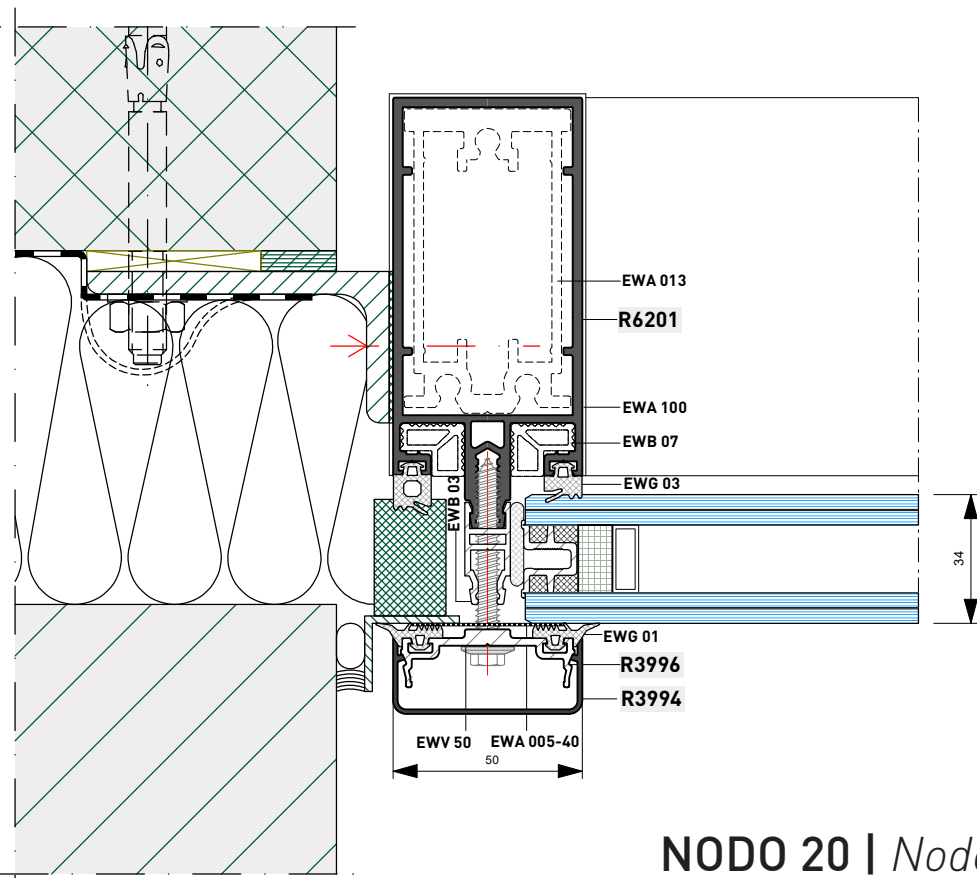

NODO 20 | Node 20

■ ESEMPI DI
APPLICAZIONE

► *Installation Examples*

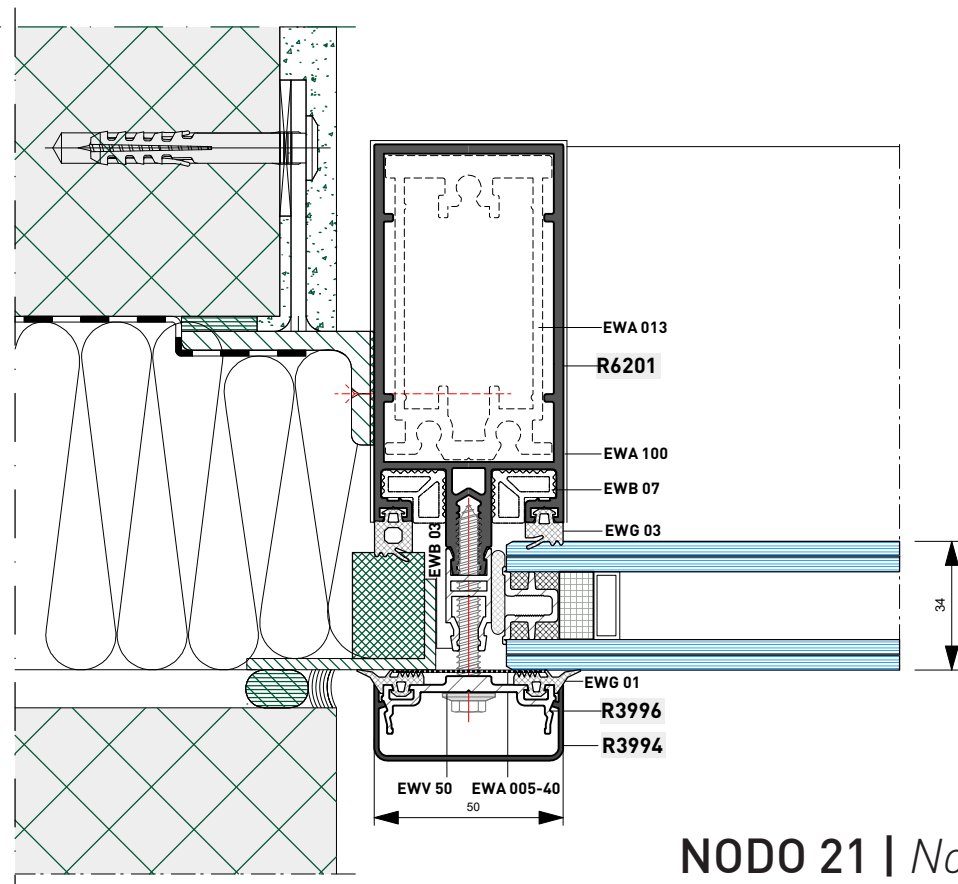

NODO 21 | Node 21



■ ESEMPI DI
APPLICAZIONE

► *Installation Examples*

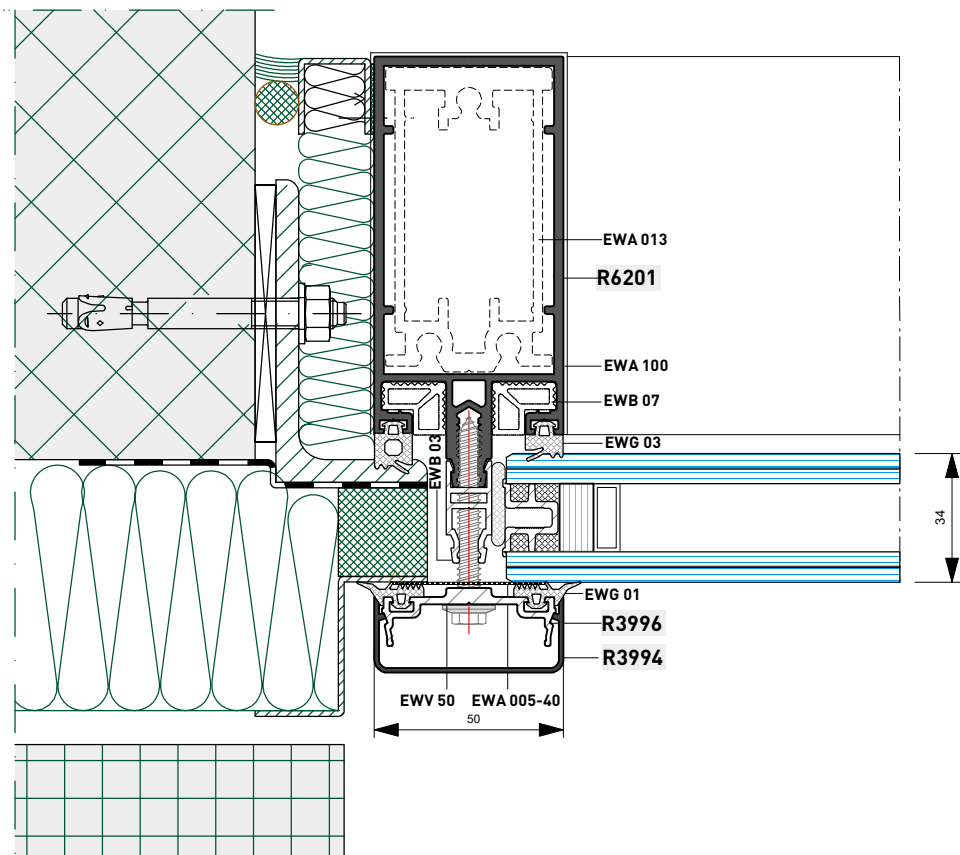

NODO 22 | Node 22

■ ESEMPI DI
APPLICAZIONE

► *Installation Examples*

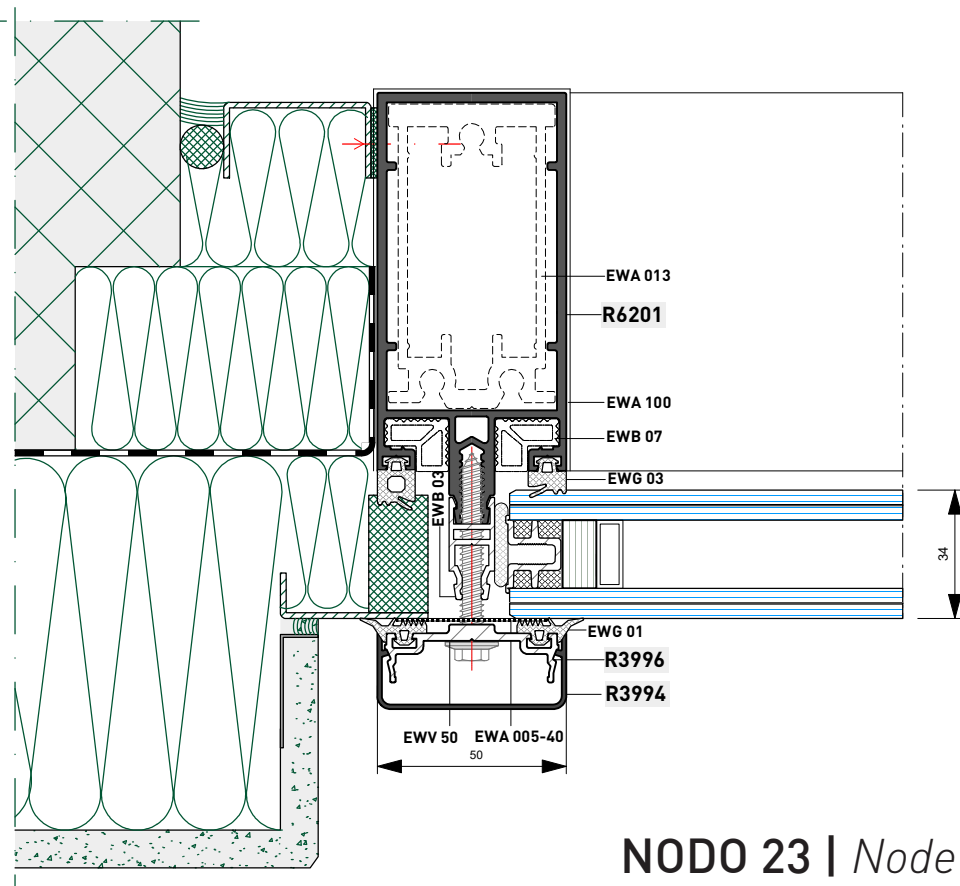

NODO 23 | Node 23



■ ESEMPI DI APPLICAZIONE

► Installation Examples

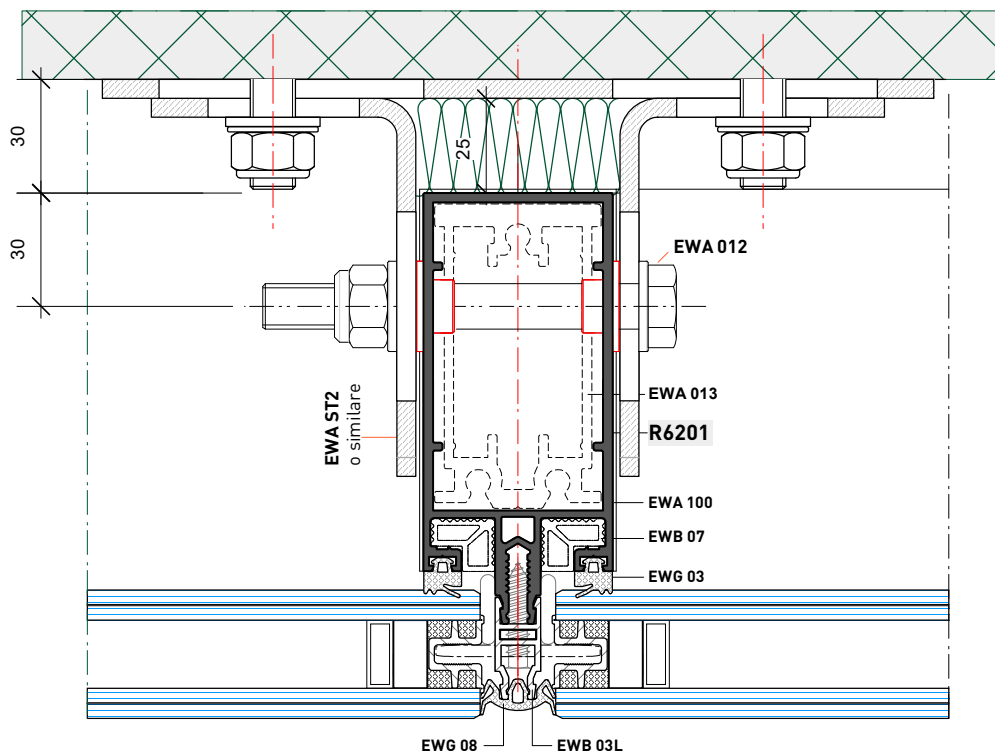

NODO 24 | Node 24

■ ESEMPI DI APPLICAZIONE

► Installation Examples

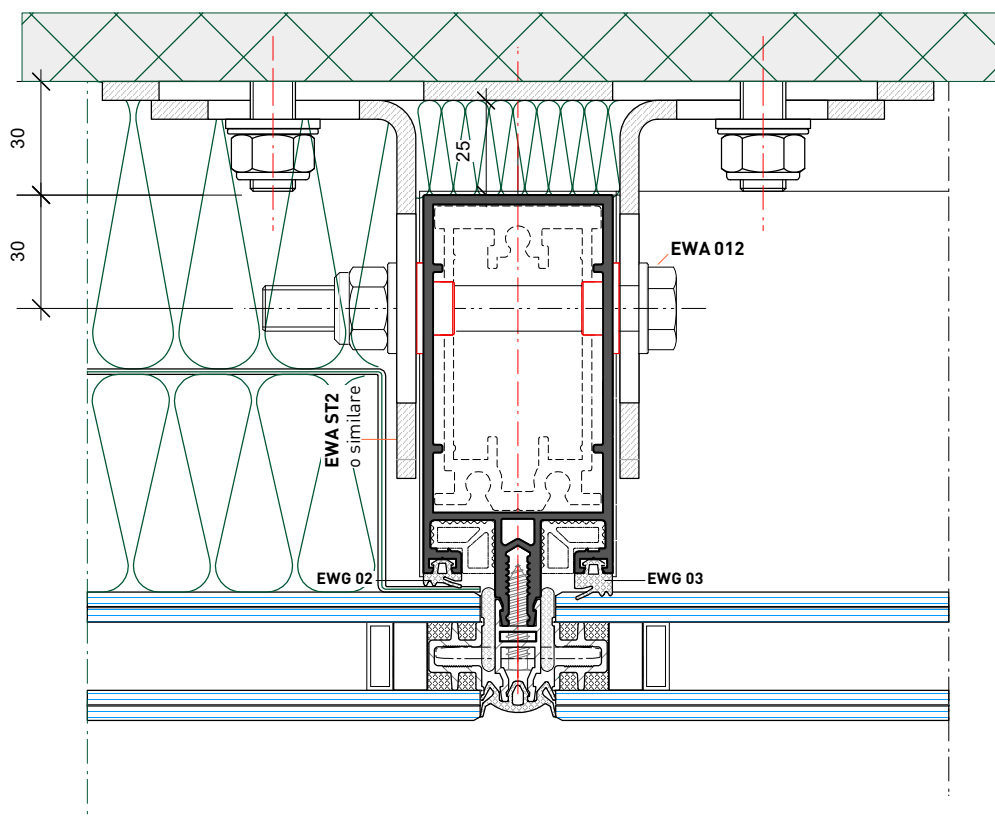

NODO 25 | Node 25



■ ESEMPI DI APPLICAZIONE

► *Installation Examples*

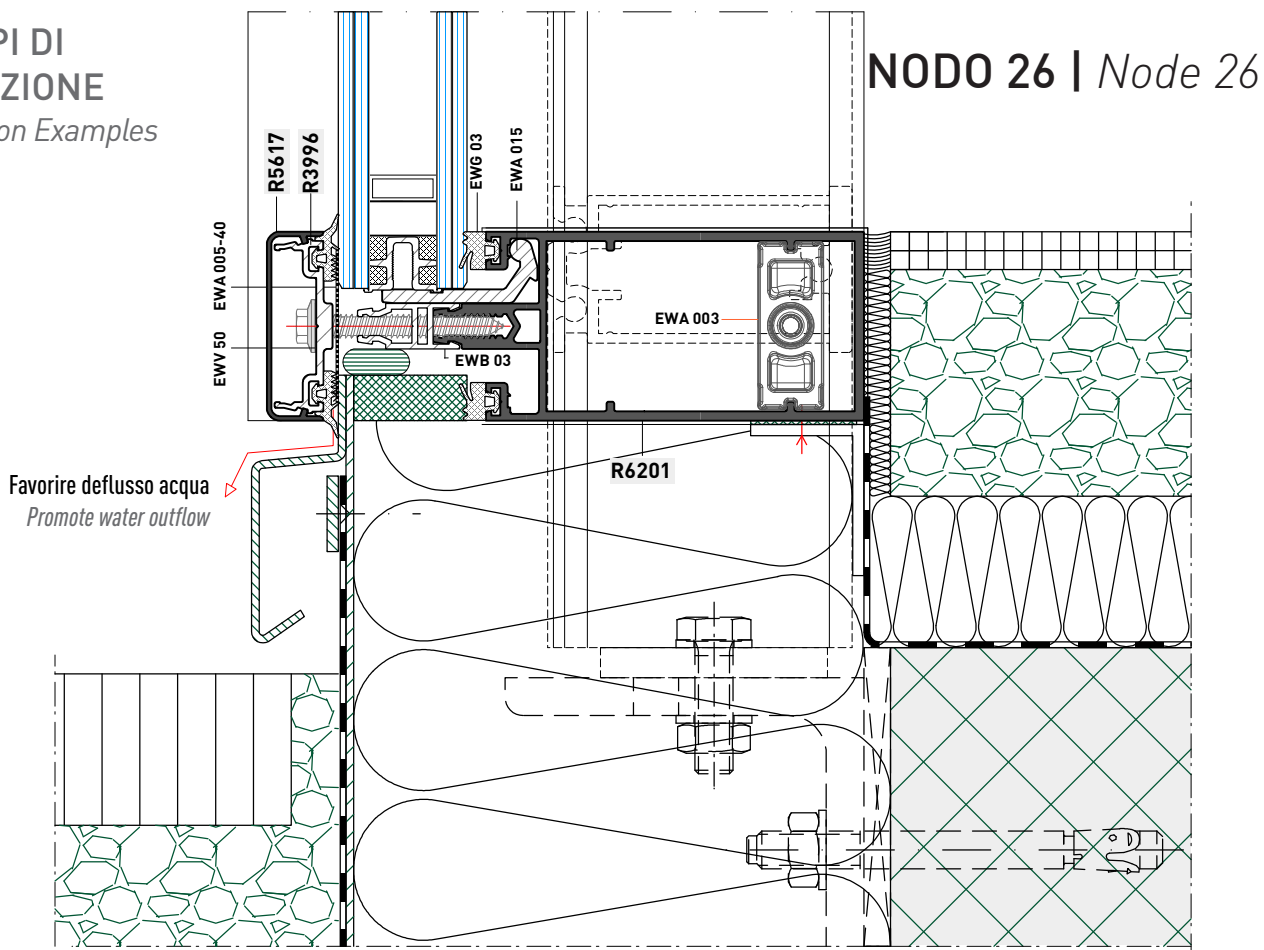

■ ESEMPI DI APPLICAZIONE

► *Application Examples*

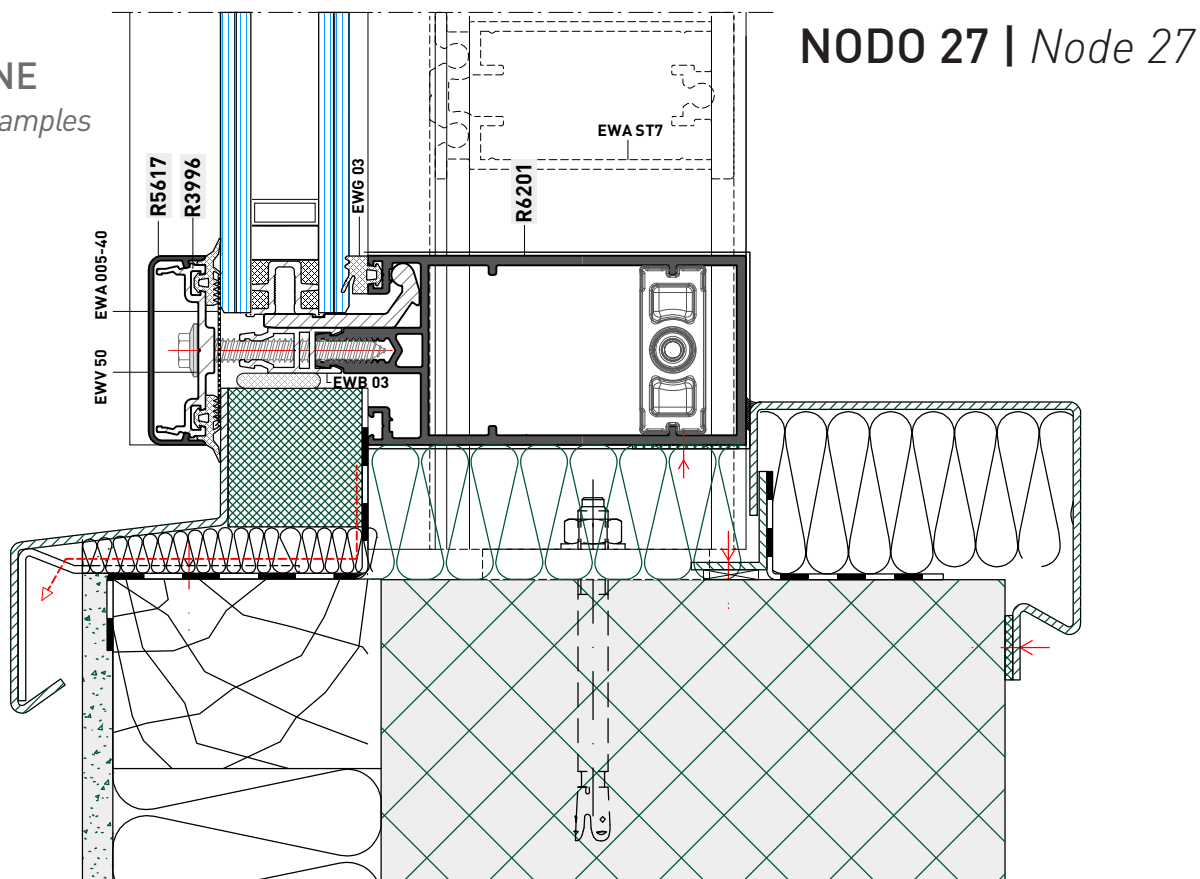



■ ESEMPI DI
APPLICAZIONE

► *Installation Examples*

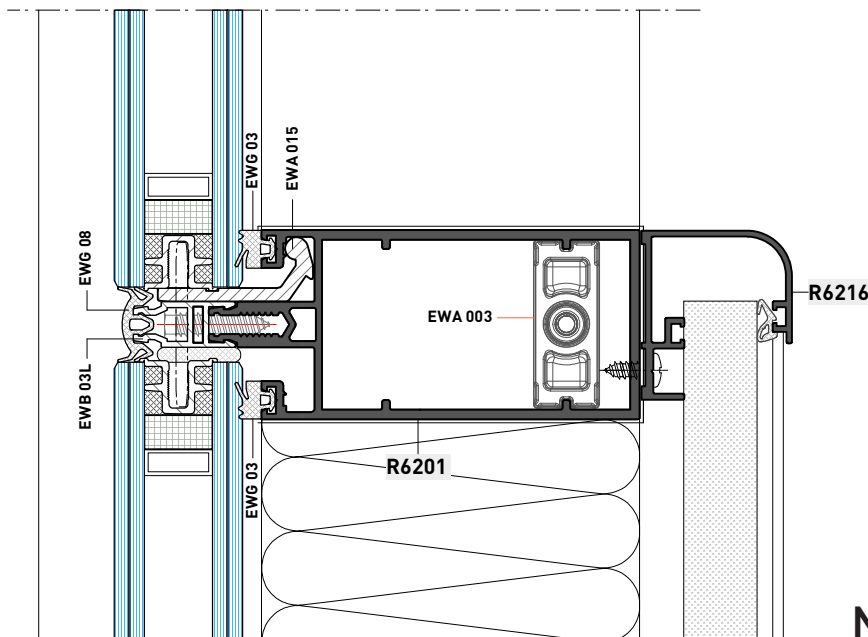

NODO 28 | Node 28

■ ESEMPI DI
APPLICAZIONE

► *Application Examples*

Variante senza tamponatura
Variant without infill

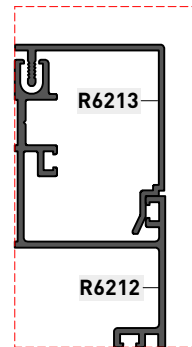
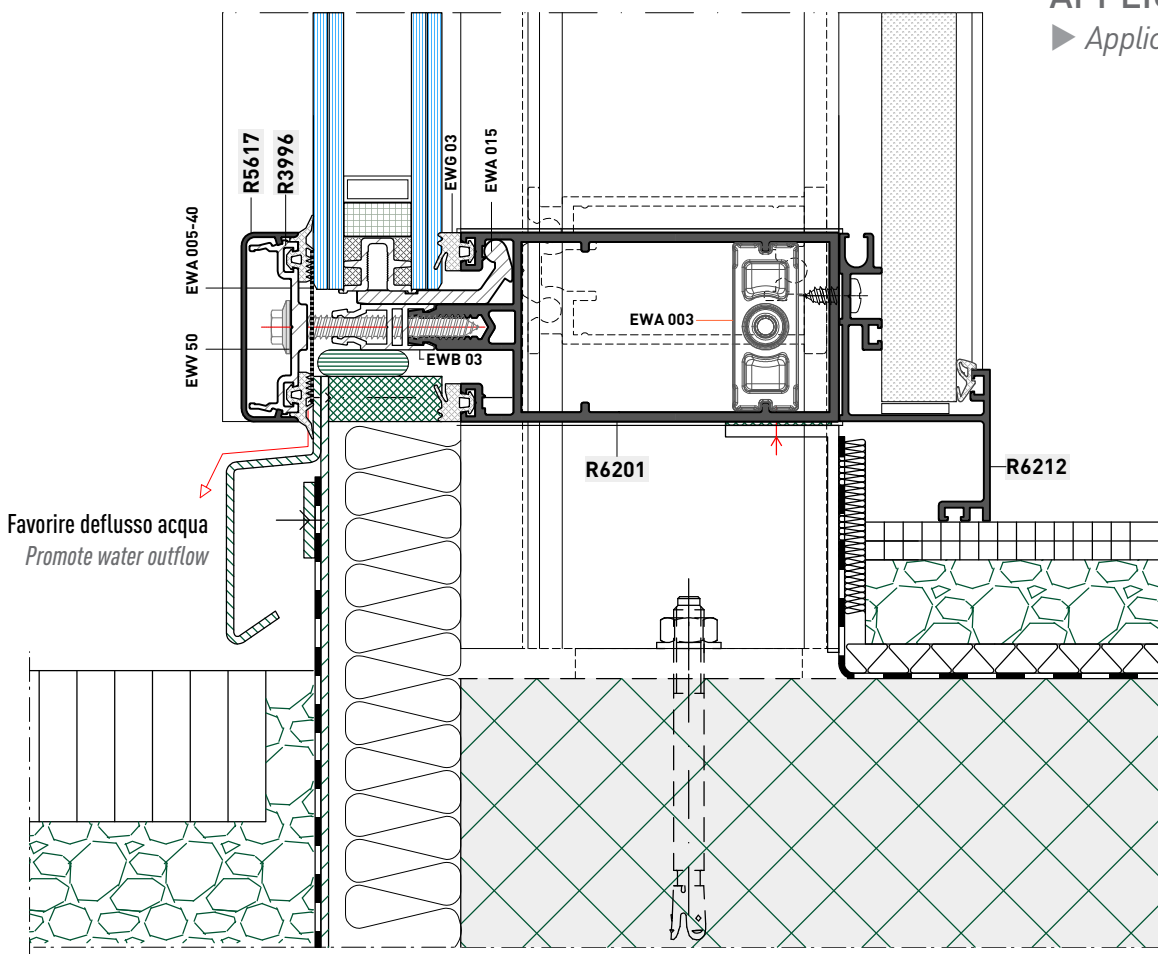

NODO 29 | Node 29



■ ESEMPI DI
APPLICAZIONE

► *Installation Examples*

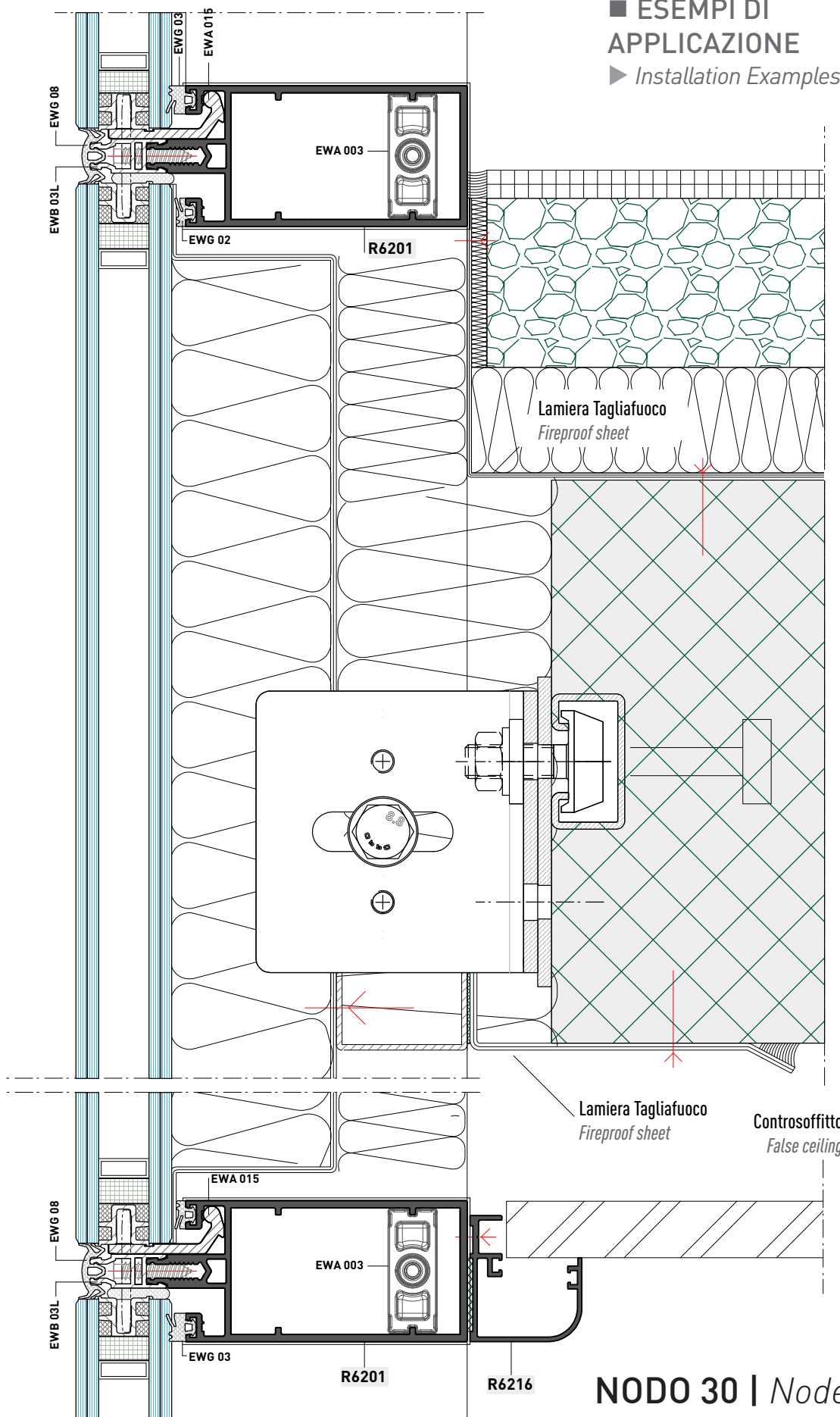

NODO 30 | Node 30



■ ESEMPI DI
APPLICAZIONE

► *Installation Examples*

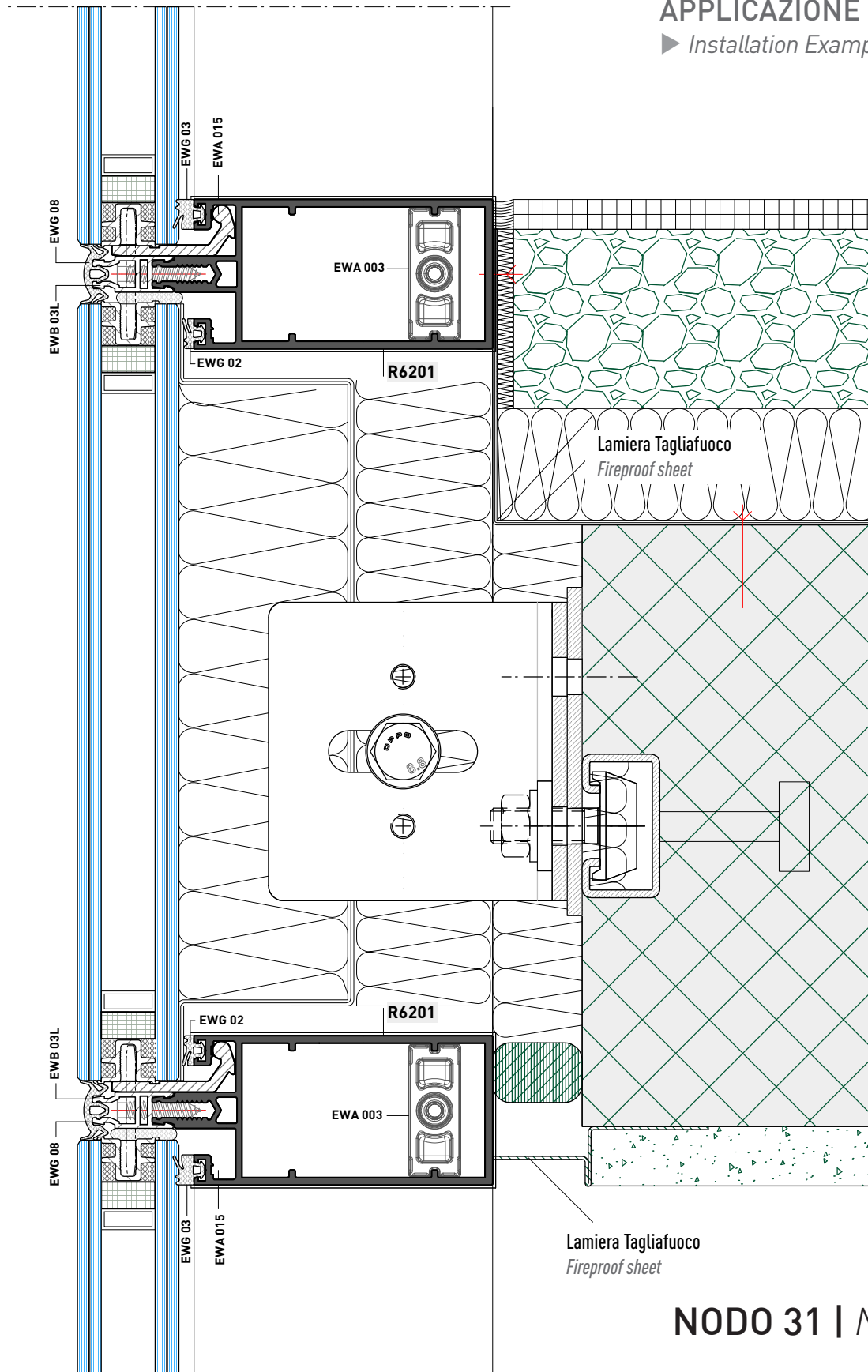

NODO 31 | Node 31



■ ESEMPI DI
APPLICAZIONE

► *Installation Examples*

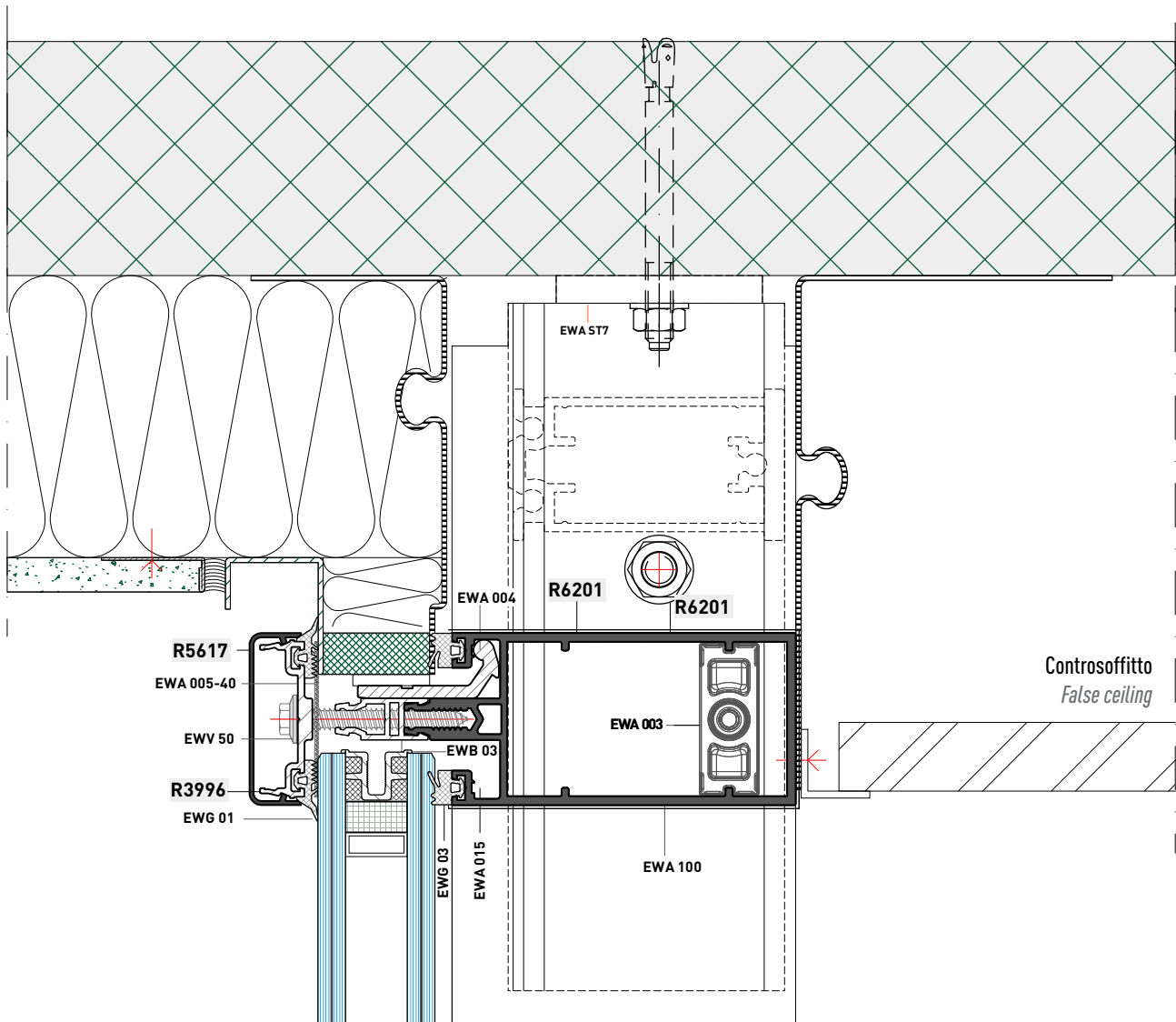

NODO 32 | Node 32



■ ESEMPI DI
APPLICAZIONE
► *Installation Examples*

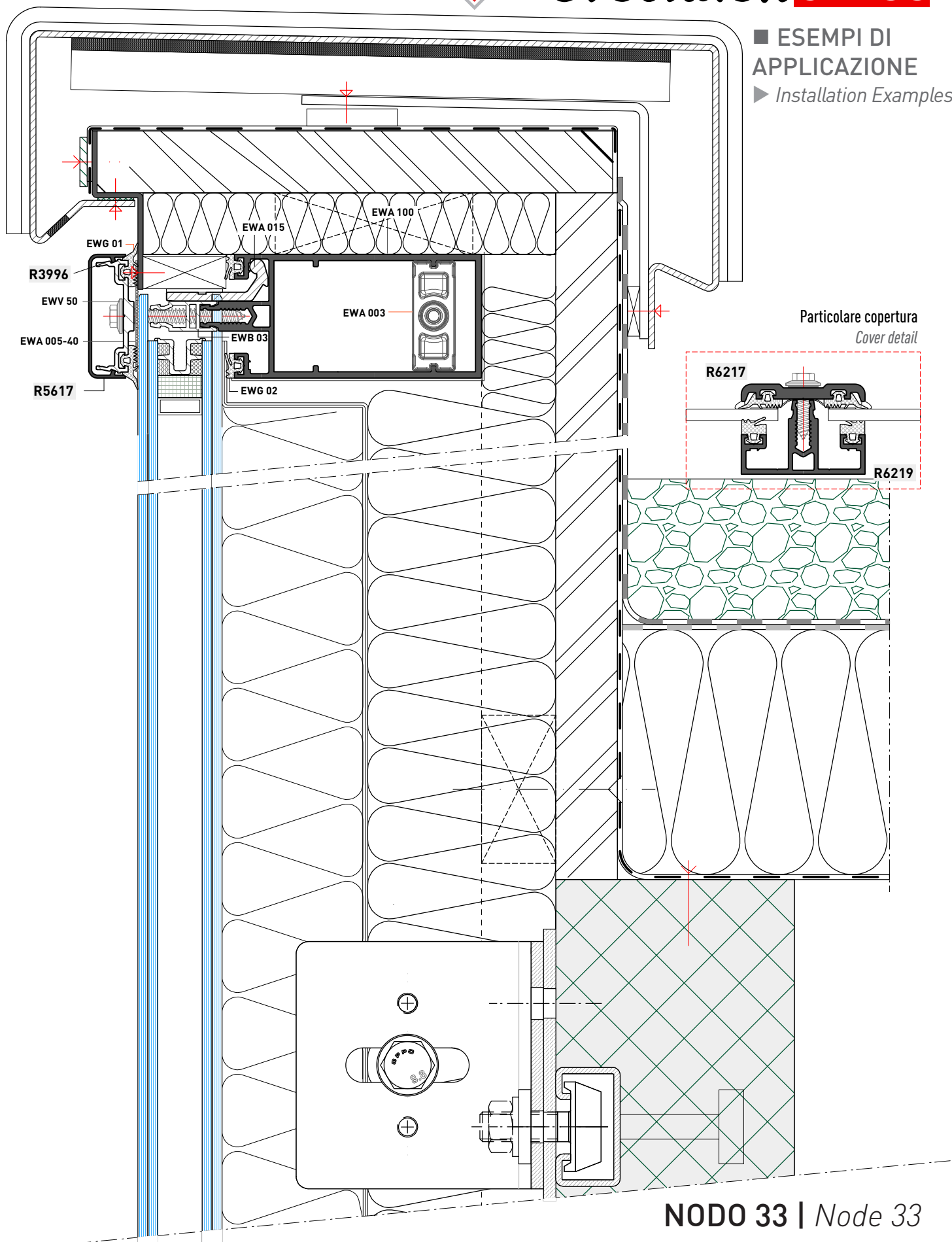

NODO 33 | Node 33



■ ESEMPI DI
APPLICAZIONE

► *Installation Examples*

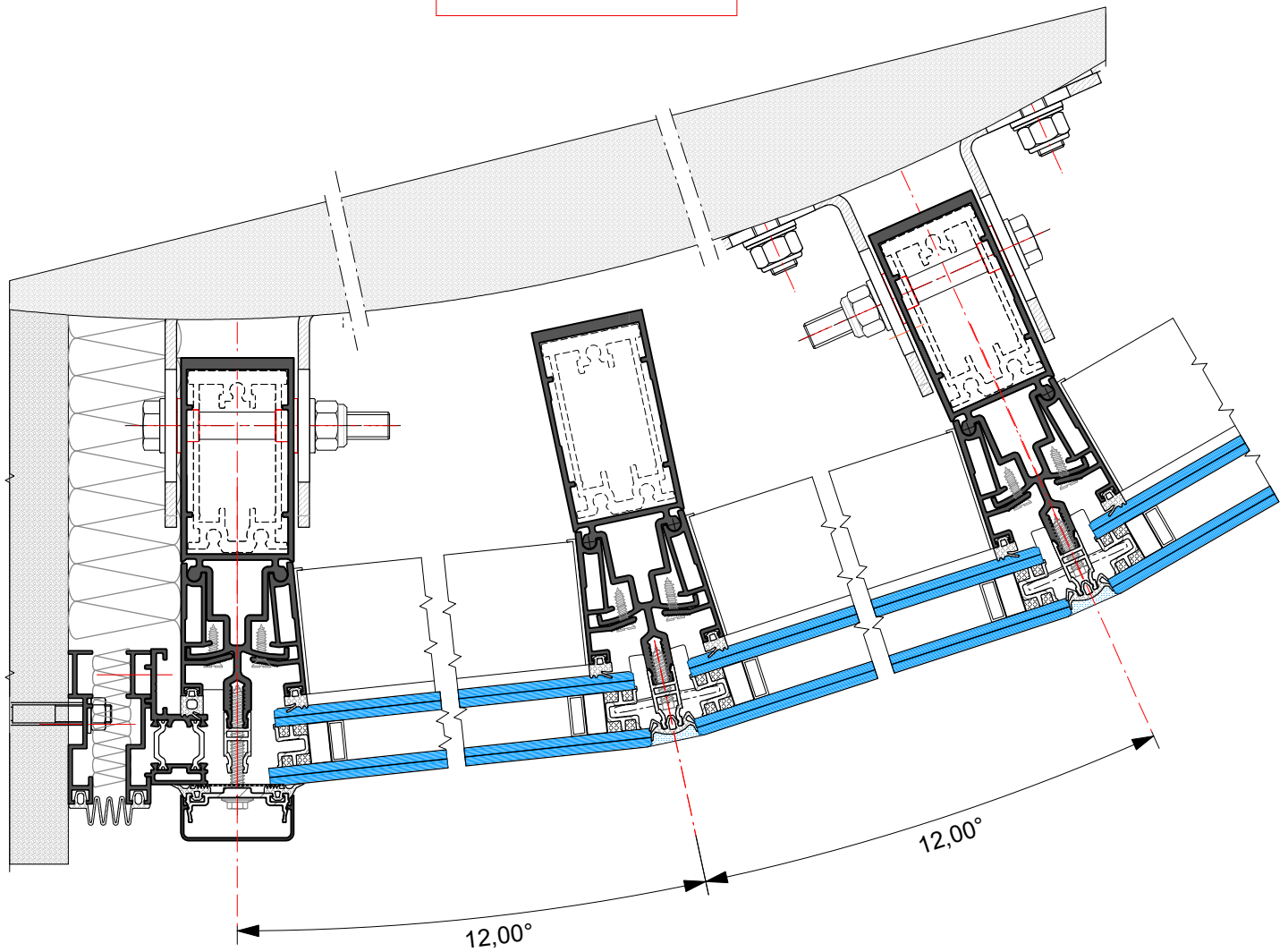
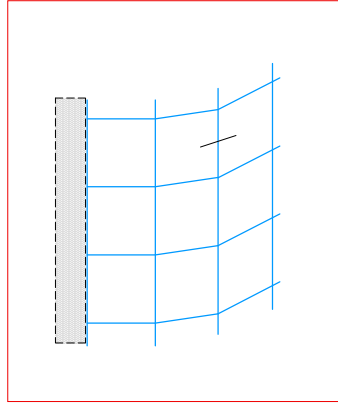

NODO 34 | Node 34



- ESEMPI DI APPLICAZIONE Facciata inclinata
- Installation Examples Inclined facade

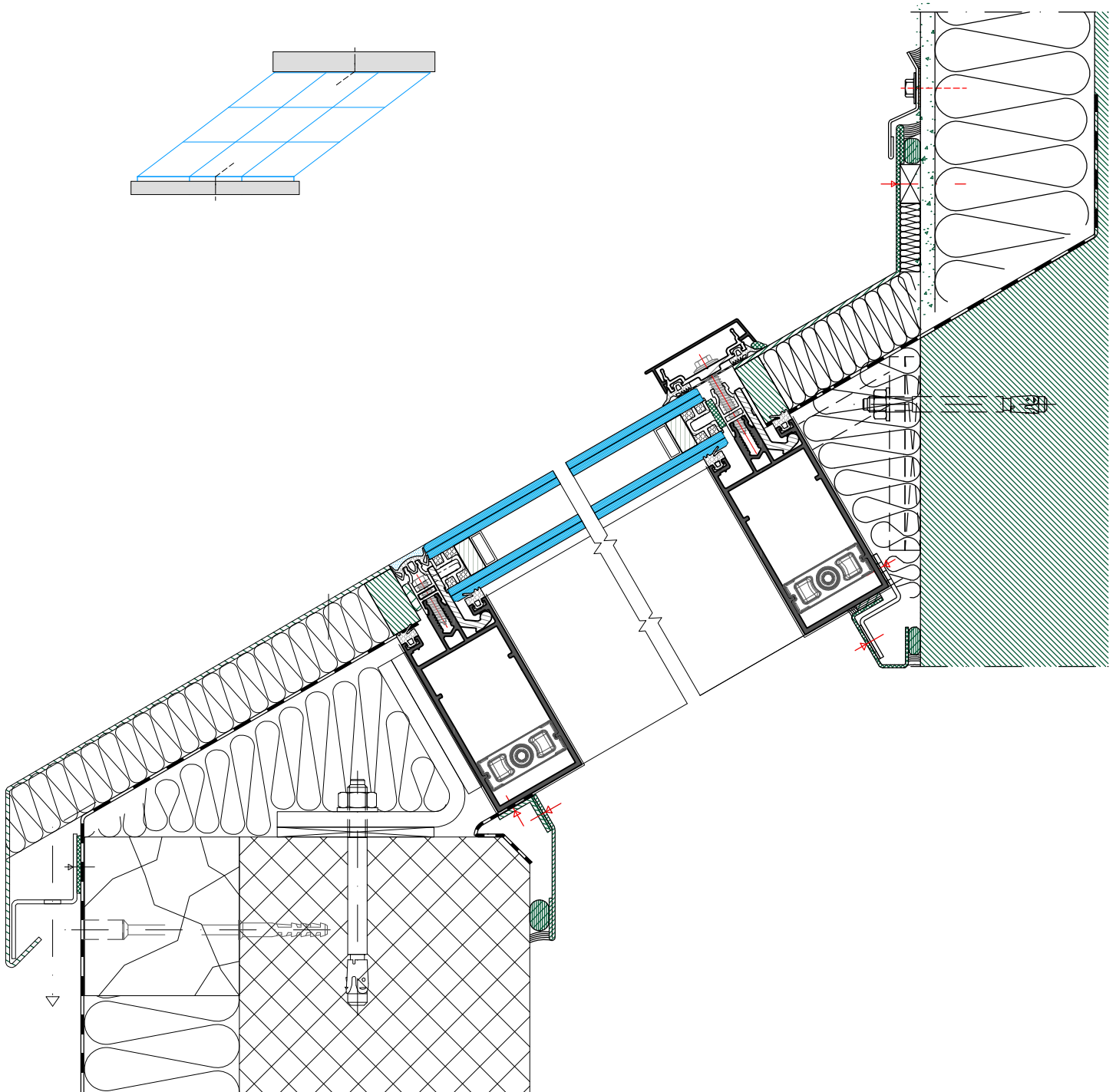

NODO 35 | Node 35



■ **ESEMPI DI APPLICAZIONE** Facciata inclinata

► *Installation Examples Inclined facade*

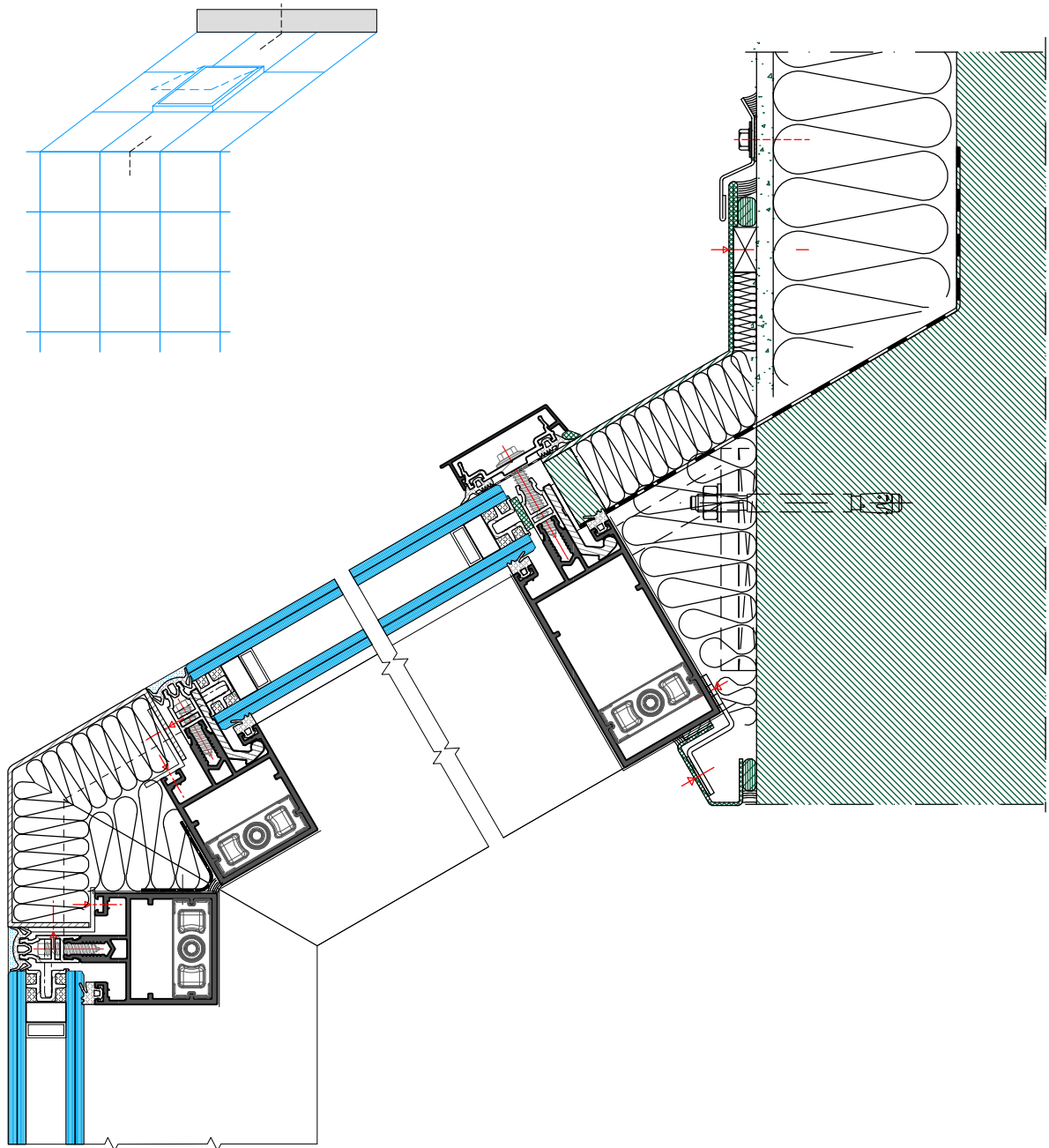

NODO 36 | *Node 36*



■ ESEMPI DI APPLICAZIONE

► *Installation Examples*

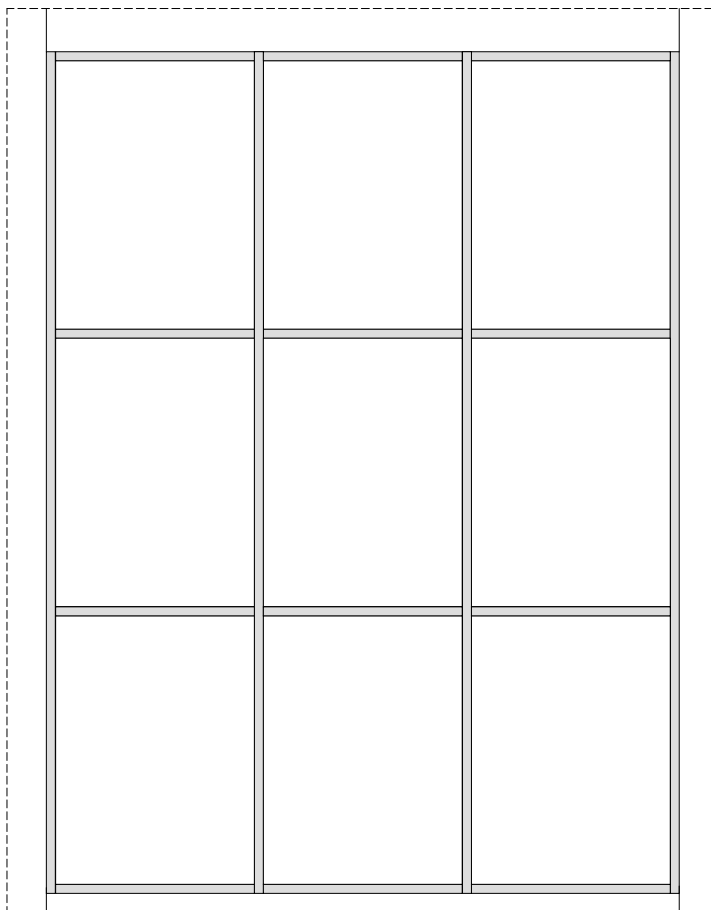

NODO 37 | *Node 37*

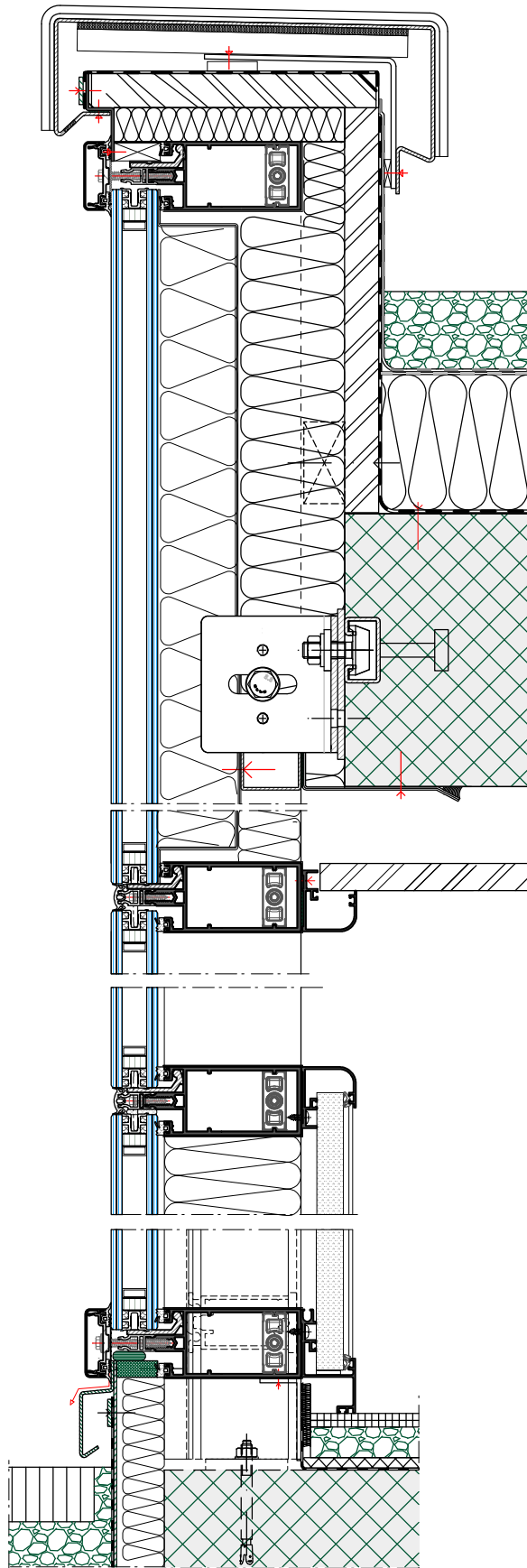
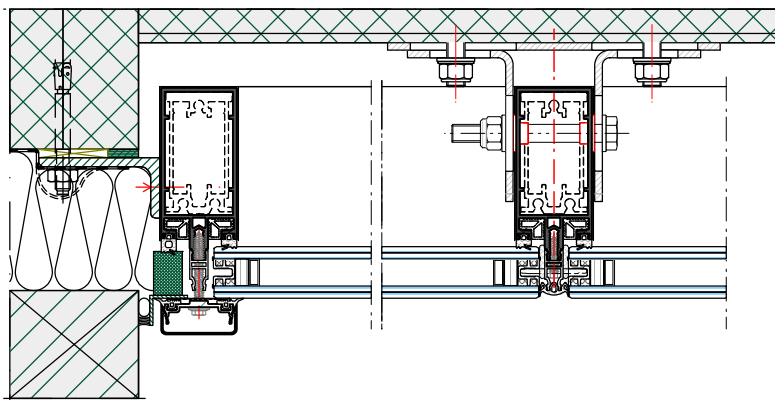

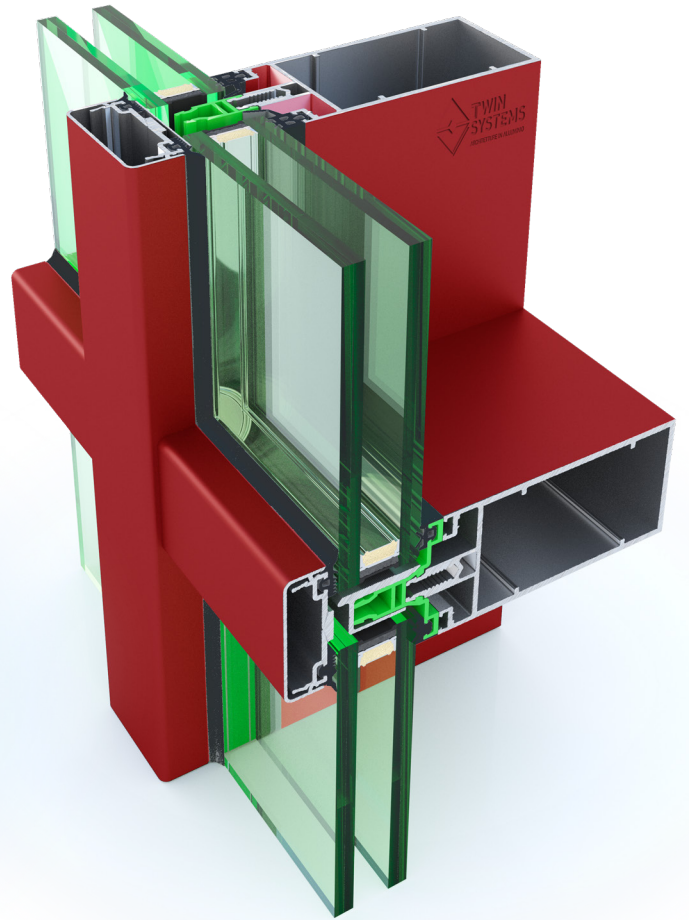
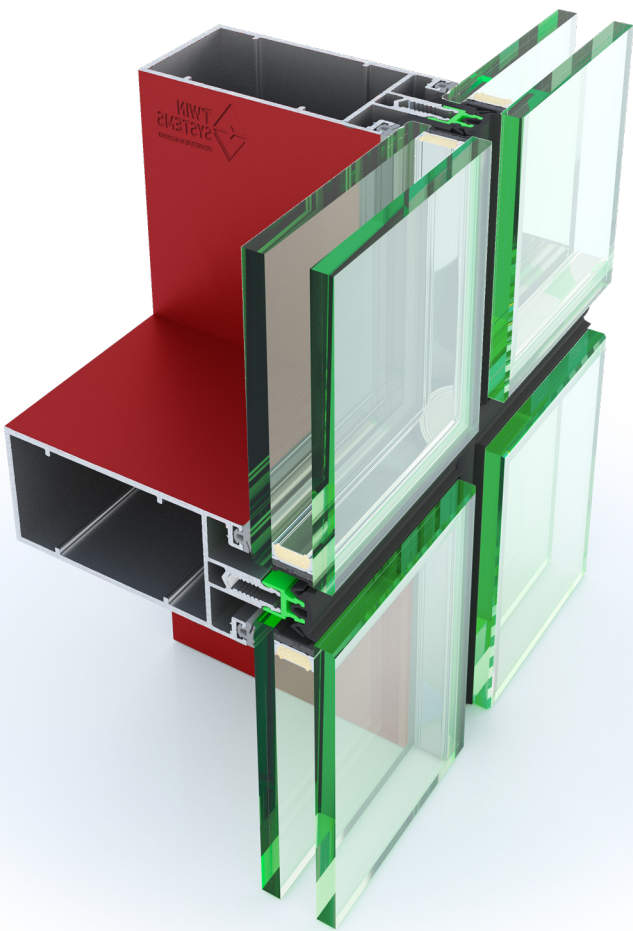

Evolution **GLASS**

Evolution

Lavorazioni e Montaggi
Tooling and Assembly

Gruppo **G**

Schemi Lavorazioni
Frese
Attrezzatura

*Tooling Systems
Cutters Equipments
Milling*



COLLEGAMENTO A SOFFITTO E PAVIMENTO NASCOSTO
CONCEALED CEILING AND FLOOR CONNECTION

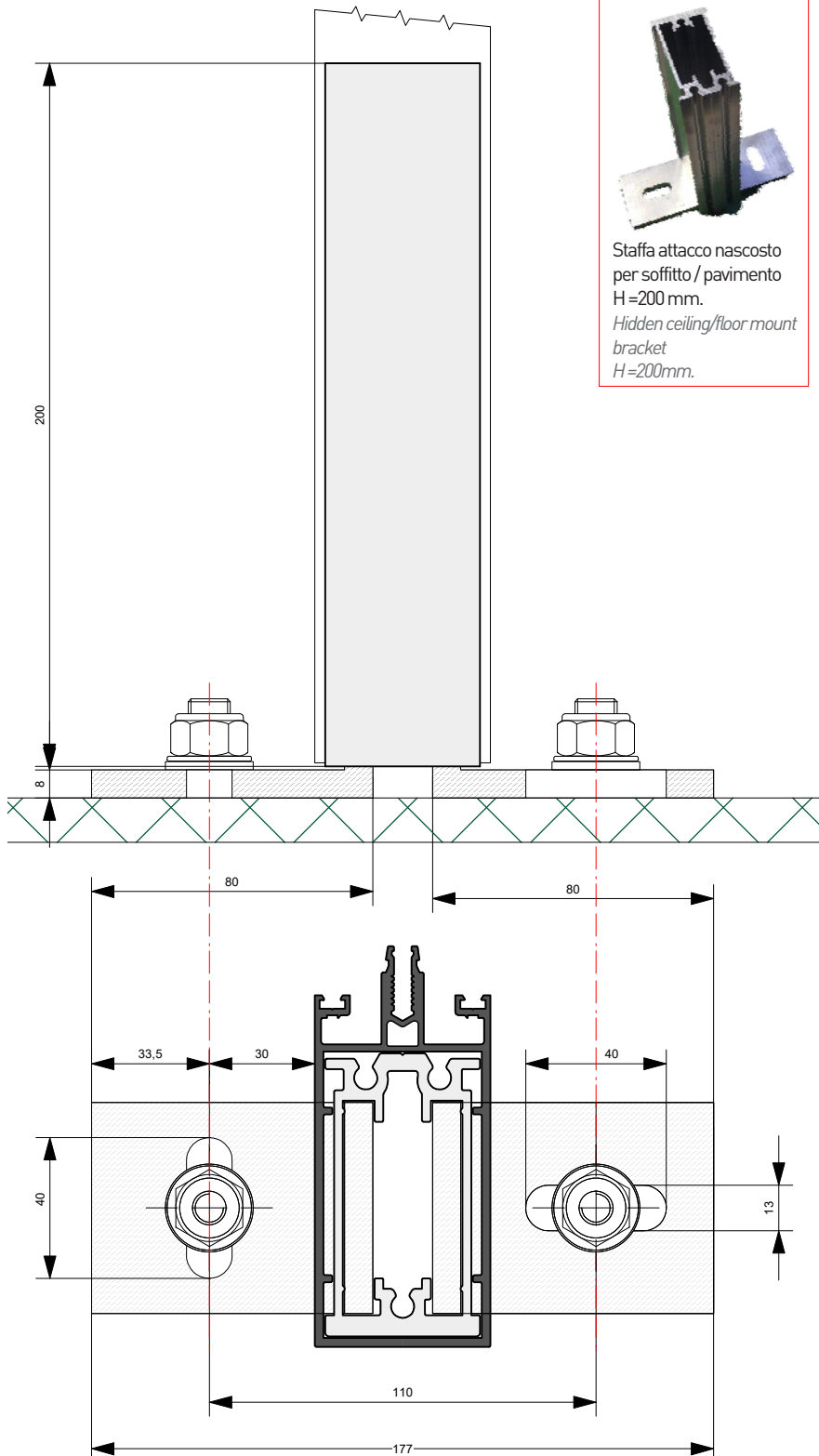

EWA.ST7

Staffa attacco nascosto per soffitto / pavimento H=200 mm.
Hidden ceiling/floor mount bracket H=200mm.

Lavorazione staffe | Stirrup processing



COLLEGAMENTO MONTANTI STAFFA E CANOTTO
CONNECTION OF BRACKET UPRIGHTS AND STEERING COLUMN

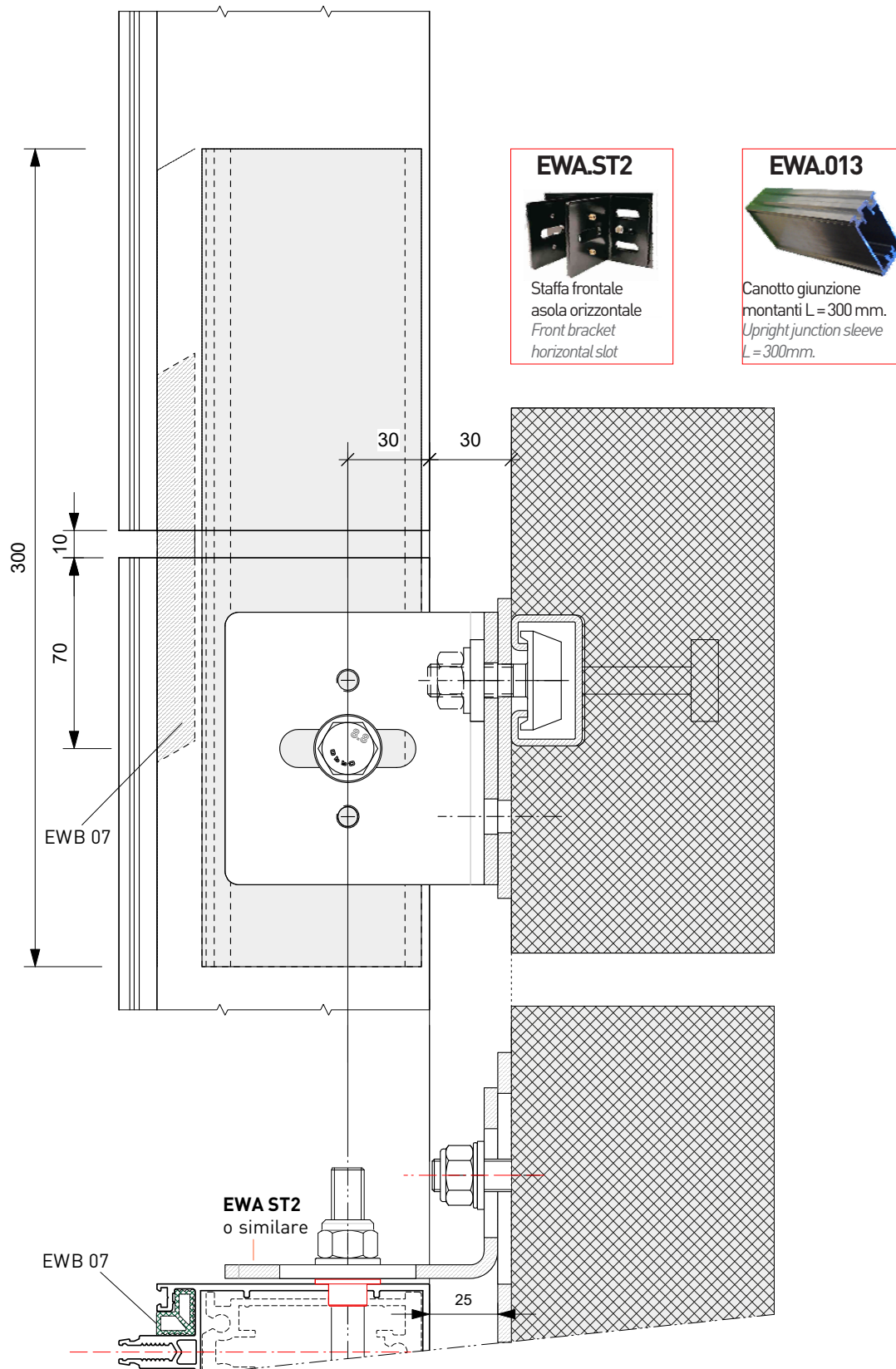

COLLEGAMENTO MONTANTI STAFFA E CANOTTO

CONNECTION OF BRACKET UPRIGHTS AND STEERING COLUMN

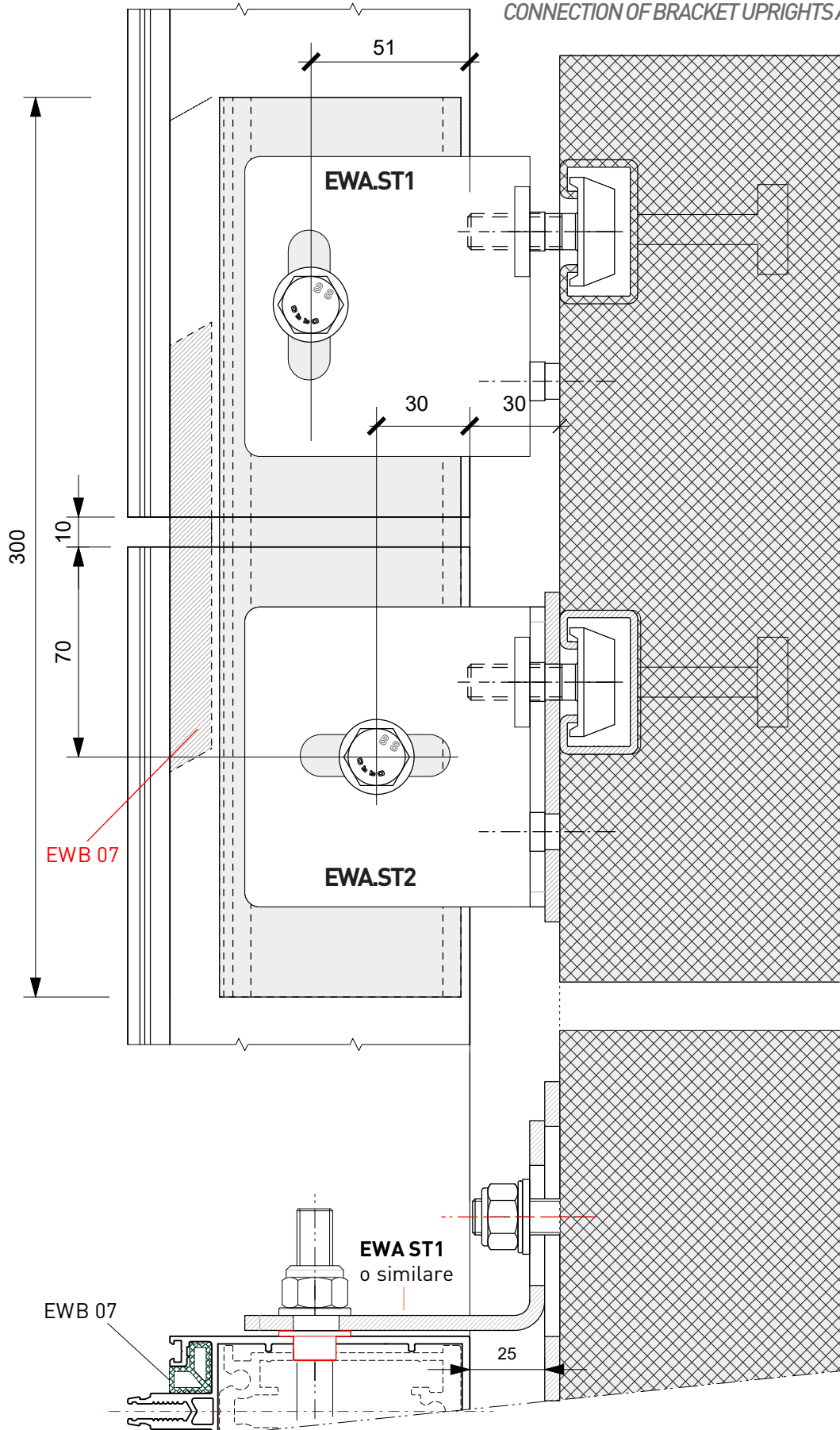

EWA.013

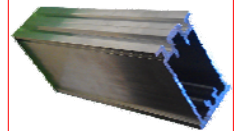

Canotto giunzione
montanti L = 300 mm.
*Upright junction sleeve
L = 300mm.*

EWA.ST1



Staffa frontale
asola verticale
*Front bracket
vertical slot*

EWA.ST2

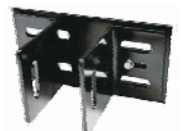

Staffa frontale
asola orizzontale
*Front bracket
horizontal slot*



Evolution

LAVORAZIONE PER DISTANZIATORE IN POLIAMMIDE BX34
JOINT MACHINING FOR BX34 POLYAMIDE SPACER

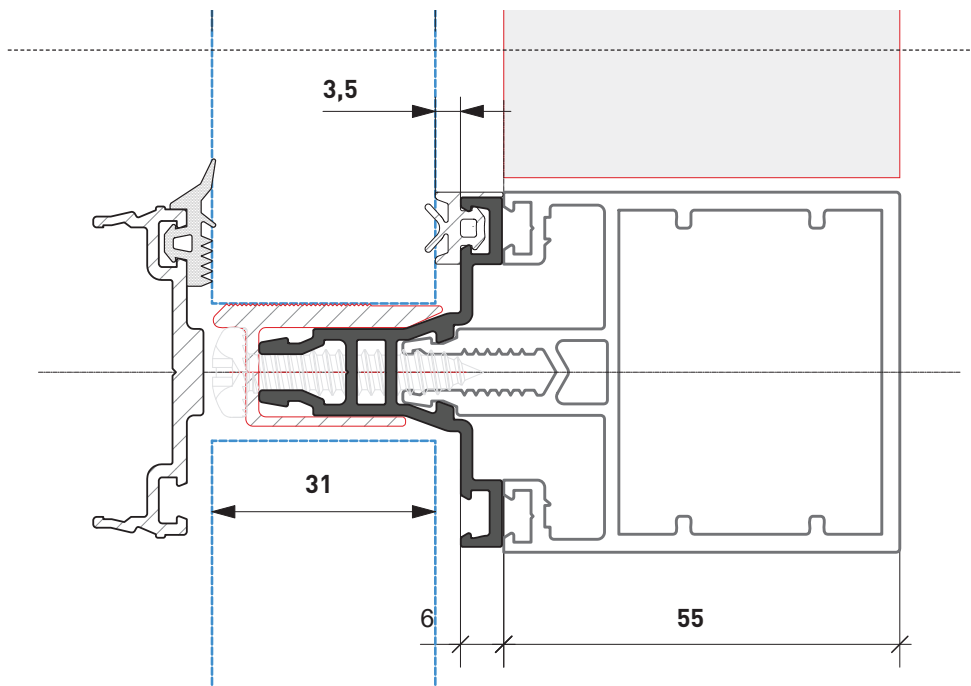

Sezione TRAVERSO

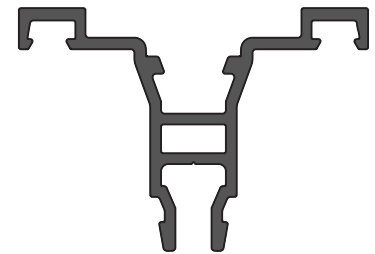

BX 34



EWG 012

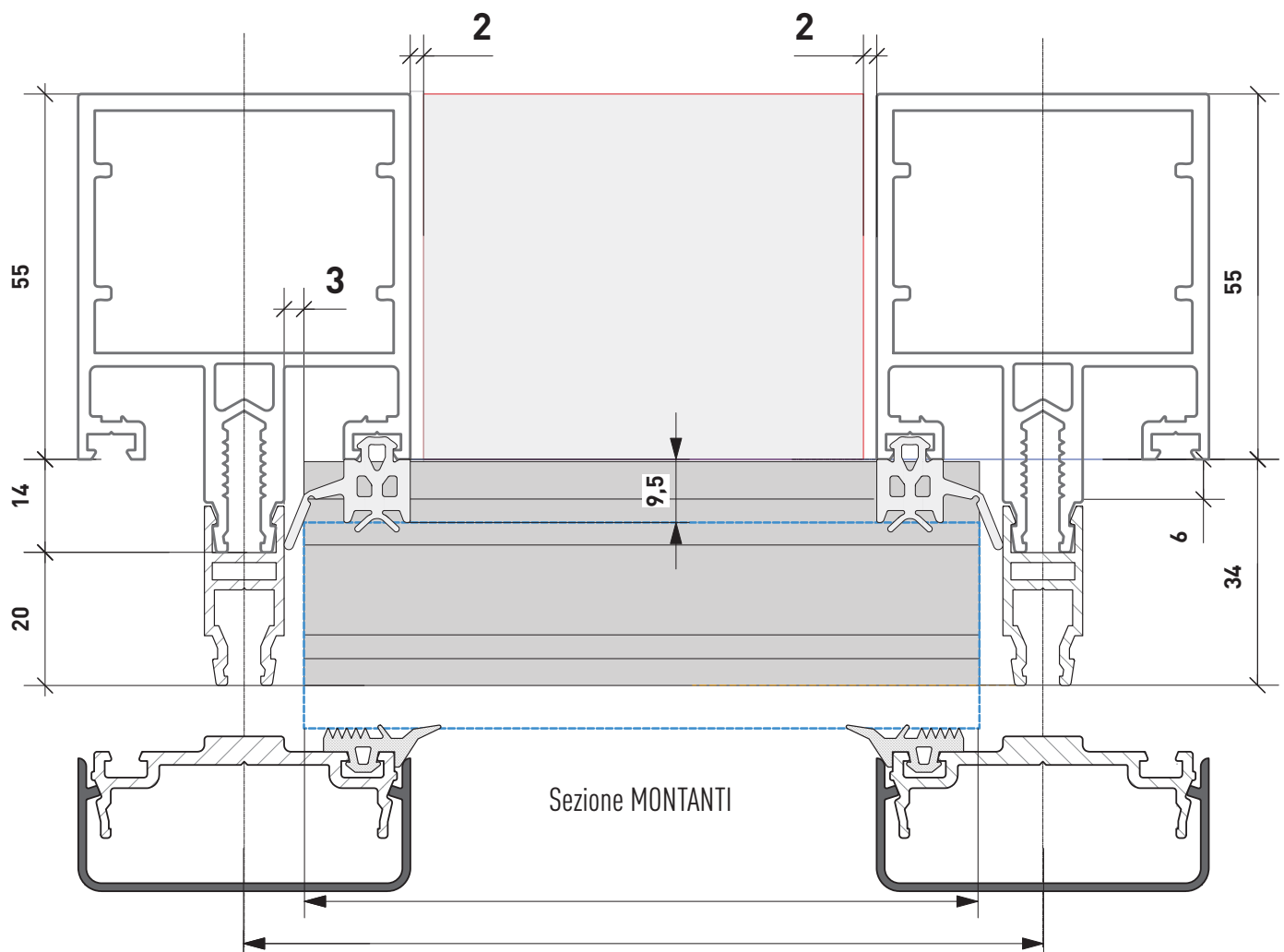

Sezione MONTANTI



Evolution

LAVORAZIONE CAVALLOTTO EWA.011 CON L'UTILIZZO DI EWA.01 E EWA.03

JOINT MACHINING EWA.011 WITH THE USE OF EWA.01 AND EWA.03

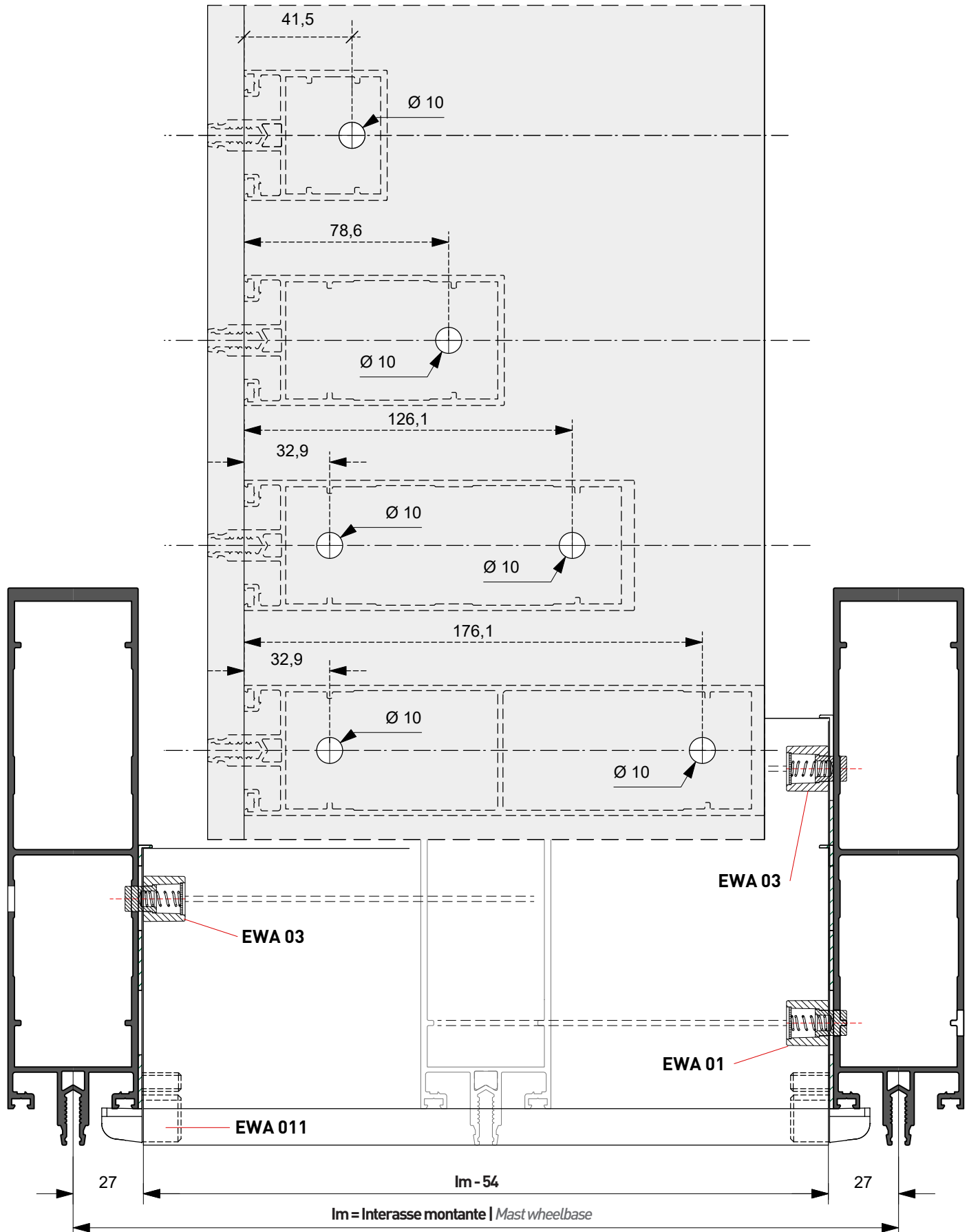



ASSEMBLAGGIO MONTANTE/TRAVERSO con EWA011
UPRIGHT/CROSSPIECE ASSEMBLY with EWA011

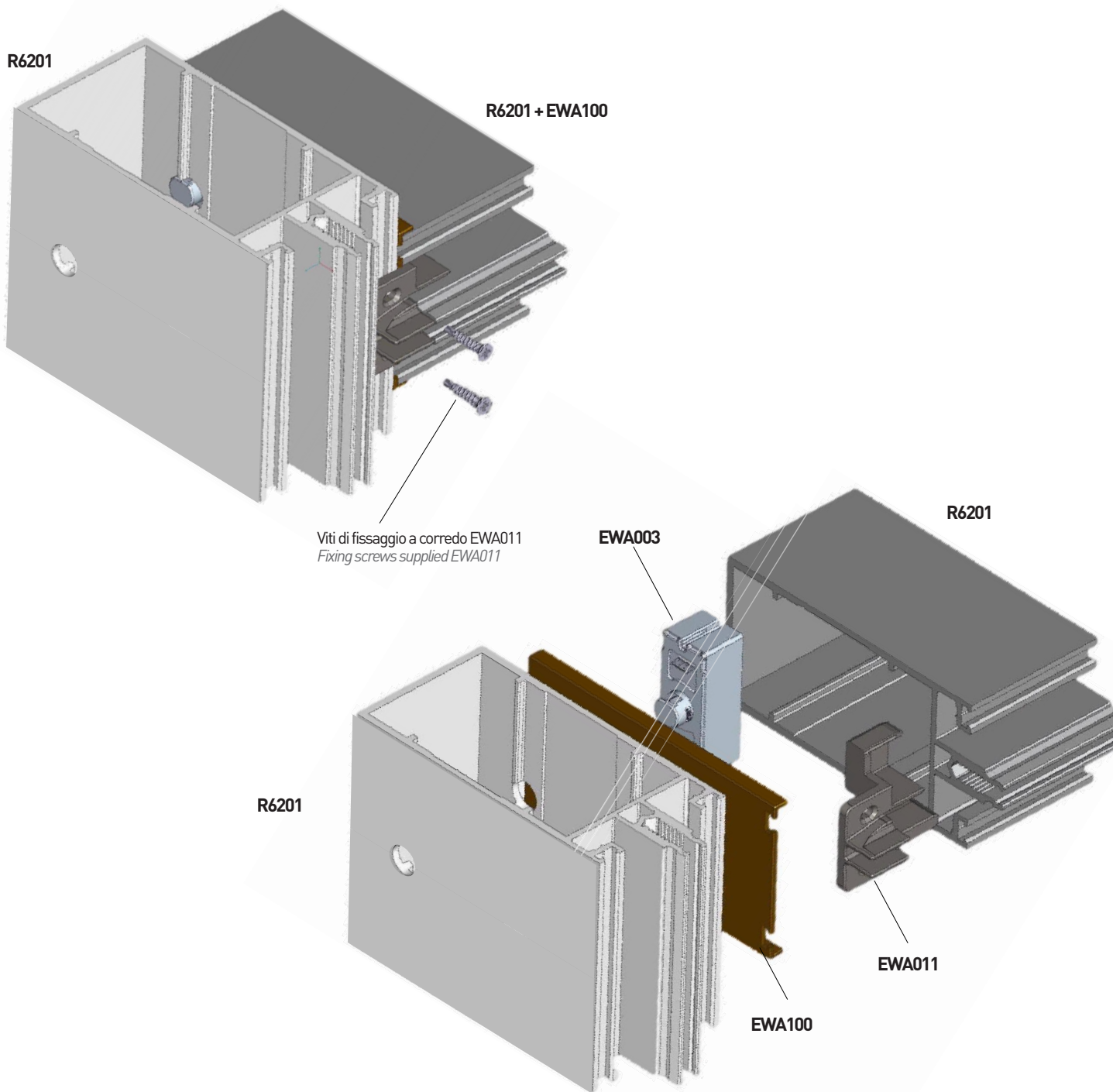



Evolution

INSTALLAZIONE EWA021 *EWA021 INSTALLING*

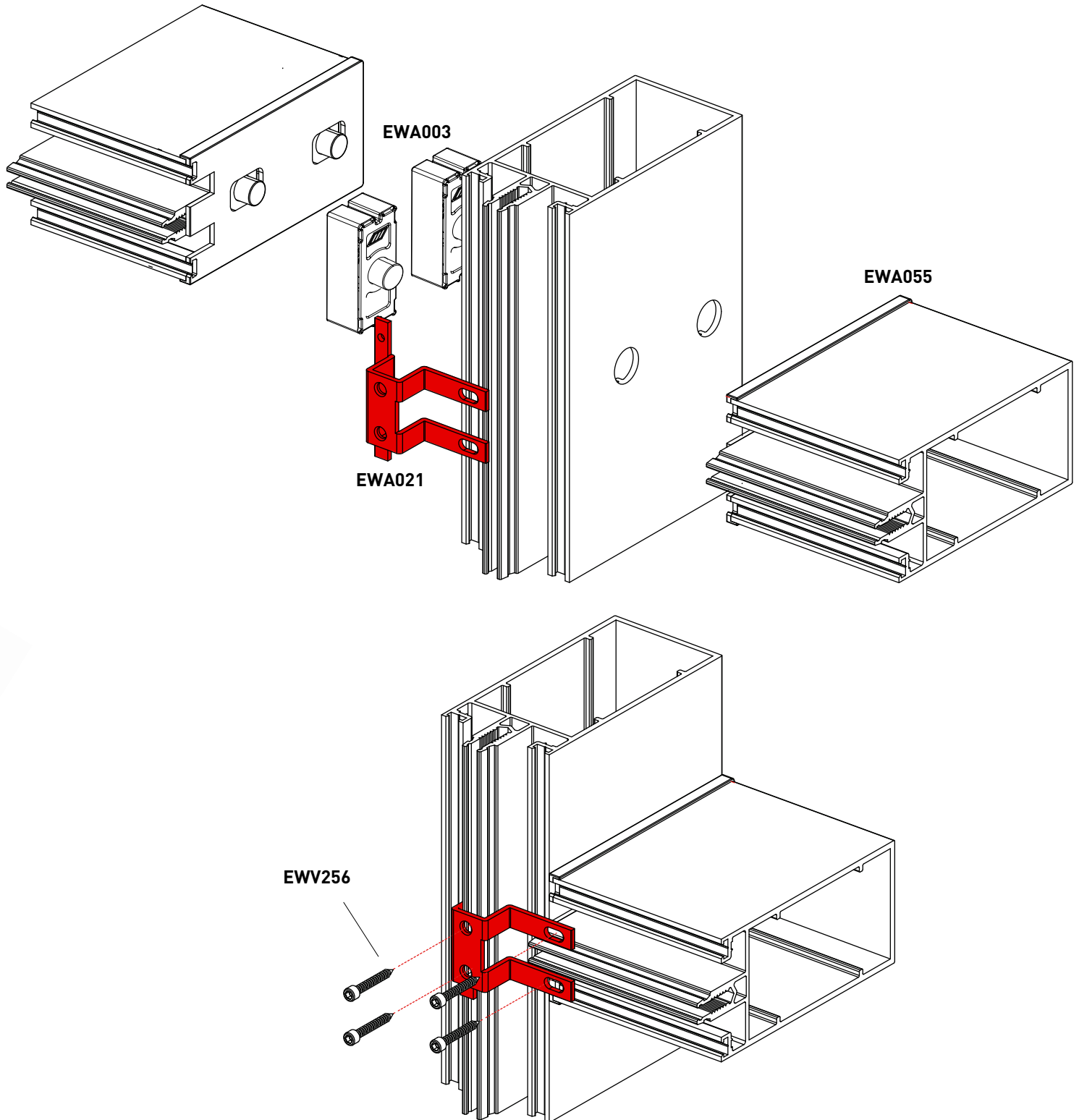



Evolution

LAVORAZIONE TAGLIO TRAVERSO E DISTANZIALE *CROSS CUT AND SPACER PROCESSING*

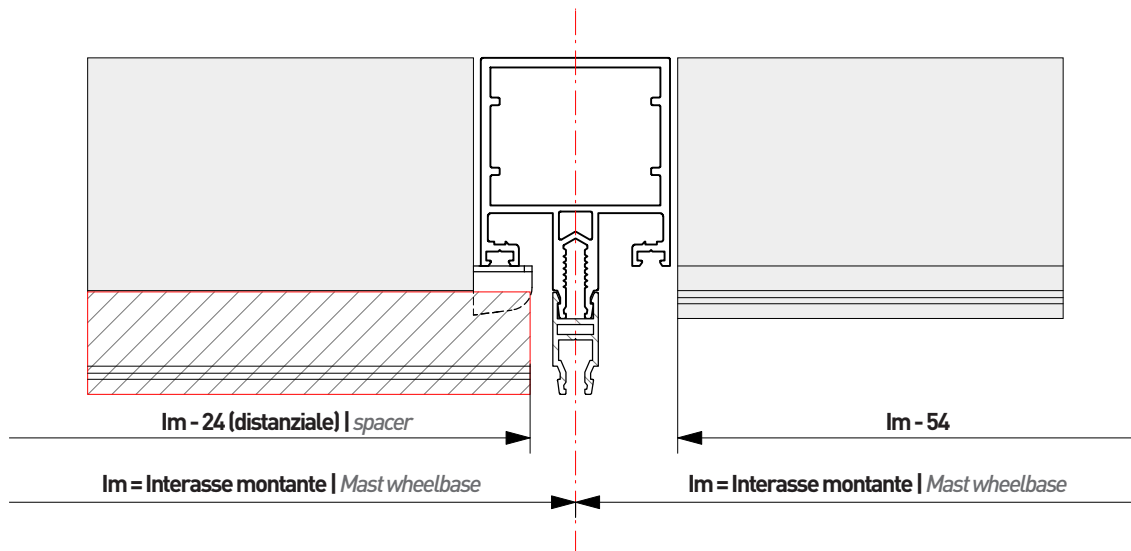

LAVORAZIONI PRESSORI *PRESSURE WORKINGS*

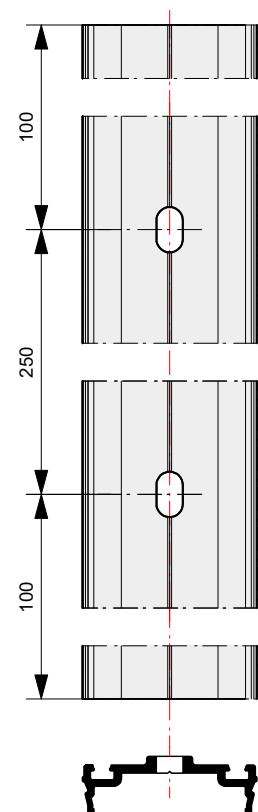
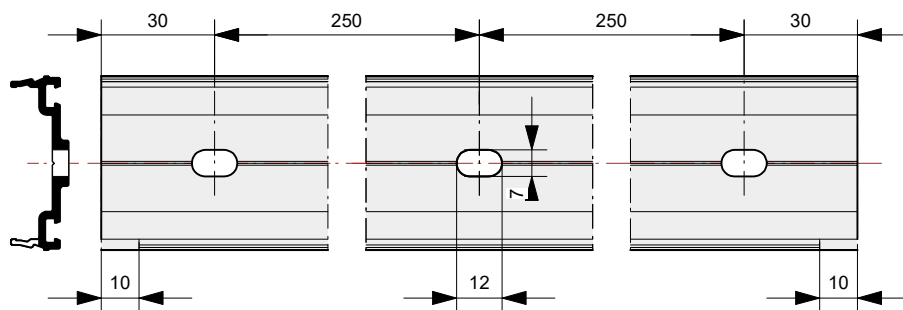

Evolution

Fase 1

Assemblaggio TRAVERSI
su MONTANTI
*Assembly of TRANSOMS on
MULLION*

R6201 | R6202 | R6203

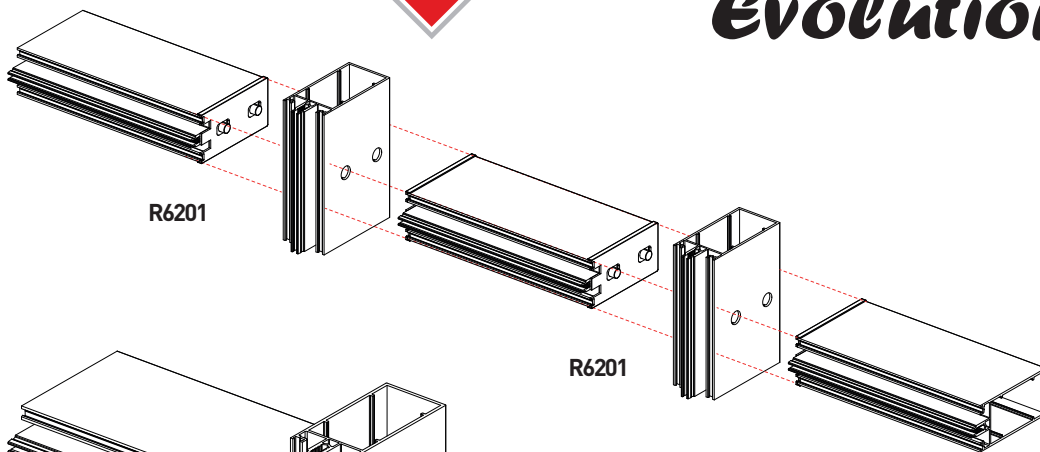
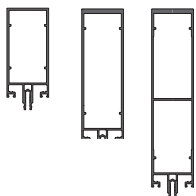

Fase 2

Inserimento Cavallotti
Insertion of Cavallotti
EWA.021

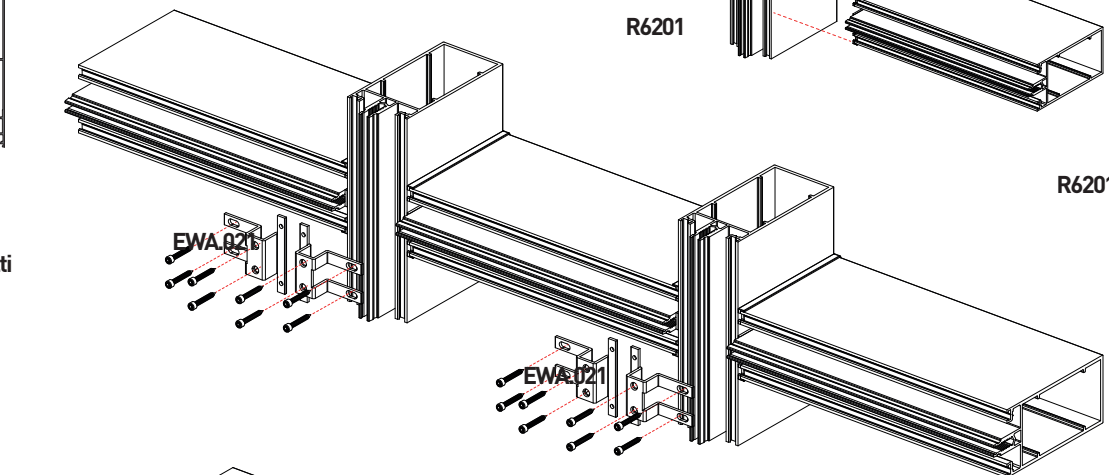
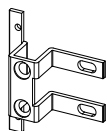

Fase 3

Distanziatore in
POLIAMMIDE
Spacer in POLYAMIDE
BX 34 | EWB03

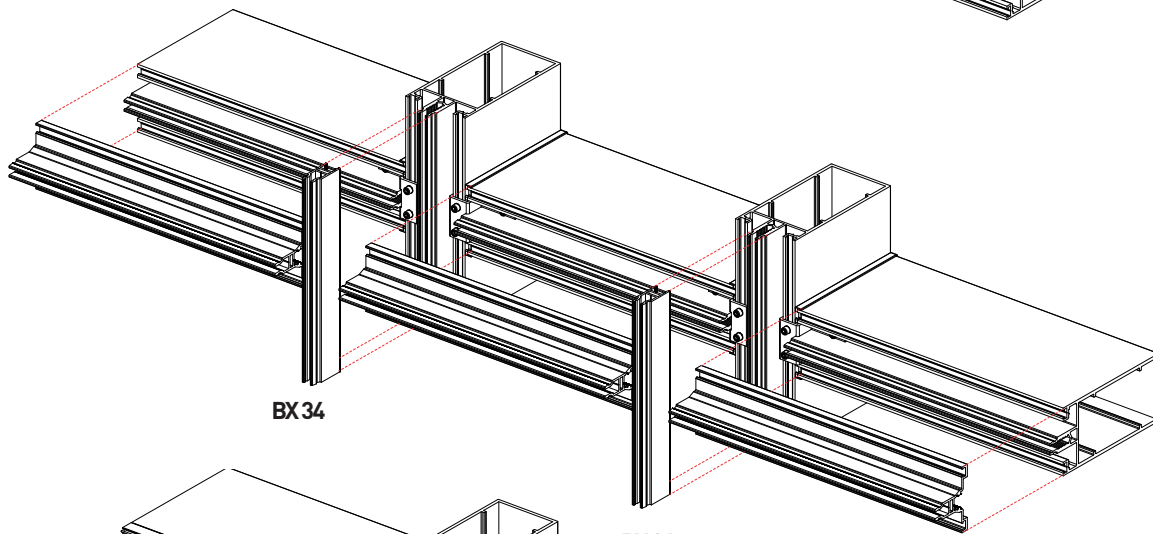
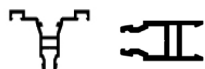

Fase 4

Installazione POGGIAVETRO R6236
R6236 GLASS REST installation

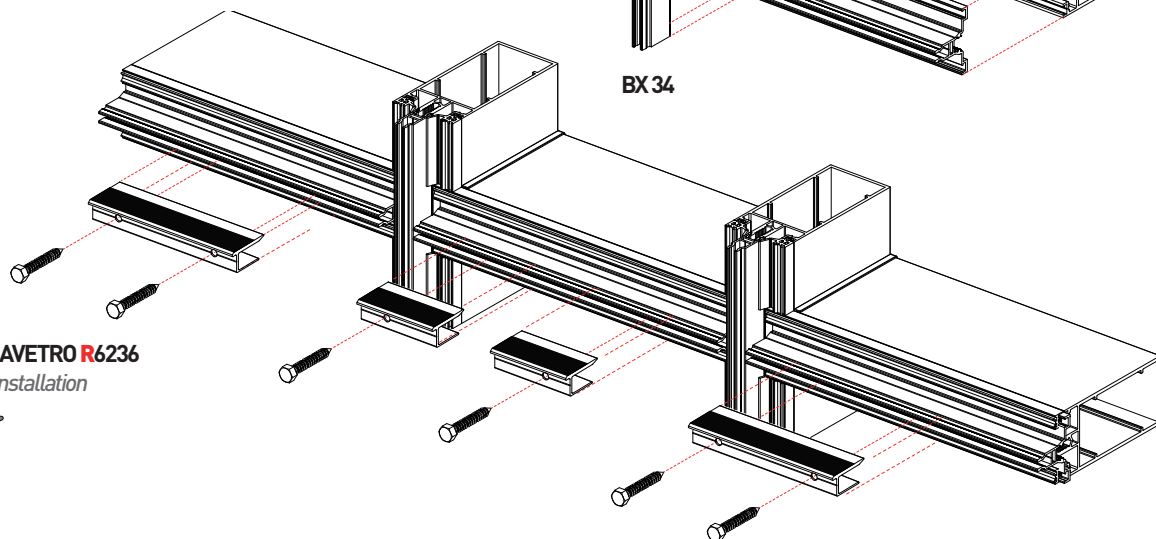



Evolution

Fase 5

Applicazione Distanziatori
EWB01/02/03
Application Spacers
EWB01/02/03



EWB.01 EWB.02 EWB.03

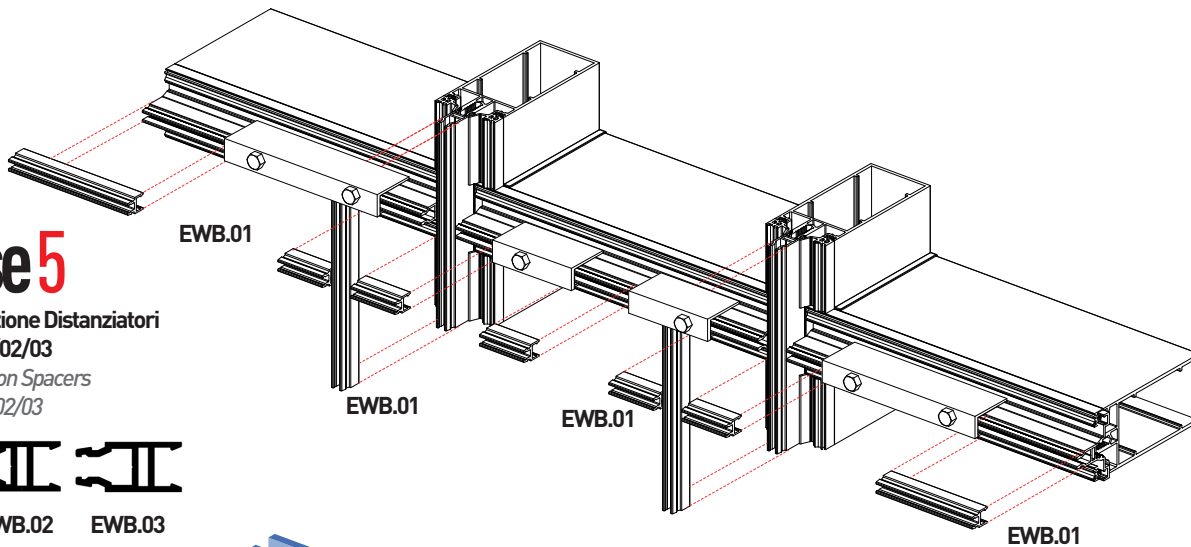

Fase 6

Vetri e Pressori
EWG.01 | R3996
Glazings and Pressers
EWG.01 | R3996



EWG.01



R3996

EWG.01 + R3996

EWG.01 + R3996

EWG.01 + R3996

EWG.01 + R3996

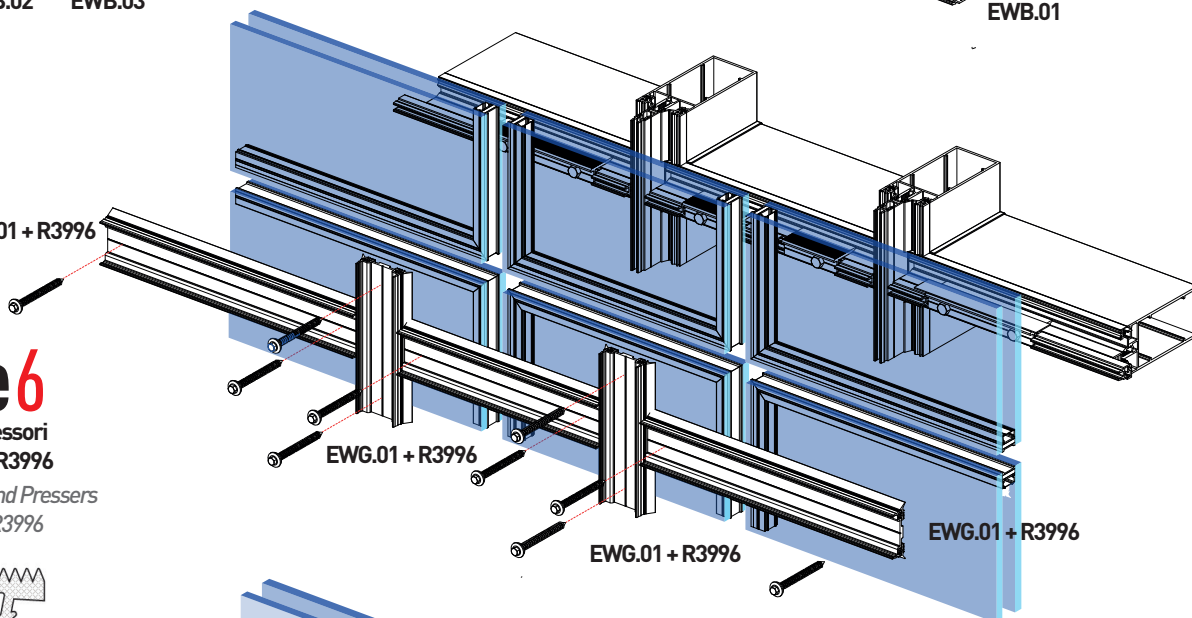

Fase 7

Carter
R5617 | R3994
Carter
R5617 | R3994



R5617 R3994

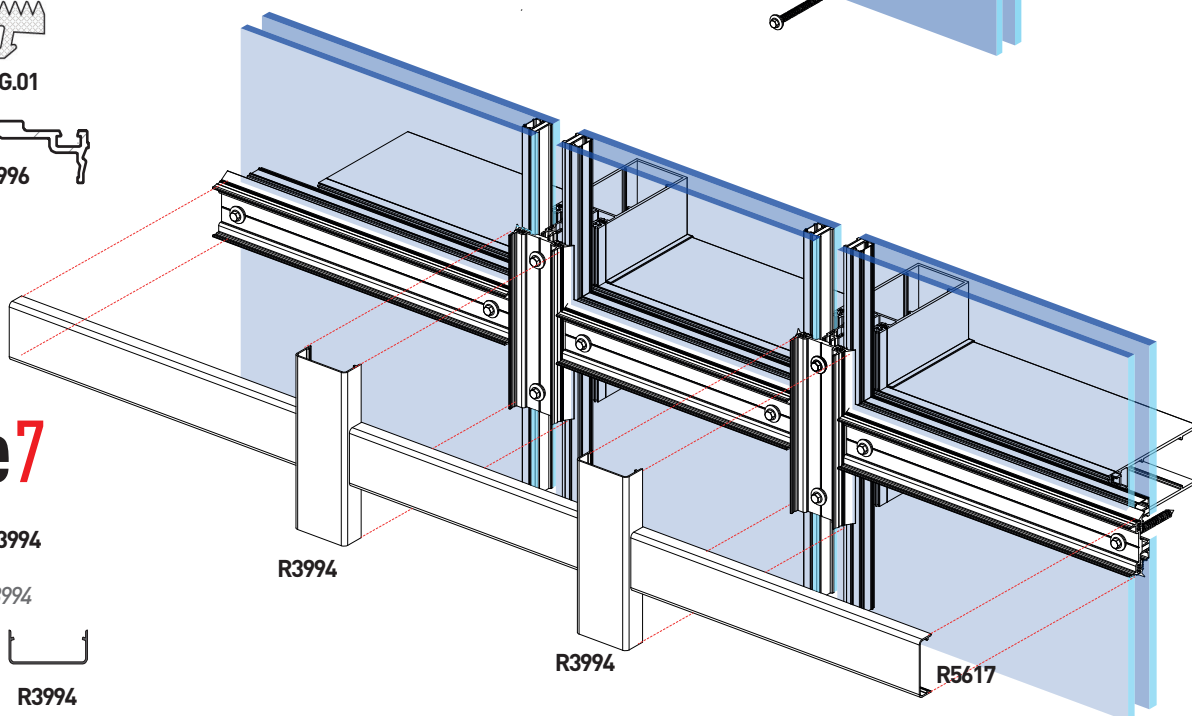



Evolution

LAVORAZIONE EWB.03L

PROCESSING EWB.03L

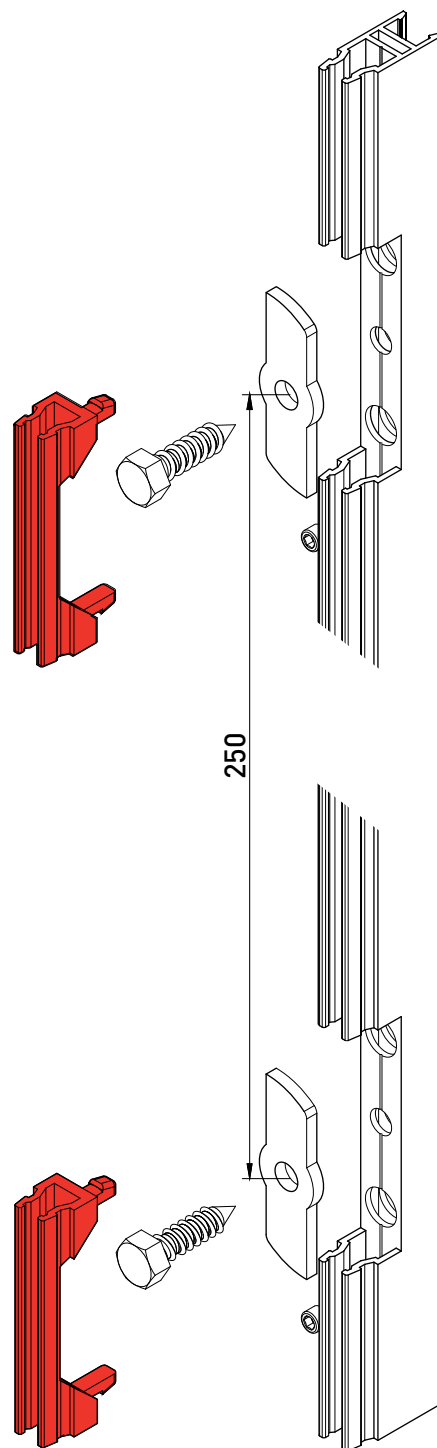
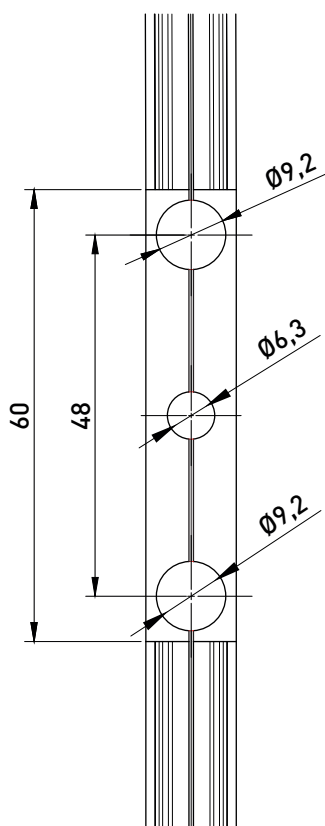
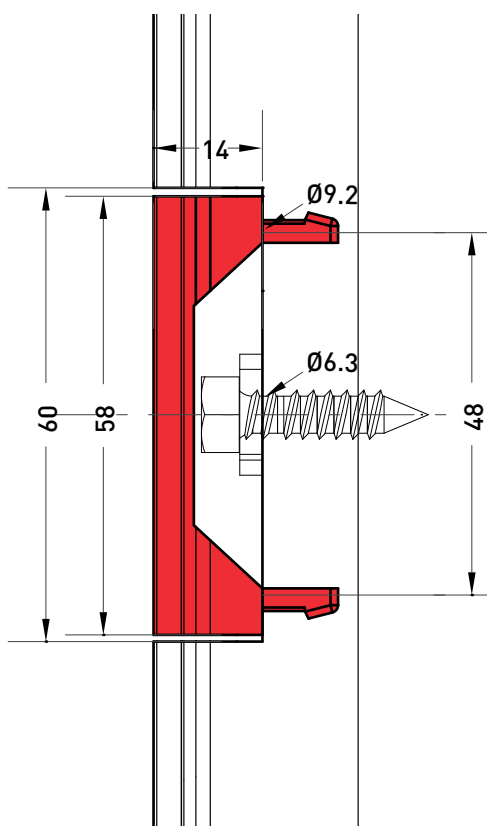



Evolution

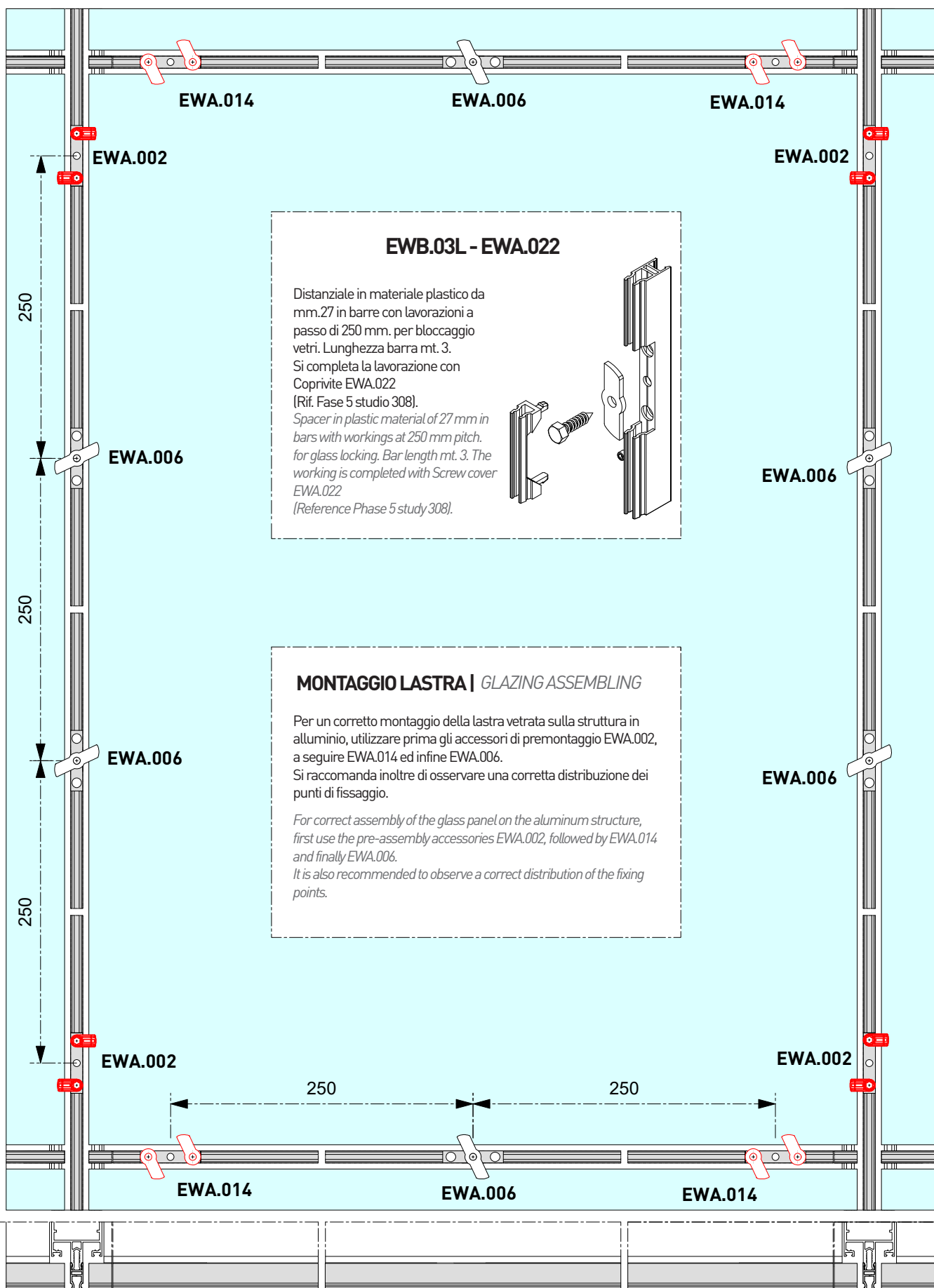



**DISTANZIALE IN MATERIALE PLASTICO CON
LAVORAZIONI PER BLOCCAGGIO VETRI**
*SPACER IN PLASTIC MATERIAL WITH WORKING
FOR GLASS LOCKING*

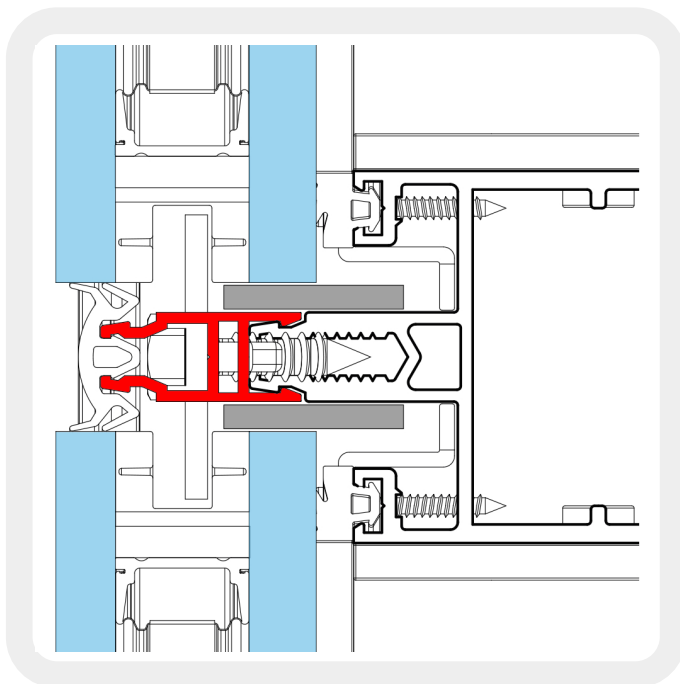

Fase 1

**Inserimento Distanziatori
(Lavorazione ogni 25 cm).
(Vedi Tav. G15)**

*Insertion of Spacers
(Processing every 25 cm).
(G15)*

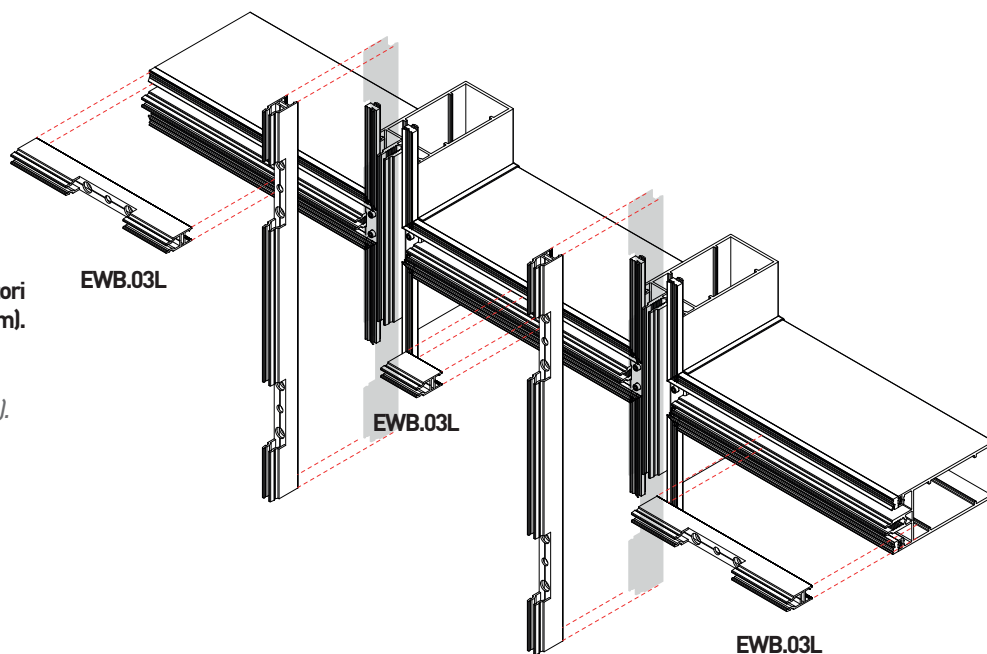



Fase 2

Installazione supporto
vetro EWA.015
Installation Glazing support
EWA.015

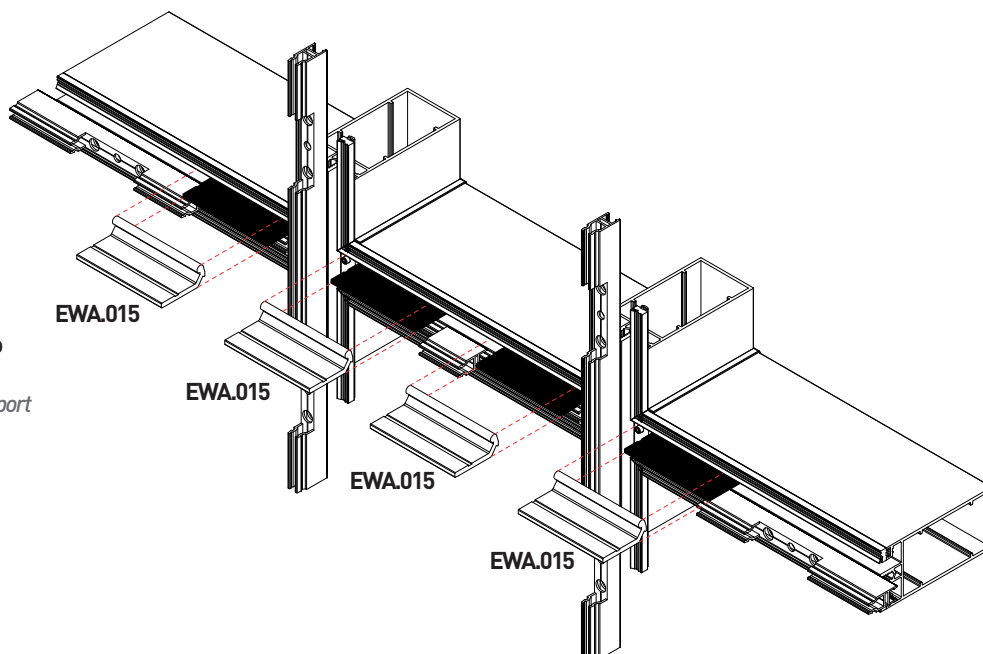
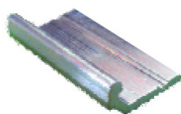

Fase 3

Applicazione Fermavetro
EWA.006
Glazing stopper application
EWA.006

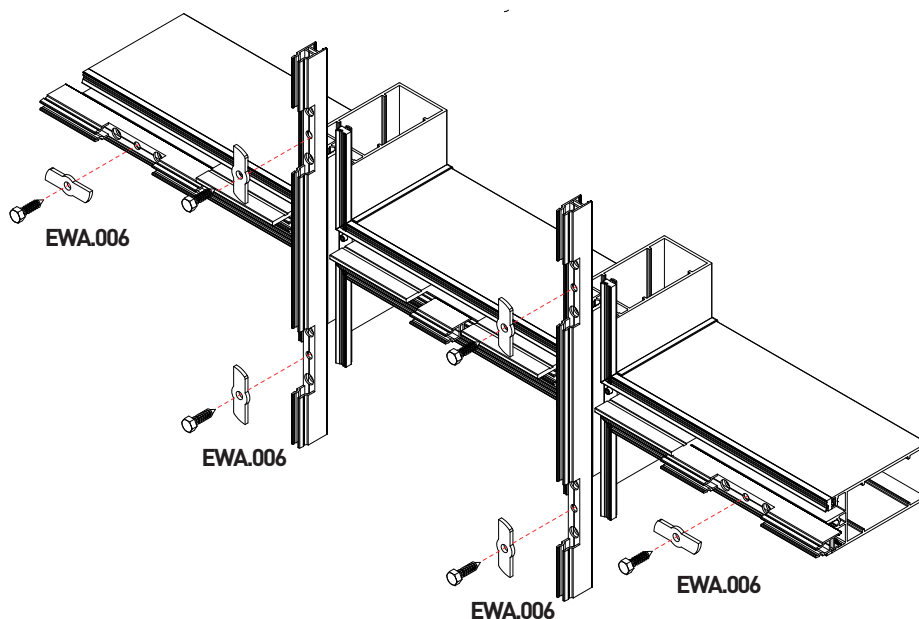



Fase 4

Fissaggio Vetri | Glazings fixing

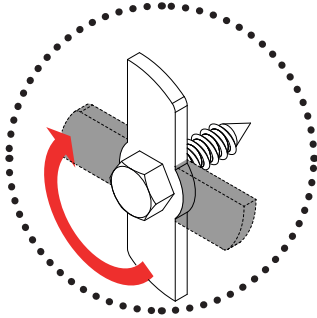

Fase 5

Applicazione Coprivite
EWA.022
(Vedi Tav. G15)

Application Screw cover
EWA.022
(G15)

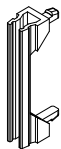

Fase 6

Guarnizione | Gasket
EWG.08

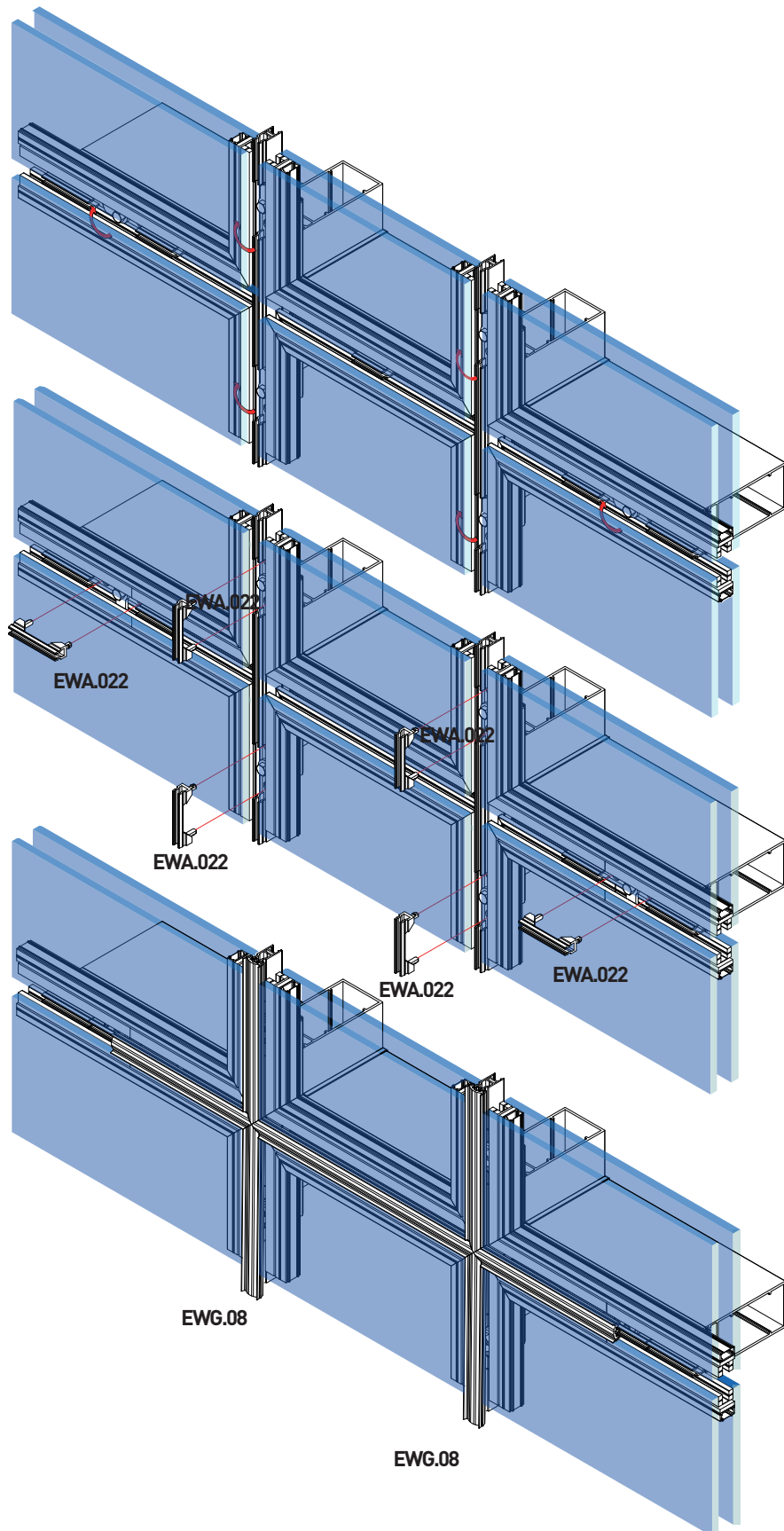
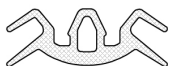



Evolution

INSTALLAZIONE TAPPO EWA023 CARTER ORIZZONTALE R5617 E PRESSORE R3996

INSTALLATION FOR CAP EWA023 ON HORIZONTAL CARTER R5617 AND PRESSOR R3996

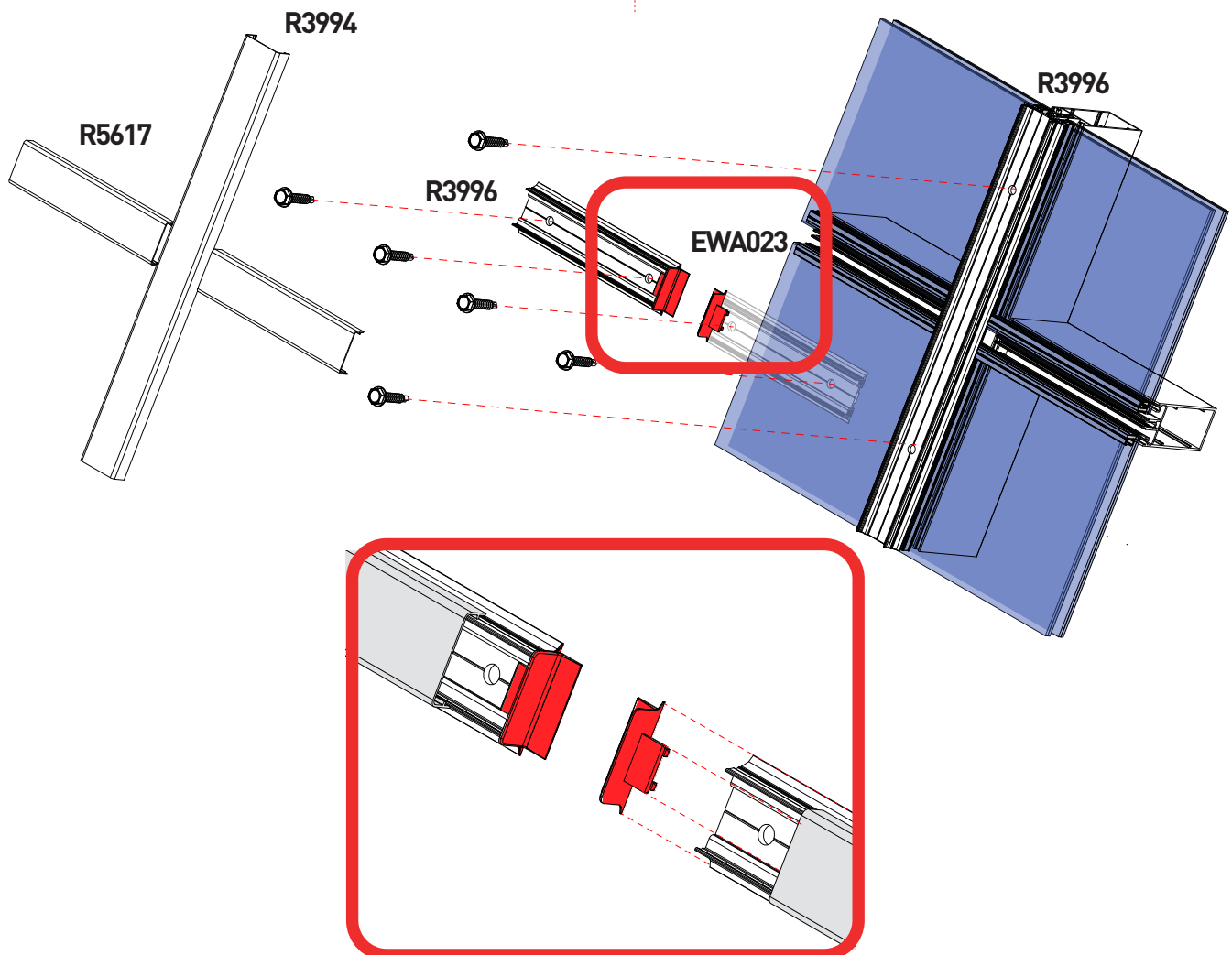
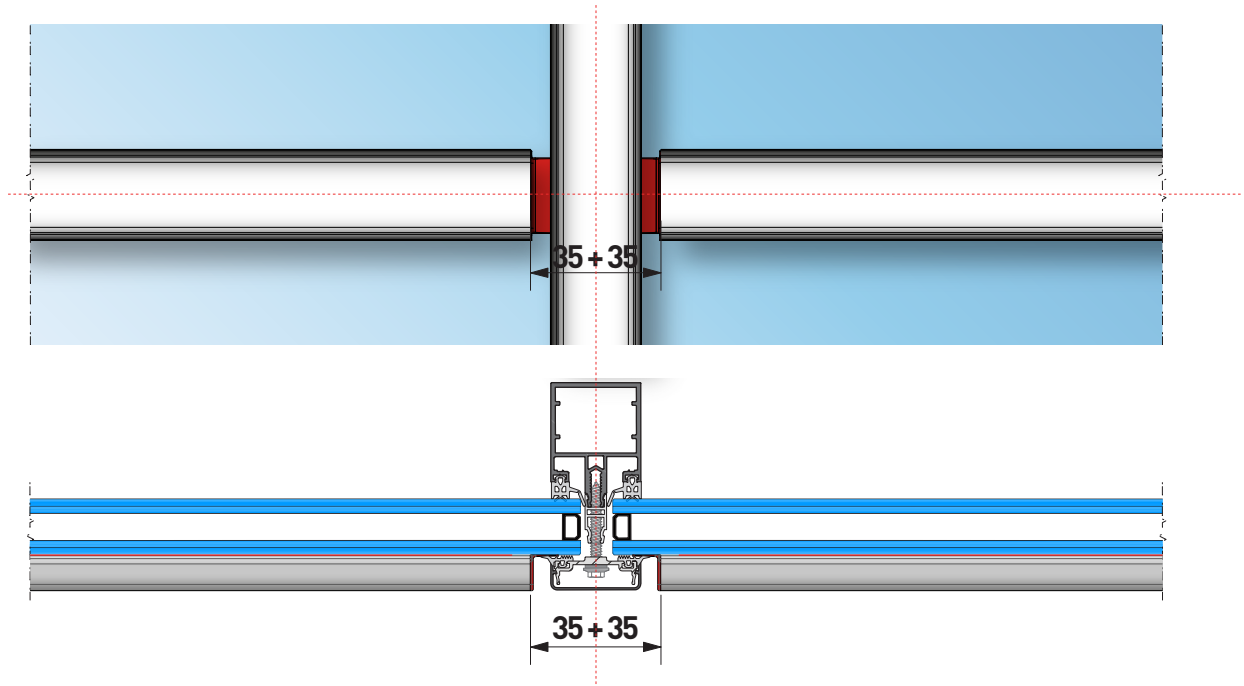



EWA.013 GUARNIZIONE PER APRIBILE
[Carter Orizzontale + GLASS Verticale]

EWA.013 GASKET FOR OPENABLE MODULE
[Horizontal Carter + GLASS on Verticale]

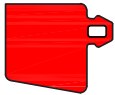

Sezione Orizzontale
Horizontal Section

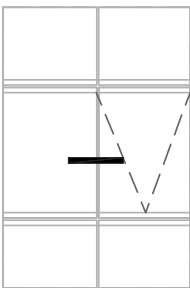

Sezione Verticale
Vertical Section

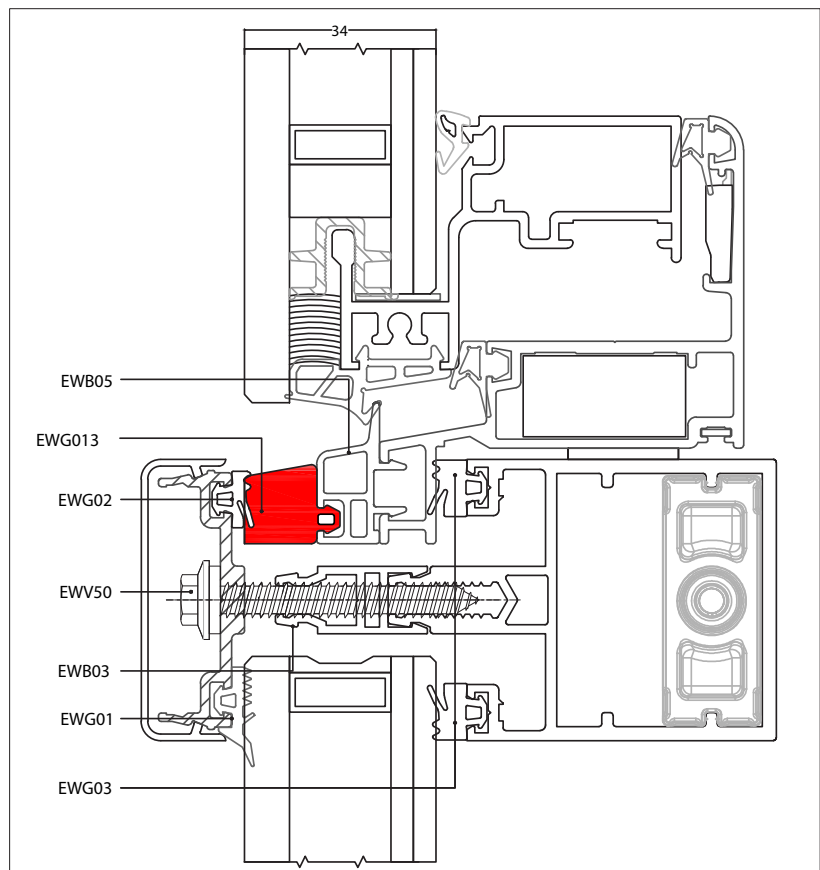
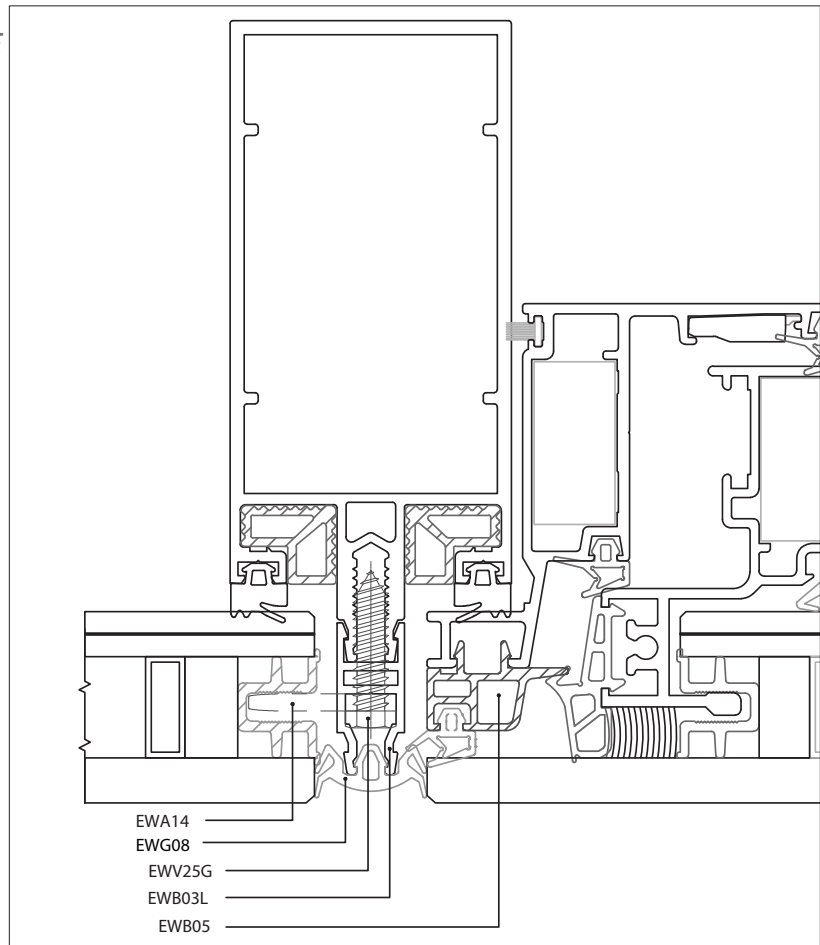
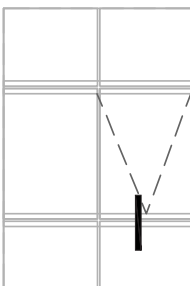

Gli archivi digitali dei prodotti TWIN SYSTEMS
sono disponibili nei formati:

*The digital files of the TWIN SYSTEMS
products are available in the formats at:*



AUTODESK®
AUTOCAD®



AUTODESK®
REVIT®



www.twinsystems.it/web/richiesta-dwg

Il presente Catalogo assieme ai cataloghi di tutti i
prodotti TWIN SYSTEMS sono liberamente scaricabili:

*This Catalog together with the catalogs of all TWIN SYSTEMS
products can be downloaded freely at:*

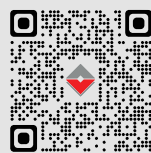

www.twinsystems.it/professionisti/cataloghi/



www.twinsystems.it

PAM SYSTEM S.r.L.

S.S. 230 - Fornace Crocicchio 13030 Formigliana (VC)
Tel. 0161 858811 - Fax 0121 858800
www.pamsystemsrl.com | info@pamsystemsrl.com

ALQ GENOVA s.r.l.

Direzione & Magazzino

Via Colano, 9/A 12/K 16162 Genova Bolzaneto (GE)
Tel. 010 7491941 - Fax 010 7450155

Magazzino

Via Meucci, 25 Calenzano 50041 (FI)
Tel. +39 055 8825060 Fax: +39 055 8824916
www.alqsystem.it | info@alqgenovasrl.com

PAESANI GROUP

Direzione & Magazzino

Via del Grano, 260 47822 Santarcangelo di Romagna (RN)
Tel. 0541 748511

www.paesani.com | info@paesani.com

Magazzino Nord

Via Luigi Bonati, 21 29017 Fiorenzuola d'Arda (PC)
Tel. 0523 943138
magazzinonord@paesani.com

DIVA s.a.s

Via Po, 25 - Z.I. Sambuceto 66020 S.Giovanni Teatino (CH)
Tel. 085 4405210 - Fax 085 4405207

www.camel-diva.com | info@camel-diva.com

EUROALL S.r.l.

Strada Comunale della Mola Saracena, 23 00065 Fiano Romano (RM)

Tel. 0765 455228/61 - Fax 0765 455317

www.euroallslrl.it | info@euroallslrl.it

PROFILATI UMBRIA S.r.l.

Via Dei Tigli, 35 - 06083 Bastia Umbra (PG)

Tel. 075 8012385 | 075 8010328 - Fax 075 8012386

info@profilatiumbria.it

TSL ALLUMINIO S.r.l.

Via delle Industrie, 12 00030 San Cesario (Roma)

Tel. 06 2251591 (Ric. Aut.) - Fax 06 2280693

www.tslalluminio.it | info@tsllalluminio.it

ALLCAR SERVICE S.r.l.

Via Acuto, 120 - 00131 Roma

Tel. 06 4130626 (Ric. Aut.) - Fax 06 4130367

www.allcarservice.it | allcarservice@mclink.it

ALLUCOM S.r.l.

Andria

Via Vecchia Barletta 237 Z. Ind. - 76123 Andria (BT)

Tel. 0883 592213 - Fax 0883 552386

Bari

Via Zippitelli, 28/B - 70123 (BA)

Tel. 0805058608 - Fax 0805058607

www.allucom.com | info@allucom.com

CARUSO S.r.l.

Z.I. Contrada Le Macere 86019 Vinchiatturo (CB)

Tel. 0874 340024 - Fax 0874340025

carusosrl1@libero.it

CAIMAR S.n.c.

Direzione & Magazzino

Strada Prov.le Rimedio-Torregrande Km. 4
09072 Cabras (OR) - Tel. 0783 290118

Filiale

Fronte S.S. 131 Km. 17,450 - 09023 Monastir (CA)

Tel. 070 9166020 - Fax 070 9166191

www.caimar.it | caimarmail@caimar.it

SALENTO METALLI S.r.l.

Via Federico II, 13 - Zona PIP - 73020 Cavallino (LE)

Tel. 0832 614576 - Fax 0832 614635

www.salentometalli.it | info@salentometalli.it

MIDA ALLUMINIO S.r.l.

Napoli

Via Piano del Principe, 36

80047 San Giuseppe Vesuviano (NA)

Tel. 081 5297373 - Fax 081 8284449

Salerno

Loc. Terzerie, Z.I. - 80061 Ogliastro Cilento (SA)

Tel. 0974 833233 - Fax 0974 844724

www.gruppomida.it | info@gruppomida.it

ITALBACOLOR S.r.l.

C.da Valle S. Maria - 87024 Fuscaldo (CS)

Tel. 0982 618025 - Fax 0982 720235

www.italbacolor.it | commerciale@italbacolor.it

COMAS S.r.l.

Via Porta Palermo, 84 - 91011 Alcamo (TP)

Tel. 0924 507050 - Fax 0924 507051

www.comasgroup.it | info@comasgroup.it

ALUK TIM

Aluk Tim D.o.o.

Žegoti 10, 51215 Kastav Croazia, UE

Tel: +385 (0) 51/691 461 - Fax: +385 (0) 51/691 473

Filiale di Zagabria

Franje Lučića, 34A Zagabria Croazia, UE

Tel: +385 (0) 1 6462 611 - Fax: +385 (0) 1 6462 610

Mob: +385 (0) 99 2939656

zagreb@aluk.hr

Filiale Spalato

Street Sv. Nikole Tavelića, 13A 21204

Dugopolje Croazia, UE

Tel: +385 (0) 21225525

Fax: +385 (0) 21660110

Mob: +385 (0) 99 2199228

split@aluk.hr



Consorzio TWIN SYSTEMS

Via delle Macere, 20 | 00060 Formello [Roma]

Tel./Fax 06 23260298

info@twinsystems.it

