

CX600

FINESTRE A BATTENTE
CON TAGLIO TERMICO



TWIN
SYSTEMS

ARCHITETTURE IN ALLUMINIO

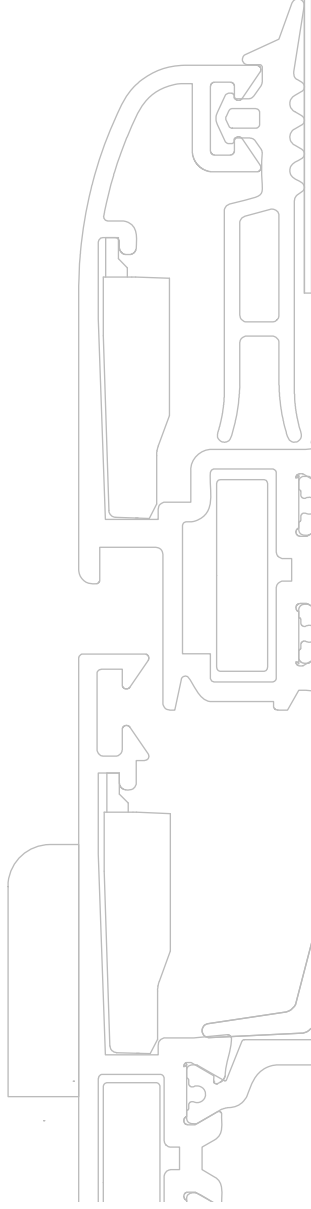

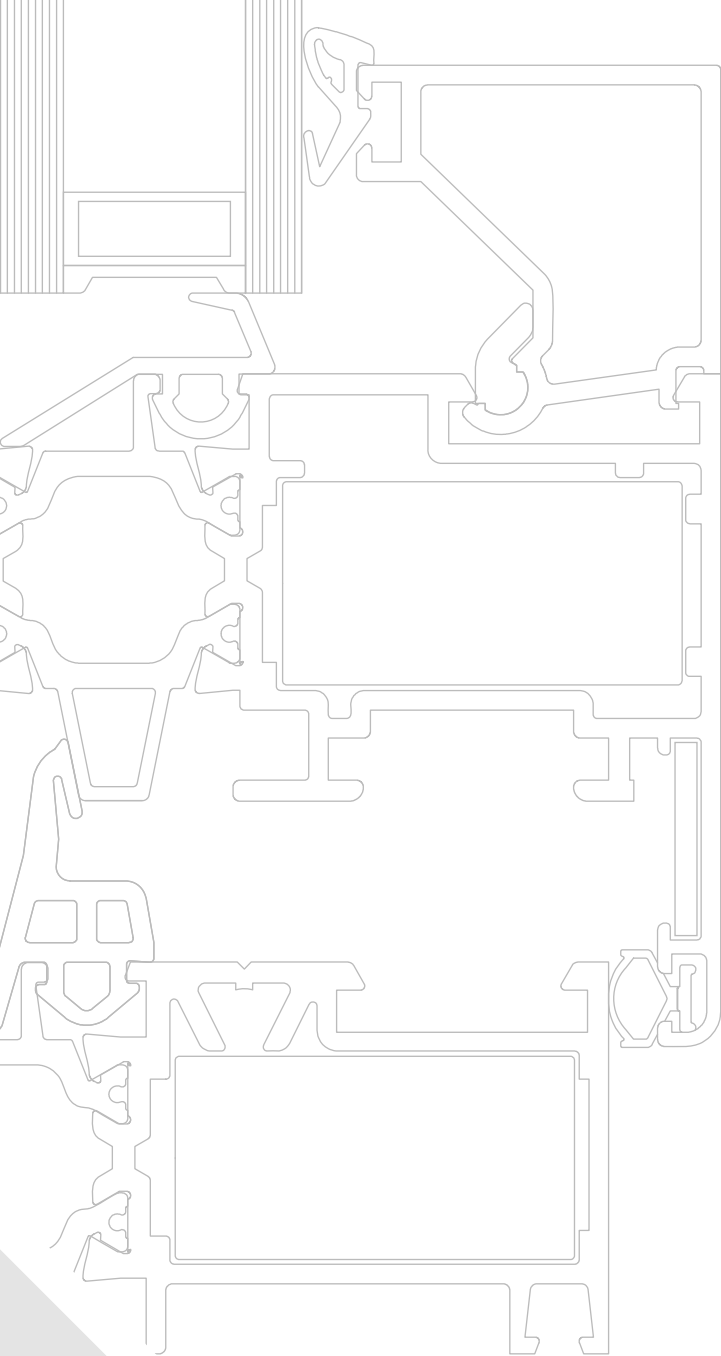

CX600

FINESTRE A BATTENTE
CON TAGLIO TERMICO





| | | |
|--------------------------------|-----------------|-----------------------------------------------------------------------------------------------------------------------------------------|
| Informazioni generali | Gruppo A | Indice generale Caratteristiche alluminio Descrizione tecnica sistema Descrizione tecnica capitolato Collaudi prestazionali |
| Profilati | Gruppo B | Elenco profilati Profilati scala 1.1 |
| Accessori e Guarnizioni | Gruppo C | Elenco accessori Elenco guarnizioni |
| Sezioni | Gruppo D | Sezioni principali in scala 1:1 corredate dei relativi accessori |
| Tipologie | Gruppo E | Principali tipologie di finestre |
| Collegamento muratura | Gruppo F | Sezione particolareggiata attacco alla muratura |
| Lavorazioni / Montaggi | Gruppo G | Schemi lavorazioni Frese Attrezzature |

**PESO PROFILATI**

Il peso indicato è quello teorico e potrà variare in funzione delle tolleranze di spessore e dimensionali dei profilati (NORMA UNI EN 12020-2)

LEGA DI ESTRUSIONE

I profilati sono estrusi in lega EN-AW-6060 (UNI EN 573/3)

DIMENSIONI DEI PROFILATI

Le dimensioni indicate sono quelle teoriche, potranno quindi variare in funzione delle tolleranze dimensionali di estrusione (norma UNI EN 12020-2). Questa variabilità che interessa tutti i profilati, può influire, anche se minimamente, sulle dimensioni di taglio e quindi finali del serramento. Anche la verniciatura, aumentando gli spessori, contribuisce a far variare la dimensione dei profilati e, particolarmente, riduce lo spazio nelle sedi di inserimento delle guarnizioni e degli accessori.

DIMENSIONI DI TAGLIO E LAVORAZIONI

Le dimensioni teoriche di taglio e le quote delle lavorazioni indicate nel presente catalogo sono esatte, ovvero matematicamente corrette, in certi casi dovranno, nella pratica, essere adattate in base alla precisione ed al tipo di impostazione delle misure delle macchine utilizzate. È pertanto consigliabile nei primi lavori o nel caso di importanti quantità di serramenti effettuare delle campionature di prova.

PROTEZIONE SUPERFICIALE

Al fine di limitare i processi di corrosione filiforme è importante applicare le seguenti regole:

- utilizzare accessori di assemblaggio in alluminio utilizzare viti in acciaio inox ,
- proteggere le parti tagliate e lavorate con prodotti idonei
- evitare ristagni di condense all'interno dei profilati.

Per la realizzazione di serramenti è necessario attenersi alla tecnologia costruttiva e utilizzare le guarnizioni e gli accessori originali riportati sul catalogo tecnico e al rispetto delle norme, prescrizioni e raccomandazioni vigenti. L'osservanza di quanto sopra determina la garanzia .Su queste basi sono stati realizzati campioni che, collaudati in laboratorio hanno ottenuto i risultati indicati nelle certificazioni. Per il buon funzionamento e la durata degli infissi realizzati con profilati ed accessori del sistema , è necessario effettuare alcune semplici operazioni: una buona pulizia, eliminando residui di calce, cemento e/o altro. È consigliabile peraltro proteggere il manufatto sino al momento della messa in esercizio, lubrificare con olio o grasso neutri le parti in movimento e gli organi di chiusura, controllare il corretto serraggio delle viti e dei grani, controllare gli assetti, registrandoli laddove sono previste regolazioni. Si raccomanda di effettuare queste operazioni almeno con cadenza semestrale. In caso di funzionamento anomalo di qualche componente, evitare assolutamente interventi atti a modificarne le caratteristiche e la sostituzione con ricambi non originali. Ci sembra utile ricordare che interventi di regolazione e/o sostituzione, con particolare riferimento ai meccanismi per oscillo-battente, andranno eseguiti da personale specializzato. Si raccomanda inoltre, in occasione delle operazioni di pulizia, di non utilizzare detergenti che possano deteriorare i trattamenti superficiali, escludendo tassativamente acidi, solventi, materiali abrasivi, spazzole metalliche o comunque in grado di scalfire le superfici, pagliette metalliche e altro.

DIMENSIONI E TIPOLOGIA DEI SERRAMENTI

La valutazione delle dimensioni dei serramenti, richiede la considerazione di vari fattori quali: il momento d'inerzia dei profilati ,le dimensioni e il peso dei tamponamenti (vetri-pannelli),la larghezza e l'altezza delle parti apribili caratteristiche e portate degli accessori,le condizioni e le quantità degli ancoraggi alle opere morte,l'esposizione, ecc...Fattori che sono valutabili e applicabili, grazie alla buona conoscenza dello stato dell'arte, alle informazioni riportate dai cataloghi, manuali tecnici e dalle normative vigenti. Consigliamo, al fine di evitare inutili contestazioni, di consultare il nostro servizio tecnico sistemi, prima di realizzare serramenti che, per dimensione, forma, esposizione e/o altro possono essere ritenuti atipici. Le soluzioni e le combinazioni proposte in questo catalogo, non hanno carattere limitativo, ma presentano solo le situazioni e combinazioni più comunemente riscontrabili nella realtà. Soluzioni e combinazioni diverse, così come l'adozione di componentistica particolare, ad esempio meccanismi per la realizzazione di ante scorrevoli parallele, ante scorrevoli a libro o altro, sono possibili. A questo proposito il nostro servizio tecnico prodotti per l'edilizia può valutare e proporre le soluzioni più idonee.



DESCRIZIONE TECNICA PER CAPITOLATO

I profilati per serramenti saranno in lega di alluminio ENAW 6060 (EN 573-3 e EN 755-2) con stato fisico di fornitura UNI EN 515. I telai fissi e le ante mobili dovranno essere realizzati con profilati ad interruzione di ponte termico a tre camere (profilo interno ed esterno tubolari, collegati tra di loro con barrette in poliammide PA 6.6 rinforzate con fibra di vetro).

INFISSI

Le finestre e le porte finestre dovranno avere un profilato di telaio fisso con profondità minima 60 mm. ed un profilato di anta mobile con profondità minima 68/70 mm. I profilati di telaio fisso dovranno prevedere, dove necessario, alette incorporate di battuta interna sulla muratura da 22 mm . I profilati di ante mobili dovranno avere un'aletta esterna di battuta per vetro con altezza di 22 mm ed una aletta di battuta interna sul telaio fisso con sormonto di 6 mm. La barretta in poliammide del profilato anta a contatto con la guarnizione di tenuta centrale (giunto aperto), dovrà essere di forma tubolare.

ISOLAMENTO TERMICO

L'interruzione del ponte termico sarà ottenuta da barrette continue in poliammide da 18 mm. totale e dovrà garantire un valore di trasmittanza termica per l'infisso $U_w = \dots\dots\dots$ W/m²K. L'assemblaggio dei profilati in alluminio a taglio termico dovrà garantire i valori di scorrimento (T) tra profilati in alluminio e barrette in poliammide previsti dalla direttiva tecnica Europea (UEAtc).

DRENAGGI E VENTILAZIONE

I profilati esterni delle ante mobili dovranno prevedere una gola ribassata per la raccolta delle acque di infiltrazione e di condensa onde poter permettere il libero deflusso delle stesse attraverso apposite asole di scarico. Le barrette in poliammide dovranno avere una conformazione geometrica atta ad evitare eventuale ristagno di acque di infiltrazione e di condensa ed essere perfettamente complanari con le pareti trasversali dei profilati di alluminio.

ACCESSORI DI ASSEMBLAGGIO

Le giunzioni tra profilati orizzontali e verticali dovranno essere perfettamente solidali e ben allineate tra di loro, sia nella parte esterna che interna dei profilati ed unite mediante apposite squadrette a bottone o, in alternativa, in alluminio estruso o pressofuso, con metodo a spino-cianfrinatura od a cianfrinatura totale. Le sezioni dei profilati orizzontali e verticali dovranno essere opportunamente sigillate prima di essere unite con le squadrette. I fermavetri saranno accoppiati a scatto e posizionati nei canali dei profilati in alluminio .

GUARNIZIONI

Tutte le guarnizioni: cingivetro, di tenuta, di battuta.... dovranno essere in elastomero (EPDM). In particolare la guarnizione di tenuta centrale (giunto aperto) dovrà assicurare la continuità perimetrale mediante l'impiego di angoli vulcanizzati preformati incollati alla stessa o in alternativa mediante telai vulcanizzati.

PRESTAZIONI

I serramenti dovranno avere prestazioni di permeabilità all'aria, tenuta all'acqua e resistenza ai carichi del vento conformemente alle norme :
(UNI-EN 12207 - 12208 - 12210 e UNI-EN 1026 - 1027 - 12211)

Permeabilità all'aria : classe **4**
Tenuta all'acqua : classe **E 1500**
Resistenza al vento : classe **C 5**



CX 600

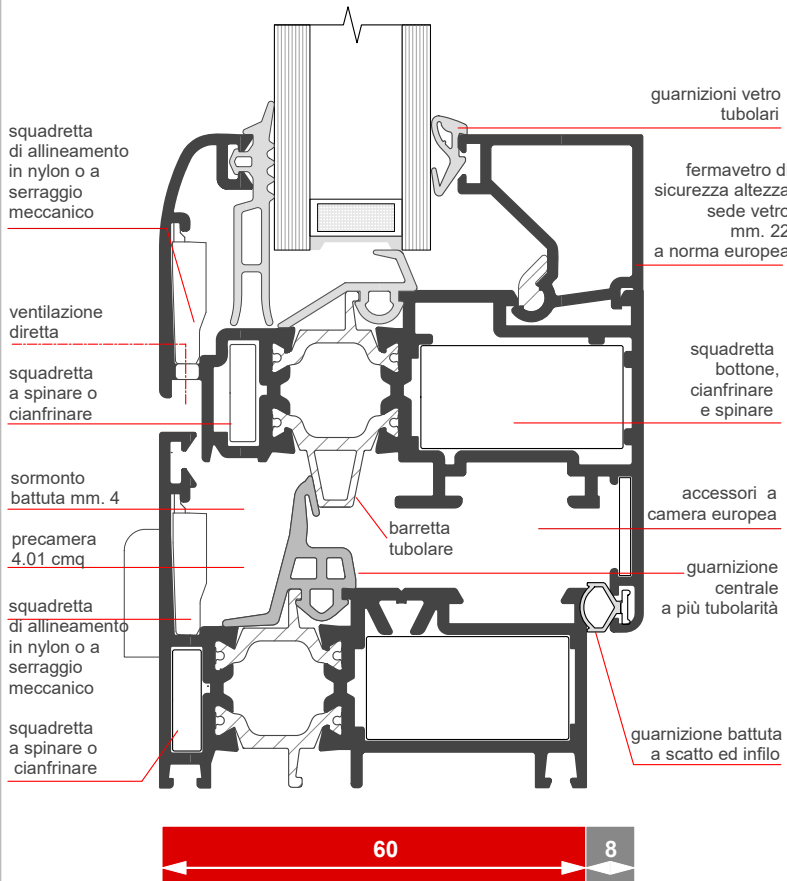

Schema dimensionale:

| | |
|--------------------------|--------------------------------------------------|
| Telaio fisso : | mm. 60 |
| Telaio mobile: | mm. 68/70 (complanare) secondo profilo |
| Barrette isolanti: | mm. 18 sia per telaio che anta |
| Fuga perimetrale : | mm. 5 |
| Alloggiamento accessori: | a Camera Europea spazio 11.5 mm. |
| Giunzione angolare: | con squadrette a bottone, spingere o cianfrinare |



Analisi termica con FLIXO vers.7 e WinIso2D Professional 7.8

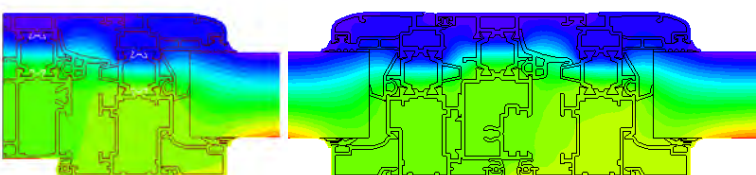

Risultati dei test/ CE product pass conforme ad UNI EN 14351-1:2006+A1:2010

| | |
|--------------------------------|----------------------|
| Permeabilità all'aria: | Classe 4 |
| Tenuta all'acqua: | Classe E 1500 |
| Resistenza al carico di vento: | Classe C5 |
| Isolamento acustico: | fino a 42 dB |
| Resistenza all'effrazione: | Classe RC 2 |

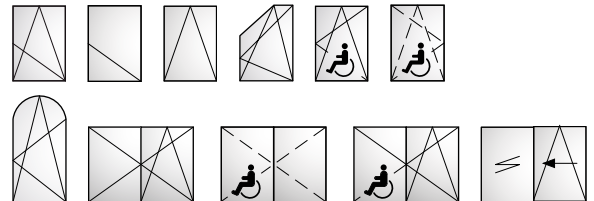

Caratteristiche tecniche:

Tecnologia:

- Sistema a camera multipla ad elevato isolamento termico con design simmetrico e qualità dell'assemblaggio garantita
- Spessore dei tamponamenti fino a 45 mm

Isolamento termico:

Serramento campione

- Valore U_w **1.67** W/(m²K)
con vetro camera $U_g = 1.0$ W/(m²K) certificato con canalina $\psi = 0.036$ W/(m²K) su finestra normalizzata con H = 1480 mm. ed L = 1535 mm.
- Valore U_w **1.31** W/(m²K)
con vetro triplo $U_g = 0.5$ W/(m²K) certificato con canalina $\psi = 0.031$ W/(m²K) su finestra normalizzata con H = 1480 mm. ed L = 1535 mm.

Dimensioni massime ammesse per il calcolo U_w su serramento campione fino a 2.3 mq (secondo norma UNI EN 14351-1:2006+A1:2010)

Ferramenta:

- Sistema con accessori funzionali a camera unificata, spazio 11.5 mm. personalizzati ed a pista 16 mm.
- giunzione angolare con squadrette a bottone/spingere/cianfrinare ed allineamento

Impiego:

- Profilati per finestre che consentono la costruzione di infissi ad una, due o più ante a battente, nella versione a giunto aperto complanari all'esterno e a sormonto all'interno. Sono possibili anche specchiature fisse, wasistas, anta-ribalta. Profilati per porte: consentono la costruzione di porte ad una o due ante, apribili all'interno, con sopraluci fissi od apribili e vetrine



Agenti Atmosferici



Tenuta all'acqua* EN 1027 - EN 12208

Capacità di un inisso di impedire infiltrazioni quando è investito da un'usso d'acqua ed è presente una differenza di pressione tra interno ed esterno.

| | | | | | | | | | | | | | | | |
|-----------------------|-----|------|-------|-------|-------|-------|-------|-------|-------|-------|-------|--------|--------|--------|--------|
| Pressione d'aria Km/h | 0Pa | 50Pa | 100Pa | 150Pa | 200Pa | 250Pa | 300Pa | 450Pa | 600Pa | 750Pa | 900Pa | 1050Pa | 1200Pa | 1350Pa | 1500Pa |
| Classe | - | 1A | 2A | 3A | 4A | 5A | 6A | 7A | 8A | E750 | E900 | E1050 | E1200 | E1350 | E1500 |

L'inisso TWIN, con una pressione del vento pari ad una velocità di 178 Km/h (1500Pa) non ha avuto infiltrazioni

Classe Raggiunta
E 1500

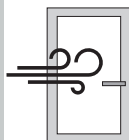

Permeabilità all'aria* EN 1026 - EN 12207

Caratteristica di un inisso chiuso di lasciare filtrare aria quando è presente una differenza di pressione tra l'interno e l'esterno; minori saranno i volumi dispersi, maggiore sarà la qualità del serramento.

| | | | | |
|------------------------|-------|-------|-------|-------|
| Pressione Vento Classe | 150Pa | 300Pa | 450Pa | 600Pa |
| | 1 | 2 | 3 | 4 |

L'inisso TWIN ha superato la prova con una pressione del vento pari ad una velocità di 111 Km/h (600Pa)

Classe Raggiunta
4

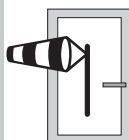

Resistenza al vento* EN 12211 - EN 12210

Capacità di un inisso sottoposto a forti pressioni e/o depressioni, come quelle causate dal vento, di mantenere una deformazione ammissibile, di conservare le proprietà iniziali a salvaguardia della sicurezza degli utenti.

| | | | | | | |
|-----------------------------------|-------------|-------------|-------------|--------|--------|---------|
| Pressione d'aria Flessione Classe | 400Pa | 800Pa | 1200Pa | 1600Pa | 2000Pa | >2000Pa |
| | A (~ 1/150) | B (~ 1/200) | C (~ 1/300) | | | |
| | 1 | 2 | 3 | 4 | 5 | Exxx |

*Serramento a 2 ante, dimensione L = mm.2034 ed H = mm.1834 - Certificato prova n° RP n° 1994-CPD-RP0628 | Disponibili altre certificazioni

Classe Raggiunta
C5

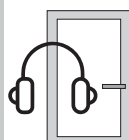

Potere fonoisolante EN ISO 140-3, EN ISO 717-1

Perdita di isolamento acustico rispetto al vetro DRw (dB) a partire dalla classe di permeabilità all'aria dell'inisso (UNI EN 12207)

| | | | | |
|----------------|-----|-----|-----|-----|
| Classe Perdita | 1 | 2 | 3 | 4 |
| | 8dB | 6dB | 4dB | 2dB |

N.B. Per valori DRw < 38 db è ammesso l'utilizzo di questo metodo tabellare

Per valori DRw > 39 db in su è necessario realizzare un campione al vero e sottoporre a prove di Laboratorio.

Attenuazione Rumori Esterni
Fino a
42 dB

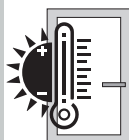

Trasmittanza Termica

Flusso di calore che passa attraverso il serramento per m2 di superficie e per ogni grado di differenza di temperatura tra interno ed esterno.

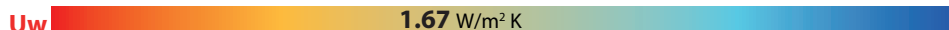

Finestra a 2 ante normalizzata (1535 mm. x 1480 mm; vetro camera Ug=1.0 W/m2K certificato con canalina psi=0.036 W/m K)

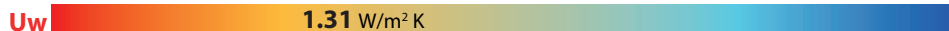

Finestra a 2 ante normalizzata (1535 mm. x 1480 mm; vetro triplo Ug=0.5 W/m2K certificato con canalina psi=0.031 W/m K)

Effrazione



Resistenza all'effrazione

Capacità di un inisso di resistere ad un'intrusione violenta a seguito di una applicazione di una forza fisica e con l'aiuto di attrezzi
Finestra a 2 ante (1230 mm. x 1480 mm) - CERTIFICATO CP384-VAL-3400A.52

| | | | |
|----------------------|---------------------------------------|-------------------------------------------|---------------------|
| Classe di resistenza | RC 1 | RC 2 | RC 3 |
| | forza fisica (calci, pungi, spallate) | semplice attrezzatura (cunei, cacciaviti) | R2 + Piede di Porco |

L'inisso TWIN, resiste in modo efficace ai tentativi di intrusione interna.

Resistenza Effrazione
RC 2

Resistenze Meccaniche

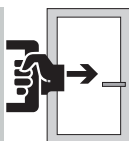

Forze di azionamento EN 13115

Idoneità di un inisso di permettere una facile apertura con uno sforzo minimo

| | | | |
|------------------------|---|---|---|
| Classe Forza Applicata | 0 | 1 | 2 |
|------------------------|---|---|---|

L'inisso TWIN, consente grande facilità di apertura con uno sforzo minimo.

Classe Raggiunta
1

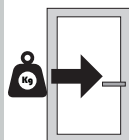

Resistenza meccanica EN 12046 - EN 13115

Capacità di un inisso di resistere ai carichi applicati senza rotture, deformazioni permanenti o torsioni tali da pregiudicare il suo corretto funzionamento.

| | | | | |
|------------------------------------------|-------|-------|-------|-------|
| Classe Carico Verticale Torsione Statica | 1 | 2 | 3 | 4 |
| | 200 N | 400 N | 600 N | 800 N |

L'inisso TWIN resiste ai carichi applicati senza torsioni, deformazioni permanenti o rotture.

Classe Raggiunta
4

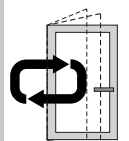

Resistenza ai cicli di apertura e chiusura EN13126 - 4

Capacità di un inisso di resistere nel tempo a ripetuti cicli di apertura e chiusura.

| | | | |
|----------------|--------|--------|--------|
| Grado N° Cicli | 3 | 4 | 5 |
| | 10'000 | 15'000 | 25'000 |

L'inisso TWIN, resiste efficacemente ai cicli di apertura e chiusura

Grado Resistenza
5

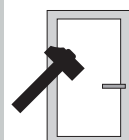

Resistenza all'urto (METODO DI PROVA CON CORPO DURO) EN 13049

Capacità di un inisso di resistere in caso di urti involontari o accidentali.

| | | | | | |
|-----------------------|-------|-------|-------|-------|-------|
| Classe Altezza Caduta | 1 | 2 | 3 | 4 | 5 |
| | 200mm | 300mm | 450mm | 700mm | 950mm |

L'inisso TWIN, resiste efficacemente agli urti.

Classe Raggiunta
1

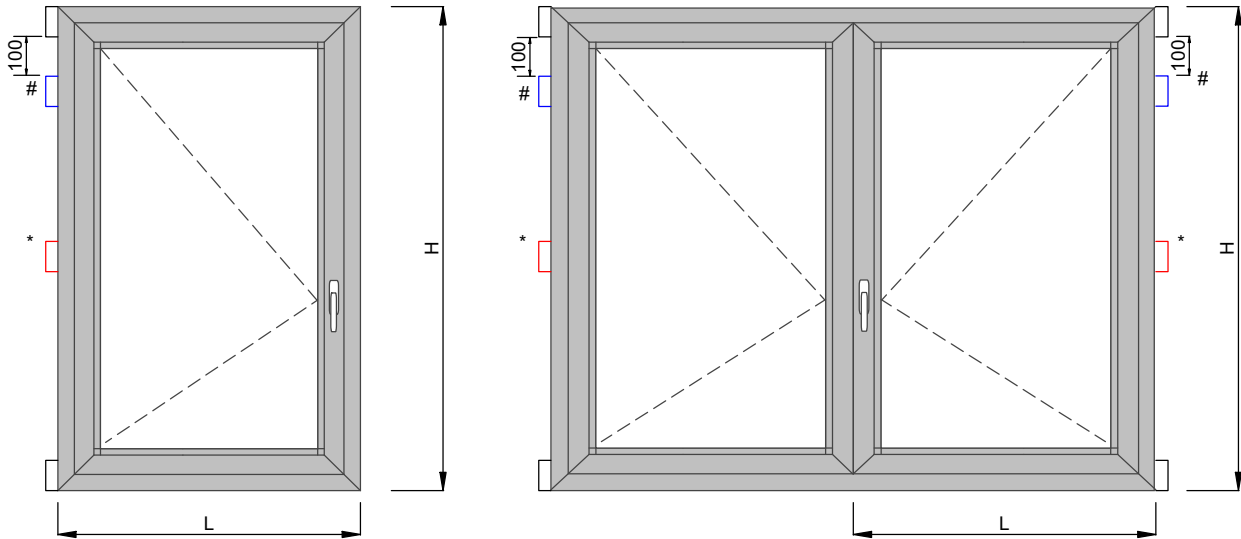
**Battente Una e Due Ante Cerniere
 ACX.02.01 e ACX.02.03**

Dimensioni Anta Minima (LxH): 430 x 500
Norma per Stringa di Prodotto EN 1935:2004

| Tipo | Categoria D'uso (1) | Durabilità (2) | Massa (3) | Resistenza Fuoco (4) | Sicurezza D'uso (5) | Resistenza Corrosione (6) | Resistenza Effrazione (7) | Grado Cerniera (8) |
|------------------|---------------------|----------------|-----------|----------------------|---------------------|---------------------------|---------------------------|--------------------|
| ACX.02.01 | 1 | 4 | 2 (80Kg) | 0 | 1 | 4 | 0 | 6 |
| ACX.02.03 | 1 | 4 | 3 (120Kg) | 0 | 1 | 4 | 0 | 9 |

Dimensione Massime Anta (LxH)

| Un Anta 2 Cerniere | Un Anta 3 Cerniere * | Un Anta 4 Cerniere *e# |
|---------------------|-----------------------|-------------------------|
| 1000x1600 | 1200x1800 | 1300x2100 |
| Due Ante 2 Cerniere | Due Ante 3 Cerniere * | Due Ante 4 Cerniere *e# |
| 1000x1500 | 1000x1700 | 1000x2100 |

Legenda Stringa di Prodotto

| Categoria D'uso (1) | Durabilità (2) Cicli test | Massa (3) x cerniera | Resistenza Fuoco (4) | Sicurezza D'uso (5) | Resistenza Corrosione (6) | Resistenza Effrazione (7) | Grado Cerniera (8) |
|---------------------|---------------------------|----------------------|----------------------|---------------------|-----------------------------------------------------------|---------------------------|----------------------------------------------------------|
| 1:leggero | 3:10.000 | 2: 40 Kg | 0: non idoneo | 1: soddisfatto | 4: 240h in nebbia salina in accordo alla UNI EN 1670:2008 | 1 | il suo valore è dato dalla combinazione di Massa e cicli |
| 2:Medio | 4.25.000 | 3: 60 Kg | | | | | |
| 3:Pesante | 7:200.000 | 4: 80 Kg | | | | | |
| 4:Intenso | | 5: 100 Kg | | | | | |

Battente Una e Due Ante Cerniere a pettine
ACX.08.09

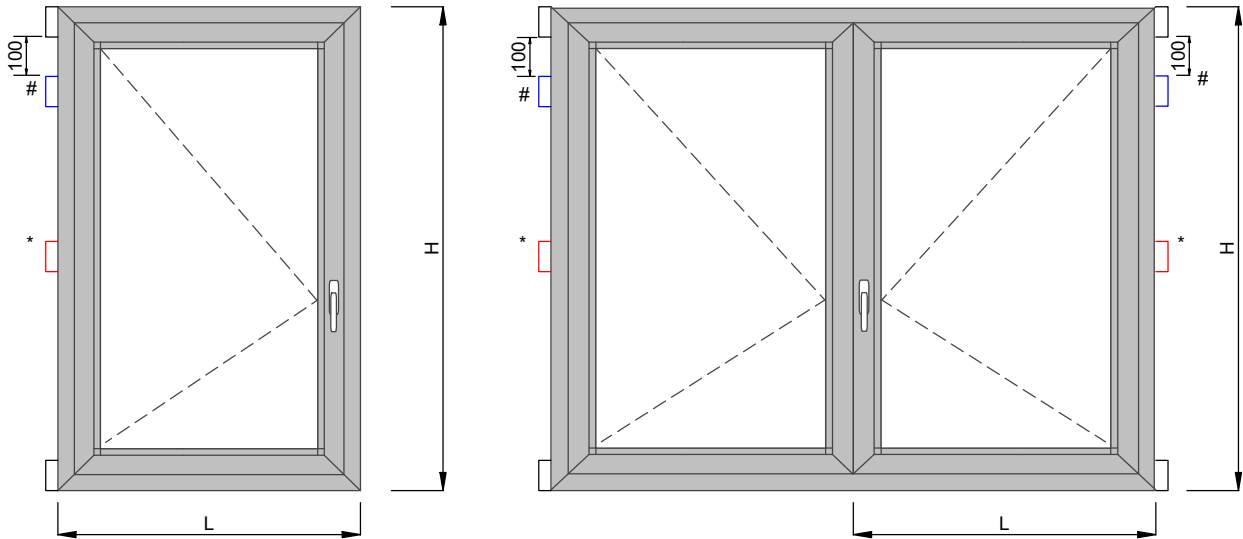

Dimensione Anta Minima (LxH): 430 x 500

| Norma per Stringa di Prodotto EN 1935:2004 | | | | | | | | |
|--------------------------------------------|---------------------------|----------------------|-----------------------|----------------------|-----------------------------------------------------------|---------------------------|----------------------------------------------------------|--------------------|
| Tipo | Categoria D'uso (1) | Durabilità (2) | Massa (3) | Resistenza Fuoco (4) | Sicurezza D'uso (5) | Resistenza Corrosione (6) | Resistenza Effrazione (7) | Grado Cerniera (8) |
| ACX.08.09 | 2 | 7 | 2 (80Kg) | 0 | 1 | 4 | 0 | 7 |
| Dimensione Massime Anta (LxH) | | | | | | | | |
| Un Anta 2 Cerniere | | | Un Anta 3 Cerniere * | | | Un Anta 4 Cerniere *e# | | |
| 1000x1600 | | | 1200x1800 | | | 1300x2100 | | |
| Due Ante 2 Cerniere | | | Due Ante 3 Cerniere * | | | Due Ante 4 Cerniere *e# | | |
| 1000x1500 | | | 1000x1700 | | | 1000x2100 | | |
| Legenda Stringa di Prodotto | | | | | | | | |
| Categoria D'uso (1) | Durabilità (2) Cicli test | Massa (3) x cerniera | Resistenza Fuoco (4) | Sicurezza D'uso (5) | Resistenza Corrosione (6) | Resistenza Effrazione (7) | Grado Cerniera (8) | |
| 1:leggero | 3:10.000 | 2: 40 Kg | 0: non idoneo | 1: soddisfatto | 4: 240h in nebbia salina in accordo alla UNI EN 1670:2008 | 1 | il suo valore è dato dalla combinazione di Massa e cicli | |
| 2:Medio | 4.25.000 | 3: 60 Kg | | | | | | |
| 3:Pesante | 7:200.000 | 4: 80 Kg | 1: idoneo | | | | | |
| 4:Intenso | | 5: 100 Kg | | | | | | |

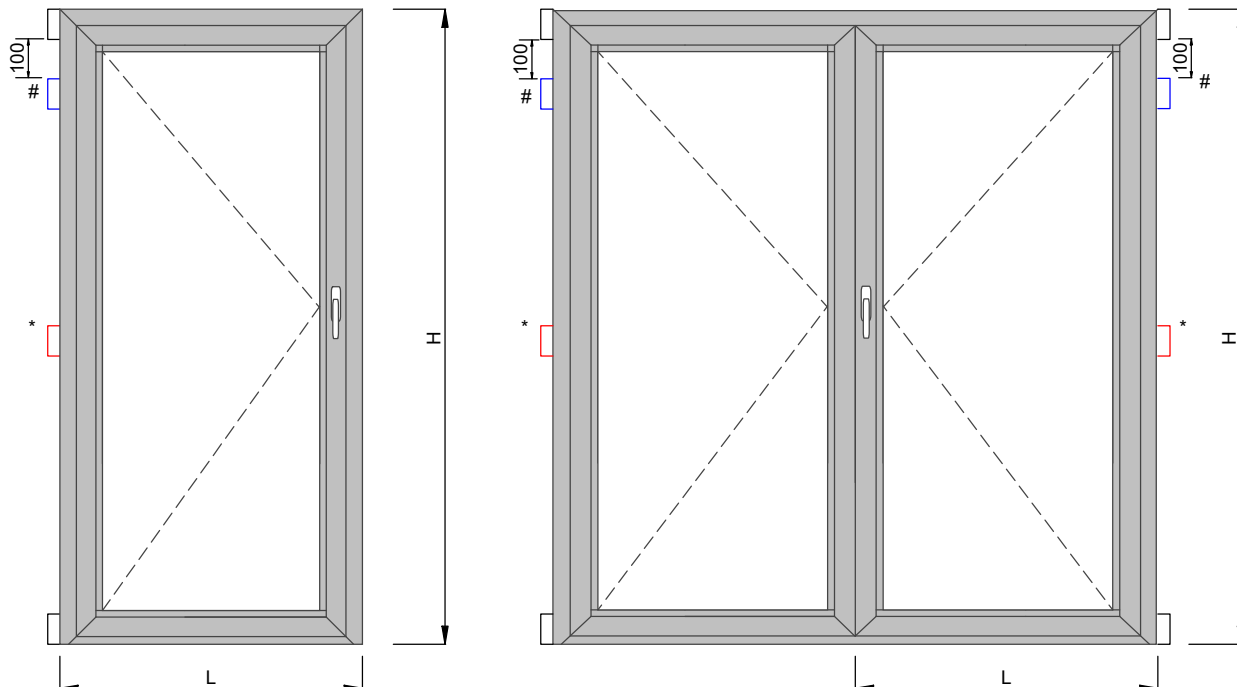
Cerniere per Profili Porte Applicazione Esterna
ARX.02.12 (2 ali) e ARX.02.13 (3 ali)

Norma per Stringa di Prodotto EN 1935:2004

| Tipo | Categoria D'uso (1) | Durabilità (2) | Massa (3) | Resistenza Fuoco (4) | Sicurezza D'uso (5) | Resistenza Corrosione (6) | Resistenza Effrazione (7) | Grado Cerniera (8) |
|------------------|---------------------|----------------|-----------|----------------------|---------------------|---------------------------|---------------------------|--------------------|
| ARX.02.12 | 3 | 7 | 4 (160Kg) | 0 | 1 | 4 | 0 | 11 |
| ARX.02.13 | 3 | 7 | 5 (200Kg) | 0 | 1 | 4 | 0 | 12 |

Dimensione Massime Anta (LxH)

| Un Anta 2 Cerniere | Un Anta 3 Cerniere * | Un Anta 4 Cerniere *e# |
|---------------------|-----------------------|-------------------------|
| 1000x2200 | 1200x2200 | 1300x2200 |
| Due Ante 2 Cerniere | Due Ante 3 Cerniere * | Due Ante 4 Cerniere *e# |
| 800x2200 | 1000x2200 | - |

Legenda Stringa di Prodotto

| Categoria D'uso (1) | Durabilità (2) Cicli test | Massa (3) x cerniera | Resistenza Fuoco (4) | Sicurezza D'uso (5) | Resistenza Corrosione (6) | Resistenza Effrazione (7) | Grado Cerniera (8) |
|---------------------|---------------------------|----------------------|----------------------|---------------------|-----------------------------------------------------------|---------------------------|----------------------------------------------------------|
| 1:leggero | 3:10.000 | 2: 40 Kg | 0: non idoneo | 1: soddisfatto | 4: 240h in nebbia salina in accordo alla UNI EN 1670:2008 | 1 | il suo valore è dato dalla combinazione di Massa e cicli |
| 2:Medio | 4.25.000 | 3: 60 Kg | | | | | |
| 3:Pesante | 7:200.000 | 4: 80 Kg | 1: idoneo | | | | |
| 4:Intenso | | 5: 100 Kg | | | | | |

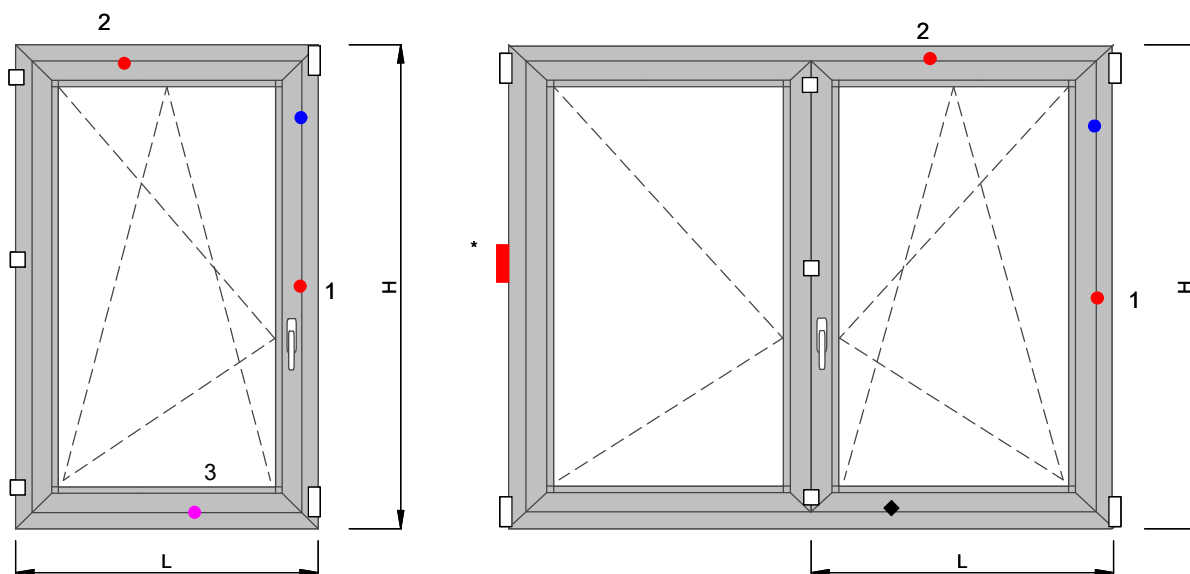
Aperture Oscillo battenti (140 Kg.) Una e Due Ante
ACX.08.01 e ACX.08.01 L

- Punti di chiusura su Kit base **ARX.08.01**
- ◆ + □ Punti di chiusura su Kit base **ARX.08.01 L**
- Punti di chiusura supplementari **ARX.08.06**
- Punti di chiusura supplementari **ARX.08.16**
- Punti di chiusura supplementari **ARX.08.16**

Norma per Stringa di Prodotto UNI EN 13126-8:2006

| Tipo | Categoria D'uso (1) | Durabilità (2) | Massa (3) | Resistenza Fuoco (4) | Sicurezza D'uso (5) | Resistenza Corrosione (6) | Resistenza Effrazione (7) | Applicazione (8) | Dimensione di prova (9) |
|-------------------|---------------------|----------------|-----------|----------------------|---------------------|---------------------------|---------------------------|------------------|-------------------------|
| ACX.08.01 | - | 4 | (140Kg) | 0 | 1 | 4 | - | 8 | 1550x1400 |
| ACX.08.01L | - | 4 | (140Kg) | 0 | 1 | 4 | - | 8 | 1550x1400 |

Braccio corto ACX.08.22 e ACX.08.22L

| | Anta Singola LxH | Anta Doppia LxH | Punti di chiusura |
|----------------|------------------|-----------------|------------------------|
| Dimensioni Min | 395x500 | 395x500 | ACX.08.01 - ACX.08.01L |
| Dimensioni Max | 450x500 | 450x500 | ARX.08.01 - ARX.08.01L |

Braccio Medio ACX.08.03 e ACX.08.22L

| | Anta Singola LxH | Anta Doppia LxH | Punti di chiusura |
|----------------|------------------|-----------------|----------------------------|
| Dimensioni Min | 451x500 | 445x500 | ACX.08.01 - ACX.08.01L |
| Dimensioni Max | 650x1200 | 650x1200 | KIT + ACX.08.06 |
| Dimensioni Max | 650x2200 | 650x2200 | KIT+ ACX.08.06 + ACX.08.16 |

Braccio Lungo ACX.08.24 e ACX.08.24L

| | Anta Singola LxH | Anta Doppia LxH | Punti di chiusura |
|----------------|------------------|-----------------|-----------------------------------|
| Dimensioni Min | 651x600 | 651x600 | ACX.08.01 - ACX.08.01L |
| Dimensioni Max | 651x1400 | 651x1400 | ACX.08.01 + ACX.08.06 |
| Dimensioni Max | 651x2200 | 651x2200 | KIT + ACX.08.06 + ACX.08.16 |
| Dimensioni Max | 1200x1400 | 1200x1400 | KIT+ ACX.08.06 + ACX.08.16 (n°2) |
| Dimensioni Max | 1200x2200 | 1200x2200 | KIT + ACX.08.06 + ACX.08.16 (n°3) |
| Dimensioni Max | 1200x1400 | - | KIT + ACX.08.06 + ACX.08.16 (n°3) |
| Dimensioni Max | 1200x2200 | - | - |

Legenda Stringa di Prodotto

| Categoria D'uso (1) | Durabilità (2) Cicli | Massa (3) | Resistenza Fuoco (4) | Sicurezza D'uso (5) | Resistenza Corrosione (6) | Resistenza Effrazione (7) | Applicazione (8) | Dimensione di prova (9) |
|---------------------|-----------------------------------|---------------------------|----------------------|---------------------|--------------------------------|---------------------------|------------------|------------------------------------|
| - | 4:15.000 a/r+5.000 battente | Portata Certificazione | 0: non idoneo | 1: Soddisfatto | 4: 240h UNI EN 1670:2008 | - | 8:Privato | Dimensione Campione di prova |

LIMITI IMPIEGO DEL SISTEMA

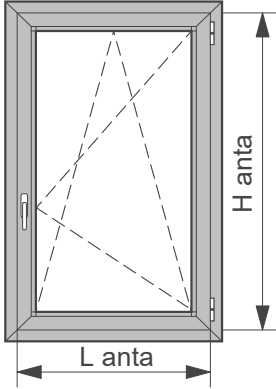
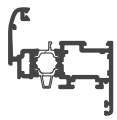
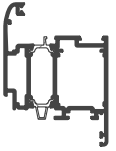
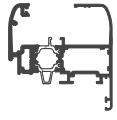
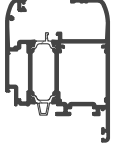
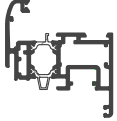
| TIPOLOGIA | | PROFILI | | | | | | |
|-----------------------------------------------------------------------------------|-----------------------------------------------|----------------------------------------------------------------|-------------------|------------------------------------------------------------------------------------|-----------------------------------------------------------------|--------------------|-------------------------------------------------------------------------------------|--|
|  | | CX60.201 | |  | CX60.202 | |  | |
| | | Jx 26.79 cm ⁴ Wx 7.85 cm ³ | | | Jx 36.73 cm ⁴ Wx 10.49 cm ³ | | | |
| | | Jy 9.96 cm ⁴ Wy 2.80 cm ³ | | Jy 31.00 cm ⁴ Wy 6.51 cm ³ | | | | |
| | | CX60.203 | |  | CX60.206 | |  | |
| | | Jx 30.51 cm ⁴ Wx 8.36 cm ³ | | | Jx 40.47 cm ⁴ Wx 11.52 cm ³ | | | |
| | | Jy 14.47 cm ⁴ Wy 3.76 cm ³ | | Jy 39.59 cm ⁴ Wy 7.83 cm ³ | | | | |
| | | CX60.204 | |  | | | | |
| | | Jx 34.02 cm ⁴ Wx 9.43 cm ³ | | | | | | |
| | | Jy 14.03 cm ⁴ Wy 3.71 cm ³ | | | | | | |
| | Pressione del vento (Pa) : 1200 Pascal | | Dimensione Minima | Dimensione Massima | Dimensione Minima | Dimensione Massima | | |
| | Finestra ad 1 anta | L anta (mm) | 430 | 1100 | 430 | 1400 | | |
| | | H anta (mm) | 700 | 1500 | 750 | 1800 | | |
| Porta balcone ad 1 anta | L anta (mm) | 430 | 1000 | 430 | 1200 | | | |
| | H anta (mm) | 750 | 1800 | 750 | 2200 | | | |

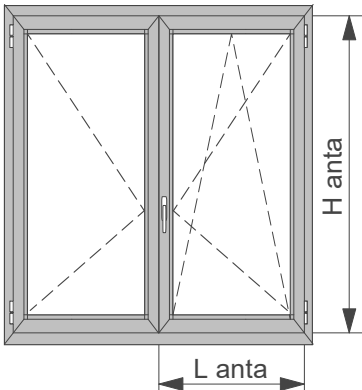
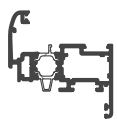
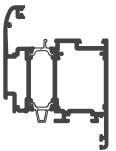
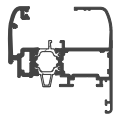
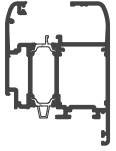
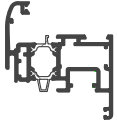
| TIPOLOGIA | | PROFILI | | | | | | |
|-------------------------------------------------------------------------------------|-----------------------------------------------|----------------------------------------------------------------|-------------------|--------------------------------------------------------------------------------------|-----------------------------------------------------------------|--------------------|---------------------------------------------------------------------------------------|--|
|  | | CX60.201 | |  | CX60.202 | |  | |
| | | Jx 26.79 cm ⁴ Wx 7.85 cm ³ | | | Jx 36.73 cm ⁴ Wx 10.49 cm ³ | | | |
| | | Jy 9.96 cm ⁴ Wy 2.80 cm ³ | | Jy 31.00 cm ⁴ Wy 6.51 cm ³ | | | | |
| | | CX60.203 | |  | CX60.206 | |  | |
| | | Jx 30.51 cm ⁴ Wx 8.36 cm ³ | | | Jx 40.47 cm ⁴ Wx 11.52 cm ³ | | | |
| | | Jy 14.47 cm ⁴ Wy 3.76 cm ³ | | Jy 39.59 cm ⁴ Wy 7.83 cm ³ | | | | |
| | | CX60.204 | |  | | | | |
| | | Jx 34.02 cm ⁴ Wx 9.43 cm ³ | | | | | | |
| | | Jy 14.03 cm ⁴ Wy 3.71 cm ³ | | | | | | |
| | Pressione del vento (Pa) : 1200 Pascal | | Dimensione Minima | Dimensione Massima | Dimensione Minima | Dimensione Massima | | |
| | Finestra ad 2 anta | L anta (mm) | 430 | 850 | 430 | 1000 | | |
| | | H anta (mm) | 700 | 1450 | 750 | 1600 | | |
| Porta balcone ad 2 anta | L anta (mm) | 430 | 850 | 430 | 1000 | | | |
| | H anta (mm) | 750 | 1800 | 750 | 2200 | | | |



LA MARCATURA CE DELLE FINESTRE E PORTE PEDONALI SENZA CARATTERISTICHE DI RESISTENZA AL FUOCO E/O DI TENUTA AL FUMO

Il marchio **CE**, apposto sui prodotti da costruzione, attesta la loro conformità ai requisiti essenziali definiti dalla direttiva 89/106/CE "Prodotti da costruzione", emanata dal Consiglio della Comunità Europea il 21/12/1988 ed attuata, in Italia, dal D.P.R. n. 246 del 21/04/1993.

La marcatura CE di uno specifico prodotto da costruzione diviene obbligatoria, al fine di immettere il prodotto in un mercato della Comunità Europea, allorché sia stata emessa dal CEN, su mandato della Comunità Europea, una "specificazione tecnica" (norma o benessere tecnico) che regolamenti la sua applicazione.

La responsabilità per la verifica dei requisiti del prodotto e per l'apposizione della marcatura CE spetta al suo fabbricante.

Al fine di garantire i requisiti richiesti dalle relative norme, il fabbricante è tenuto a:

- predisporre un piano di controllo della produzione (FPC). E' un sistema di procedure e controlli da eseguire durante le fasi di produzione;

- effettuare delle "prove iniziali di tipo" (ITT) sul prodotto al fine di determinare le prestazioni. Le modalità di prova dei requisiti del prodotto sono definite dalle norme richiamate dalla specifica norma prodotto".

Alcune prove possono essere eseguite dal produttore stesso, secondo le disposizioni delle relative norme armonizzate, mentre altri requisiti sono di competenza di laboratori in possesso di una notifica attribuita loro dallo stato membro di appartenenza (organismi notificati).

Il fabbricante può procedere in più modi:

eseguire autonomamente i test sui propri prodotti presso un istituto Notificato, diventando quindi titolare degli ITT

far riferimento ai risultati di prove effettuate dal detentore del sistema di serramento, purché quest'ultimo abbia espresso il proprio consenso per mezzo di un contratto di licenza d'uso stipulato tra le parti.

Dal mese di Febbraio 2010 è obbligatoria la marcatura CE per finestre e porte pedonabili senza caratteristiche di resistenza al fuoco e tenuta al fumo.

L'appendice ZA della norma UNI EN 14351-1 specifica le caratteristiche essenziali per finestre e porte e attribuisce le competenze delle prove iniziali di tipo.

Per finestre e porte senza funzione di compartimentazione del fuoco o fumo e non poste nelle vie di fuga (sistema di attestazione della conformità 3):

| Caratteristiche essenziali | Espressioni delle prestazioni | Competenza Prove Iniziali Tipo | | |
|--------------------------------------------------------|-------------------------------|---------------------------------------------|-----------|-----------|
| | | ON = Organismo Notificato ; PR = Produttore | | |
| | | Finestre | Porte | Lucernari |
| Comportamento al fuoco dall'esterno | | | | ON |
| Reazione al fuoco | Euroclassi | | | ON |
| Tenuta all'acqua | Classi tecniche | ON | ON | ON |
| Sostanze pericolose | | ON | ON | |
| Resistenza al carico del vento | Classi tecniche | ON | ON | PR |
| Resistenza al carico della neve e al carico permanente | KN/mq | | | PR |
| Resistenza all'urto | Classi tecniche | | PR | ON |
| Capacità portante dei dispositivi di sicurezza | Soglia | ON | ON | ON |
| Altezza | mm. | | PR | |
| Forze di azionamento (solo dispositivi automatici) | Classi tecniche | | ON | |
| Prestazione acustica | dB | ON | ON | ON |
| Trasmittanza termica | W/mqK | ON | ON | ON |
| Proprietà radioattive | | | | PR |
| Permeabilità all'aria | Classi tecniche | ON | ON | ON |



Il requisito relativo ad una determinata caratteristica non è applicabile in quegli Stati Membri nei quali non sussistono requisiti di regolamentazione per tale caratteristica per l'impiego previsto del prodotto. In questo caso, i fabbricanti che immettono i loro prodotti sul mercato di questi Stati membri non sono obbligati a determinare né a dichiarare le prestazioni dei loro prodotti in relazione a questa caratteristica e può essere utilizzata l'opzione "Nessuna Prestazione Determinata" (NPD) nelle informazioni che accompagnano la marcatura CE (vedere punto ZA.3). Tuttavia, l'opzione NPD non può essere utilizzata nel caso in cui la caratteristica sia soggetta a un livello soglia.

(Citazione integrale tratta dalla norma UNI EN 14351-1 - appendice ZA)

Pertanto, la valutazione delle caratteristiche da dichiarare è funzione della destinazione d'uso del prodotto e della legislazione vigente nello Stato Membro, ove esso è immesso.

TEST INIZIALI DI TIPO EFFETTUATI SULLE FINESTRE

La serie riportata nel presente catalogo è stata sottoposta a test iniziali di tipo (ITT) relativamente ai requisiti previsti dalla norma prodotto UNI EN 14351-1

I risultati dei test iniziali di tipo sono estendibili a serramenti di differente tipologia e con differenti dimensioni e componenti, secondo le indicazioni fornite dalla norma EN 14351-1 in Appendice A (interdipendenza fra le caratteristiche e i componenti), Appendice E (determinazione delle caratteristiche) ed Appendice F (selezione facoltativa di provini rappresentativi per le finestre)

Il costruttore di serramenti ha la responsabilità di verificare la rispondenza del serramento prodotto rispetto al campione sottoposto a prova.

Il consorzio TWIN Systems mette a disposizione dei propri clienti i risultati dei test effettuati, a seguito della stipulazione di un contratto d'uso gratuito degli stessi.

Dichiarazione di Conformità

Il fabbricante del serramento è tenuto a consegnare al committente una dichiarazione di conformità la quale, in accordo alla norma UNI EN 14351-1, deve includere :

Nome ed indirizzo del fabbricante o del suo rappresentante autorizzato con sede nella EEA;

Descrizione del prodotto (tipo, identificazione, impiego, ecc.) e una copia delle informazioni che accompagnano la marcatura CE;

Disposizioni alle quali il prodotto è conforme (appendice AZ della norma prodotto UNI EN 14351-1);

Condizioni particolari applicabili all'impiego del prodotto (per esempio disposizioni per l'impiego in determinate condizioni, ecc.);

Nome e indirizzo del/i laboratorio/i approvato/i.

Nome e qualifica della persona incaricata di firmare la dichiarazione per conto del fabbricante o del suo rappresentante autorizzato.

La dichiarazione e il certificato devono essere presentati nella lingua o nelle lingue ufficiali dello Stato Membro in cui il prodotto deve essere utilizzato.

Etichettatura e Marcatura

Il fabbricante deve fornire informazioni sufficienti ad assicurare la rintracciabilità del suo prodotto fornendo il collegamento fra il prodotto, il fabbricante e la produzione. Queste informazioni devono essere contenute su un'etichetta o specificate in documenti di accompagnamento nelle specifiche tecniche pubblicate dal fabbricante.

Le informazioni seguenti devono accompagnare il simbolo di marcatura CE:

Nome e indirizzo registrato o marchio di identificazione del fabbricante;

Ultime due cifre dell'anno in cui la marcatura CE è stata applicata;

Riferimento alla norma di prodotto (EN 14351-1);

Descrizione del prodotto: nome generico, materiale, dimensioni, ecc. e impiego previsto;

Informazioni sulle caratteristiche essenziali che devono essere dichiarate presentate come:

Valori dichiarati o livelli e/o classi;

NPD -" Nessuna prestazione determinata" per le caratteristiche quando è pertinente.

Il simbolo della marcatura CE e le informazioni di accompagnamento devono essere apposti in modo visibile, leggibile e indelebile in una o più delle posizioni seguenti (gerarchia di preferenza del fabbricante):

Qualsiasi parte idonea del prodotto stesso, purché sia assicurata la visibilità quando si aprono le ante;

Su un'etichetta attaccata;

Sul suo imballaggio;

Sul documento commerciale di accompagnamento.



Documentazione Tecnica di Accompagnamento

Il fabbricante deve fornire informazioni su quanto segue:

Immagazzinaggio e movimentazione, se il fabbricante non è responsabile dell'installazione del prodotto;

Requisiti e tecniche d'installazione (sul posto), se il fabbricante non è responsabile dell'installazione del prodotto (Guida UNCSAAL);

Manutenzione e pulizia (Manuale Consorzio TWIN SYSTEMS)

Istruzioni d'uso finali incluse le istruzioni per la sostituzione di componenti;

Istruzioni per l'uso in condizioni di sicurezza.

In Italia i requisiti obbligatori per la Marcatura CE sono:

Permeabilità dell'aria;

Trasmittanza termica;

Proprietà radiative (Fattore solare g, Trasmissione luminosa (TV)).

In Spagna e in Portogallo i requisiti obbligatori per la Marcatura CE sono :

Permeabilità all'aria;

Tenuta all'acqua;

Resistenza al vento;

Trasmittanza termica;

Isolamento acustico.

TRASMITTANZA TERMICA DEI SERRAMENTI

E' necessario sapere che le prescrizioni dettate dal decreto ministeriale cambiano in funzione della tipologia di intervento edilizio (nuova costruzione, ristrutturazione importante di primo oppure secondo livello, riqualificazione energetica) e si applicano ad edifici sia pubblici sia privati.

Per edifici di **nuova costruzione** si intendono quei fabbricati il cui titolo abilitativo sia stato richiesto dopo l'entrata in vigore del decreto.

Sono **assimilati agli edifici di nuova costruzione** gli edifici sottoposti a **demolizione e ricostruzione**, qualunque sia il titolo abilitativo necessario, e gli ampliamenti di edifici esistenti la cui nuova porzione abbia un volume lordo climatizzato superiore al 15% di quello esistente o comunque superiore a 500 m³.

Per **interventi di ristrutturazione importante di primo livello** si intendono quelli che interessano l'involucro edilizio con un'incidenza superiore al 50 per cento della superficie disperdente lorda complessiva dell'edificio, comprendendo anche la ristrutturazione dell'impianto termico per il servizio di climatizzazione invernale e/o estiva asservito all'intero edificio.

Per **interventi di ristrutturazione importante di secondo livello** si intendono quelli che interessano l'involucro edilizio con un'incidenza superiore al 25 per cento della superficie disperdente lorda complessiva dell'edificio e possono interessare l'impianto termico per il servizio di climatizzazione invernale e/o estiva.

Negli **interventi di riqualificazione energetica** rientrano gli interventi non riconducibili agli interventi succitati e che hanno un impatto sulla prestazione energetica dell'edificio. Rientrano quindi anche:

- le ristrutturazioni che interessano l'involucro edilizio con un'incidenza inferiore o uguale al 25 per cento della superficie disperdente lorda complessiva dell'edificio e/o consistono nella nuova installazione, nella ristrutturazione di un impianto termico asservito all'edificio o di altri interventi parziali, ivi compresa la sostituzione del generatore;
- gli ampliamenti di edifici esistenti la cui nuova porzione abbia un volume lordo climatizzato inferiore o uguale al 15% di quello esistente o comunque inferiore a 500 m³.

Per gli edifici di nuova costruzione e per quelli sottoposti a ristrutturazioni di primo livello, non sono previsti specifici limiti di trasmittanza termica da rispettare per le chiusure trasparenti. Sussiste l'obbligo di rispettare limiti per quanto concerne altri parametri tecnici che connotano gli impianti, l'involucro edilizio e l'edificio nel loro complesso (per esempio coefficiente medio globale di scambio termico per trasmissione per unità di superficie disperdente HT' - area solare equivalente estiva per unità di superficie utile Asol,est/Asup utile - indice di prestazione termica utile per riscaldamento EPH,nd - indice di prestazione termica utile per il raffrescamento EPC,nd - indice di prestazione energetica globale dell'edificio EPgl,tot, ecc.) contenuti nell'Allegato A del decreto.



I limiti dell'Allegato A sul coefficiente medio globale di scambio termico per trasmissione per unità di superficie disperdente HT' sono da rispettare anche per gli interventi di ristrutturazione importante di secondo livello.

Nell'ambito degli **interventi di ristrutturazione importante di secondo livello e degli interventi di riqualificazione energetica** sono invece da rispettare i limiti riportati nell'**Appendice B** del decreto relativamente:

- **alla trasmittanza termica U_w dei serramenti** (trasparenti, opachi) e **dei cassonetti** posti a delimitazione di ambienti climatizzati verso l'esterno oppure verso ambienti non climatizzati (cfr. **tabella 1**);
- **al fattore di trasmissione solare totale g_{gl+sh} dei serramenti vetriati in combinazione con schermature solari mobili** posizionati sui fronti dell'edificio SUD, EST, OVEST, SUD-EST, SUD-OVEST (cfr. **tabella 2**).

Tabella/Table 1

Valori limite della trasmittanza U_w dei serramenti (trasparenti, opachi) e dei cassonetti posti a delimitazione di ambienti climatizzati verso l'esterno oppure verso ambienti non climatizzati.

| ZONA CLIMATICA | U_w [W/m ² K] | |
|----------------|----------------------------|----------|
| | 2021 | ECOBONUS |
| Zona A | 3.00 | 2.60 |
| Zona B | 3.00 | 2.60 |
| Zona C | 2.00 | 1.75 |
| Zona D | 1.80 | 1.67 |
| Zona E | 1.40 | 1.30 |
| Zona F | 1.00 | 1.00 |

Tabella/Table 2

Valori limite del fattore di trasmissione solare totale g_{gl+sh} chiusure trasparenti in presenza di schermature solari mobili installate su fronti dell'edificio SUD, EST, OVEST, SUD-EST, SUD-OVEST

| ZONA CLIMATICA CLIMATIC ZONE | g_{gl+sh} |
|---------------------------------------|-------------|
| | 2021 |
| Zone TUTTE ALL ZONES | 0.35 |

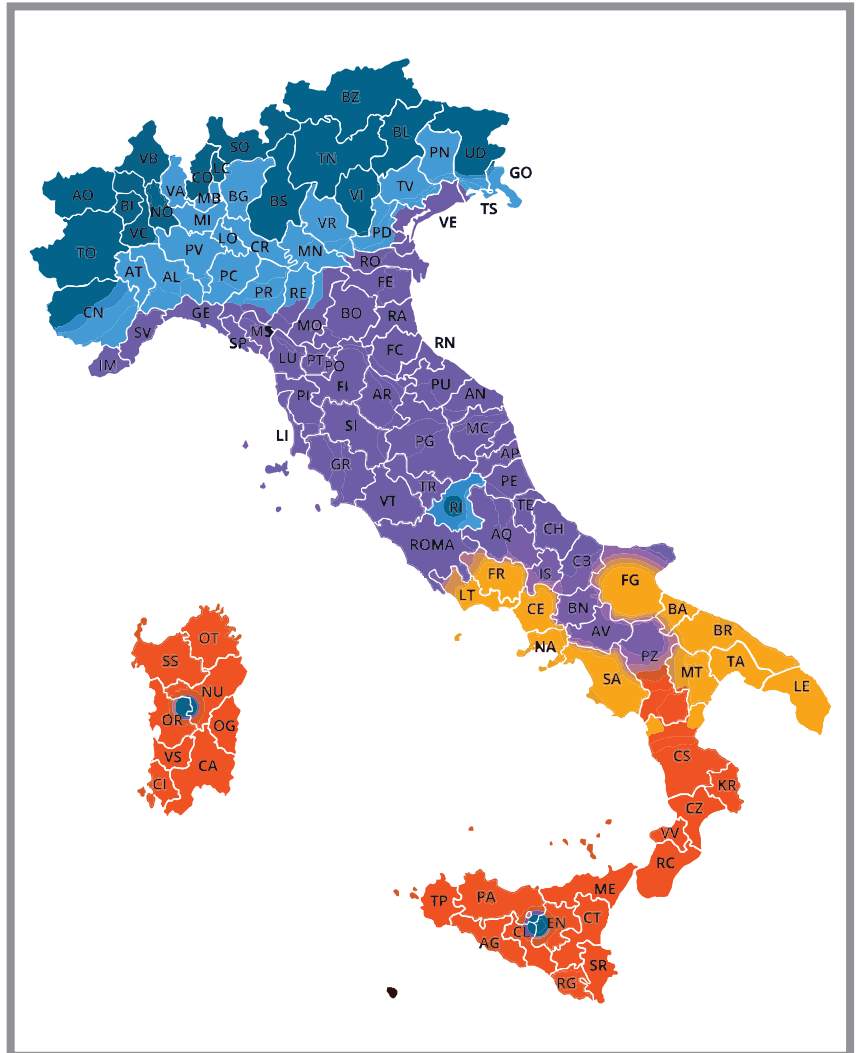



Valutazione della prestazione termica posseduta dai serramenti.

La trasmittanza termica rappresenta il parametro più significativo per la valutazione del comportamento termico di un prodotto edilizio: minore è il suo valore migliore è la prestazione termica posseduta dal componente stesso.

Il calcolo semplificato della trasmittanza termica del componente finestrato U_w composta da un singolo serramento e relativo vetro (o pannello) si esegue con la formula:

$$U_w = \frac{A_g U_g + A_f U_f + l g \varnothing g}{A_g + A_f}$$

dove:

A_g è l'area del vetro in mq;

U_g è il valore di trasmittanza termica riferito all'area centrale della vetrata, e non include l'effetto del distanziatore del vetro lungo il bordo della vetrata stessa;

A_f è l'area del telaio;

U_f è il valore di trasmittanza termica del telaio applicabile in assenza della vetrata;

$l g$ è la lunghezza del perimetro del vetro;

$\varnothing g$ è il valore di trasmittanza termica lineare concernente la conduzione di calore supplementare che avviene a causa dell'interazione tra telaio, vetri e distanziatore dei vetri in funzione delle proprietà termiche di ognuno di questi componenti e si rileva, secondo quanto precisato nell'allegato E della norma UNI EN ISO 10077-1, preferibilmente con il calcolo numerico eseguito in accordo con la norma ISO 10077-2; quando non sono disponibili i risultati di calcolo dettagliati ci si può riferire ai prospetti E.1 ed E.2 i quali indicano i valori $\varnothing g$ di default per le tipiche combinazioni di telai, vetri e distanziatori.

Estendibilità

L'appendice F della norma di prodotto UNI EN 14351-1 suggerisce le tipologie di serramento rappresentative e le relative estensioni, ma essendo la tabella puramente informativa, sta allo stesso produttore scegliere i campioni.

| Tipo di finestre | Estensione possibile |
|--------------------------------------------------------------|--------------------------------------------------------------|
| Fisso | |
| Finestra ad una anta (apertura interna o esterna) | Finestra ad anta ribalta |
| Finestra ad anta ribalta | |
| Finestra ad due o più ante (apertura interna o esterna) | Finestra ad due o più ante |
| Finestra a una o due ante orizzontali scorrevoli | |
| Finestra a due ante orizzontali scorrevoli | Finestra a due ante orizzontali scorrevoli |
| Finestra a una o due ante orizzontali scorrevoli con ribalta | Finestra a una o due ante orizzontali scorrevoli con ribalta |
| Bilico orizzontale o verticale | Bilico orizzontale o verticale |
| Finestra a soffietto | Finestra a soffietto |

La norma UNI EN 14351-1 prevede che il calcolo effettuato su di un serramento aventi dimensioni:

1230 ($\pm 25\%$) x 1480 (-25%)

1480 ($+25\%$) x 2180 ($\pm 25\%$)

Le analisi termiche effettuate con le misure sopra descritte, possono essere estese a tutti i serramenti di tutte le dimensioni, purché il vetro utilizzato abbia come valore di U_g uguale o inferiore a $1.9 \text{ w/m}^2\text{K}$, altrimenti la norma delle regole di estensione dei valori calcolati sull'infisso normalizzato ad infissi di diverse dimensioni.

Ovviamente i calcoli devono essere effettuati sulle stesse tipologie di infissi, e s'intende che una modifica del componente modifica la caratteristica in questione. In termini di prestazioni termiche è ovvio che andando a togliere o ad aggiungere elementi (per esempio passare da una finestra ad una anta, ad una a due e così via), determina una variazione dei valori finali.



vers.01

Serie

CX 600

Gruppo

A

Tav.

15

**Diagramma dei limiti di impiego per infissi a 2 ante
deflessione del nodo centrale**

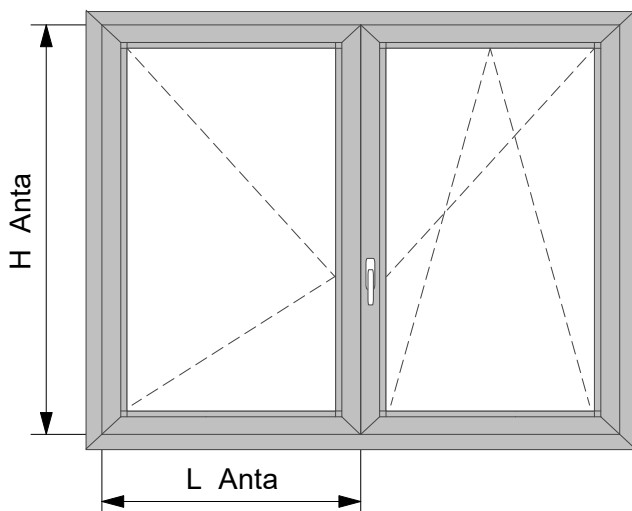
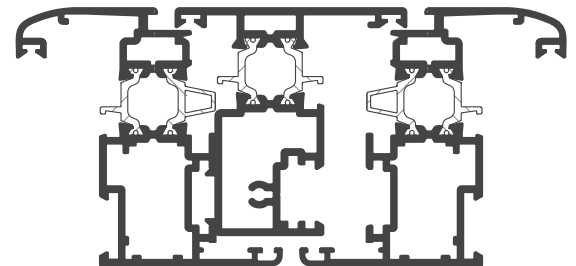
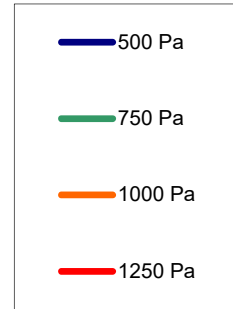
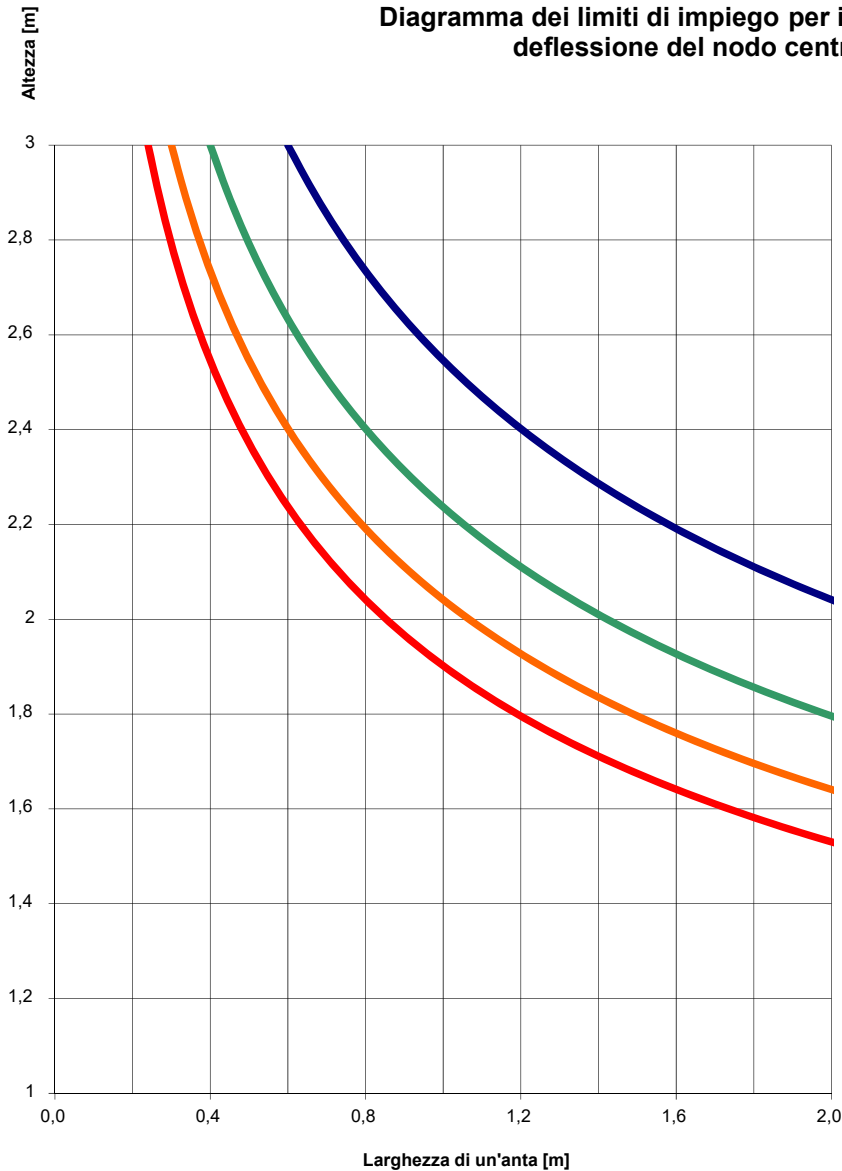

Il dimensionamento risultante dal grafico è solo indicativo.

Il progettista o il serramentista, nel determinare le dimensioni massime dei serramenti, dovrà considerare e valutare, oltre le dimensioni ed il momento d'inerzia dei profilati, anche le caratteristiche applicative e meteorologiche quali l'altezza dal suolo, l'esposizione alla pioggia e la velocità dei venti nella zona. Per questi dati consigliamo di consultare e seguire le "Raccomandazioni UNCSAAL" elaborate sulla base delle norme UNI, UNI-EN e UNI-CNR esistenti in merito.

Verificare che la freccia del profilato sia compatibile con quella del vetro utilizzato.
Le curve rappresentano la larghezza massima dell'anta in funzione della sua altezza e della pressione del vento.
Il serramento è considerato a 2 ante uguali.
Le curve sono calcolate sulla base della deformazione elastica di **1/300** dell'altezza del serramento.



**Diagramma dei limiti di impiego per infissi a 2 ante
deflessione del nodo centrale**

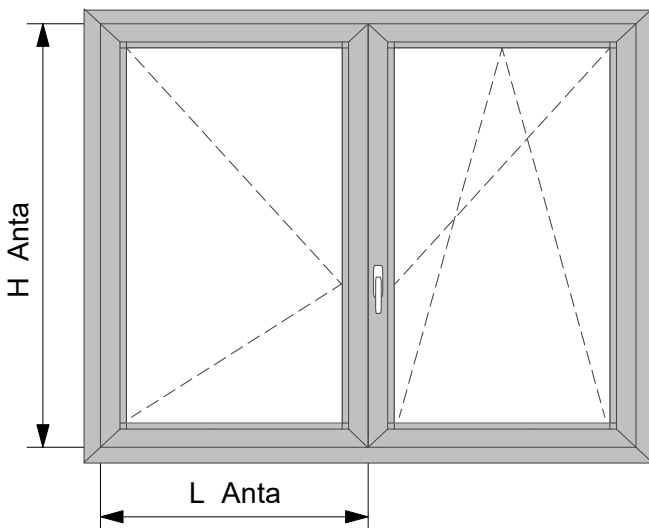
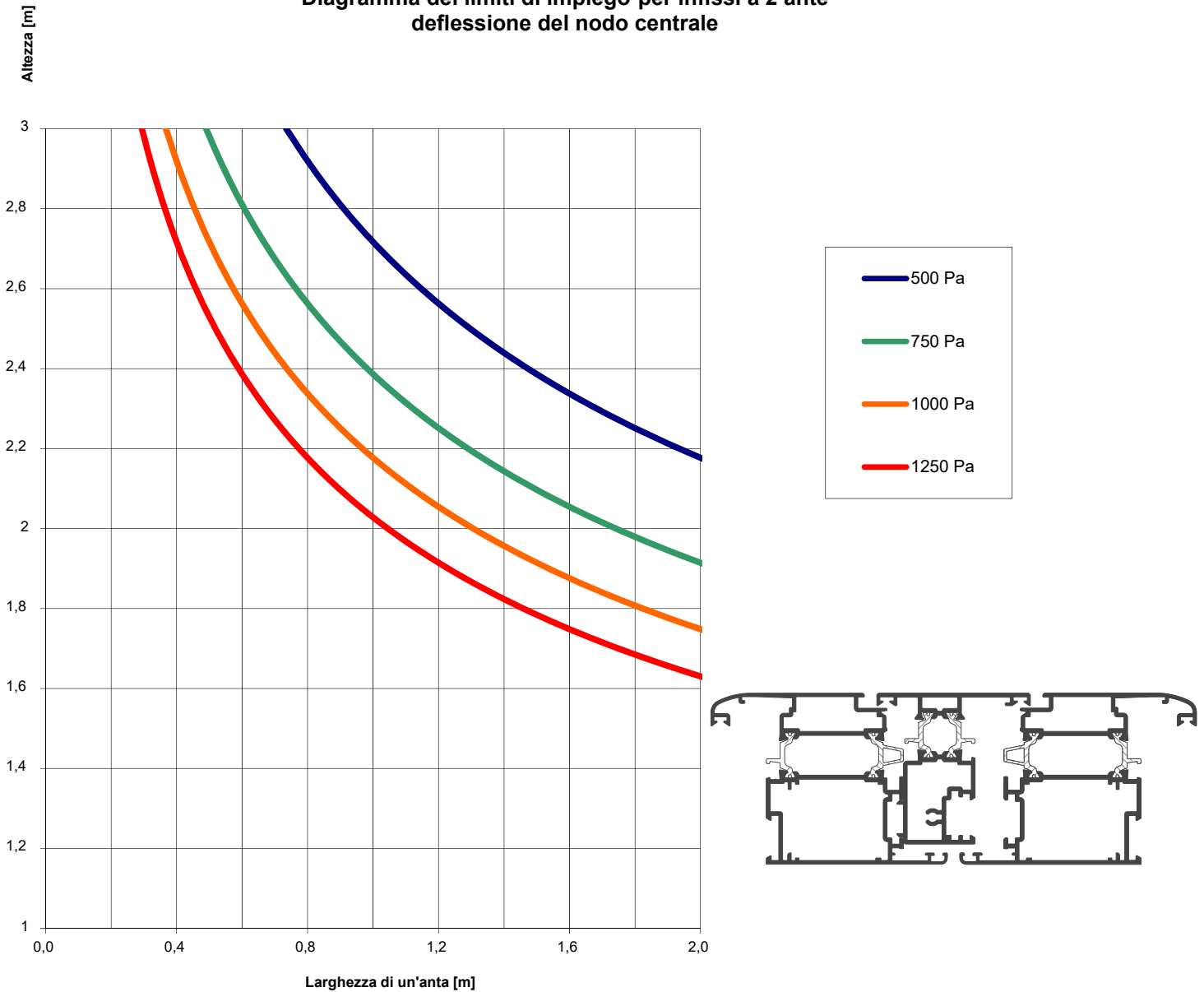

Il dimensionamento risultante dal grafico è solo indicativo.

Il progettista o il serramentista, nel determinare le dimensioni massime dei serramenti, dovrà considerare e valutare, oltre le dimensioni ed il momento d'inerzia dei profilati, anche le caratteristiche applicative e meteorologiche quali l'altezza dal suolo, l'esposizione alla pioggia e la velocità dei venti nella zona. Per questi dati consigliamo di consultare e seguire le "Raccomandazioni UNCSAAL" elaborate sulla base delle norme UNI, UNI-EN e UNI-CNR esistenti in merito.

Verificare che la freccia del profilato sia compatibile con quella del vetro utilizzato.

Le curve rappresentano la larghezza massima dell'anta in funzione della sua altezza e della pressione del vento.

Il serramento è considerato a 2 ante uguali.

Le curve sono calcolate sulla base della deformazione elastica di **1/300** dell'altezza del serramento.

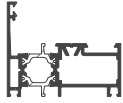
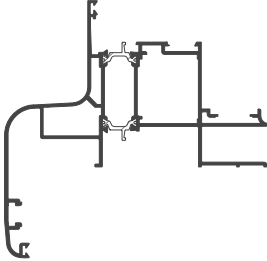
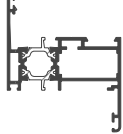
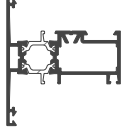
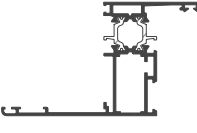
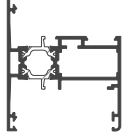
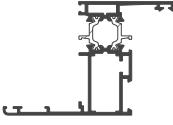
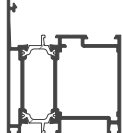
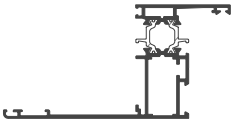
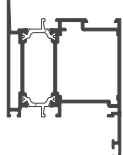
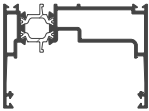
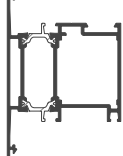
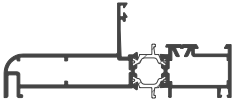
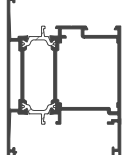
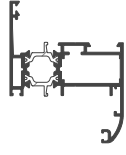

| | | | |
|----------------------------------------------------------------------------------------------------------------------------------------------------------------------------------------------------------------------|-----------------------------------------------------------------------------------------------------|----------------------------------------------------------------------------------------------------------------------------------------------------------------------------------------------------------------------------|-------------------------------------------------------------------------------------------------------|
| CX60.101 Telaio ad L piccolo Peso kg/ml. 1.211 Jx 17.07 cm ⁴ Wx 5.04 cm ³ Jy 5.28 cm ⁴ Wy 1.64 cm ³ |  Tavola 10 | CX60.109 Telaio per capannoni Peso kg/ml. 2.937 Jx 163.60 cm ⁴ Wx 20.52 cm ³ Jy 85.16 cm ⁴ Wy 11.55 cm ³ |  Tavola 35 |
| CX60.102 Telaio a Z piccolo Peso kg/ml. 1.290 Jx 20.94 cm ⁴ Wx 6.76 cm ³ Jy 8.40 cm ⁴ Wy 2.28 cm ³ |  Tavola 10 | | |
| CX60.103 Telaio a T piccolo Peso kg/ml. 1.325 Jx 19.41 cm ⁴ Wx 5.36 cm ³ Jy 8.96 cm ⁴ Wy 2.43 cm ³ |  Tavola 10 | CX60.110 Telaio a Z aletta battuta 54 mm. Peso kg/ml. 1.444 Jx 25,45 cm ⁴ Wx 7,82 cm ³ Jy 23,22 cm ⁴ Wy 3,71 cm ³ |  Tavola 12 |
| CX60.104 Telaio ad h piccolo-soglia Peso kg/ml. 1.404 Jx 23.87 cm ⁴ Wx 7.14 cm ³ Jy 11.46 cm ⁴ Wy 3.05 cm ³ |  Tavola 10 | CX60.111 Telaio a Z aletta battuta 40 mm. Peso kg/ml. 1.383 Jx 23.78 cm ⁴ Wx 7.61 cm ³ Jy 15,00 cm ⁴ Wy 2,91 cm ³ |  Tavola 12 |
| CX60.105 Telaio ad L grande Peso kg/ml. 1.605 Jx 24.82 cm ⁴ Wx 7.21 cm ³ Jy 20.35 cm ⁴ Wy 4.58 cm ³ |  Tavola 11 | CX60.112 Telaio a Z aletta battuta 70 mm. Peso kg/ml. 1.539 Jx 29,91 cm ⁴ Wx 8,34 cm ³ Jy 37,49 cm ⁴ Wy 5,05 cm ³ |  Tavola 12 |
| CX60.106 Telaio a Z grande Peso kg/ml. 1.715 Jx 28.96 cm ⁴ Wx 9.01 cm ³ Jy 26.76 cm ⁴ Wy 5.49 cm ³ |  Tavola 11 | XX60.113 Telaio di compensazione Peso kg/ml. 1.466 Jx 40,76 cm ⁴ Wx 10,33 cm ³ Jy 10,97 cm ⁴ Wy 3,04 cm ³ |  Tavola 12 |
| CX60.107 Telaio a T grande Peso kg/ml. 1.712 Jx 27.12 cm ⁴ Wx 7.51 cm ³ Jy 27.36 cm ⁴ Wy 5.62 cm ³ |  Tavola 11 | CX60.116 Semi-Pilastrino Peso kg/ml. 1.804 Jx 00.00 cm ⁴ Wx 0.00 cm ³ Jy 00.00 cm ⁴ Wy 0.00 cm ³ |  Tavola 14 |
| CX60.108 Telaio ad h grande Peso kg/ml. 1.882 Jx 31.72 cm ⁴ Wx 9.36 cm ³ Jy 32.93 cm ⁴ Wy 6.61 cm ³ |  Tavola 11 | CX60.117 Telaio Z piccolo rientro m.11.5 Peso kg/ml. 1.354 Jx 21.68 cm ⁴ Wx 6.92 cm ³ Jy 8.79 cm ⁴ Wy 2.45 cm ³ |  Tavola 14 |

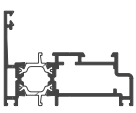
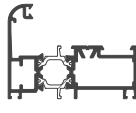
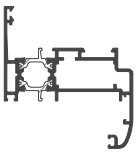
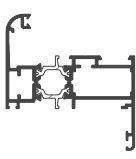
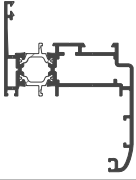
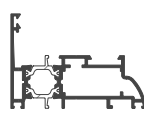
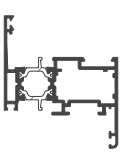
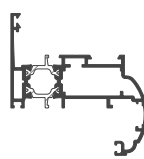
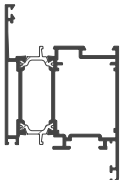
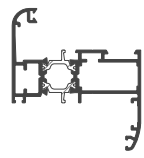
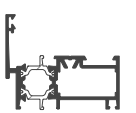
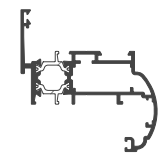
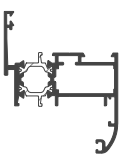
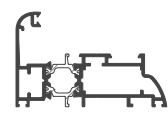
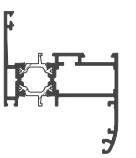
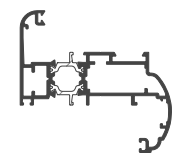

| | | | | | |
|-----------------------------------------------------------------------------------------------------------------------------------------------------------------------------------------------------------------------------|-------------------------------------------------------------------------------------|--------------|------------------------------------------------------------------------------------------------------------------------------------------------------------------------------------------------------------------------------|---------------------------------------------------------------------------------------|--------------|
| CX60.119 Tel. a L complanare piccolo Peso kg/ml. 1.243 Jx 00.00 cm ⁴ Wx 0.00 cm ³ Jy 00.00 cm ⁴ Wy 0.00 cm ³ |  | Tavola 15 | CX60.152 Telaio bombato ad L piccolo Peso kg/ml. 1.357 Jx 24.72 cm ⁴ Wx 7.36 cm ³ Jy 6.40 cm ⁴ Wy 2.29 cm ³ |  | Tavola 16 |
| CX60.120 Tel. Z compl. picc. aletta 25 mm Peso kg/ml. 1.417 Jx 00.00 cm ⁴ Wx 0.00 cm ³ Jy 00.00 cm ⁴ Wy 0.00 cm ³ |  | Tavola 15 | CX60.153 Telaio bombato a Z piccolo Peso kg/ml. 1.436 Jx 29.85 cm ⁴ Wx 8.42 cm ³ Jy 10.99 cm ⁴ Wy 2.98 cm ³ |  | Tavola 16 |
| CX60.121 Tel. Z compl. picc. aletta 40 mm Peso kg/ml. 1.499 Jx 00.00 cm ⁴ Wx 0.00 cm ³ Jy 00.00 cm ⁴ Wy 0.00 cm ³ |  | Tavola 15 | CX60.155 Tel. a L ornamentale piccolo Peso kg/ml. 1.268 Jx 00.00 cm ⁴ Wx 0.00 cm ³ Jy 00.00 cm ⁴ Wy 0.00 cm ³ |  | Tavola 13 |
| CX60.122 Telaio / anta piccolo Peso kg/ml. 1.341 Jx 00.00 cm ⁴ Wx 0.00 cm ³ Jy 00.00 cm ⁴ Wy 0.00 cm ³ |  | Tavola 15 | CX60.156 Tel. Z ornam. picc. aletta 25 mm Peso kg/ml. 1.454 Jx 00.00 cm ⁴ Wx 0.00 cm ³ Jy 00.00 cm ⁴ Wy 0.00 cm ³ |  | Tavola 13 |
| CX60.123 Telaio / anta grande Peso kg/ml. 1.755 Jx 00.00 cm ⁴ Wx 0.00 cm ³ Jy 00.00 cm ⁴ Wy 0.00 cm ³ |  | Tavola 15 | CX60.157 Telaio bombato a Z rientrato picc. Peso kg/ml. 1.471 Jx 30.54 cm ⁴ Wx 8.88 cm ³ Jy 13.42 cm ⁴ Wy 3.75 cm ³ |  | Tavola 16 |
| CX60.124 Telaio a L piccolo ridotto Peso kg/ml. 1.182 Jx 00.00 cm ⁴ Wx 0.00 cm ³ Jy 00.00 cm ⁴ Wy 0.00 cm ³ |  | Tavola 14 | CX60.160 Telaio bombato a Z rientrato picc. Peso kg/ml. 1.425 Jx 26.61 cm ⁴ Wx 7.17 cm ³ Jy 11.87 cm ⁴ Wy 3.13 cm ³ |  | Tavola 17 |
| CX60.125 Tel Z picc.ridotto rientro mm.11.5 Peso kg/ml. 1.325 Jx 20.48 cm ⁴ Wx 6.83 cm ³ Jy 8.40 cm ⁴ Wy 2.20 cm ³ |  | Tavola 14 | CX60.161 Telaio bombato a Z rientrato picc. Peso kg/ml. 1.414 Jx 31.03 cm ⁴ Wx 6.55 cm ³ Jy 7.44 cm ⁴ Wy 2.29 cm ³ |  | Tavola 17 |
| CX60.127 Tel. Z picc.ridotto rientro mm.8 Peso kg/ml. 1.325 Jx 21.68 cm ⁴ Wx 6.95 cm ³ Jy 8.94 cm ⁴ Wy 2.50 cm ³ |  | Tavola 21 | CX60.162 Telaio bombato a Z rientrato picc. Peso kg/ml. 1.600 Jx 39.96 cm ⁴ Wx 9.58 cm ³ Jy 14.27 cm ⁴ Wy 3.73 cm ³ |  | Tavola 17 |







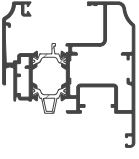
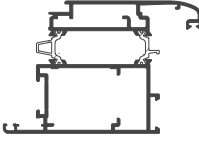
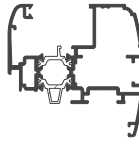
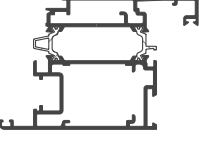
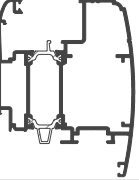
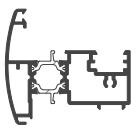
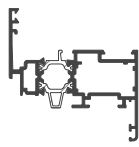
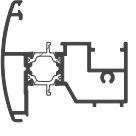
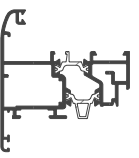
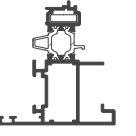
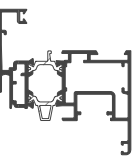
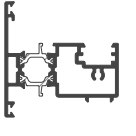
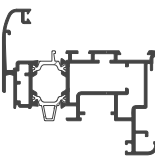
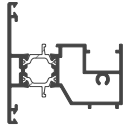
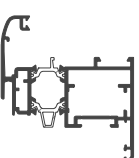
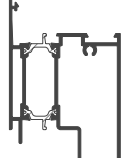



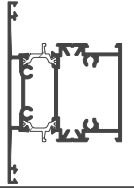

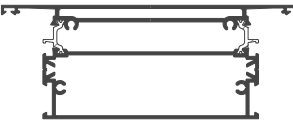
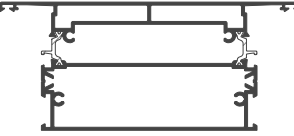
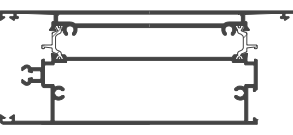

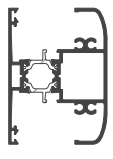

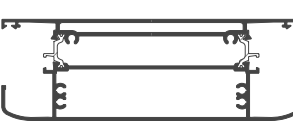
| | | | | | |
|-----------------------------------------------------------------------------------------------------------------------------------------------------------------------------------------------------------------------------------------------|--|-------------------|------------------------------------------------------------------------------------------------------------------------------------------------------------------------------------------------------------------------------------------------|--|-------------------|
| <p>XX60.163</p> <p>Telaio compensazione</p> <p>Peso kg/ml. 1.196</p> <p>Jx 31.02 cm⁴ Wx 8.16 cm³</p> <p>Jy 9.24 cm⁴ Wy 2.44 cm³</p> | | Tavola 16 | <p>CX60.206</p> <p>Anta tonda grande v/infilare</p> <p>Peso kg/ml. 2.011</p> <p>Jx 40.47 cm⁴ Wx 11.52 cm³</p> <p>Jy 39.59 cm⁴ Wy 7.83 cm³</p> | | Tavola 19 |
| <p>CX60.172</p> <p>Telaio a Z aletta battuta 32 mm.</p> <p>Peso kg/ml. 1.359</p> <p>Jx 22.88 cm⁴ Wx 7.50 cm³</p> <p>Jy 11.99 cm⁴ Wy 2.68 cm³</p> | | Tavola 13 | <p>CX60.207</p> <p>Anta apertura bilico</p> <p>Peso kg/ml. 2.010</p> <p>Jx 38.01 cm⁴ Wx 9.32 cm³</p> <p>Jy 37.93 cm⁴ Wy 7.45 cm³</p> | | Tavola 29 |
| <p>CX60.175</p> <p>Telaio a Z ELEGANCE</p> <p>Peso kg/ml. 1.368</p> <p>Jx 00.00 cm⁴ Wx 0.00 cm³</p> <p>Jy 00.00 cm⁴ Wy 0.00 cm³</p> | | Tavola 13 | <p>CX60.209</p> <p>Anta picc. ellittica v/infilare</p> <p>Peso kg/ml. 1.667</p> <p>Jx 00.00 cm⁴ Wx 00.00 cm³</p> <p>Jy 00.00 cm⁴ Wy 00.00 cm³</p> | | Tavola 19 |
| <p>CX60.201</p> <p>Anta tonda piccola c/fermavetro</p> <p>Peso kg/ml. 1.449</p> <p>Jx 26.79 cm⁴ Wx 7.85 cm³</p> <p>Jy 9.96 cm⁴ Wy 2.80 cm³</p> | | Tavola 18 | <p>CX60.210</p> <p>Anta grande ellittica v/infilare</p> <p>Peso kg/ml. 2.151</p> <p>Jx 40.97 cm⁴ Wx 12.68 cm³</p> <p>Jy 40.34 cm⁴ Wy 8.63 cm³</p> | | Tavola 17 9 |
| <p>CX60.202</p> <p>Anta tonda grande c/fermavetro</p> <p>Peso kg/ml. 1.877</p> <p>Jx 36.73 cm⁴ Wx 10.49 cm³</p> <p>Jy 31.00 cm⁴ Wy 6.51 cm³</p> | | Tavola 18 | <p>CX60.215</p> <p>Anta diritta piccola c/fermavetro</p> <p>Peso kg/ml. 1.470</p> <p>Jx 26.99 cm⁴ Wx 8.01 cm³</p> <p>Jy 10.11 cm⁴ Wy 2.84 cm³</p> | | Tavola 21 |
| <p>CX60.203</p> <p>Anta tonda piccola v/infilare</p> <p>Peso kg/ml. 1.571</p> <p>Jx 30.51 cm⁴ Wx 8.36 cm³</p> <p>Jy 14.47 cm⁴ Wy 3.76 cm³</p> | | Tavola 19 | <p>CX60.225</p> <p>Anta ornamentale ferr.nastro</p> <p>Peso kg/ml. 2.363</p> <p>Jx 53.11 cm⁴ Wx 20.35 cm³</p> <p>Jy 26.22 cm⁴ Wy 7.88 cm³</p> | | Tavola 24 |
| <p>CX60.204</p> <p>Anta tonda piccola f/nastro</p> <p>Peso kg/ml. 1.710</p> <p>Jx 34.02 cm⁴ Wx 9.43 cm³</p> <p>Jy 14.63 cm⁴ Wy 3.71 cm³</p> | | Tavola 23 | <p>CX60.226</p> <p>Anta diritta grande c/fermavetro</p> <p>Peso kg/ml. 1.898</p> <p>Jx 39.42 cm⁴ Wx 11.31 cm³</p> <p>Jy 31.88 cm⁴ Wy 6.99 cm³</p> | | Tavola 21 |
| <p>CX60.205</p> <p>Anta apertura esterna</p> <p>Peso kg/ml. 1.960</p> <p>Jx 37.33 cm⁴ Wx 10.08 cm³</p> <p>Jy 33.26 cm⁴ Wy 6.87 cm³</p> | | Tavola 23 9 | <p>CX60.227</p> <p>Anta doppia battuta grande</p> <p>Peso kg/ml. 1.877</p> <p>Jx 36.77 cm⁴ Wx 10.74 cm³</p> <p>Jy 32.33 cm⁴ Wy 6.41 cm³</p> | | Tavola 22 |

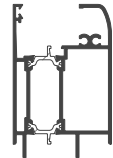

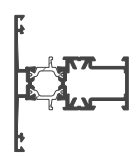
| | | | | | |
|--------------------------------------------------------------------------------------------------------------------------------------------------------------------------------------------------------------------------------------------------|-------------------------------------------------------------------------------------|-------------------------|-----------------------------------------------------------------------------------------------------------------------------------------------------------------------------------------------------------------------------------------------|---------------------------------------------------------------------------------------|-------------------------|
| <p>XX60.230</p> <p>Anta ornamentale ferr.nastro</p> <p>Peso kg/ml. 1.990</p> <p>Jx 38.99 cm⁴ Wx 10.63 cm³</p> <p>Jy 22.31 cm⁴ Wy 5.17 cm³</p> |  | <p>Tavola</p> <p>23</p> | <p>CX60.261</p> <p>Anta grande sormonto int. 10 mm</p> <p>Peso kg/ml. 2.233</p> <p>Jx 48.28 cm⁴ Wx 13.18 cm³</p> <p>Jy 46.95 cm⁴ Wy 8.94 cm³</p> |  | <p>Tavola</p> <p>25</p> |
| <p>CX60.232</p> <p>Anta picc. ornamentale v/infilare</p> <p>Peso kg/ml. 1.671</p> <p>Jx 00.00 cm⁴ Wx 00.00 cm³</p> <p>Jy 00.00 cm⁴ Wy 00.00 cm³</p> |  | <p>Tavola</p> <p>20</p> | <p>CX60.262</p> <p>Anta dritta grande f/nastro</p> <p>Peso kg/ml. 2.385</p> <p>Jx 51.43 cm⁴ Wx 14.11 cm³</p> <p>Jy 53.66 cm⁴ Wy 9.93 cm³</p> |  | <p>Tavola</p> <p>24</p> |
| <p>CX60.233</p> <p>Anta grande ornamen. v/infilare</p> <p>Peso kg/ml. 2.155</p> <p>Jx 00.00 cm⁴ Wx 00.00 cm³</p> <p>Jy 00.00 cm⁴ Wy 00.00 cm³</p> |  | <p>Tavola</p> <p>20</p> | <p>CX60.301</p> <p>Riporto tondo</p> <p>Peso kg/ml. 1.395</p> <p>Jx 23.31 cm⁴ Wx 6.48 cm³</p> <p>Jy 8.21 cm⁴ Wy 2.33 cm³</p> |  | <p>Tavola</p> <p>18</p> |
| <p>CX60.235</p> <p>Anta dritta rientro 5 mm.</p> <p>Peso kg/ml. 1.413</p> <p>Jx 00.00 cm⁴ Wx 00.00 cm³</p> <p>Jy 00.00 cm⁴ Wy 00.00 cm³</p> |  | <p>Tavola</p> <p>22</p> | <p>XX60.302</p> <p>Riporto tondo f/nastro</p> <p>Peso kg/ml. 1.386</p> <p>Jx 23.91 cm⁴ Wx 6.49 cm³</p> <p>Jy 9.49 cm⁴ Wy 2.59 cm³</p> |  | <p>Tavola</p> <p>23</p> |
| <p>CX60.237</p> <p>Anta piccola apertura esterna</p> <p>Peso kg/ml. 1.617</p> <p>Jx 28.68 cm⁴ Wx 7.41 cm³</p> <p>Jy 13.17 cm⁴ Wy 3.51 cm³</p> |  | <p>Tavola</p> <p>24</p> | <p>CX60.303</p> <p>Riporto/inversione bilico</p> <p>Peso kg/ml. 1.288</p> <p>Jx 18.93 cm⁴ Wx 4.76 mm³</p> <p>Jy 6.92 cm⁴ Wy 2.10 mm³</p> |  | <p>Tavola</p> <p>31</p> |
| <p>CX60.238</p> <p>Anta dritta piccola f/nastro</p> <p>Peso kg/ml. 1.728</p> <p>Jx 34.54 cm⁴ Wx 9.64 cm³</p> <p>Jy 15.39 cm⁴ Wy 3.83 cm³</p> |  | <p>Tavola</p> <p>24</p> | <p>CX60.304</p> <p>Riporto dritto</p> <p>Peso kg/ml. 1.329</p> <p>Jx 23.32 cm⁴ Wx 6.38 cm³</p> <p>Jy 9.37 cm⁴ Wy 2.59 cm³</p> |  | <p>Tavola</p> <p>18</p> |
| <p>CX60.242</p> <p>Anta f/nastro ELEGANCE</p> <p>Peso kg/ml. 1.993</p> <p>Jx 00.00 cm⁴ Wx 0.00 cm³</p> <p>Jy 00.00 cm⁴ Wy 0.00 cm³</p> |  | <p>Tavola</p> <p>24</p> | <p>XX60.308</p> <p>Riporto dritto f/nastro</p> <p>Peso kg/ml. 1.333</p> <p>Jx 23.91 cm⁴ Wx 6.49 cm³</p> <p>Jy 9.49 cm⁴ Wy 2.59 cm³</p> |  | <p>Tavola</p> <p>23</p> |
| <p>CX60.260</p> <p>Anta piccola sormonto int. 10 mm</p> <p>Peso kg/ml. 1.686</p> <p>Jx 34.97 cm⁴ Wx 9.77 cm³</p> <p>Jy 14.90 cm⁴ Wy 3.88 cm³</p> |  | <p>Tavola</p> <p>25</p> | <p>CX60.401</p> <p>Soprazoccolo</p> <p>Peso kg/ml. 1.895</p> <p>Jx 31.05 cm⁴ Wx 9.62 mm³</p> <p>Jy 39.08 cm⁴ Wy 7.72 mm³</p> |  | <p>Tavola</p> <p>27</p> |



| | | | | | |
|---------------------------------------------------------------------------------------------------------------------------------------------------------------------------------------------------------------------------------------------|-------------------------------------------------------------------------------------|-------------------------|--------------------------------------------------------------------------------------------------------------------------------------------------------------------------------------------------------------------------------------------|---------------------------------------------------------------------------------------|-------------------------|
| <p>CX60.402</p> <p>Traverso mm.96</p> <p>Peso kg/ml. 1.990</p> <p>Jx 29.70 cm⁴ Wx 8.45 mm³</p> <p>Jy 31.45 cm⁴ Wy 6.55 mm³</p> |  | <p>Tavola</p> <p>27</p> | <p>XX60.414</p> <p>Soglia bassa per porte</p> <p>Peso kg/ml. 0.966</p> <p>Jx 00.00 cm⁴ Wx 00.00 cm³</p> <p>Jy 00.00 cm⁴ Wy 00.00 cm³</p> |  | <p>Tavola</p> <p>28</p> |
| <p>CX60.403</p> <p>Fascia mm. 158</p> <p>Peso kg/ml. 3.169</p> <p>Jx 50.80 cm⁴ Wx 14.14 cm³</p> <p>Jy 192.25 cm⁴ Wy 24.33 cm³</p> |  | <p>Tavola</p> <p>28</p> | <p>CX60.415</p> <p>Fascia compl. da 68 x 158 mm.</p> <p>Peso kg/ml. 3.222</p> <p>Jx 00.00 cm⁴ Wx 0.00 cm³</p> <p>Jy 00.00 cm⁴ Wy 0.00 cm³</p> |  | <p>Tavola</p> <p>22</p> |
| <p>CX60.404</p> <p>Zoccolo mm. 158</p> <p>Peso kg/ml. 3.292</p> <p>Jx 55.42 cm⁴ Wx 15.97 cm³</p> <p>Jy 215.03 cm⁴ Wy 25.75 cm³</p> |  | <p>Tavola</p> <p>28</p> | <p>CX70.521</p> <p>Fermavetro tondo mm. 14</p> <p>Peso kg/ml. 0.266</p> <p>Jx 00.00 cm⁴ Wx 00.00 cm³</p> <p>Jy 00.00 cm⁴ Wy 00.00 cm³</p> |  | <p>Tavola</p> <p>38</p> |
| <p>XX60.405</p> <p>Traverso v/infilare mm. 72</p> <p>Peso kg/ml. 1.653</p> <p>Jx 21.20 cm⁴ Wx 7.75 cm³</p> <p>Jy 20.33cm⁴ Wy 5.65 cm³</p> |  | <p>Tavola</p> <p>26</p> | <p>CX70.522</p> <p>Fermavetro tondo mm. 18</p> <p>Peso kg/ml. 0.277</p> <p>Jx 00.00 cm⁴ Wx 00.00 cm³</p> <p>Jy 00.00 cm⁴ Wy 00.00 cm³</p> |  | <p>Tavola</p> <p>38</p> |
| <p>XX60.406</p> <p>Traverso v/infilare mm. 158</p> <p>Peso kg/ml. 3.360</p> <p>Jx 46.90 cm⁴ Wx 16.11 cm³</p> <p>Jy 232.81 cm⁴ Wy 29.46 cm³</p> |  | <p>Tavola</p> <p>26</p> | <p>CX70.523</p> <p>Fermavetro tondo mm. 22</p> <p>Peso kg/ml. 0.294</p> <p>Jx 00.00 cm⁴ Wx 00.00 cm³</p> <p>Jy 00.00 cm⁴ Wy 00.00 cm³</p> |  | <p>Tavola</p> <p>38</p> |
| <p>XX60.407</p> <p>Soprazoccolo v/infilare mm. 96</p> <p>Peso kg/ml. 1.808</p> <p>Jx 22.55 cm⁴ Wx 8.25 cm³</p> <p>Jy 30.82 cm⁴ Wy 7.48 cm³</p> |  | <p>Tavola</p> <p>26</p> | <p>CX70.524</p> <p>Fermavetro tondo mm. 26</p> <p>Peso kg/ml. 0.314</p> <p>Jx 00.00 cm⁴ Wx 00.00 cm³</p> <p>Jy 00.00 cm⁴ Wy 00.00 cm³</p> |  | <p>Tavola</p> <p>38</p> |
| <p>CX60.408</p> <p>Traverso piccolo mm. 72</p> <p>Peso kg/ml. 1.404</p> <p>Jx 19.53 cm⁴ Wx 5.45 cm³</p> <p>Jy 9.52 cm⁴ Wy 2.64 cm³</p> |  | <p>Tavola</p> <p>31</p> | <p>CX70.525</p> <p>Fermavetro tondo mm. 30</p> <p>Peso kg/ml. 0.350</p> <p>Jx 00.00 cm⁴ Wx 00.00 cm³</p> <p>Jy 00.00 cm⁴ Wy 00.00 cm³</p> |  | <p>Tavola</p> <p>38</p> |
| <p>CX60.409</p> <p>Soglia bassa</p> <p>Peso kg/ml. 0.785</p> <p>Jx 14.28 cm⁴ Wx 3,91 cm³</p> <p>Jy 0,60 cm⁴ Wy 0,41 cm³</p> |  | <p>Tavola</p> <p>13</p> | <p>CX70.526</p> <p>Fermavetro diritto mm. 14</p> <p>Peso kg/ml. 0.279</p> <p>Jx 00.00 cm⁴ Wx 00.00 cm³</p> <p>Jy 00.00 cm⁴ Wy 00.00 cm³</p> |  | <p>Tavola</p> <p>39</p> |









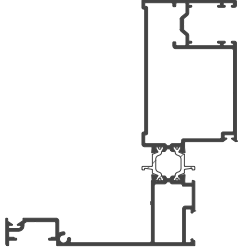
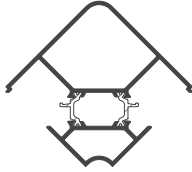

| | | | | | |
|----------------------------------------------------------------------------------------------------------------------------------------------------------------------------------------------|--|--------------|------------------------------------------------------------------------------------------------------------------------------------------------------------------------------------------------|--|--------------|
| <p>CX70.527</p> <p>Fermavetro diritto mm. 18</p> <p>Peso kg/ml. 0.290</p> <p>Jx 00.00 cm4 Wx 00.00 cm3</p> <p>Jy 00.00 cm4 Wy 00.00 cm3</p> | | Tavola 39 | <p>CX70.539</p> <p>Fermavetro diritto mm. 10</p> <p>Peso kg/ml. 0.245</p> <p>Jx 00.00 cm4 Wx 0.00 cm3</p> <p>Jy 00.00 cm4 Wy 0.00 cm3</p> | | Tavola 39 |
| <p>CX70.528</p> <p>Fermavetro diritto mm. 22</p> <p>Peso kg/ml. 0.307</p> <p>Jx 00.00 cm4 Wx 0.00 cm3</p> <p>Jy 00.00 cm4 Wy 0.00 cm3</p> | | Tavola 39 | <p>CX70.562</p> <p>Fermavetro sicurezza mm. 14</p> <p>Peso kg/ml. 0.324</p> <p>Jx 00.00 cm4 Wx 00.00 cm3</p> <p>Jy 00.00 cm4 Wy 00.00 cm3</p> | | Tavola 41 |
| <p>CX70.529</p> <p>Fermavetro diritto mm. 26</p> <p>Peso kg/ml. 0.327</p> <p>Jx 00.00 cm4 Wx 0.00 cm3</p> <p>Jy 00.00 cm4 Wy 0.00 cm3</p> | | Tavola 39 | <p>CX70.563</p> <p>Fermavetro sicurezza mm. 18</p> <p>Peso kg/ml. 0.330</p> <p>Jx 00.00 cm4 Wx 00.00 cm3</p> <p>Jy 00.00 cm4 Wy 00.00 cm3</p> | | Tavola 41 |
| <p>CX70.530</p> <p>Fermavetro diritto mm. 30</p> <p>Peso kg/ml. 0.362</p> <p>Jx 00.00 cm4 Wx 0.00 cm3</p> <p>Jy 00.00 cm4 Wy 0.00 cm3</p> | | Tavola 39 | <p>CX70.564</p> <p>Fermavetro sicurezza mm. 22</p> <p>Peso kg/ml. 0.348</p> <p>Jx 00.00 cm4 Wx 0.00 cm3</p> <p>Jy 00.00 cm4 Wy 0.00 cm3</p> | | Tavola 41 |
| <p>CX70.531</p> <p>Fermavetro tondo mm. 35</p> <p>Peso kg/ml. 0.370</p> <p>Jx 00.00 cm4 Wx 0.00 cm3</p> <p>Jy 00.00 cm4 Wy 0.00 cm3</p> | | Tavola 38 | <p>CX70.565</p> <p>Fermavetro sicurezza mm. 26</p> <p>Peso kg/ml. 0.372</p> <p>Jx 00.00 cm4 Wx 0.00 cm3</p> <p>Jy 00.00 cm4 Wy 0.00 cm3</p> | | Tavola 41 |
| <p>CX70.532</p> <p>Fermavetro diritto mm. 35</p> <p>Peso kg/ml. 0.383</p> <p>Jx 00.00 cm4 Wx 0.00 cm3</p> <p>Jy 00.00 cm4 Wy 0.00 cm3</p> | | Tavola 39 | <p>CX70.566</p> <p>Fermavetro sicurezza mm. 30</p> <p>Peso kg/ml. 0.396</p> <p>Jx 00.00 cm4 Wx 0.00 cm3</p> <p>Jy 00.00 cm4 Wy 0.00 cm3</p> | | Tavola 41 |
| <p>CX70.533</p> <p>Fermavetro diritto mm. 5</p> <p>Peso kg/ml. 0.252</p> <p>Jx 00.00 cm4 Wx 0.00 cm3</p> <p>Jy 00.00 cm4 Wy 0.00 cm3</p> | | Tavola 39 | <p>CX70.567</p> <p>Fermavetro sicurezza mm. 35</p> <p>Peso kg/ml. 0.434</p> <p>Jx 00.00 cm4 Wx 0.00 cm3</p> <p>Jy 00.00 cm4 Wy 0.00 cm3</p> | | Tavola 41 |
| <p>CX70.537</p> <p>Fermavetro diritto mm. 40</p> <p>Peso kg/ml. 0.403</p> <p>Jx 00.00 cm4 Wx 0.00 cm3</p> <p>Jy 00.00 cm4 Wy 0.00 cm3</p> | | Tavola 39 | <p>CX70.568</p> <p>Fermavetro sicurezza mm. 10</p> <p>Peso kg/ml. 0.297</p> <p>Jx 00.00 cm4 Wx 0.00 cm3</p> <p>Jy 00.00 cm4 Wy 0.00 cm3</p> | | Tavola 41 |



| | | | | | |
|--------------------------------------------------------------------------------------------------------------------------------------------------------------------------------------------------|--|--------------|----------------------------------------------------------------------------------------------------------------------------------------------------------------------------------------------------|--|--------------|
| <p>CX70.571</p> <p>Fermavetro clips tondo mm. 14</p> <p>Peso kg/ml. 0.216</p> <p>Jx 00.00 cm4 Wx 00.00 cm3</p> <p>Jy 00.00 cm4 Wy 00.00 cm3</p> | | Tavola 40 | <p>XX70.603</p> <p>Soglia piatta da mm. 5</p> <p>Peso kg/ml. 0.275</p> <p>Jx 00.00 cm4 Wx 0.00 cm3</p> <p>Jy 00.00 cm4 Wy 0.00 cm3</p> | | Tavola 21 |
| <p>CX70.572</p> <p>Fermavetro clips tondo mm. 18</p> <p>Peso kg/ml. 0.262</p> <p>Jx 00.00 cm4 Wx 00.00 cm3</p> <p>Jy 00.00 cm4 Wy 00.00 cm3</p> | | Tavola 40 | <p>CX60.604</p> <p>Inversione di battuta</p> <p>Peso kg/ml. 1.119</p> <p>Jx 12.97 cm4 Wx 3.85 cm3</p> <p>Jy 4.77 cm4 Wy 1.50 cm3</p> | | Tavola 25 |
| <p>CX70.573</p> <p>Fermavetro clips tondo mm. 22</p> <p>Peso kg/ml. 0.283</p> <p>Jx 00.00 cm4 Wx 00.00 cm3</p> <p>Jy 00.00 cm4 Wy 00.00 cm3</p> | | Tavola 40 | <p>CX70.605</p> <p>Astina</p> <p>Peso kg/ml. 0.146</p> <p>Jx 0,00 cm4 Wx 0,00 cm3</p> <p>Jy 0,00 cm4 Wy 0,00 cm3</p> | | Tavola 18 |
| <p>CX70.574</p> <p>Fermavetro clips tondo mm. 26</p> <p>Peso kg/ml. 0.313</p> <p>Jx 00.00 cm4 Wx 00.00 cm3</p> <p>Jy 00.00 cm4 Wy 00.00 cm3</p> | | Tavola 40 | <p>XX70.606</p> <p>Scivolo esterno soglia bassa</p> <p>Peso kg/ml. 0.322</p> <p>Jx 0,00 cm4 Wx 0,00 cm3</p> <p>Jy 0,00 cm4 Wy 0,00 cm3</p> | | Tavola 13 |
| <p>CX70.575</p> <p>Fermavetro clips tondo mm. 30</p> <p>Peso kg/ml. 0.340</p> <p>Jx 00.00 cm4 Wx 00.00 cm3</p> <p>Jy 00.00 cm4 Wy 00.00 cm3</p> | | Tavola 40 | <p>XX70.607</p> <p>Scivolo interno soglia bassa</p> <p>Peso kg/ml. 0.224</p> <p>Jx 0,00 cm4 Wx 0,00 cm3</p> <p>Jy 0,00 cm4 Wy 0,00 cm3</p> | | Tavola 13 |
| <p>CX70.581</p> <p>Fermavetro clips tondo mm. 35</p> <p>Peso kg/ml. 0.361</p> <p>Jx 00.00 cm4 Wx 00.00 cm3</p> <p>Jy 00.00 cm4 Wy 00.00 cm3</p> | | Tavola 40 | <p>RX70.609</p> <p>Prof. di chiusura rinforzo montanti</p> <p>Peso kg/ml. 0.393</p> <p>Jx 0.10 cm4 Wx 0.11 cm3</p> <p>Jy 3.99 cm4 Wy 1.53 cm3</p> | | Tavola 23 |
| <p>XX70.601</p> <p>Gocciolatoio</p> <p>Peso kg/ml. 0.269</p> <p>Jx 00.00 cm4 Wx 0.00 cm3</p> <p>Jy 00.00 cm4 Wy 0.00 cm3</p> | | Tavola 21 | <p>RX70.610</p> <p>Profilo per rinforzo montanti</p> <p>Peso kg/ml. 0.994</p> <p>Jx 12.49 cm4 Wx 3.56 cm3</p> <p>Jy 17.78 cm4 Wy 6.84 cm3</p> | | Tavola 23 |
| <p>XX70.602</p> <p>Porta spazzolino</p> <p>Peso kg/ml. 0.372</p> <p>Jx 00.00 cm4 Wx 0.00 cm3</p> <p>Jy 00.00 cm4 Wy 0.00 cm3</p> | | Tavola 21 | <p>XX70.611</p> <p>Profilo per squadretta</p> <p>Peso kg/ml. 3.426</p> <p>Jx 00.00 cm4 Wx 0.00 cm3</p> <p>Jy 00.00 cm4 Wy 0.00 cm3</p> | | Tavola 24 |



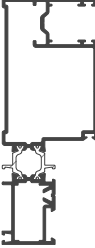
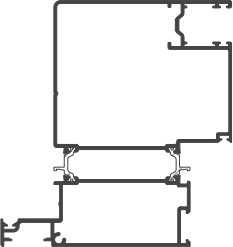
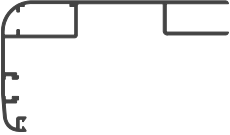

| | | | |
|---------------------------------------------------------------------------------------------------------------------------------------------------------------------------------------------------------------------------------------------------|--------------------------------------------------------------------------------------------------------------|--------------------------------------------------------------------------------------------------------------------------------------------------------------------------------------------------------------------------------------------|------------------------------------------------------------------------------------------------------------|
| <p>XX70.612</p> <p>Profilo bancalino</p> <p>Peso kg/ml. 0.245</p> <p>Jx 00.00 cm⁴ Wx 0.00 cm³</p> <p>Jy 00.00 cm⁴ Wy 0.00 cm³</p> |  <p>Tavola 13</p> | <p>CX60.702</p> <p>Spalla laterale aperta</p> <p>Peso kg/ml. 2.502</p> <p>Jx 185.14 cm⁴ Wx 25.24 cm³</p> <p>Jy 91.91 cm⁴ Wy 11.55 cm³</p> |  <p>Tavola 26</p> |
| <p>XX70.613</p> <p>Profilo angolo universale</p> <p>Peso kg/ml. 1.885</p> <p>Jx 00.00 cm⁴ Wx 0.00 cm³</p> <p>Jy 00.00 cm⁴ Wy 0.00 cm³</p> |  <p>Tavola 24</p> | | |
| <p>XX60.626</p> <p>Profilo per porte va e vieni</p> <p>Peso kg/ml. 0.640</p> <p>Jx 00.00 cm⁴ Wx 0.00 cm³</p> <p>Jy 00.00 cm⁴ Wy 0.00 cm³</p> |  <p>Tavola 31</p> | <p>XX70.703</p> <p>Traverso superiore monoblocco</p> <p>Peso kg/ml. 0.791</p> <p>Jx 00.00 cm⁴ Wx 0.00 cm³</p> <p>Jy 00.00 cm⁴ Wy 0.00 cm³</p> |  <p>Tavola 27</p> |
| <p>XX60.627</p> <p>Battuta riportata per zoccolo</p> <p>Peso kg/ml. 0.637</p> <p>Jx 00.00 cm⁴ Wx 0.00 cm³</p> <p>Jy 00.00 cm⁴ Wy 0.00 cm³</p> |  <p>Tavola 22</p> | <p>XX70.704</p> <p>Coprivite</p> <p>Peso kg/ml. 0.135</p> <p>Jx 00.00 cm⁴ Wx 0.00 cm³</p> <p>Jy 00.00 cm⁴ Wy 0.00 cm³</p> |  <p>Tavola 27</p> |
| <p>XX60.635</p> <p>Battuta riportata per telaio</p> <p>Peso kg/ml. 0.306</p> <p>Jx 00.00 cm⁴ Wx 0.00 cm³</p> <p>Jy 00.00 cm⁴ Wy 0.00 cm³</p> |  <p>Tavola 15 - b</p> | <p>XX70.705</p> <p>Profilo battuta cassonetto</p> <p>Peso kg/ml. 0.155</p> <p>Jx 00.00 cm⁴ Wx 0.00 cm³</p> <p>Jy 00.00 cm⁴ Wy 0.00 cm³</p> |  <p>Tavola 27</p> |
| <p>XX60.637</p> <p>Cartella per profili ELEGANCE</p> <p>Peso kg/ml. 0.219</p> <p>Jx 00.00 cm⁴ Wx 0.00 cm³</p> <p>Jy 00.00 cm⁴ Wy 0.00 cm³</p> |  <p>Tavola 15 - b</p> | <p>CX60.706</p> <p>Mezza spalla monoblocco</p> <p>Peso kg/ml. 2.120</p> <p>Jx 129.80 cm⁴ Wx 19.04 cm³</p> <p>Jy 18.80 cm⁴ Wy 6.56 cm³</p> |  <p>Tavola 27</p> |
| <p>CX60.701</p> <p>Spalla laterale chiusa</p> <p>Peso kg/ml. 3.058</p> <p>Jx 218.07 cm⁴ Wx 30.94 cm³</p> <p>Jy 136.59 cm⁴ Wy 20.42 cm³</p> |  <p>Tavola 26</p> | | |
| <p>XX70.801</p> <p>Imbotte da mm.120</p> <p>Peso kg/ml. 1.317</p> <p>Jx 76.93 cm⁴ Wx 9.91 cm³</p> <p>Jy 20.54 cm⁴ Wy 4.10 cm³</p> |  <p>Tavola 30</p> | | |





Serie **SLIM**

| | | | |
|--------------------------------|------------------------------------------------------|-----------------------------------------------------------------------------------|--------------|
| XX70.802 | |  | Tavola 30 |
| Prolunga da 90 mm. per imbotte | | | |
| Peso | kg/ml. 0.882 | | |
| Jx | 00.00 cm ⁴ Wx 0.00 cm ³ | | |
| Jy | 00.00 cm ⁴ Wy 0.00 cm ³ | | |

| | | | |
|--------------------------------|------------------------------------------------------|-----------------------------------------------------------------------------------|--------------|
| XX70.803 | |  | Tavola 30 |
| Prolunga da 50 mm. per imbotte | | | |
| Peso | kg/ml. 0.574 | | |
| Jx | 00.00 cm ⁴ Wx 0.00 cm ³ | | |
| Jy | 00.00 cm ⁴ Wy 0.00 cm ³ | | |

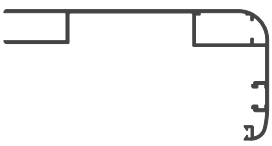
| | | | |
|---------------------------|------------------------------------------------------|-----------------------------------------------------------------------------------|--------------|
| XX70.808 | |  | Tavola 30 |
| Profilo jolly per imbotte | | | |
| Peso | kg/ml. 0.750 | | |
| Jx | 00.00 cm ⁴ Wx 0.00 cm ³ | | |
| Jy | 00.00 cm ⁴ Wy 0.00 cm ³ | | |

| | | | |
|-------------------|--------------------------------------------------------|-------------------------------------------------------------------------------------|--------------|
| XX70.809 | |  | Tavola 30 |
| Imbotte da mm.140 | | | |
| Peso | kg/ml. 1.580 | | |
| Jx | 123.04 cm ⁴ Wx 13.89 cm ³ | | |
| Jy | 22.31 cm ⁴ Wy 4.30 cm ³ | | |

| | | | |
|-----------------------------|------------------------------------------------------|-------------------------------------------------------------------------------------|--------------|
| CX45.3362 | |  | Tavola 28 |
| Profilo centrale cassonetto | | | |
| Peso | kg/ml. 1.150 | | |
| Jx | 00.00 cm ⁴ Wx 0.00 cm ³ | | |
| Jy | 00.00 cm ⁴ Wy 0.00 cm ³ | | |

| | | | |
|-------------------------------|------------------------------------------------------|-------------------------------------------------------------------------------------|--------------|
| CX45.3363 | |  | Tavola 28 |
| Profilo sup./ inf. cassonetto | | | |
| Peso | kg/ml. 1.379 | | |
| Jx | 00.00 cm ⁴ Wx 0.00 cm ³ | | |
| Jy | 00.00 cm ⁴ Wy 0.00 cm ³ | | |

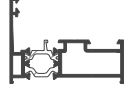
| | | | |
|----------------------|------------------------------------------------------|-------------------------------------------------------------------------------------|--------------|
| CX60S.101 | |  | Tavola 42 |
| Telaio SLIM ad " L " | | | |
| Peso | kg/ml. 0.999 | | |
| Jx | 14.42 cm ⁴ Wx 4.15 cm ³ | | |
| Jy | 03.61 cm ⁴ Wy 1.21 cm ³ | | |

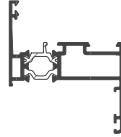
| | | | |
|----------------------|------------------------------------------------------|-------------------------------------------------------------------------------------|--------------|
| CX60S.102 | |  | Tavola 42 |
| Telaio SLIM ad " Z " | | | |
| Peso | kg/ml. 1.131 | | |
| Jx | 19.11 cm ⁴ Wx 6.29 cm ³ | | |
| Jy | 07.20 cm ⁴ Wy 1.97 cm ³ | | |

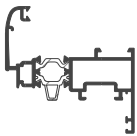
| | | | |
|-------------------|------------------------------------------------------|---------------------------------------------------------------------------------------|--------------|
| CX60S.201 | |  | Tavola 43 |
| Anta piccola SLIM | | | |
| Peso | kg/ml. 1.282 | | |
| Jx | 25.01 cm ⁴ Wx 7.32 cm ³ | | |
| Jy | 08.37 cm ⁴ Wy 2.48 cm ³ | | |

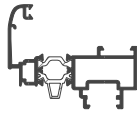
| | | | |
|-----------------------------|------------------------------------------------------|---------------------------------------------------------------------------------------|--------------|
| CX60S.201R | |  | Tavola 43 |
| Anta piccola SLIM s/battuta | | | |
| Peso | kg/ml. 1.236 | | |
| Jx | 21.43 cm ⁴ Wx 5.87 cm ³ | | |
| Jy | 06.71 cm ⁴ Wy 2.09 cm ³ | | |

| | | | |
|-------------------------|------------------------------------------------------|---------------------------------------------------------------------------------------|--------------|
| CX60S.203 | |  | Tavola 43 |
| Anta piccola v.inf.SLIM | | | |
| Peso | kg/ml. 1.433 | | |
| Jx | 27.78 cm ⁴ Wx 7.59 cm ³ | | |
| Jy | 13.53 cm ⁴ Wy 3.56 cm ³ | | |

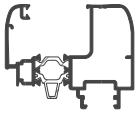
| | | | |
|-----------------------------------|------------------------------------------------------|---------------------------------------------------------------------------------------|--------------|
| CX60S.203R | |  | Tavola 43 |
| Anta piccola v.inf.SLIM s/battuta | | | |
| Peso | kg/ml. 1.388 | | |
| Jx | 24.25 cm ⁴ Wx 7.08 cm ³ | | |
| Jy | 11.39 cm ⁴ Wy 4.10 cm ³ | | |

| | | | |
|-------------------|------------------------------------------------------|---------------------------------------------------------------------------------------|--------------|
| CX60S.304 | |  | Tavola 42 |
| Incontro centrale | | | |
| Peso | kg/ml. 0.427 | | |
| Jx | 00.00 cm ⁴ Wx 0.00 cm ³ | | |
| Jy | 00.00 cm ⁴ Wy 0.00 cm ³ | | |

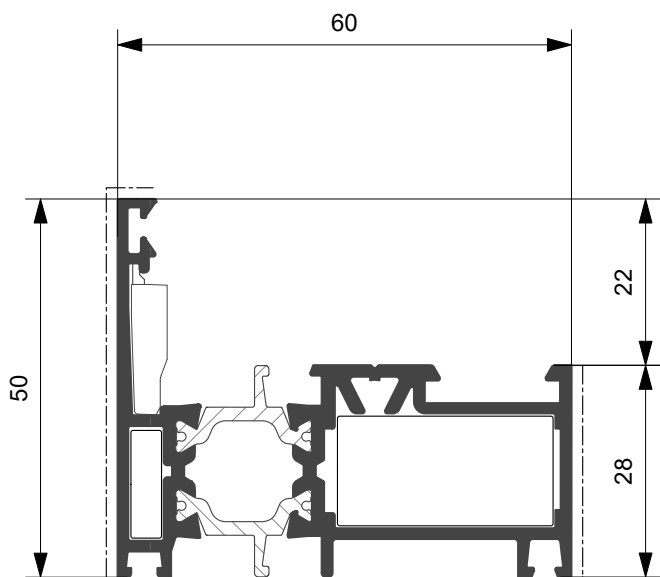

CX60.101

Kg/ml 1.211
--- mm. 78,0

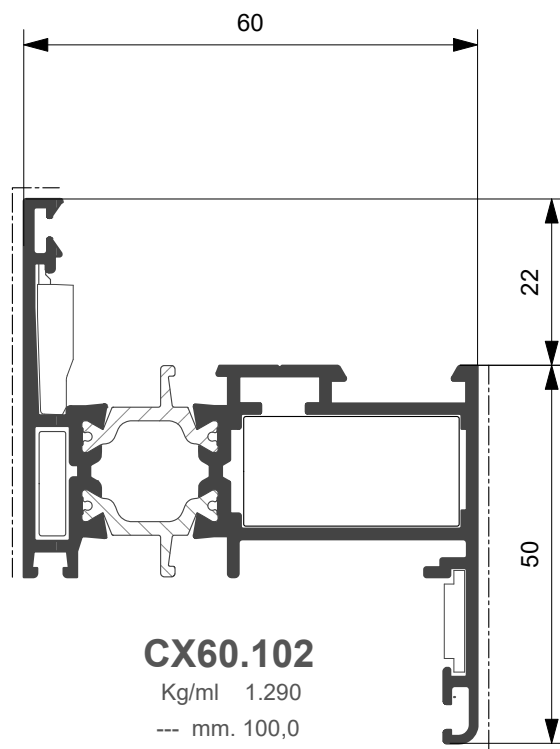

CX60.102

Kg/ml 1.290
--- mm. 100,0

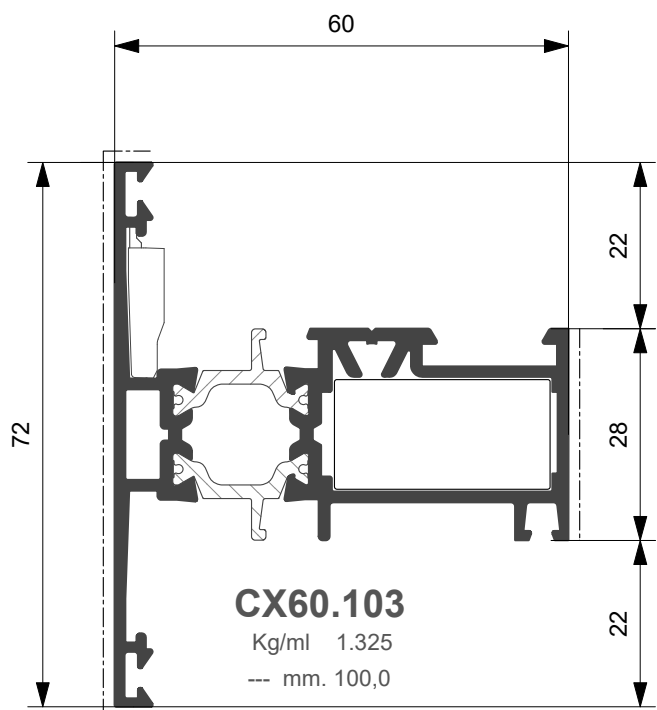

CX60.103

Kg/ml 1.325
--- mm. 100,0

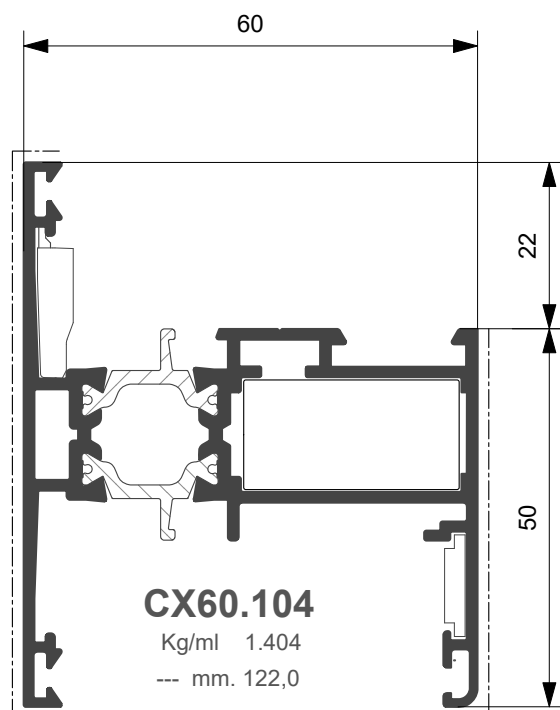

CX60.104

Kg/ml 1.404
--- mm. 122,0

| Profilato | Squadretta esterna | | Squadretta interna | | | Squadretta allineamento | |
|-----------|--------------------|-----------------------|--------------------|-------------|-----------------------|-------------------------|-----------|
| | Cianfrinare | Spinare | Bottone | Cianfrinare | Spinare | Esterna | Interna |
| CX60.101 | ARX.03.SQ | ARX.03.SQ + ARX.08.SQ | ACX.01.SQ | ACX.02.SQ | ACX.02.SQ + ARX.07.SQ | ARX.15.SQ | |
| CX60.102 | ARX.03.SQ | ARX.03.SQ + ARX.08.SQ | ACX.01.SQ | ACX.02.SQ | ACX.02.SQ + ARX.07.SQ | ARX.15.SQ | ARX.10.SQ |
| CX60.103 | | | ACX.01.SQ | ACX.02.SQ | ACX.02.SQ + ARX.07.SQ | ARX.15.SQ | |
| CX60.104 | | | ACX.01.SQ | ACX.02.SQ | ACX.02.SQ + ARX.07.SQ | ARX.15.SQ | ARX.10.SQ |

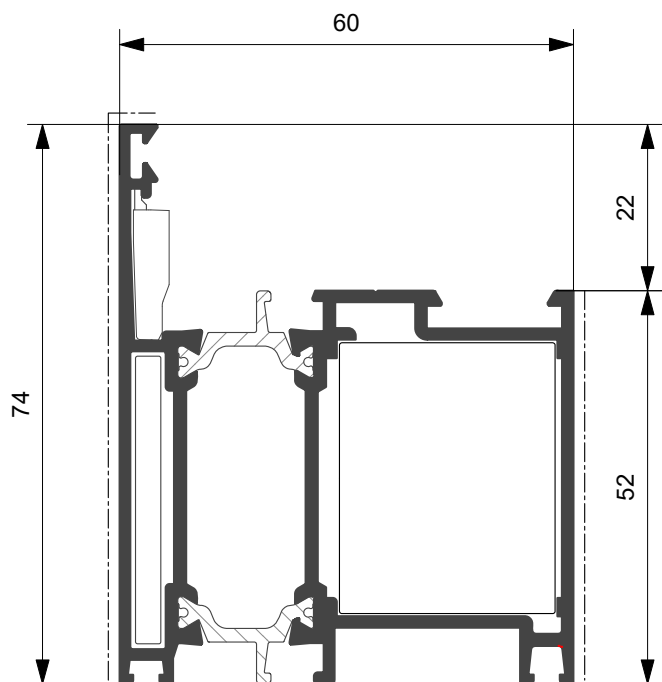

CX60.105

Kg/ml 1.605
--- mm. 126,0

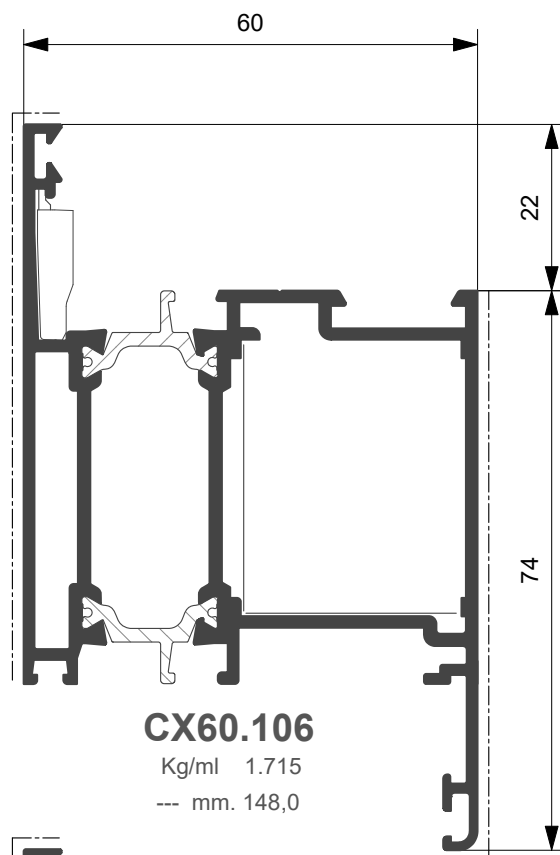

CX60.106

Kg/ml 1.715
--- mm. 148,0

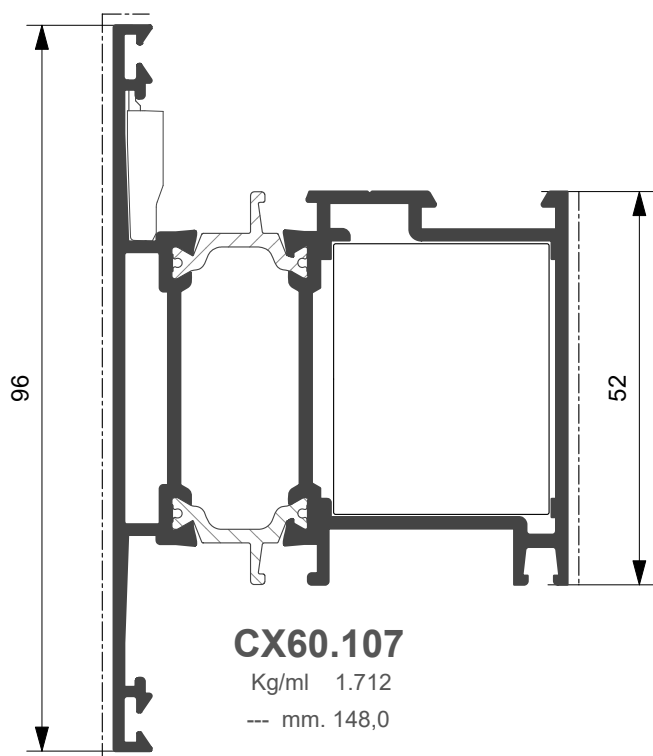

CX60.107

Kg/ml 1.712
--- mm. 148,0

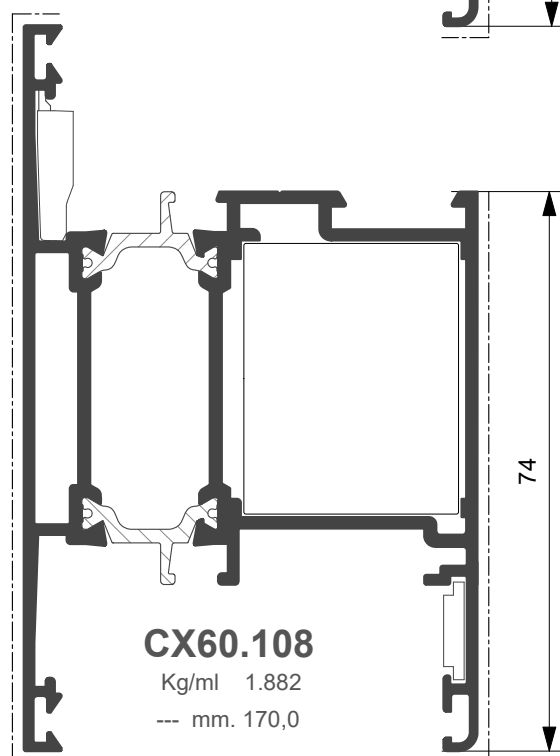

CX60.108

Kg/ml 1.882
--- mm. 170,0

| Profilato | Squadretta esterna | | Squadretta interna | | | Squadretta allineamento | |
|-----------|--------------------|-----------------------|--------------------|-------------|--------------------|-------------------------|-----------|
| | Cianfrinare | Spinare | Bottone | Cianfrinare | Spinare o Avvitare | Esterna | Interna |
| CX60.105 | ARX.06.SQ | ARX.06.SQ + ARX.08.SQ | ACX.04.SQ | ACX.14.SQ | ACX.14.SQ | ARX.15.SQ | |
| CX60.106 | ARX.06.SQ | ARX.06.SQ + ARX.08.SQ | ACX.04.SQ | ACX.14.SQ | ACX.14.SQ | ARX.15.SQ | ARX.10.SQ |
| CX60.107 | | | ACX.04.SQ | ACX.14.SQ | ACX.14.SQ | ARX.15.SQ | |
| CX60.108 | | | ACX.04.SQ | ACX.14.SQ | ACX.14.SQ | ARX.15.SQ | ARX.10.SQ |

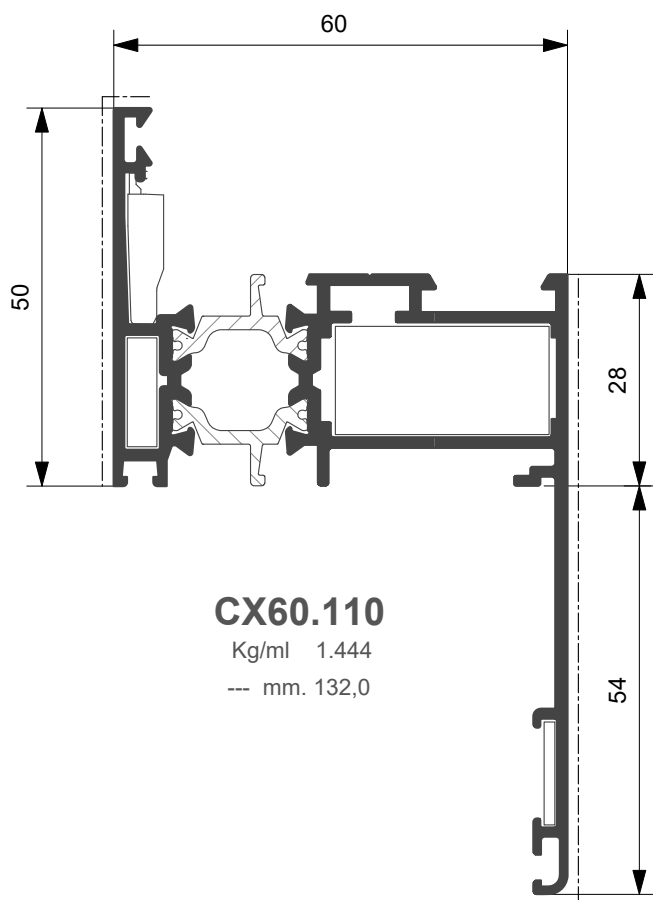

CX60.110

Kg/ml 1.444

--- mm. 132,0

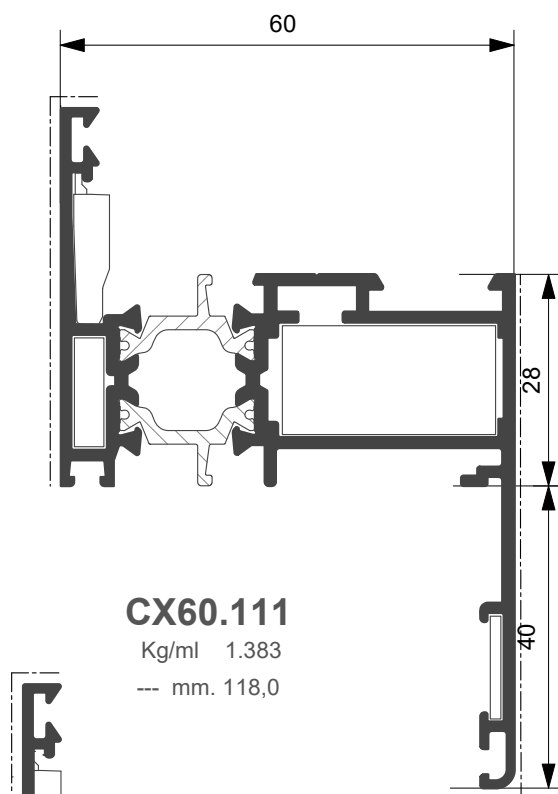

CX60.111

Kg/ml 1.383

--- mm. 118,0

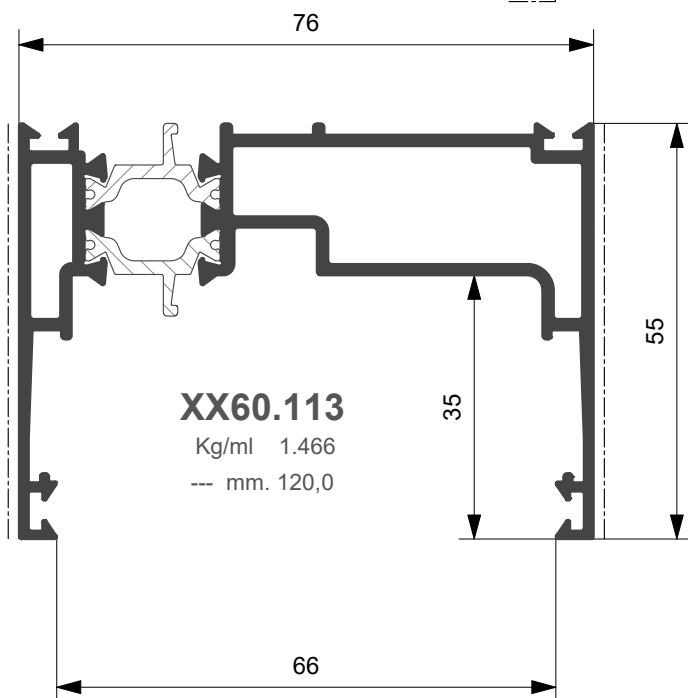

XX60.113

Kg/ml 1.466

--- mm. 120,0

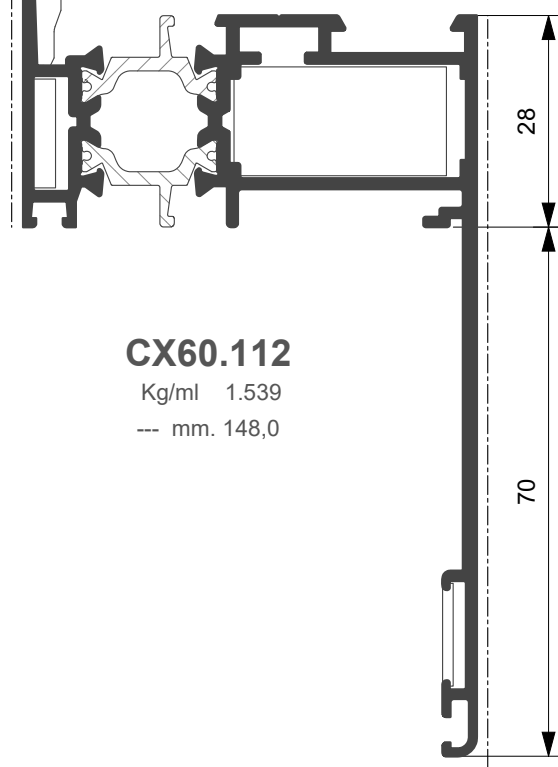

CX60.112

Kg/ml 1.539

--- mm. 148,0

| Profilato | Squadretta esterna | | Squadretta interna | | | Squadretta allineamento | |
|-----------|--------------------|-----------------------|--------------------|-------------|-----------------------|-------------------------|-----------|
| | Cianfrinare | Spinare | Bottone | Cianfrinare | Spinare | Esterna | Interna |
| CX60.110 | ARX.03.SQ | ARX.03.SQ + ARX.08.SQ | ACX.01.SQ | ACX.02.SQ | ACX.02.SQ + ARX.07.SQ | ARX.15.SQ | ARX.10.SQ |
| CX60.111 | ARX.03.SQ | ARX.03.SQ + ARX.08.SQ | ACX.01.SQ | ACX.02.SQ | ACX.02.SQ + ARX.07.SQ | ARX.15.SQ | ARX.10.SQ |
| CX60.112 | ARX.03.SQ | ARX.03.SQ + ARX.08.SQ | ACX.01.SQ | ACX.02.SQ | ACX.02.SQ + ARX.07.SQ | ARX.15.SQ | ARX.10.SQ |

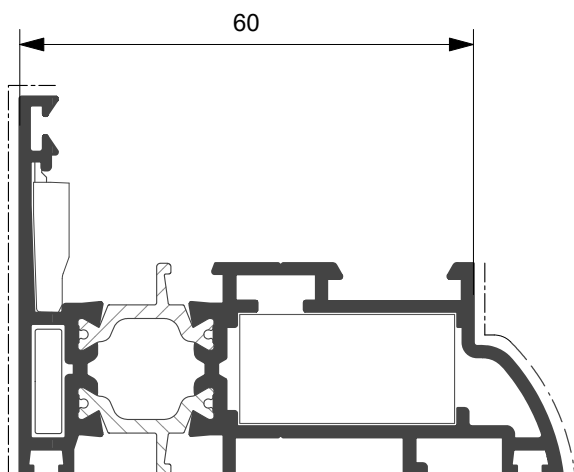

CX60.155

Kg/ml 1.268

--- mm. 88,0

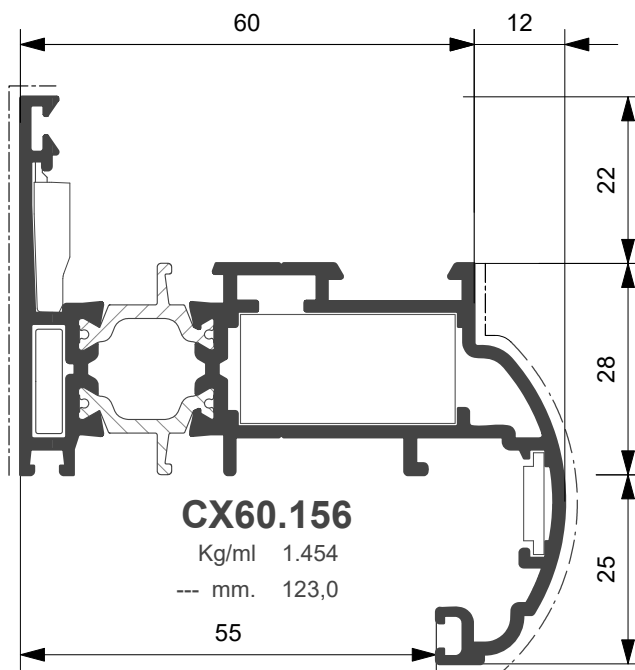

CX60.156

Kg/ml 1.454

--- mm. 123,0

55

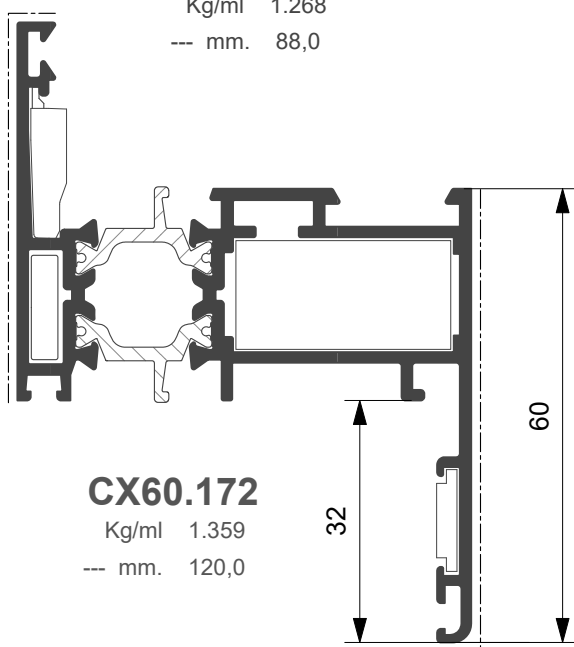

CX60.172

Kg/ml 1.359

--- mm. 120,0

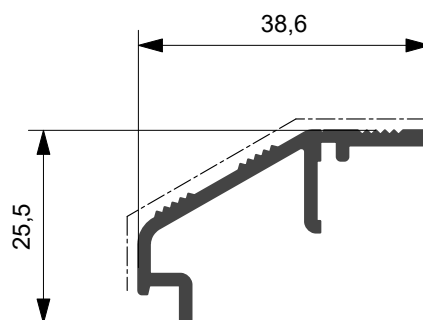

XX70.606

Kg/ml 0.322

--- mm. 50,0

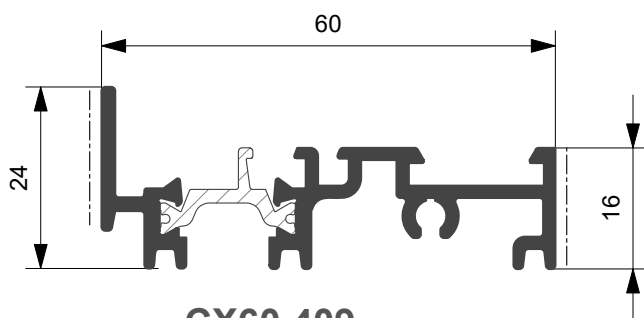

CX60.409

Kg/ml 0.785

--- mm. 34,0

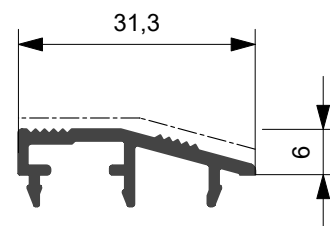

XX70.607

Kg/ml 0.224

--- mm. 32,0

| Profilato | Squadretta esterna | | Squadretta interna | | | Squadretta allineamento | |
|-----------|--------------------|-----------------------|--------------------|-------------|-----------------------|-------------------------|-----------|
| | Cianfrinare | Spinare | Bottone | Cianfrinare | Spinare | Esterna | Interna |
| CX60.155 | ARX.03.SQ | ARX.03.SQ + ARX.08.SQ | ACX.01.SQ | ACX.02.SQ | ACX.02.SQ + ARX.07.SQ | ARX.15.SQ | |
| CX60.156 | ARX.03.SQ | ARX.03.SQ + ARX.08.SQ | ACX.01.SQ | ACX.02.SQ | ACX.02.SQ + ARX.07.SQ | ARX.15.SQ | ARX.10.SQ |
| CX60.172 | ARX.03.SQ | ARX.03.SQ + ARX.08.SQ | ACX.01.SQ | ACX.02.SQ | ACX.02.SQ + ARX.07.SQ | ARX.15.SQ | ARX.10.SQ |
| | | | | | | | |

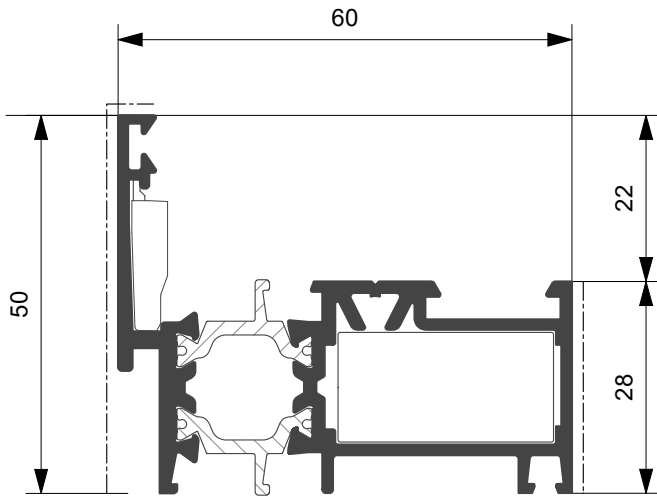

CX60.124

Kg/ml 1.182
--- mm. 78,0

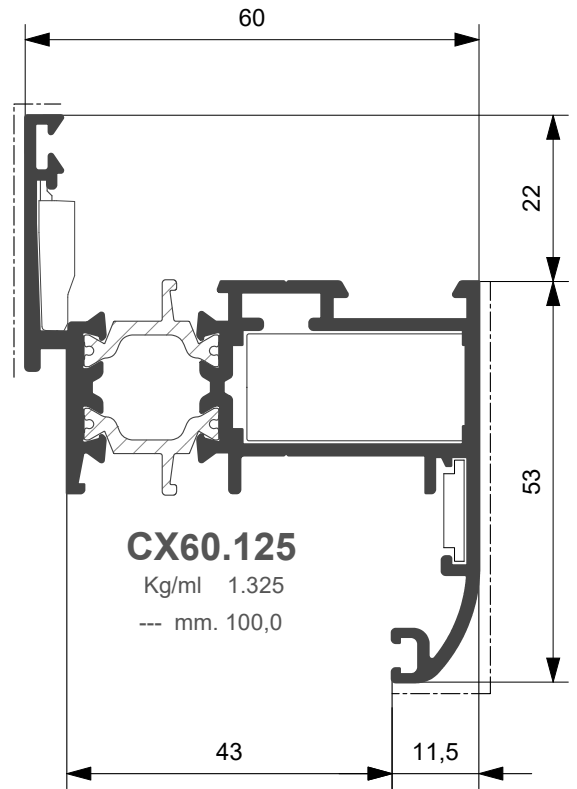

CX60.125

Kg/ml 1.325
--- mm. 100,0

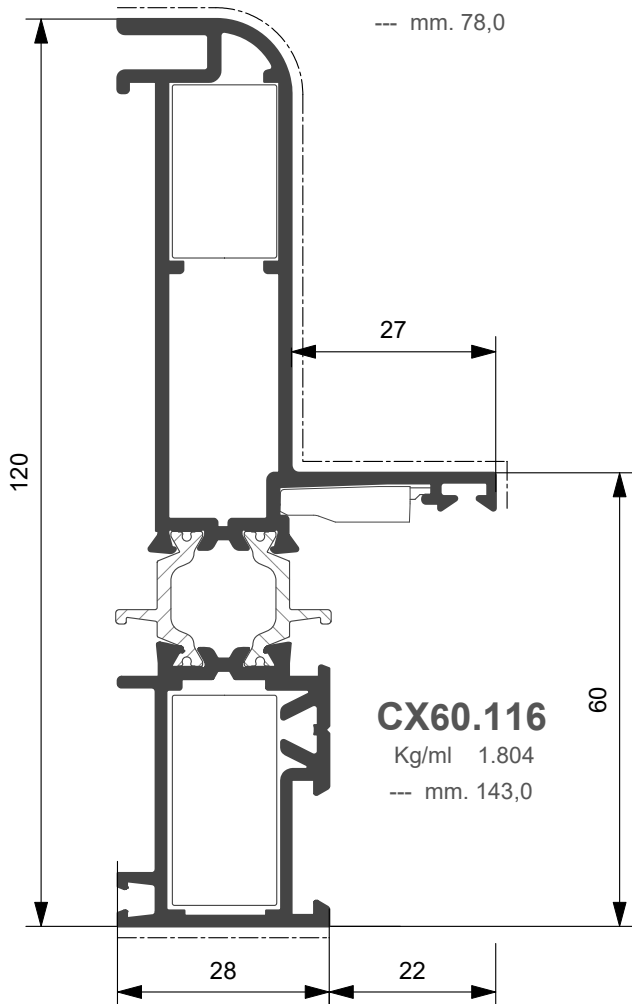

CX60.116

Kg/ml 1.804
--- mm. 143,0

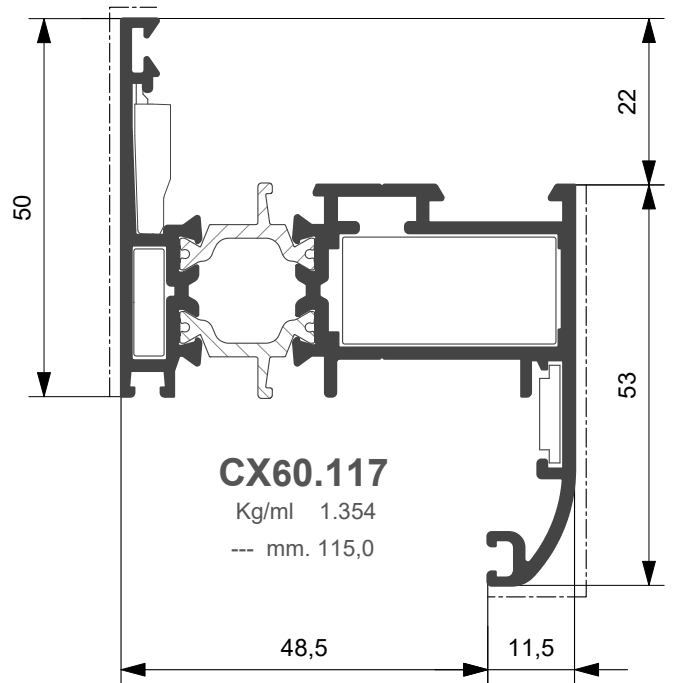

CX60.117

Kg/ml 1.354
--- mm. 115,0

| Profilato | Squadretta esterna | | Squadretta interna | | | Squadretta allineamento | |
|-----------|---------------------|-----------------------|--------------------|-------------|-----------------------|-------------------------|-----------|
| | Cianfrinare | Spinare | Bottone | Cianfrinare | Spinare | Esterna | Interna |
| CX60.116 | ARX.13.SQ a bottone | | ACX.01.SQ | | | ARX.15.SQ | |
| CX60.117 | ARX.03.SQ | ARX.03.SQ + ARX.08.SQ | ACX.01.SQ | ACX.02.SQ | ACX.02.SQ + ARX.07.SQ | ARX.15.SQ | ARX.10.SQ |
| CX60.124 | | | ACX.01.SQ | ACX.02.SQ | ACX.02.SQ + ARX.07.SQ | ARX.15.SQ | |
| CX60.125 | | | ACX.01.SQ | ACX.02.SQ | ACX.02.SQ + ARX.07.SQ | ARX.15.SQ | ARX.10.SQ |

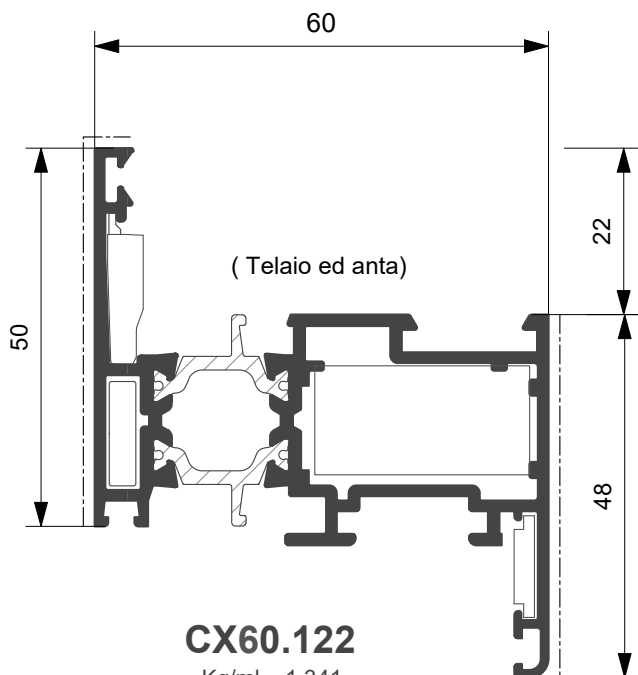

CX60.122

Kg/ml 1.341
--- mm. 98

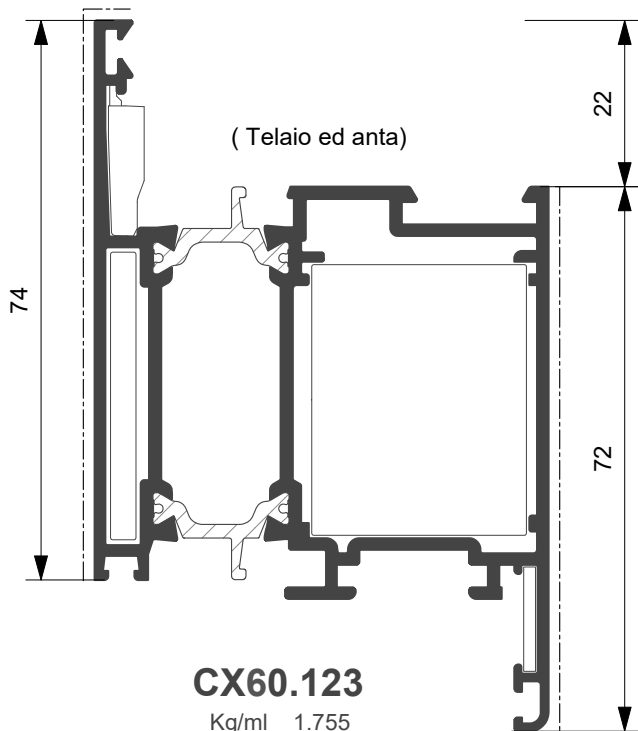

CX60.123

Kg/ml 1.755
--- mm. 146

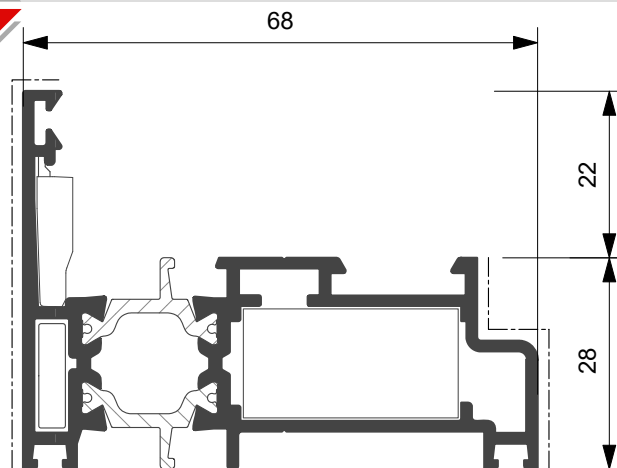

CX60.119

Kg/ml 1.243
--- mm. 86,0

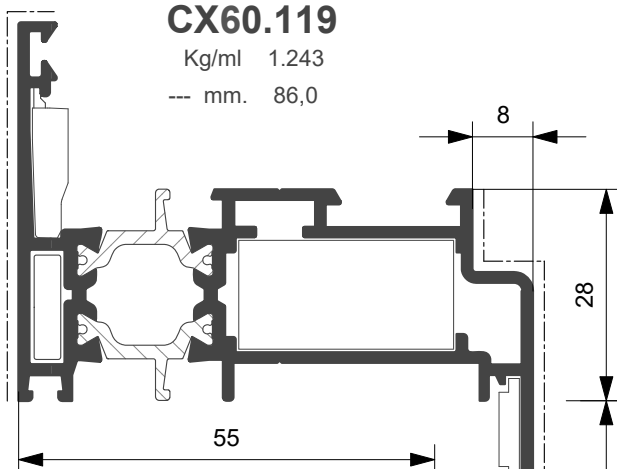

CX60.120

Kg/ml 1.417
--- mm. 111,0

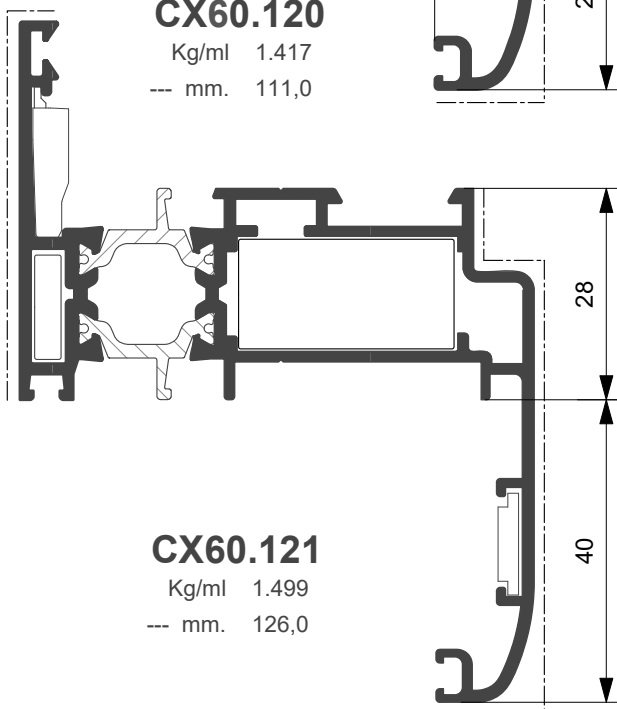

CX60.121

Kg/ml 1.499
--- mm. 126,0

| Profilato | Squadretta esterna | | Squadretta interna | | | Squadretta allineamento | |
|-----------|--------------------|-----------------------|--------------------|-------------|-----------------------|-------------------------|-----------|
| | Cianfrinare | Spinare | Bottone | Cianfrinare | Spinare | Esterna | Interna |
| CX60.119 | ARX.03.SQ | ARX.03.SQ + ARX.08.SQ | ACX.01.SQ | ACX.02.SQ | ACX.02.SQ + ARX.07.SQ | ARX.15.SQ | |
| CX60.120 | ARX.03.SQ | ARX.03.SQ + ARX.08.SQ | ACX.01.SQ | ACX.02.SQ | ACX.02.SQ + ARX.07.SQ | ARX.15.SQ | ARX.10.SQ |
| CX60.121 | ARX.03.SQ | ARX.03.SQ + ARX.08.SQ | ACX.01.SQ | ACX.02.SQ | ACX.02.SQ + ARX.07.SQ | ARX.15.SQ | ARX.10.SQ |
| CX60.122 | ARX.03.SQ | ARX.03.SQ + ARX.08.SQ | ACX.01.SQ | ACX.02.SQ | ACX.02.SQ + ARX.07.SQ | ARX.15.SQ | ARX.10.SQ |
| CX60.123 | ARX.06.SQ | ARX.06.SQ + ARX.08.SQ | ACX.04.SQ | ACX.14.SQ | ACX.14.SQ | ARX.15.SQ | ARX.10.SQ |

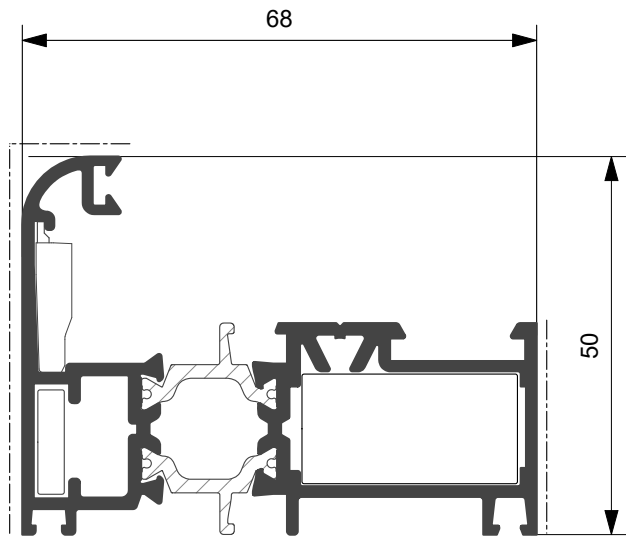

CX60.152

Kg/ml 1.357
--- mm. 86,0

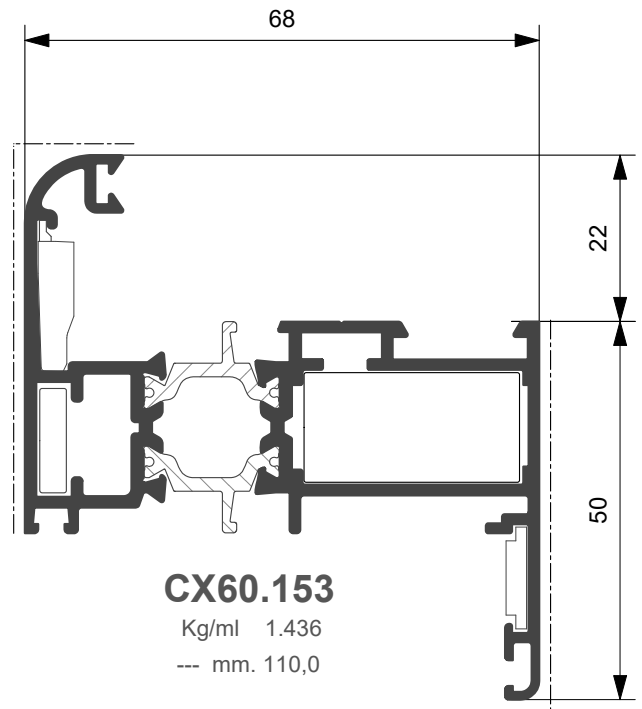

CX60.153

Kg/ml 1.436
--- mm. 110,0

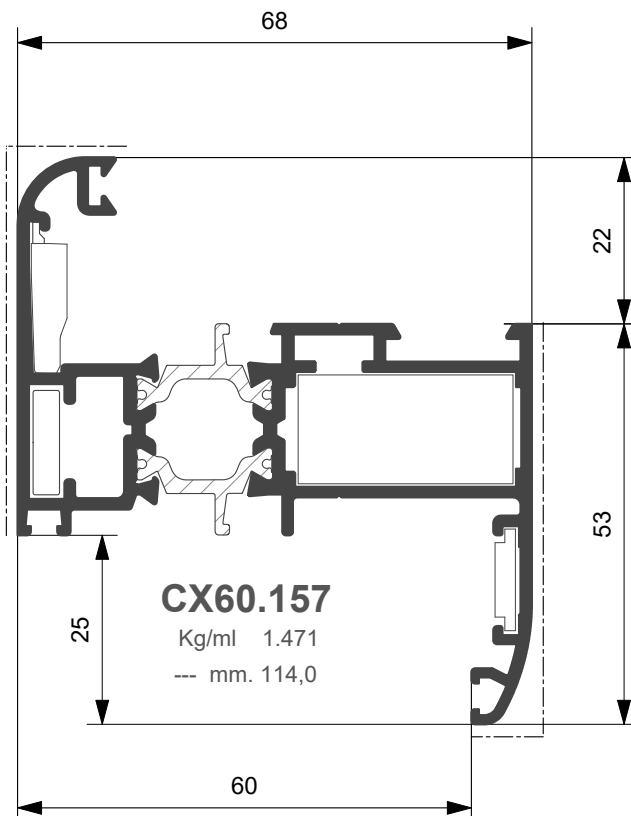

CX60.157

Kg/ml 1.471
--- mm. 114,0

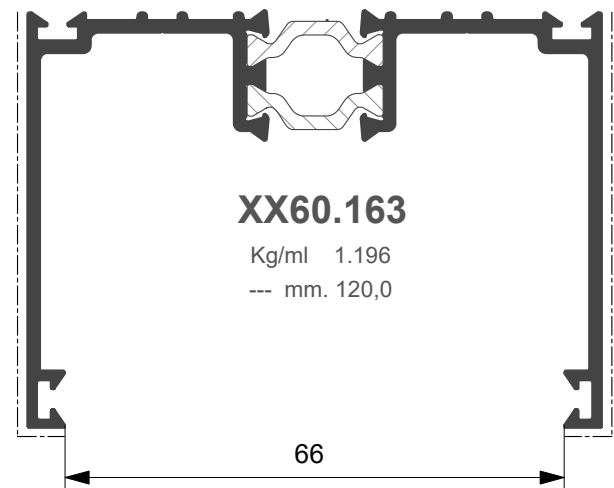

XX60.163

Kg/ml 1.196
--- mm. 120,0

| Profilato | Squadretta esterna | | Squadretta interna | | | Squadretta allineamento | |
|-----------|--------------------|-----------------------|--------------------|-------------|-----------------------|-------------------------|-----------|
| | Cianfrinare | Spinare | Bottone | Cianfrinare | Spinare | Esterna | Interna |
| CX60.152 | ARX.03.SQ | ARX.03.SQ + ARX.08.SQ | ACX.01.SQ | ARX.02.SQ | ACX.02.SQ + ARX.07.SQ | ARX.15.SQ | |
| CX60.153 | ARX.03.SQ | ARX.03.SQ + ARX.08.SQ | ACX.01.SQ | ARX.02.SQ | ACX.02.SQ + ARX.07.SQ | ARX.15.SQ | ARX.10.SQ |
| CX60.157 | ARX.03.SQ | ARX.03.SQ + ARX.08.SQ | ACX.01.SQ | ARX.02.SQ | ACX.02.SQ + ARX.07.SQ | ARX.15.SQ | ARX.10.SQ |

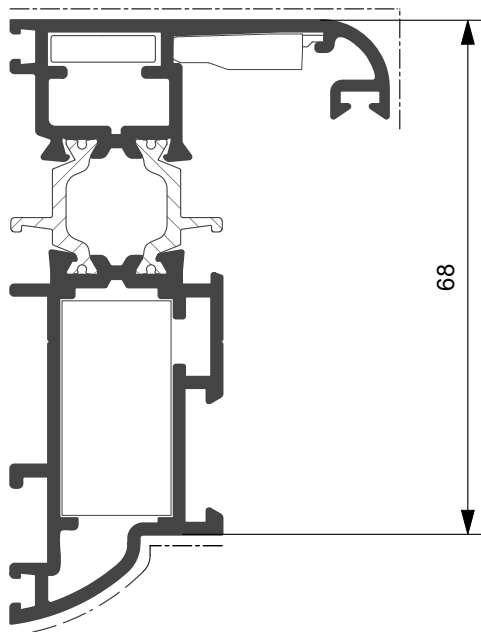

CX60.161

Kg/ml 1.414
--- mm. 96,0

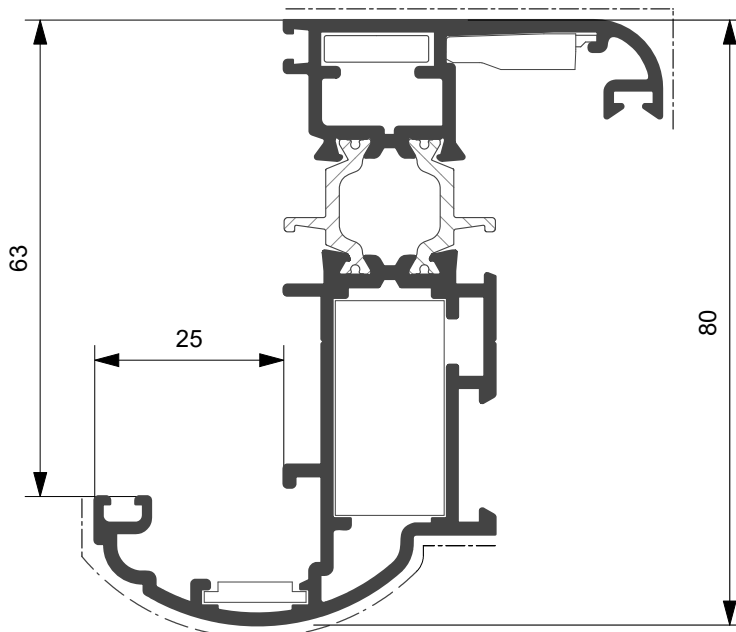

CX60.162

Kg/ml 1.600
--- mm. 131,0

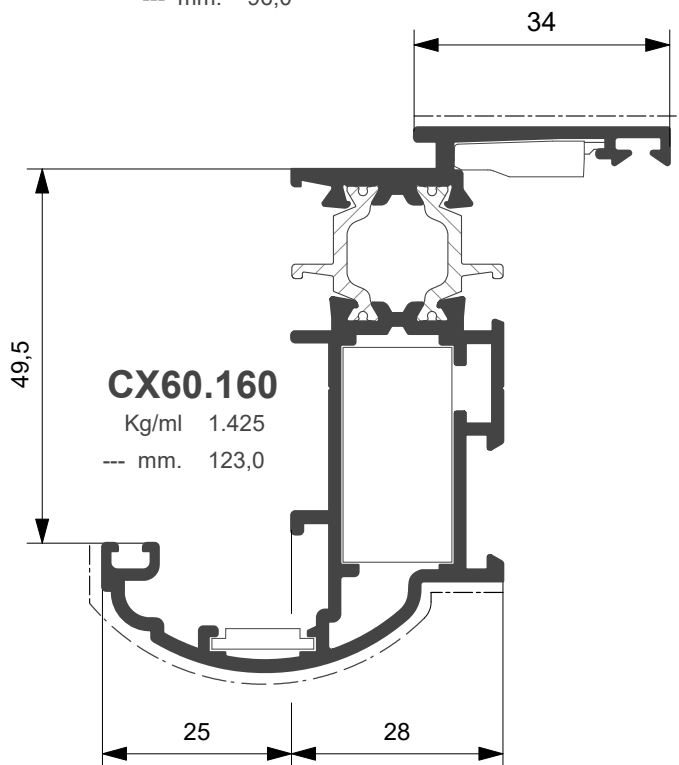

CX60.160

Kg/ml 1.425
--- mm. 123,0

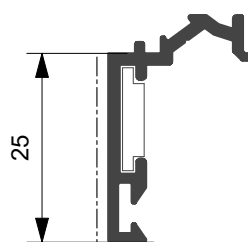

XX70.612

Kg/ml 0.245
--- mm. 25,0



XX60.635

Kg/ml 0.306
--- mm. 41,0

| Profilato | Squadretta esterna | | Squadretta interna | | | Squadretta allineamento | |
|-----------|--------------------|-----------------------|--------------------|-------------|-----------------------|-------------------------|-----------|
| | Cianfrinare | Spinare | Bottone | Cianfrinare | Spinare | Esterna | Interna |
| CX60.160 | | | ACX.01.SQ | ARX.02.SQ | ACX.02.SQ + ARX.07.SQ | ARX.15.SQ | ARX.10.SQ |
| CX60.161 | ARX.03.SQ | ARX.03.SQ + ARX.08.SQ | ACX.01.SQ | ARX.02.SQ | ACX.02.SQ + ARX.07.SQ | ARX.15.SQ | ARX.10.SQ |
| CX60.162 | ARX.03.SQ | ARX.03.SQ + ARX.08.SQ | ACX.01.SQ | ARX.02.SQ | ACX.02.SQ + ARX.07.SQ | ARX.15.SQ | |

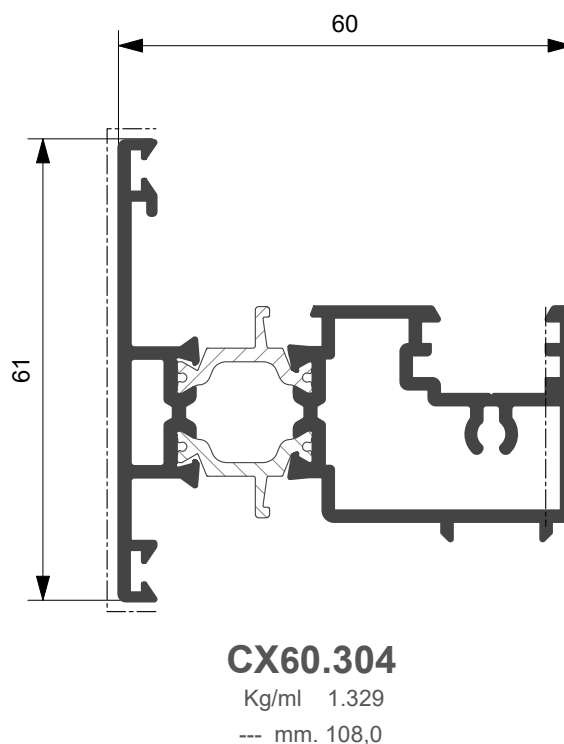
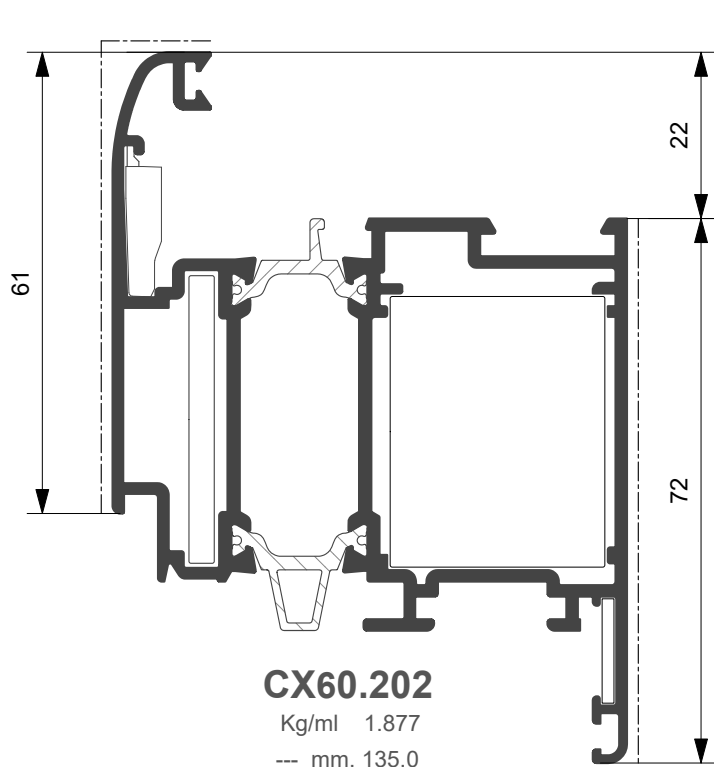
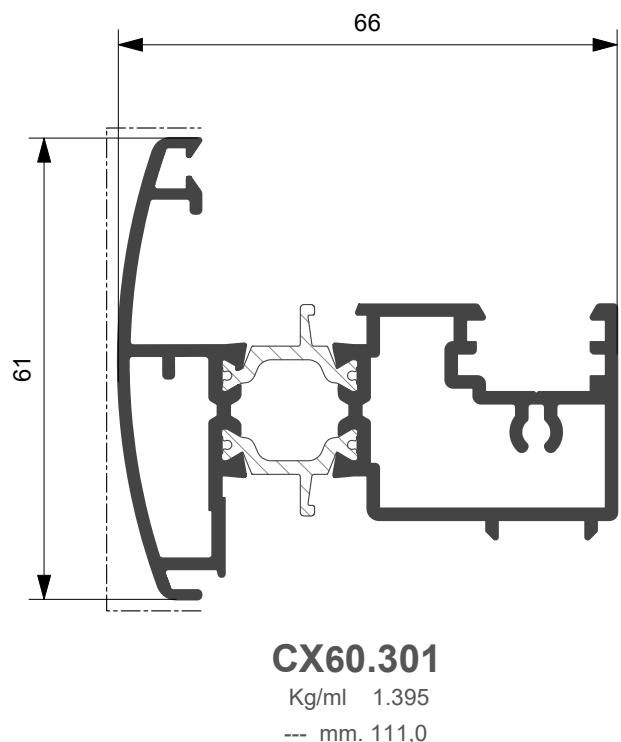
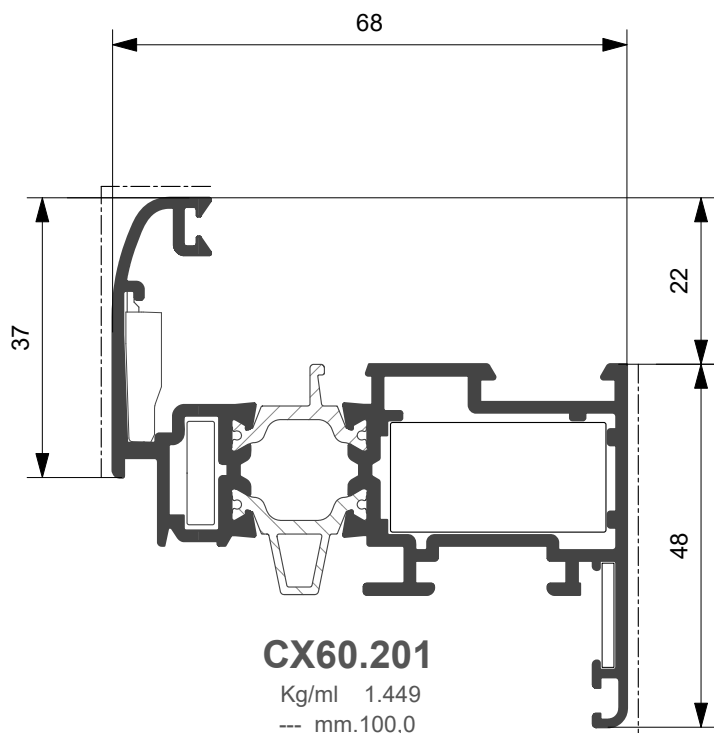

| Profilato | Squadretta esterna | | Squadretta interna | | | Squadretta allineamento | |
|-----------|--------------------|-----------------------|--------------------|-------------|-----------------------|-------------------------|-----------|
| | Cianfrinare | Spinare | Bottone | Cianfrinare | Spinare o Avvitare | Esterna | Interna |
| CX60.201 | ARX.03.SQ | ARX.03.SQ + ARX.08.SQ | ACX.01.SQ | ACX.02.SQ | ACX.02.SQ + ARX.07.SQ | ARX.15.SQ | ARX.10.SQ |
| CX60.202 | ARX.06.SQ | ARX.06.SQ + ARX.08.SQ | ACX.04.SQ | ACX.14.SQ | ACX.14.SQ | ARX.15.SQ | ARX.10.SQ |
| | | | | | | | |

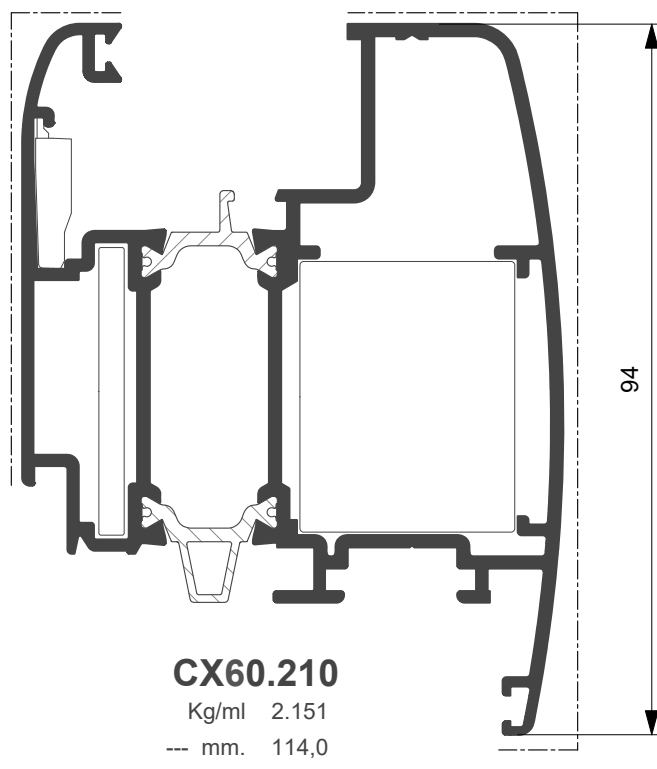
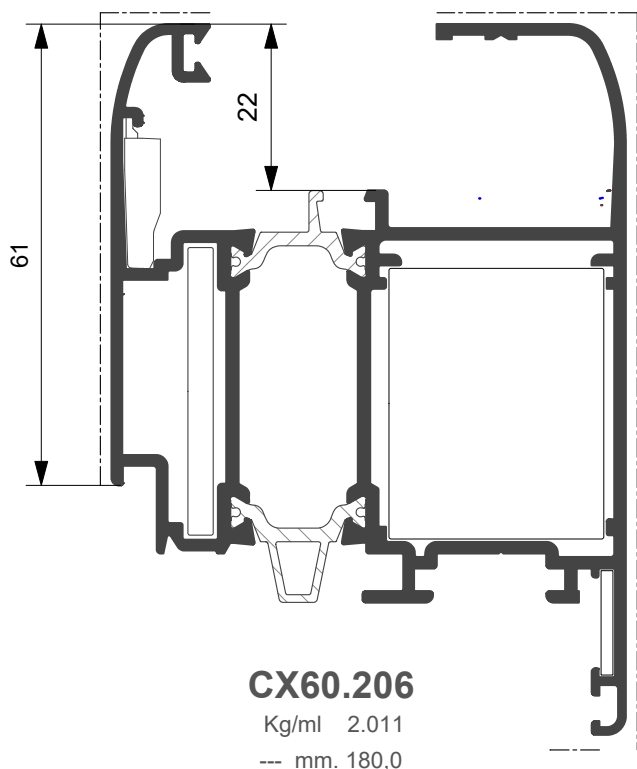
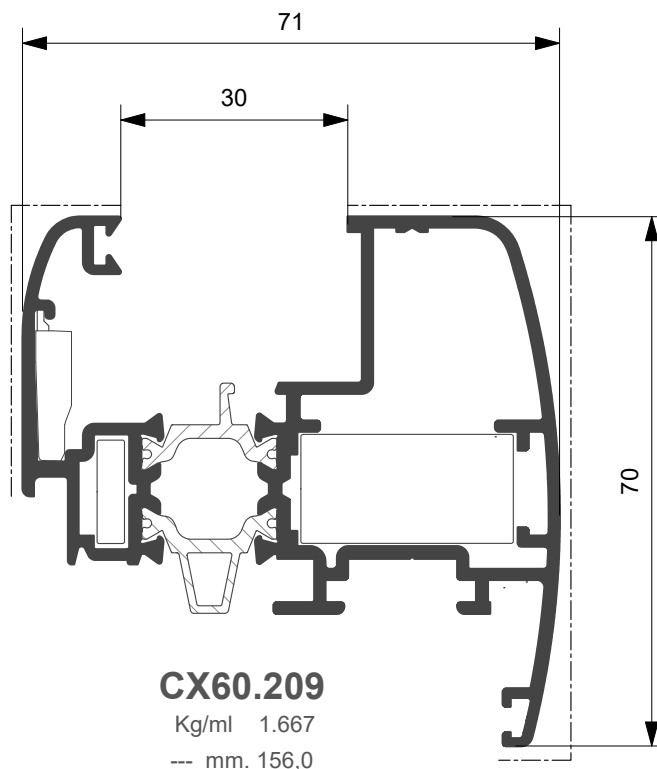
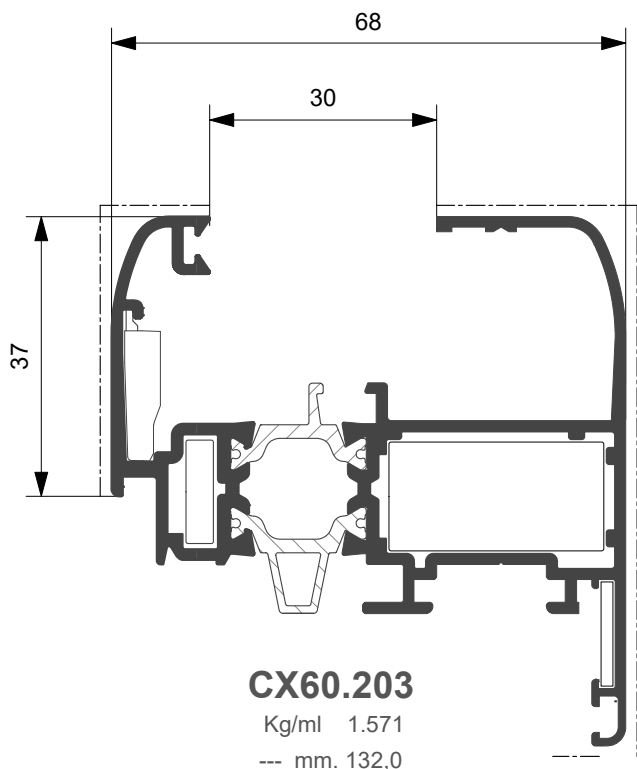

| Profilato | Squadretta esterna | | Squadretta interna | | | Squadretta allineamento | |
|-----------|--------------------|-----------------------|--------------------|-------------|-----------------------|-------------------------|-----------|
| | Cianfrinare | Spinare | Bottone | Cianfrinare | Spinare o Avvitare | Esterna | Interna |
| CX60.203 | | ARX.03.SQ + ARX.08.SQ | ACX.01.SQ | | ACX.02.SQ + ARX.07.SQ | ARX.15.SQ | ARX.10.SQ |
| CX60.206 | | ARX.06.SQ + ARX.08.SQ | ACX.04.SQ | | ACX.14.SQ | ARX.15.SQ | ARX.10.SQ |
| CX60.209 | | ARX.03.SQ + ARX.08.SQ | ACX.01.SQ | | ACX.02.SQ + ARX.07.SQ | ARX.15.SQ | |
| CX60.210 | | ARX.06.SQ + ARX.08.SQ | ACX.04.SQ | | ACX.14.SQ | ARX.15.SQ | |

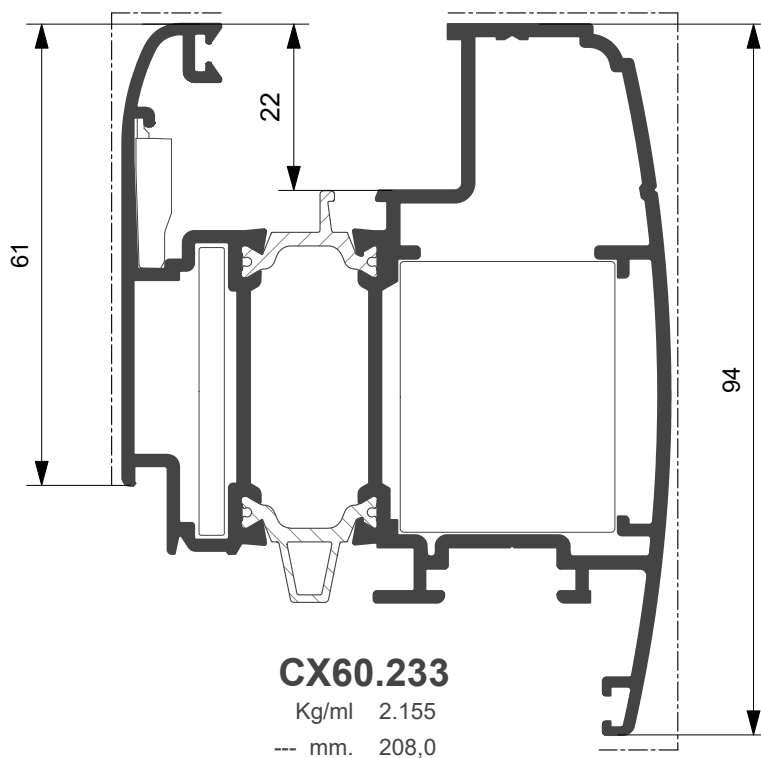
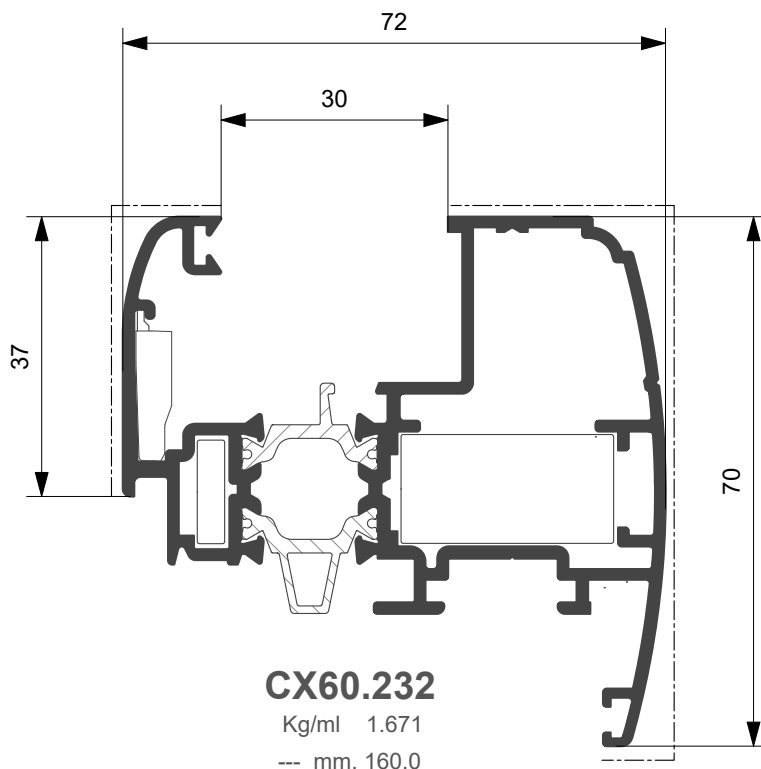

| Profilato | Squadretta esterna | | Squadretta interna | | | Squadretta allineamento | |
|-----------|--------------------|-----------------------|--------------------|-------------|-----------------------|-------------------------|-----------|
| | Cianfrinare | Spinare | Bottone | Cianfrinare | Spinare o Avvitare | Esterna | Interna |
| CX60.232 | ARX.03.SQ | ARX.03.SQ + ARX.08.SQ | ACX.01.SQ | | ACX.02.SQ + ARX.07.SQ | ARX.15.SQ | ARX.10.SQ |
| CX60.233 | ARX.06.SQ | ARX.06.SQ + ARX.08.SQ | ACX.04.SQ | | ACX.14.SQ | ARX.15.SQ | ARX.10.SQ |
| | | | | | | | |
| | | | | | | | |

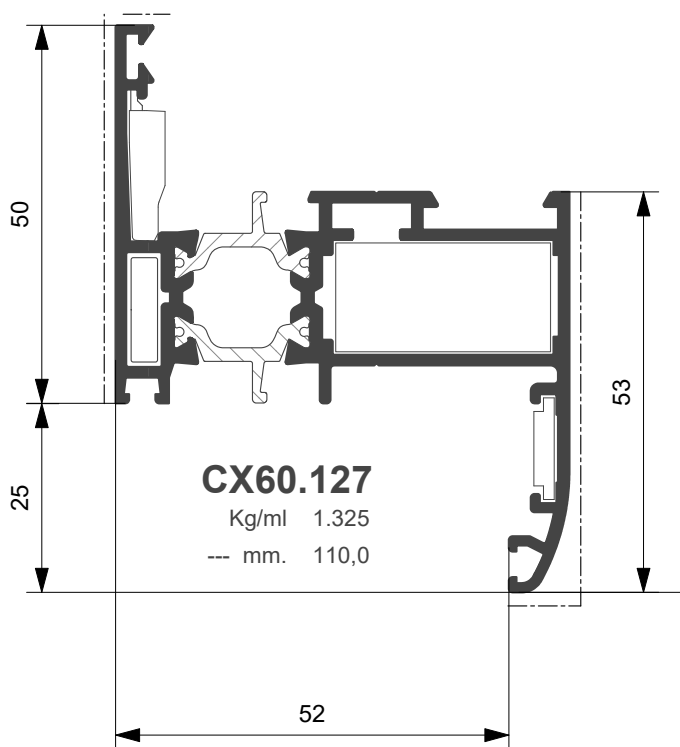
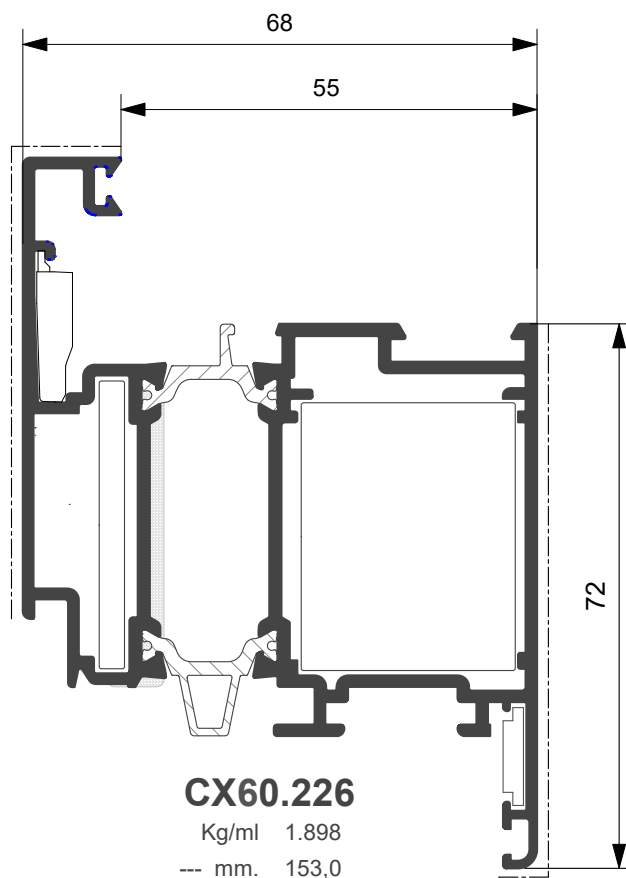
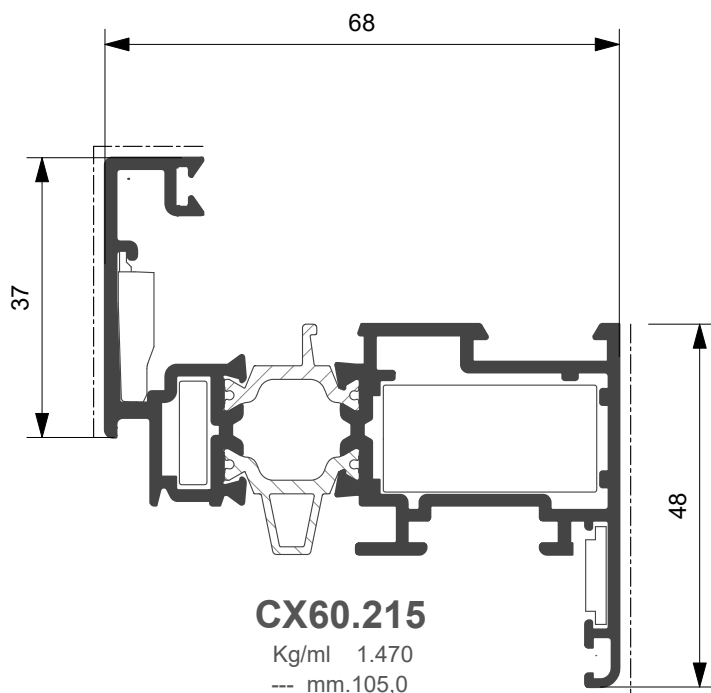

| Profilato | Squadretta esterna | | Squadretta interna | | | Squadretta allineamento | |
|-----------|--------------------|-----------------------|--------------------|-------------|-----------------------|-------------------------|-----------|
| | Cianfrinare | Spinare o Avvitare | Bottone | Cianfrinare | Spinare | Esterna | Interna |
| CX60.127 | ARX.03.SQ | ARX.03.SQ + ARX.08.SQ | ACX.01.SQ | | ACX.02.SQ + ARX.07.SQ | ARX.15.SQ | ARX.10.SQ |
| CX60.215 | ARX.03.SQ | ARX.03.SQ + ARX.08.SQ | ACX.01.SQ | | ACX.02.SQ + ARX.07.SQ | ARX.15.SQ | ARX.10.SQ |
| CX60.226 | ARX.06.SQ | ARX.06.SQ + ARX.08.SQ | ACX.04.SQ | ACX.14.SQ | ACX.14.SQ | ARX.15.SQ | ARX.10.SQ |

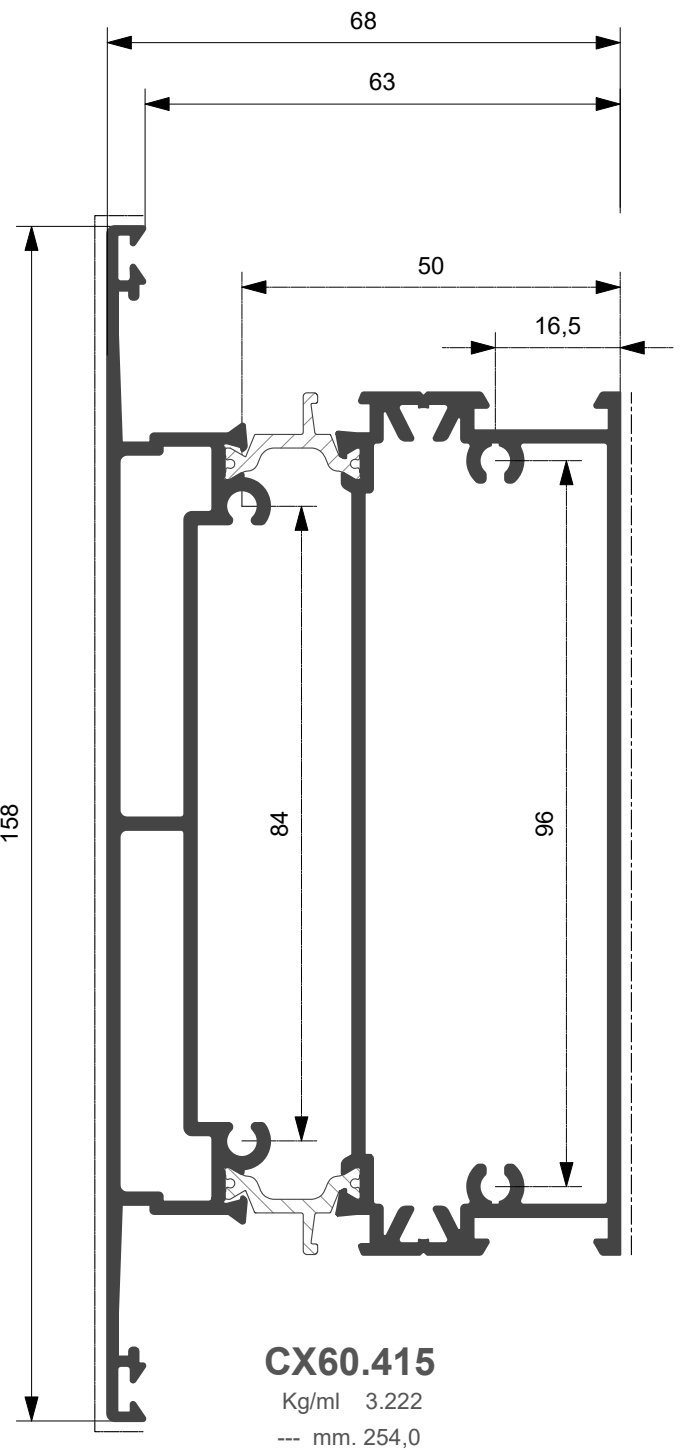
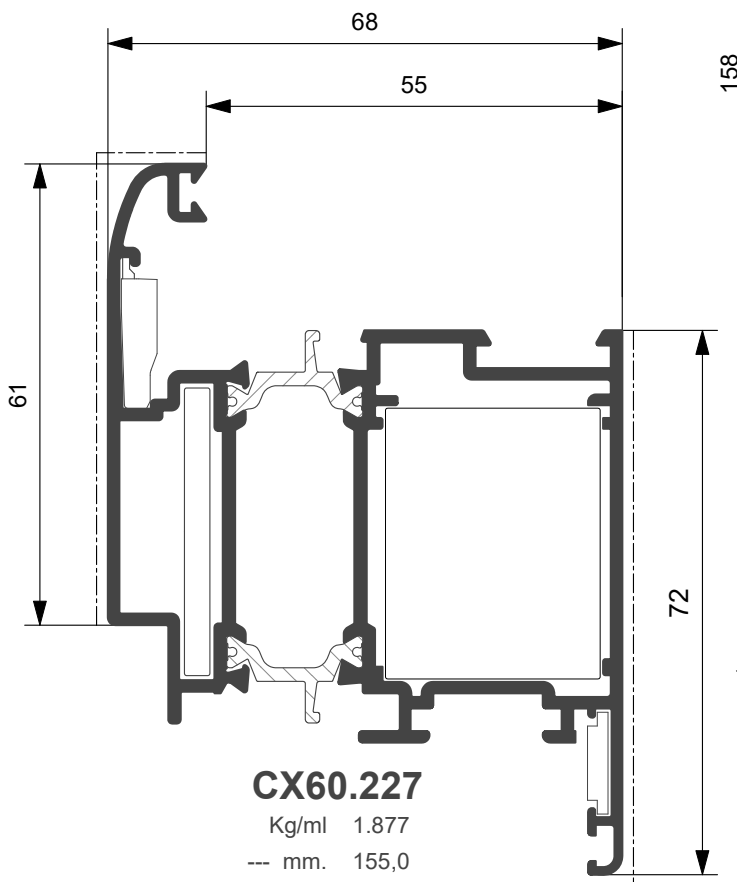
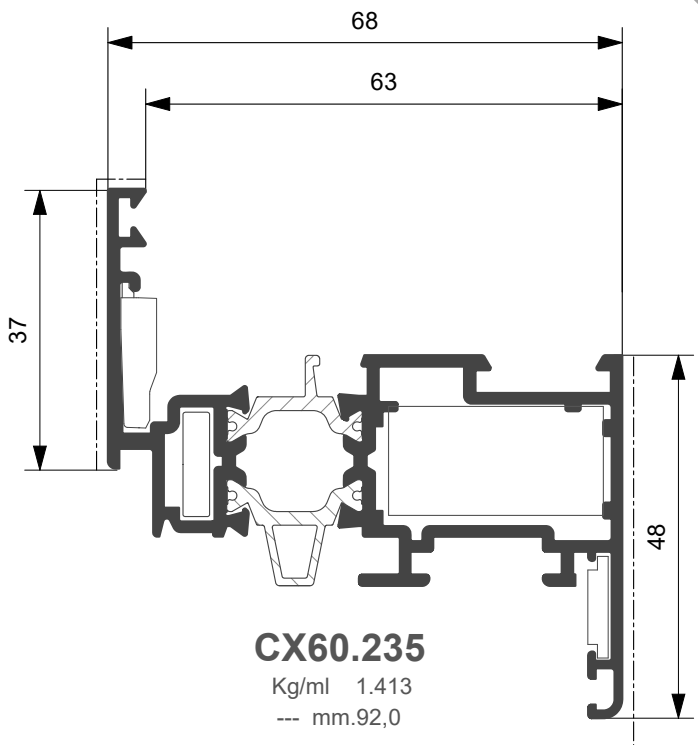

| Profilato | Squadretta esterna | | Squadretta interna | | | Squadretta allineamento | |
|-----------|--------------------|-----------------------|--------------------|-------------|-----------------------|-------------------------|-----------|
| | Cianfrinare | Spinare o Avvitare | Bottone | Cianfrinare | Spinare | Esterna | Interna |
| CX60.227 | ARX.06.SQ | ARX.06.SQ + ARX.08.SQ | ACX.04.SQ | ACX.14.SQ | ACX.14.SQ | ARX.15.SQ | ARX.10.SQ |
| CX60.235 | ARX.03.SQ | ARX.03.SQ + ARX.08.SQ | ACX.01.SQ | | ACX.02.SQ + ARX.07.SQ | ARX.15.SQ | ARX.10.SQ |
| | | | | | | | |



Ferramenta a nastro

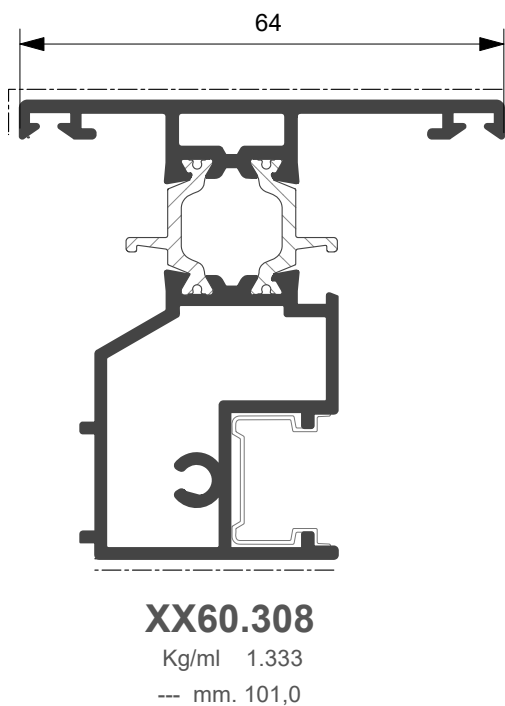
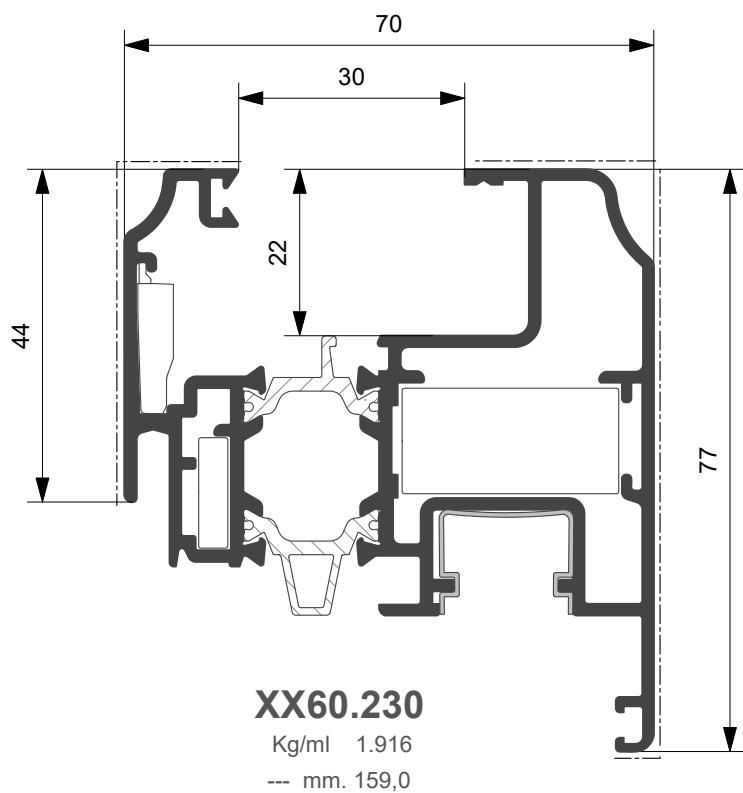
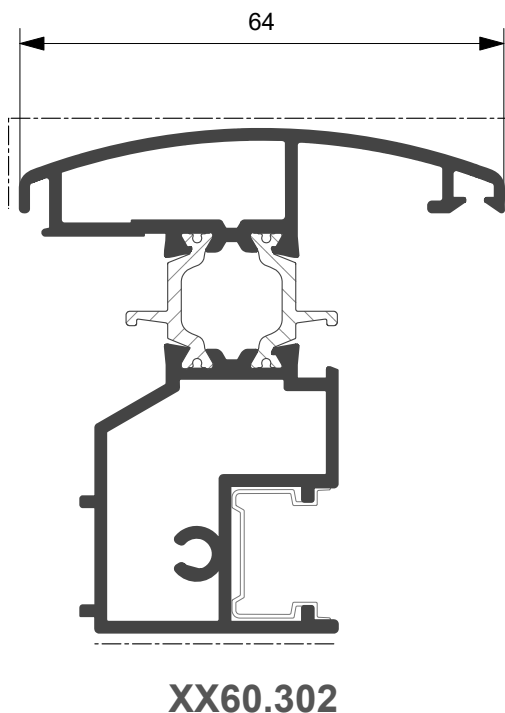
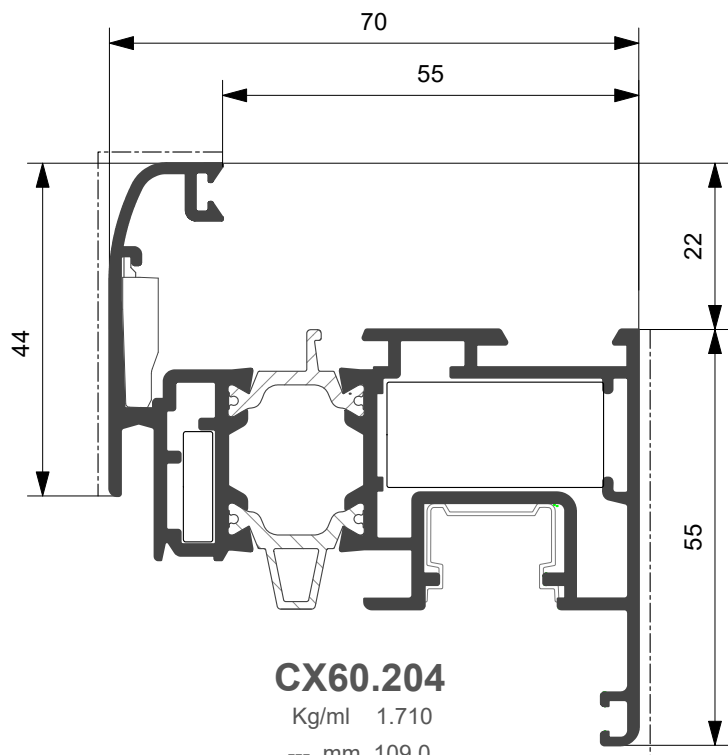

| Profilato | Squadretta esterna | | Squadretta interna | | | Squadretta allineamento | |
|-----------|--------------------|-----------------------|--------------------|-------------|-----------------------|-------------------------|---------|
| | Cianfrinare | Spinare | Bottone | Cianfrinare | Spinare | Esterna | Interna |
| CX60.204 | ARX.03.SQ | ARX.03.SQ + ARX.08.SQ | ACX.01.SQ | ACX.02.SQ | ACX.02.SQ + ARX.07.SQ | ARX.15.SQ | |
| XX60.230 | ARX.03.SQ | ARX.03.SQ + ARX.08.SQ | ACX.01.SQ | ACX.02.SQ | ACX.02.SQ + ARX.07.SQ | ARX.15.SQ | |
| | | | | | | | |

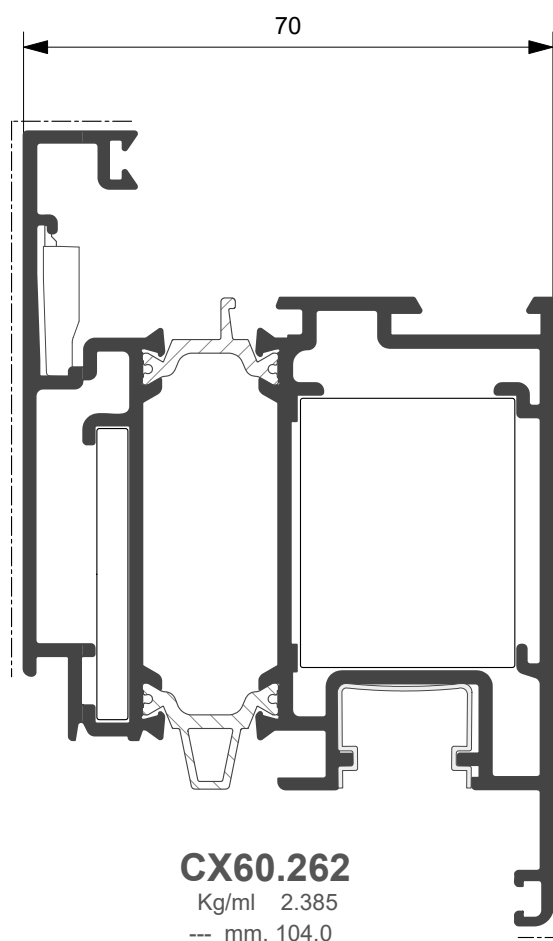
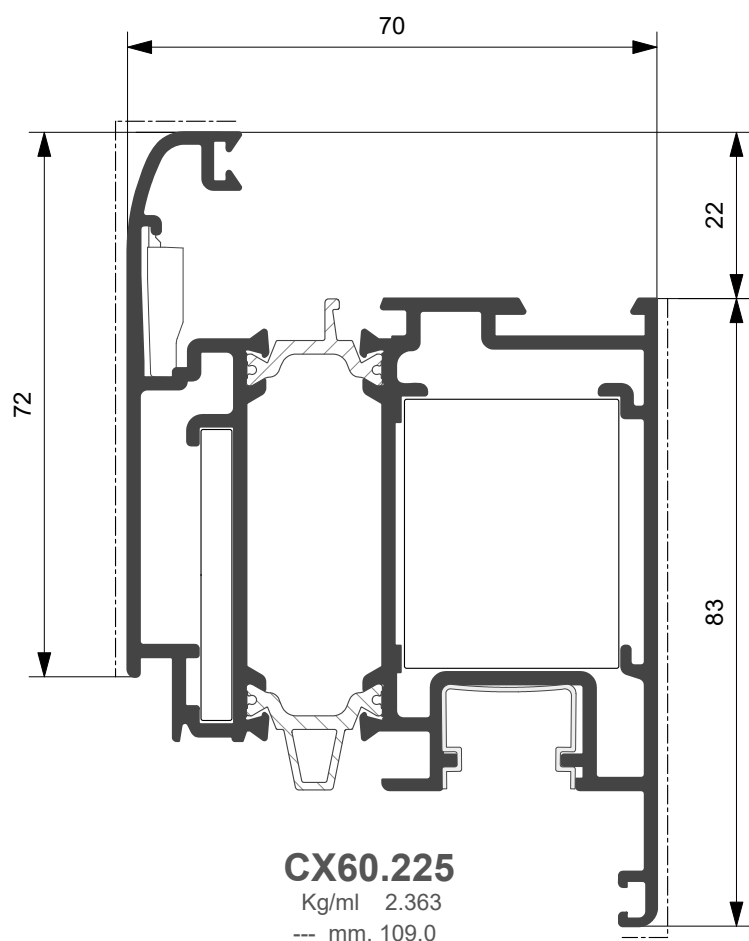
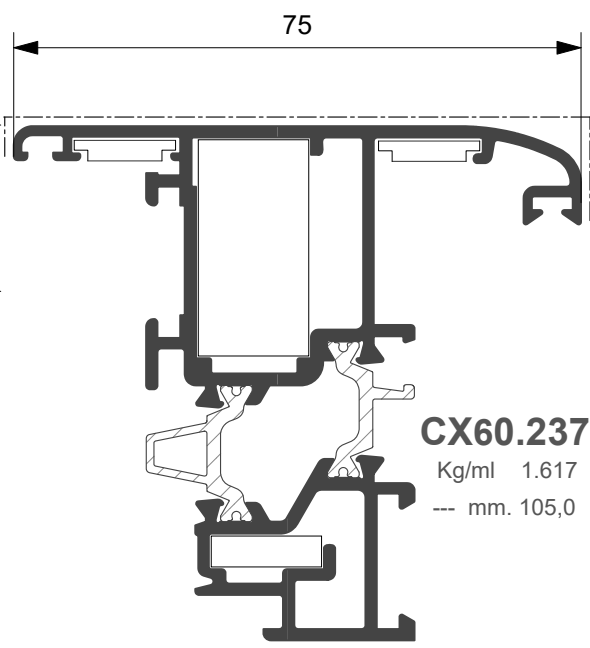
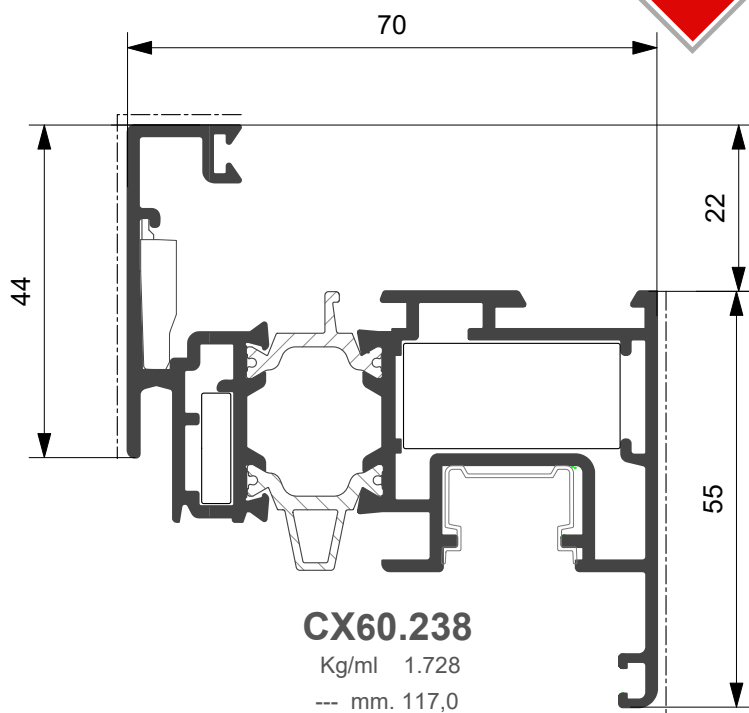

| Profilato | Squadretta esterna | | Squadretta interna | | | Squadretta allineamento | |
|-----------|--------------------|-----------------------|--------------------|-------------|-----------------------|-------------------------|---------|
| | Cianfrinare | Spinare | Bottone | Cianfrinare | Spinare | Esterna | Interna |
| CX60.225 | ARX.06.SQ | ARX.06.SQ + ARX.08.SQ | ACX.04.SQ | | ACX.14.SQ | ARX.15.SQ | |
| CX60.237 | ARX.03.SQ | ARX.03.SQ + ARX.08.SQ | ACX.01.SQ | ACX.02.SQ | ACX.02.SQ + ARX.07.SQ | ARX.15.SQ | |
| CX60.238 | ARX.03.SQ | ARX.03.SQ + ARX.08.SQ | ACX.01.SQ | ACX.02.SQ | ACX.02.SQ + ARX.07.SQ | ARX.10.SQ | |
| CX60.262 | ARX.06.SQ | ARX.06.SQ + ARX.08.SQ | ACX.04.SQ | | ACX.14.SQ | ARX.15.SQ | |



Ante sormonto 10 mm.

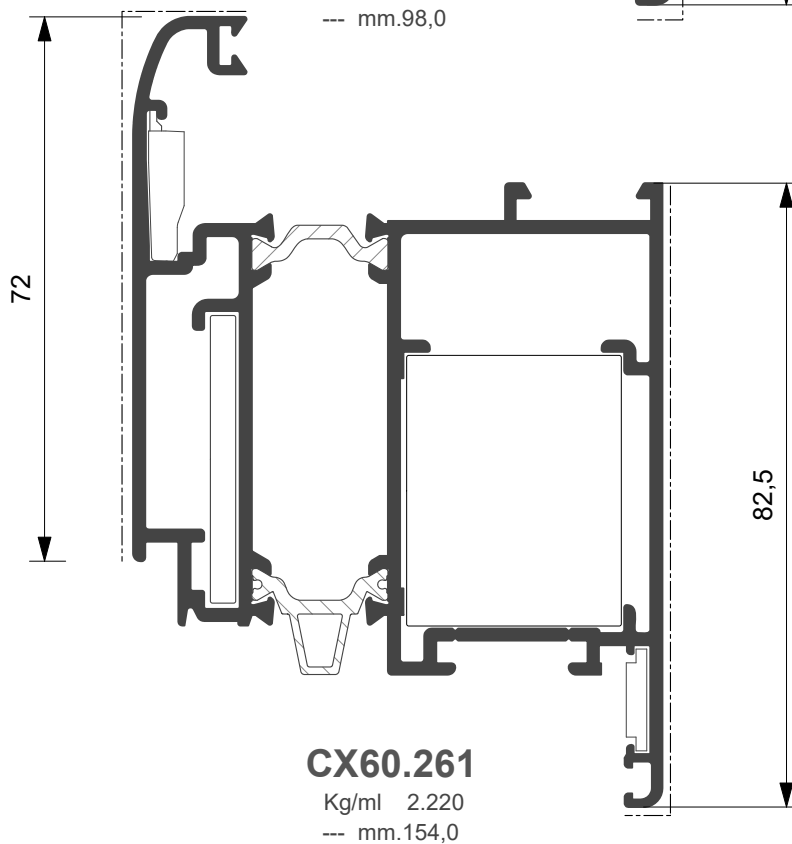
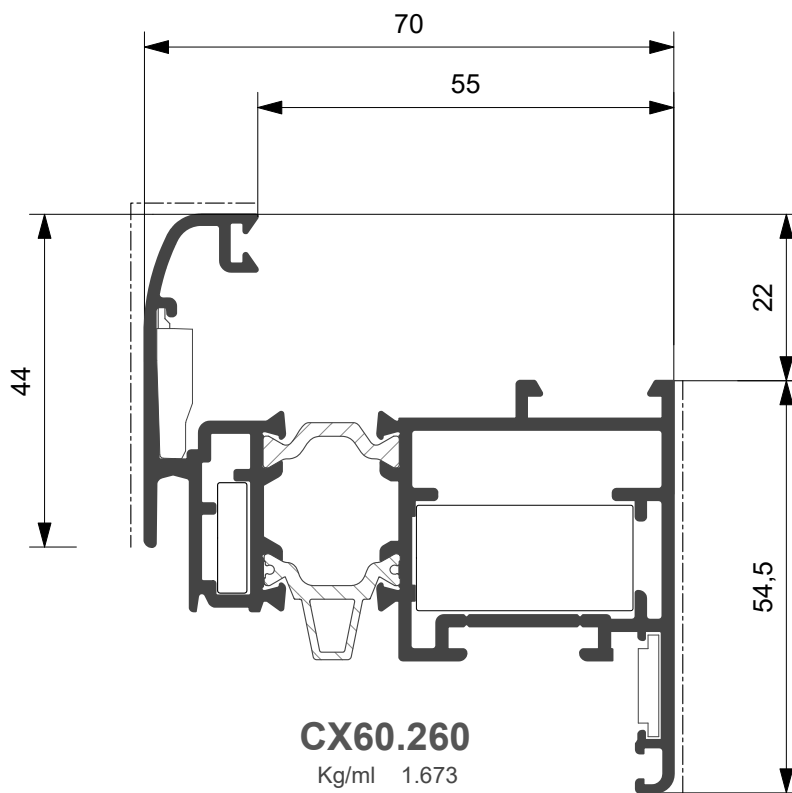

| Profilato | Squadretta esterna | | Squadretta interna | | | Squadretta allineamento | |
|-----------|--------------------|-----------------------|--------------------|-------------|-----------------------|-------------------------|-----------|
| | Cianfrinare | Spinare o Avvitare | Bottone | Cianfrinare | Spinare | Esterna | Interna |
| CX60.260 | ARX.03.SQ | ARX.03.SQ + ARX.08.SQ | ACX.01.SQ | | ACX.02.SQ + ARX.07.SQ | ARX.15.SQ | ARX.10.SQ |
| CX60.261 | ARX.06.SQ | ARX.06.SQ + ARX.08.SQ | ACX.04.SQ | ACX.14.SQ | ACX.14.SQ | ARX.15.SQ | ARX.10.SQ |
| | | | | | | | |

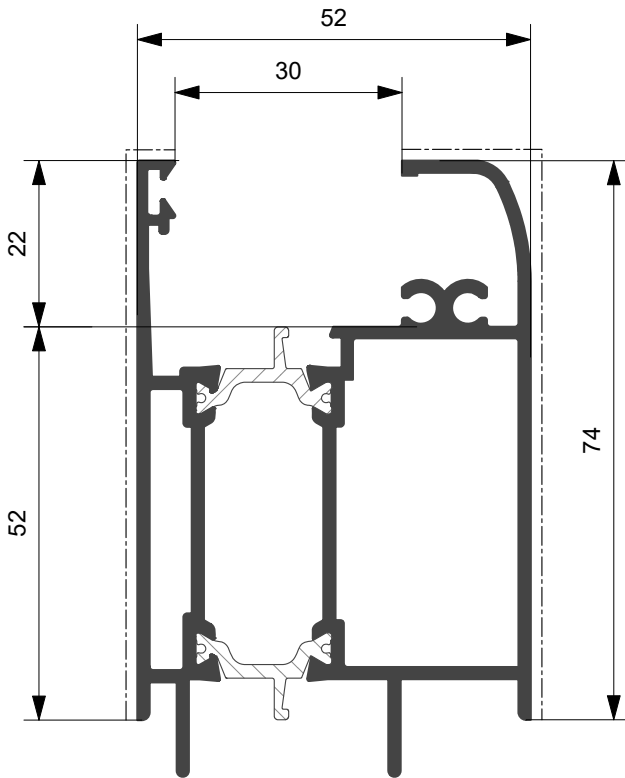

XX60.407

Kg/ml 1.808

--- mm. 162,0

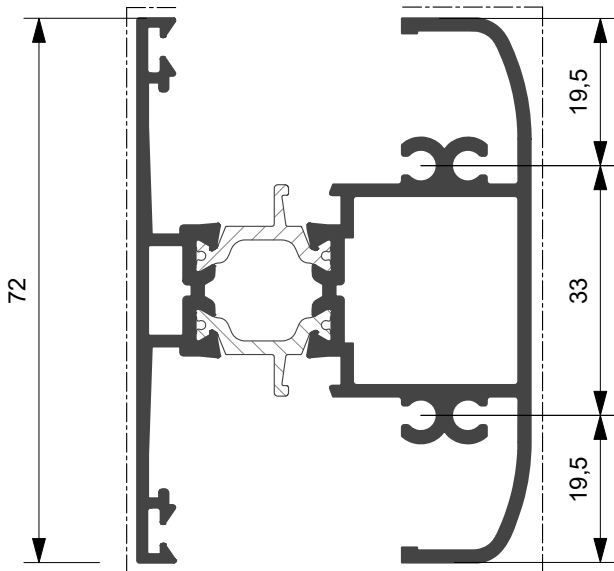

XX60.405

Kg/ml 1.653

--- mm. 1700

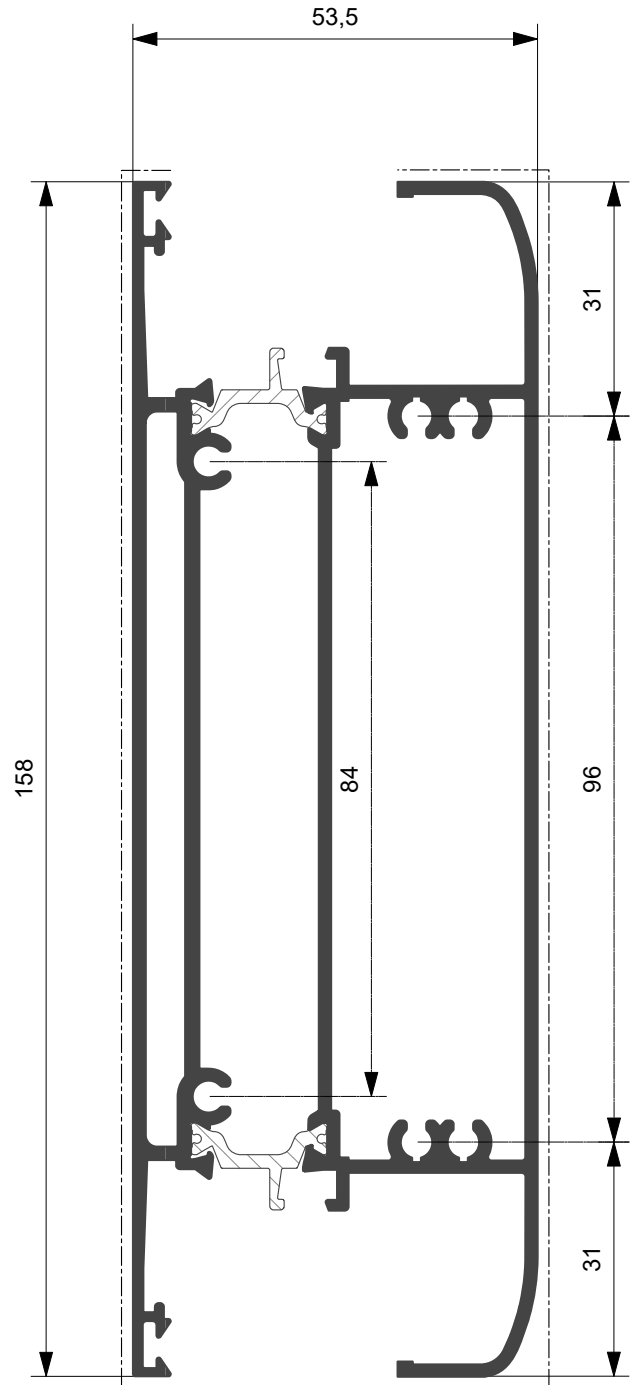

XX60.406

Kg/ml 3.360

--- mm. 332,0

| Profilato | Squadretta esterna | | Squadretta interna | | | Squadretta allineamento | |
|-----------|--------------------|---------|--------------------|-------------|---------|-------------------------|---------|
| | Cianfrinare | Spinare | Bottone | Cianfrinare | Spinare | Esterna | Interna |
| | | | | | | | |
| | | | | | | | |
| | | | | | | | |

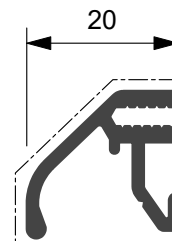
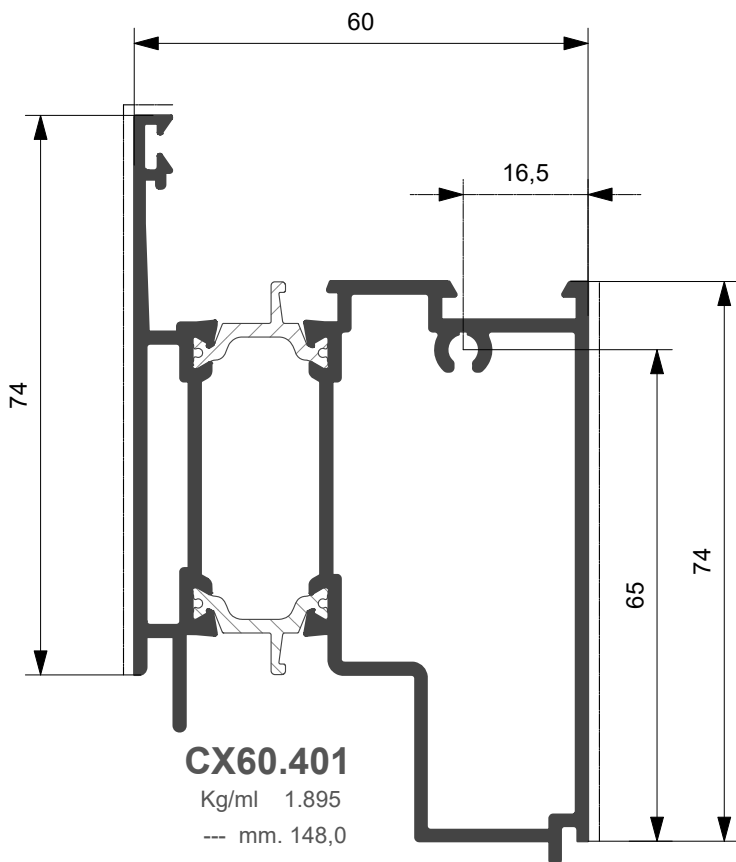

XX70.601

Kg/ml 0.269

--- mm. 28,0

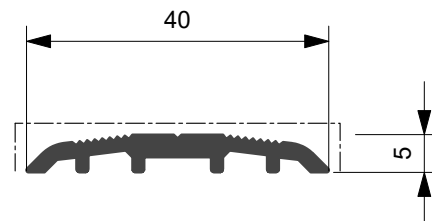

XX70.603

Kg/ml 0.275

--- mm. 40,0

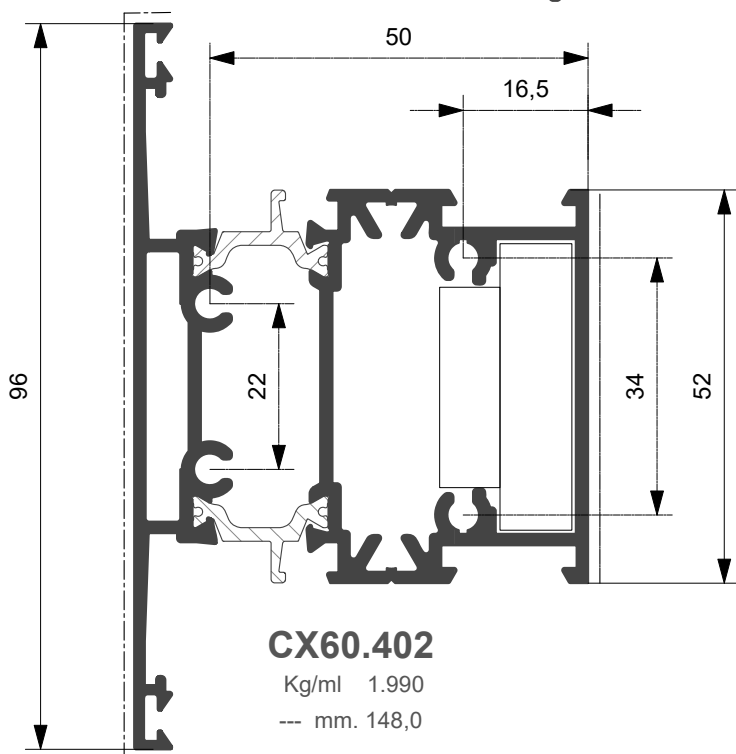

XX70.602

Kg/ml 0.372

--- mm. 22,0

| Profilato | Squadretta esterna | | Squadretta interna | | | Squadretta allineamento | |
|-----------|--------------------|---------|--------------------|-------------|---------|-------------------------|---------|
| | Cianfrinare | Spinare | Bottone | Cianfrinare | Spinare | Esterna | Interna |
| | | | | | | | |
| | | | | | | | |
| | | | | | | | |

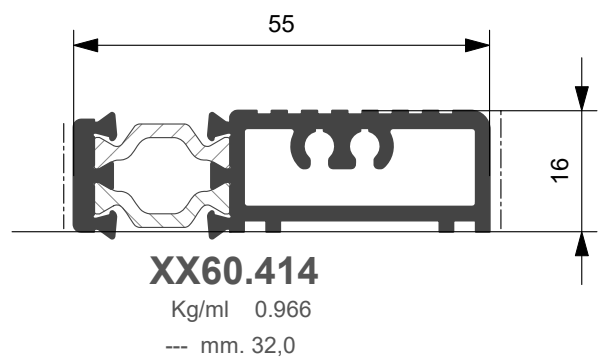
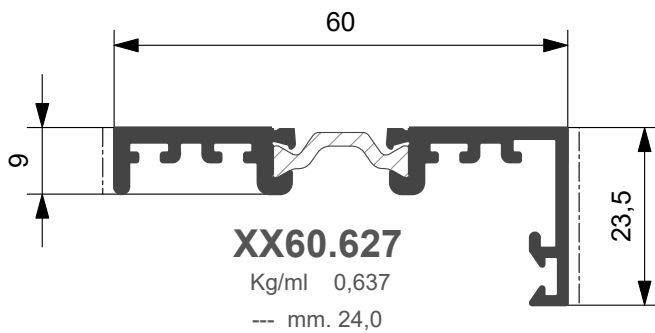
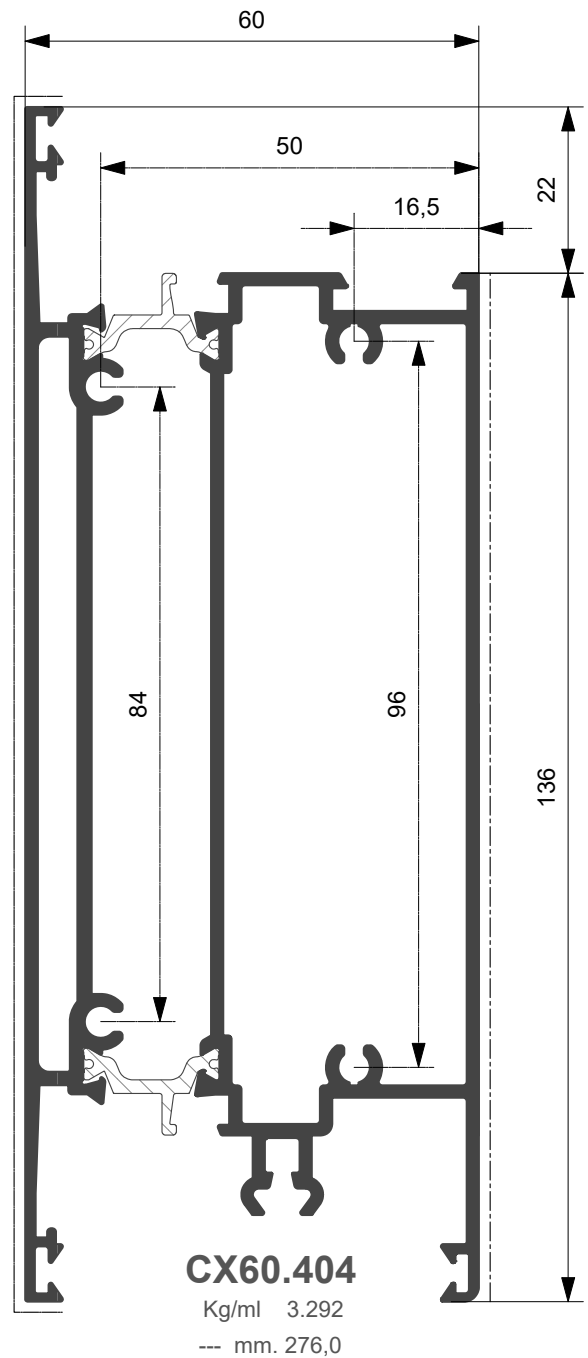
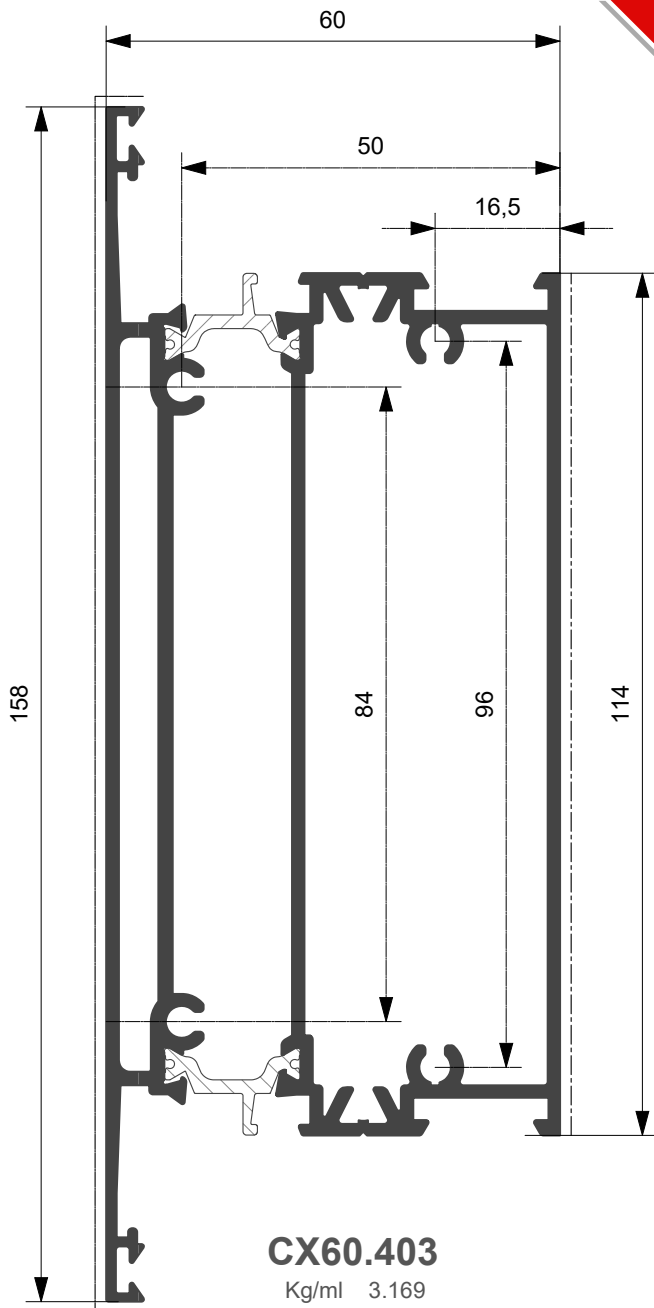

| Profilato | Squadretta esterna | | Squadretta interna | | | Squadretta allineamento | |
|-----------|--------------------|---------|--------------------|-------------|---------|-------------------------|---------|
| | Cianfrinare | Spinare | Bottone | Cianfrinare | Spinare | Esterna | Interna |
| | | | | | | | |
| | | | | | | | |
| | | | | | | | |

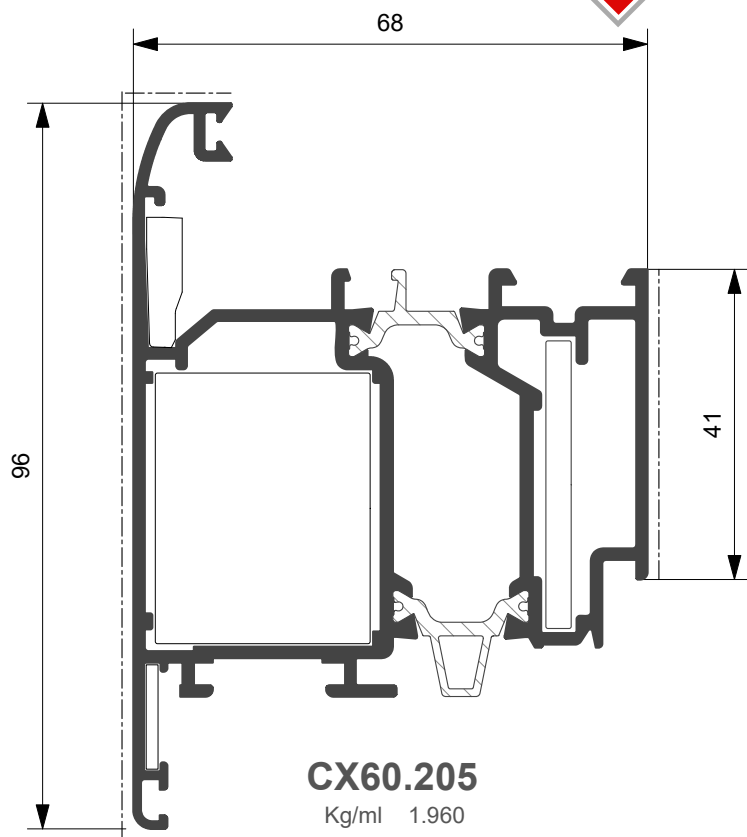

CX60.205

Kg/ml 1.960
--- mm. 147,0

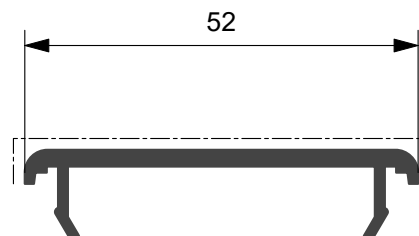

RX70.609

Kg/ml 0,393
--- mm. 55,0

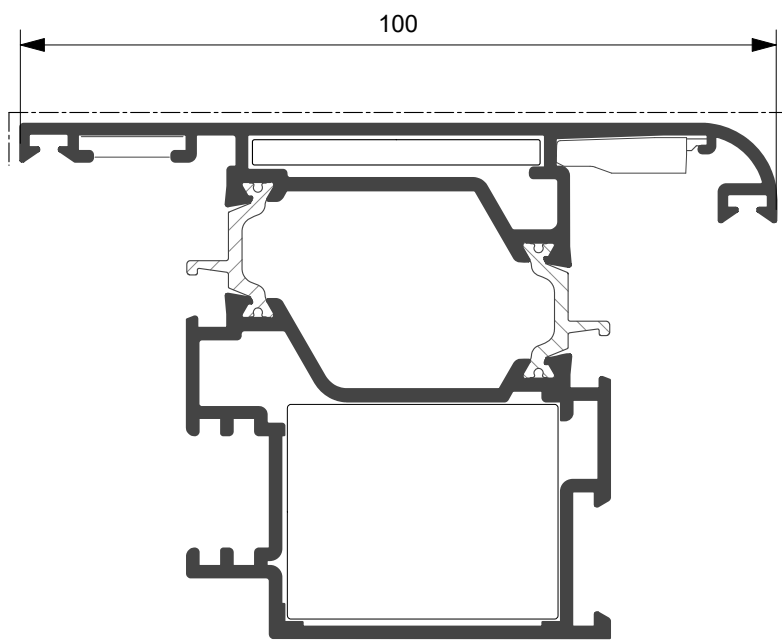

CX60.207

Kg/ml 2.010
--- mm. 155,0

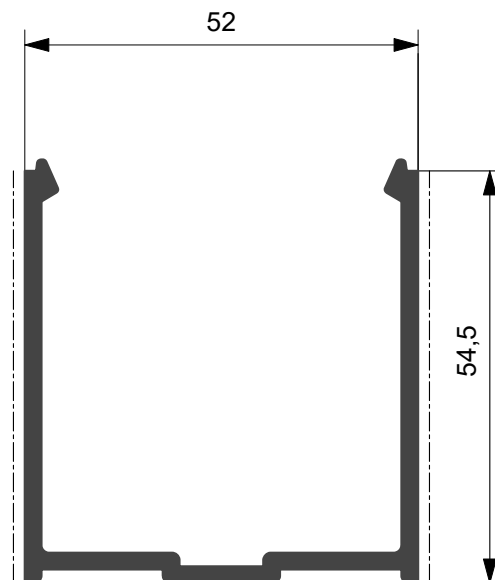

RX70.610

Kg/ml 0,994
--- mm. 109,0

| Profilato | Squadretta esterna | | Squadretta interna | | | Squadretta allineamento | |
|-----------|--------------------|-----------------------|--------------------|-------------|---------|-------------------------|-----------|
| | Cianfrinare | Spinare | Bottone | Cianfrinare | Spinare | Esterna | Interna |
| CX60.205 | ARX.06.SQ | ARX.06.SQ + ARX.08.SQ | ACX.04.SQ | | | ARX.09.SQ | ARX.10.SQ |
| CX60.207 | ARX.06.SQ | | ACX.04.SQ | | | ARX.09.SQ | ARX.10.SQ |

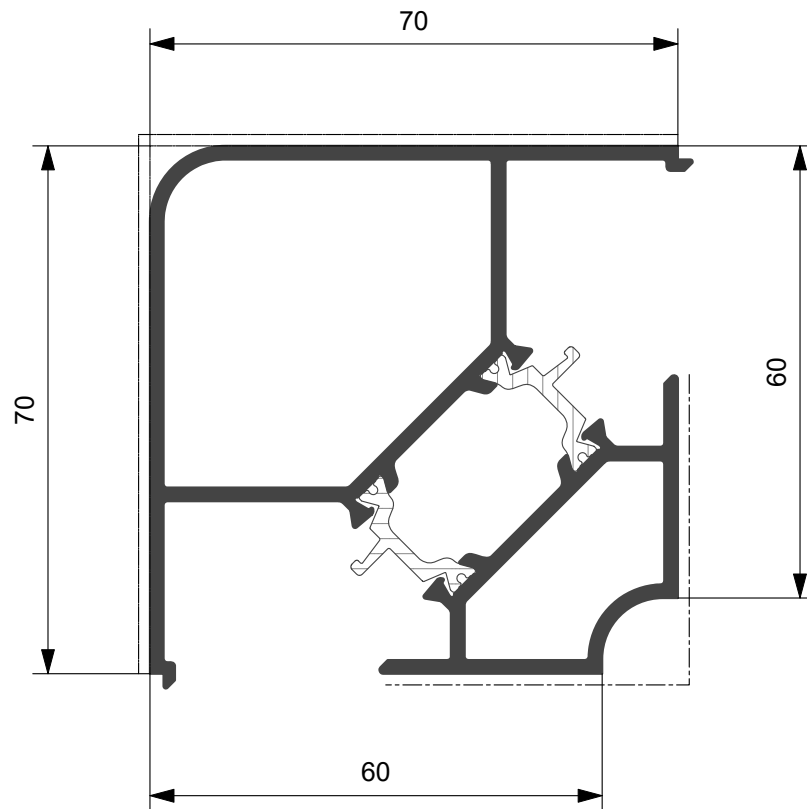

XX70.613

Kg/ml 1,885
--- mm. 215,0

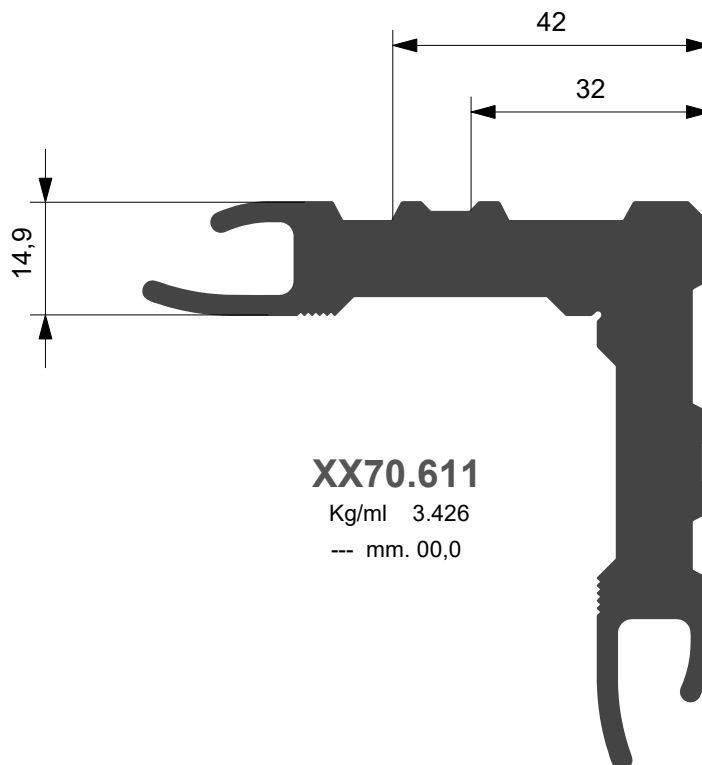

XX70.611

Kg/ml 3.426
--- mm. 00,0

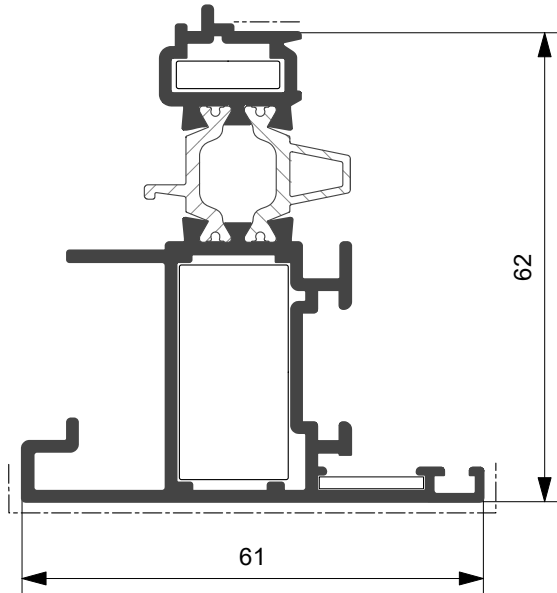

CX60.303

Kg/ml 1.352
--- mm. 64,0

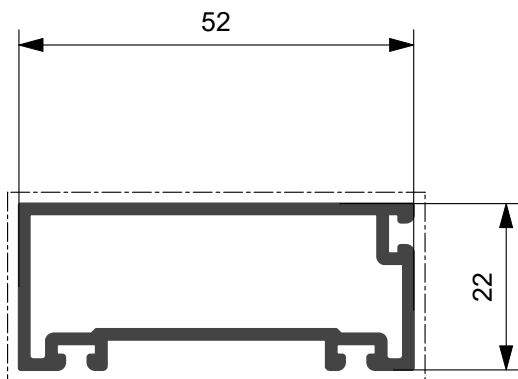

XX60.626

Kg/ml 0.640
--- mm. 140,0

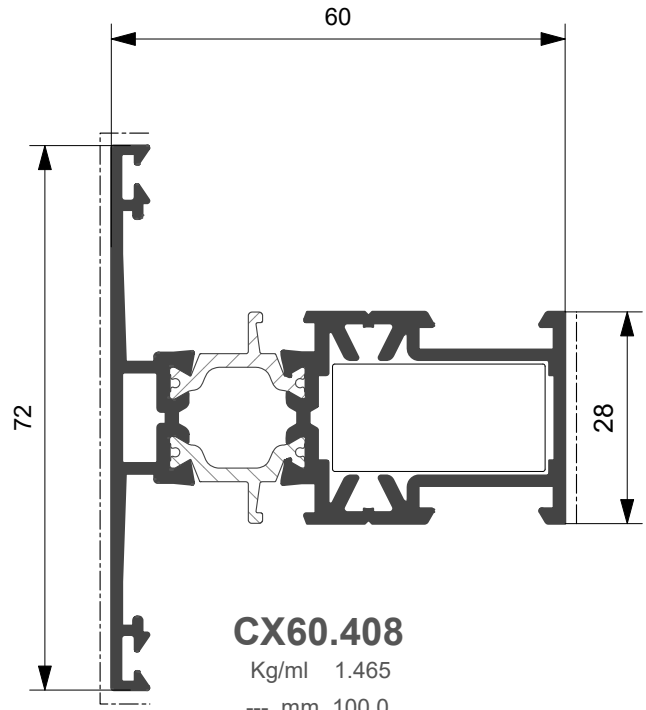

CX60.408

Kg/ml 1.465
--- mm. 100,0

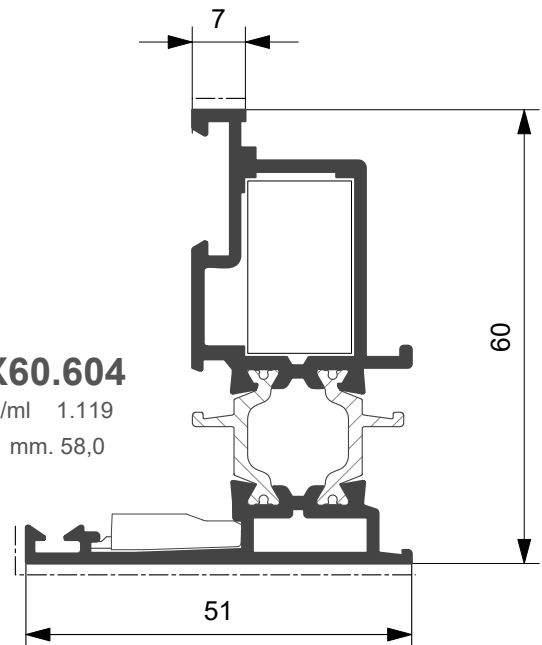

CX60.604

Kg/ml 1.119
--- mm. 58,0

| Profilato | Squadretta esterna | | Squadretta interna | | | Squadretta allineamento | |
|-----------|--------------------|-----------------------|--------------------|-------------|-----------------------|-------------------------|-----------|
| | Cianfrinare | Spinare | Bottone | Cianfrinare | Spinare | Esterna | Interna |
| CX60.303 | ARX.03.SQ | ARX.03.SQ + ARX.08.SQ | ACX.01.SQ | ACX.02.SQ | ACX.02.SQ + ARX.07.SQ | | ARX.10.SQ |
| CX60.604 | ARX.03.SQ | ARX.06.SQ + ARX.08.SQ | ARX.13.SQ | | | ARX.15.SQ | |
| | | | | | | | |

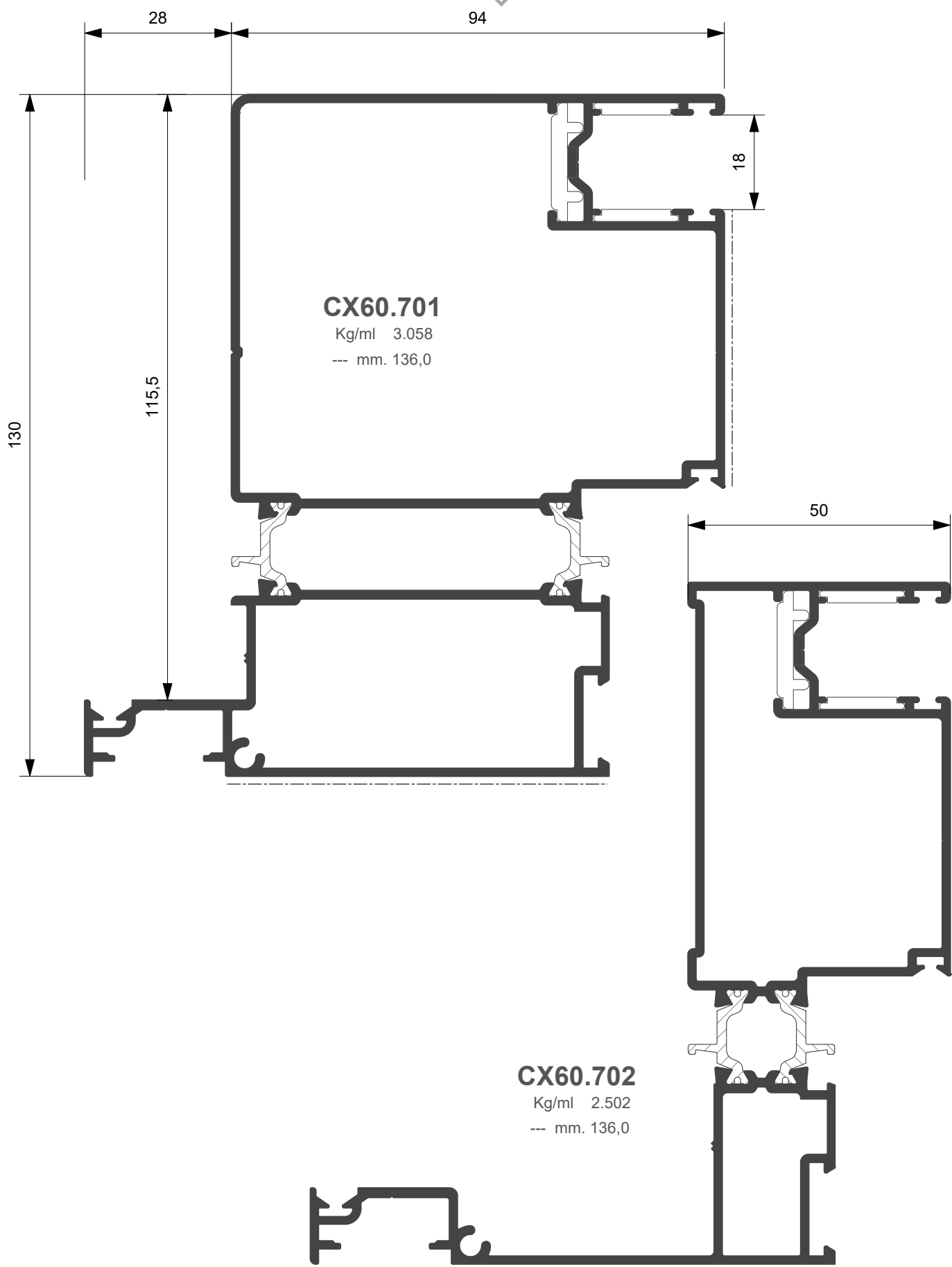

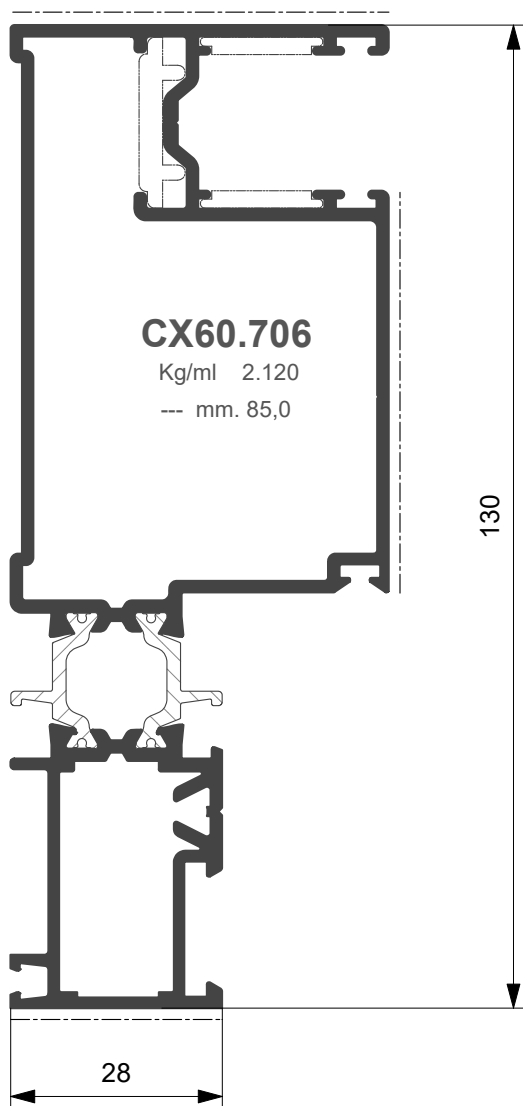

CX60.706
Kg/ml 2.120
--- mm. 85,0



XX70.705
Kg/ml 0.155
--- mm. 000,0

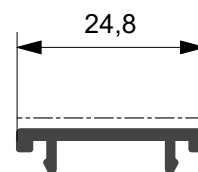

XX70.704
Kg/ml 0.135
--- mm. 25,0

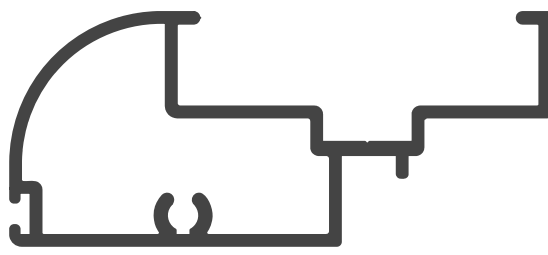

XX70.703
Kg/ml 0.791
--- mm. 43,0

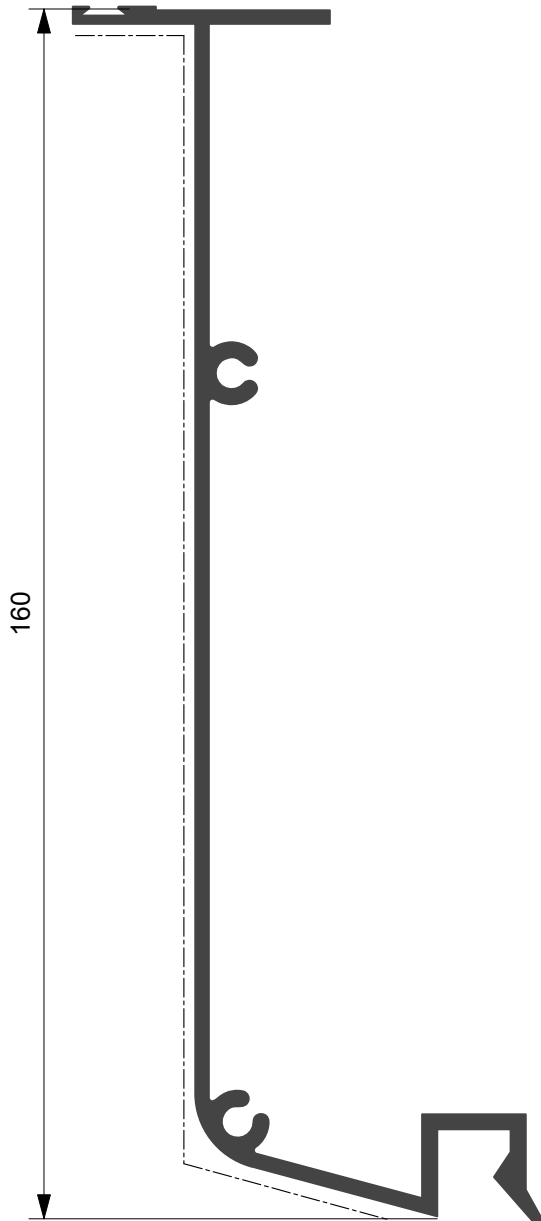

CX45.3363

Kg/ml 1.379
--- mm. 182,0

CX45.3362

Kg/ml 1.150
--- mm. 212,0

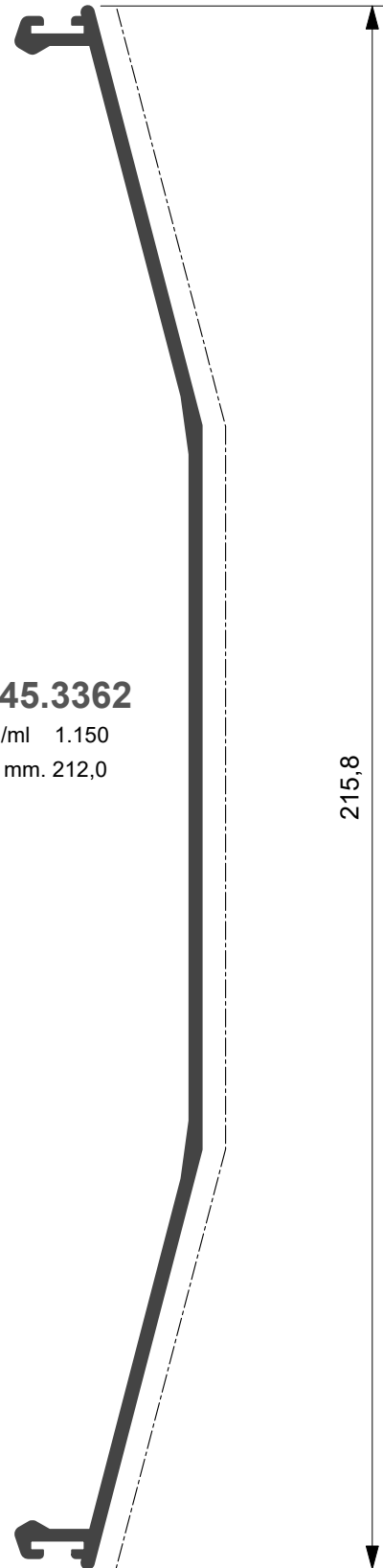

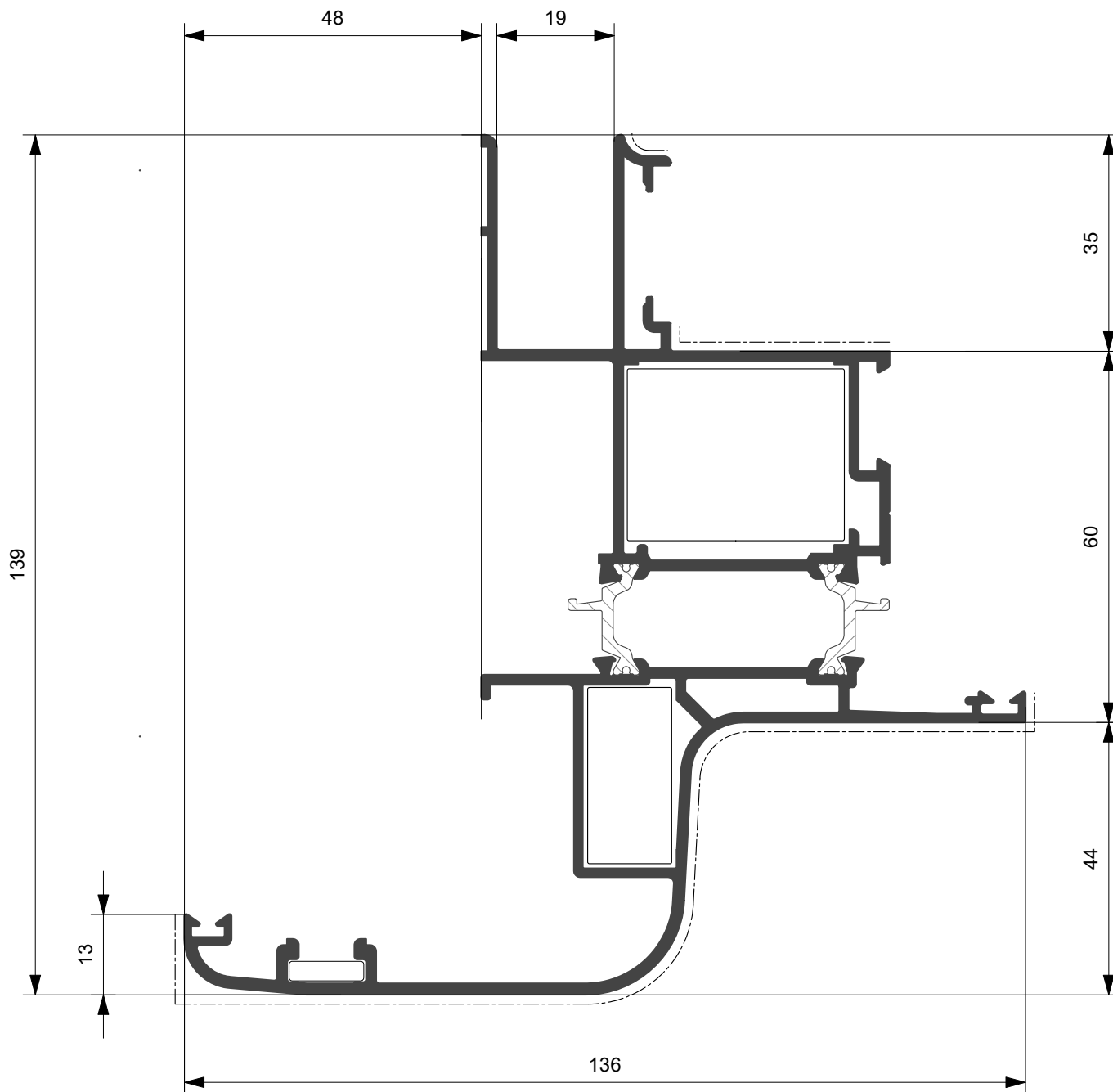

CX60.109

Kg/ml 2.937

--- mm. 242,0

| Profilato | Squadretta esterna | | Squadretta interna | | | Squadretta allineamento | |
|-----------|--------------------|-----------------------|--------------------|-------------|---------|-------------------------|-----------|
| | Cianfrinare | Spinare | Bottone | Cianfrinare | Spinare | Esterna | Interna |
| CX60.109 | ARX.01.SQ | ARX.02.SQ + ARX.07.SQ | ACX.04.SQ | | | ARX.15.SQ | ARX.10.SQ |
| | | | | | | | |

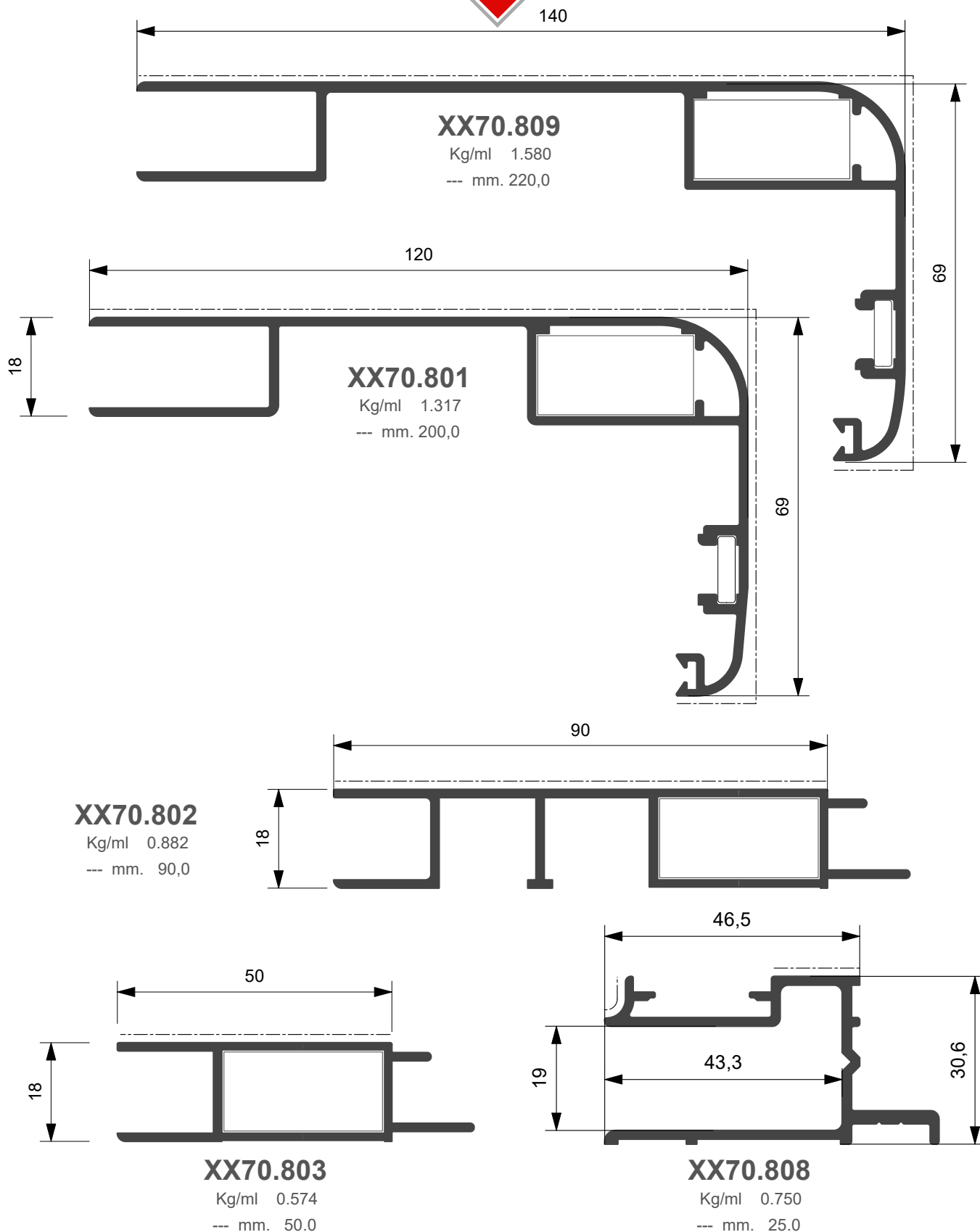

| Profilato | Squadretta esterna | | Squadretta interna | | | Squadretta allineamento | |
|-----------|--------------------|---------|--------------------|-------------|-----------------------|-------------------------|-----------|
| | Bottone | Spinare | Bottone | Cianfrinare | Spinare | Esterna | Interna |
| XX70.801 | | | ACX.01.SQ | ACX.02.SQ | ACX.02.SQ + ARX.07.SQ | | ARX.11.SQ |
| XX70.802 | | | ACX.01.SQ | ACX.02.SQ | ACX.02.SQ + ARX.07.SQ | | |
| XX70.803 | | | ACX.01.SQ | ACX.02.SQ | ACX.02.SQ + ARX.07.SQ | | |
| XX70.809 | | | ACX.01.SQ | ACX.02.SQ | ACX.02.SQ + ARX.07.SQ | | ARX.11.SQ |

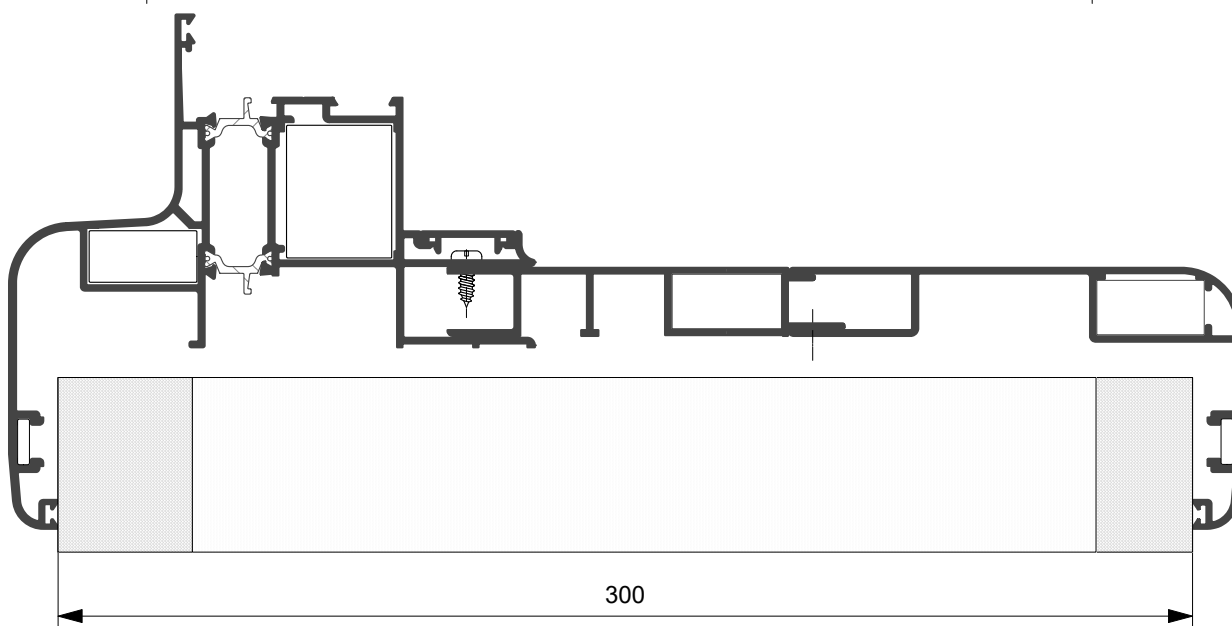
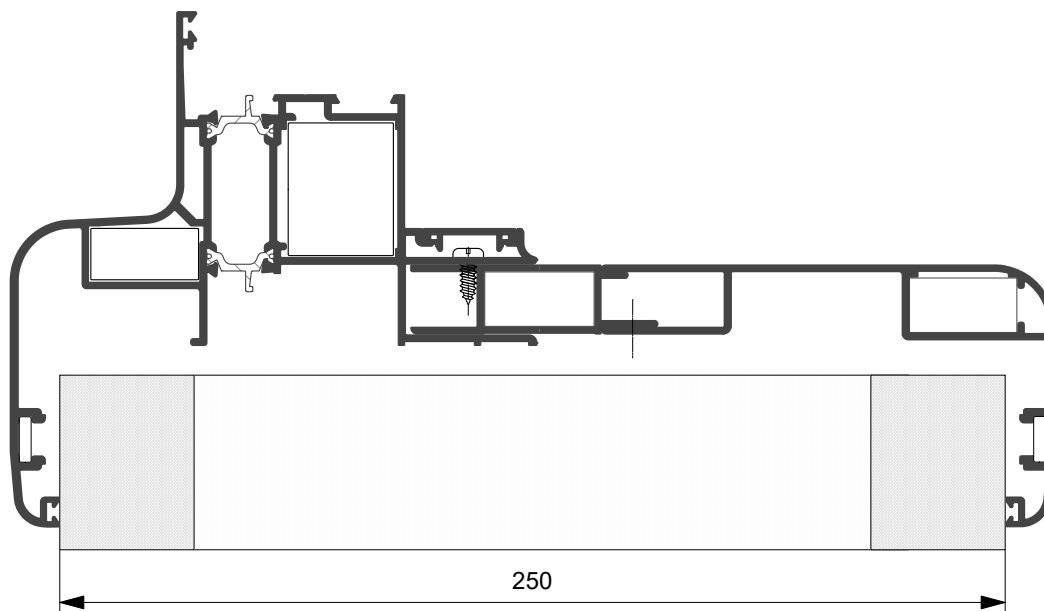
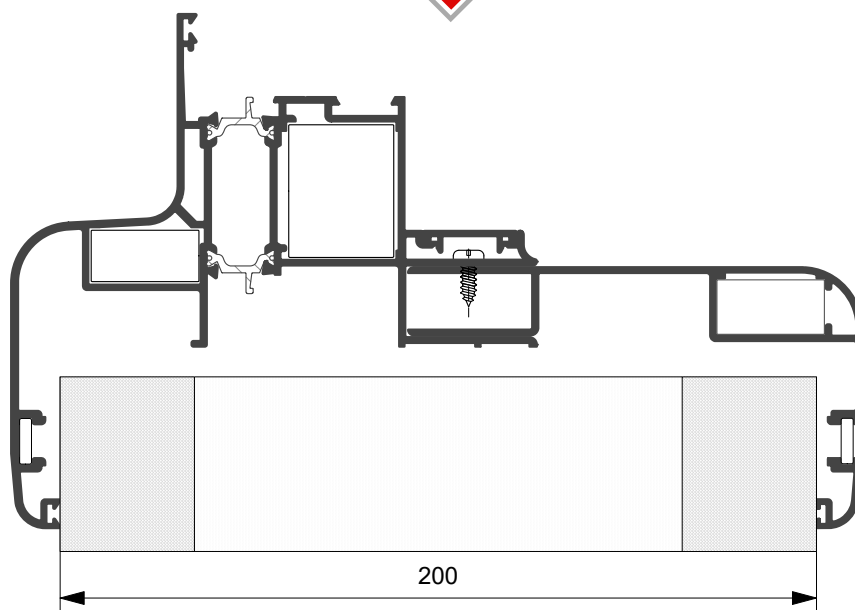



CX70.540

Kg/ml 0.2249
--- mm. 32,0

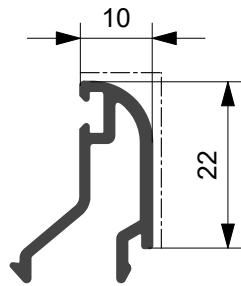

CX70.521

Kg/ml 0.266
--- mm. 36,0

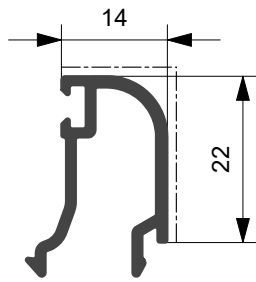

CX70.522

Kg/ml 0.277
--- mm. 40,0

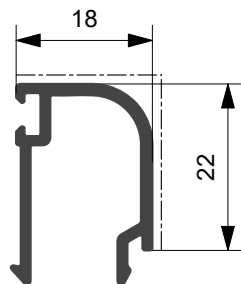

CX70.523

Kg/ml 0.294
--- mm. 44,0

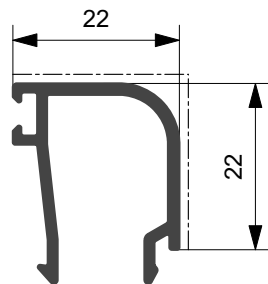

CX70.524

Kg/ml 0.314
--- mm. 48,0

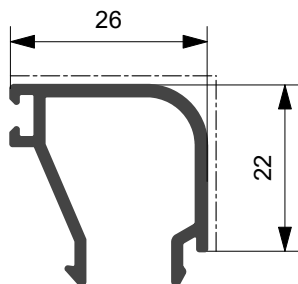

CX70.525

Kg/ml 0.350
--- mm. 52,0

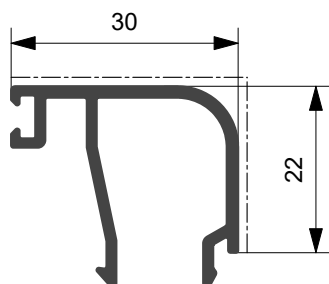

**APPLICAZIONE FERMAVETRI
TONDI**

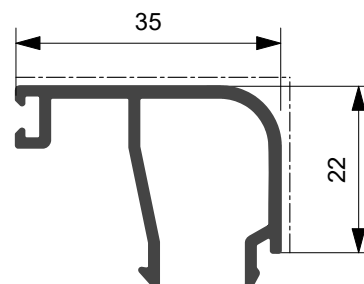
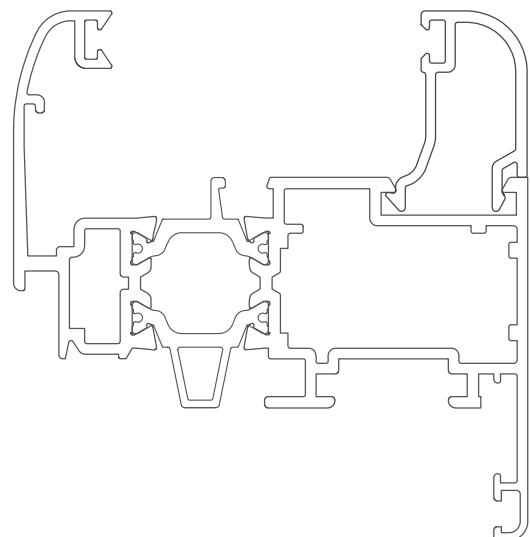

CX70.531

Kg/ml 0.370
--- mm. 57,0



CX70.533

Kg/ml 0.252
--- mm. 27,0

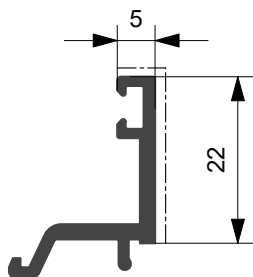

CX70.539

Kg/ml 0.245
--- mm. 27,0

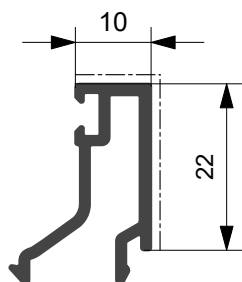

CX70.526

Kg/ml 0.279
--- mm. 36,0

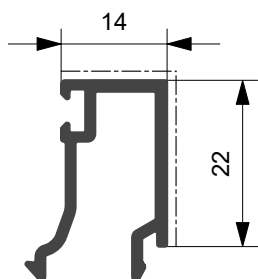

CX70.527

Kg/ml 0.290
--- mm. 40,0

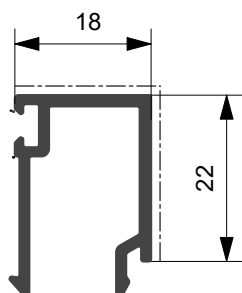

CX70.528

Kg/ml 0.307
--- mm. 44,0

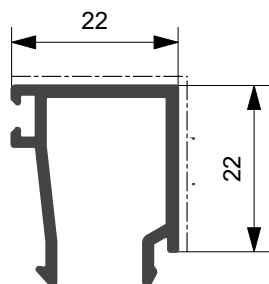

CX70.529

Kg/ml 0.327
--- mm. 48,0

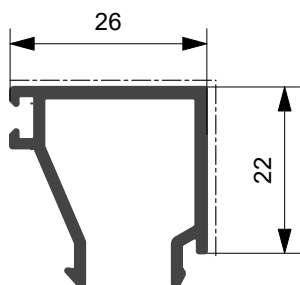

**APPLICAZIONE FERMAVETRI
DRITTI**

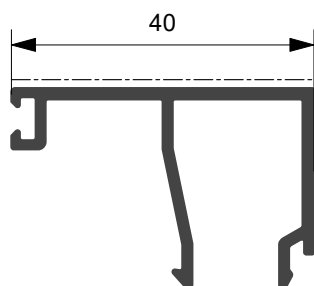
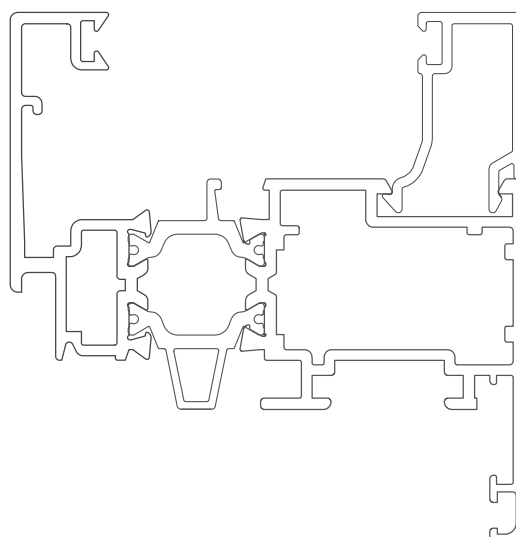

CX70.537

Kg/ml 0.403
--- mm. 62,0

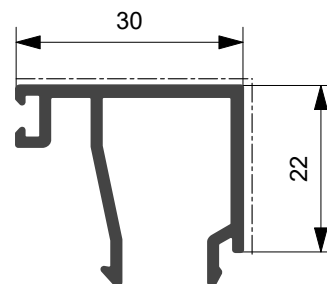

CX70.530

Kg/ml 0.362
--- mm. 52,0

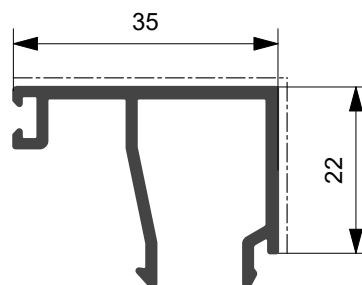

CX70.532

Kg/ml 0.383
--- mm. 57,0



CX70.571

Kg/ml 0.216
--- mm. 36,0

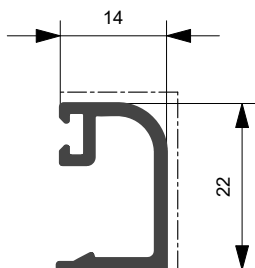

CX70.572

Kg/ml 0.262
--- mm. 40,0

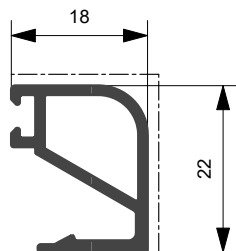

CX70.573

Kg/ml 0.283
--- mm. 44,0

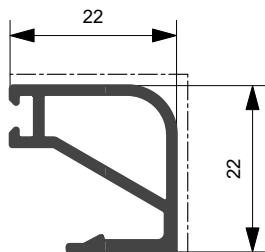

CX70.574

Kg/ml 0.313
--- mm. 48,0

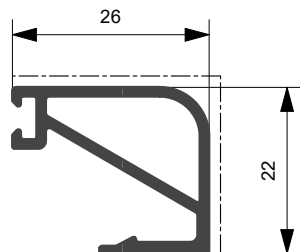

CX70.575

Kg/ml 0.340
--- mm. 52,0

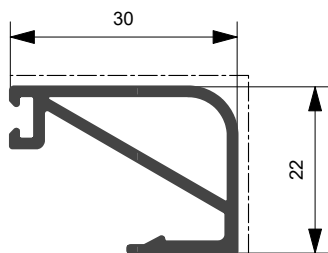

RX70.581

Kg/ml 0.361
--- mm. 57,0

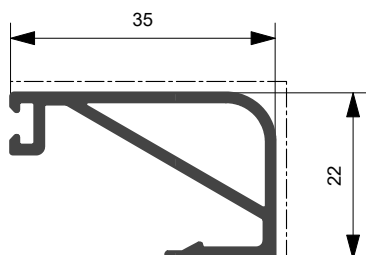

APPLICAZIONE FERMAVETRI CON CLIPS

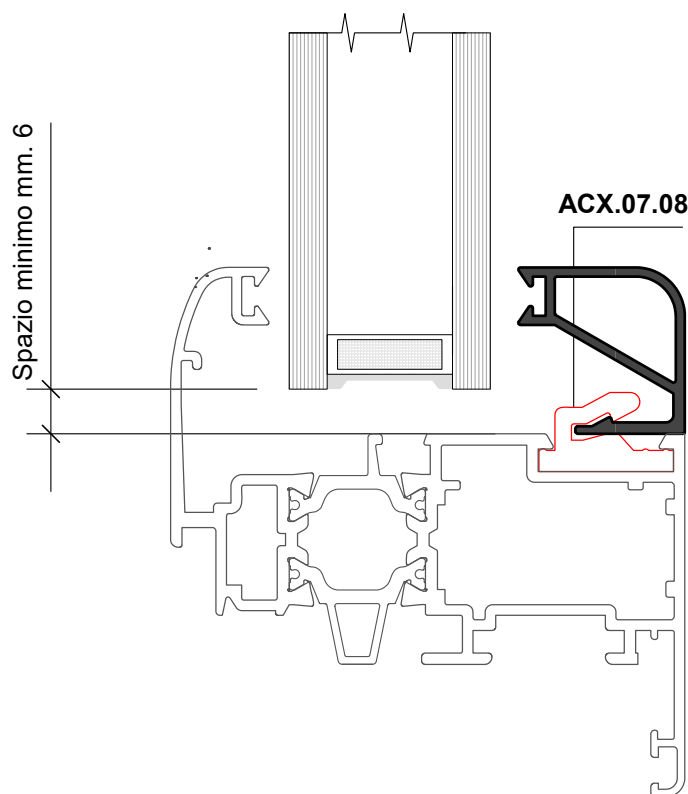

E' consigliabile l'abbinamento con fermavetri tradizionali tondi con taglio a 45° ,al fine di evitare gli angoli fermavetro in zama



CX70.568

Kg/ml 0.297
--- mm. 32,0

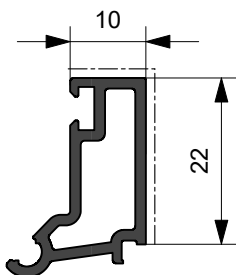

CX70.562

Kg/ml 0.324
--- mm. 36,0

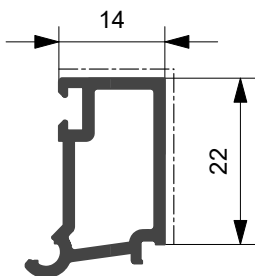

CX70.563

Kg/ml 0.330
--- mm. 40,0

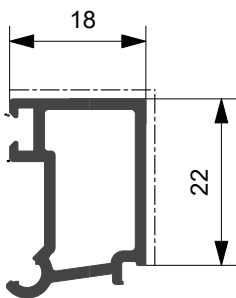

CX70.564

Kg/ml 0.348
--- mm. 44,0

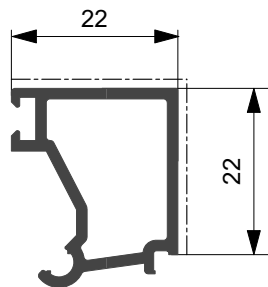

CX70.565

Kg/ml 0.372
--- mm. 48,0

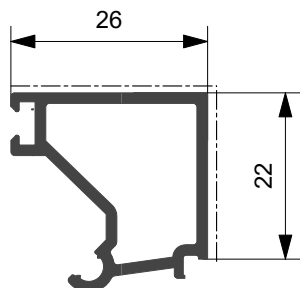

CX70.566

Kg/ml 0.396
--- mm. 52,0

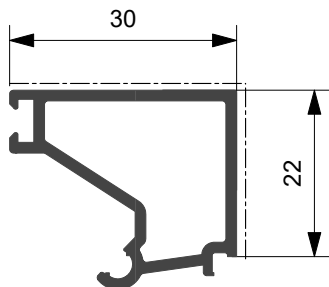

APPLICAZIONE FERMAVETRI DI SICUREZZA

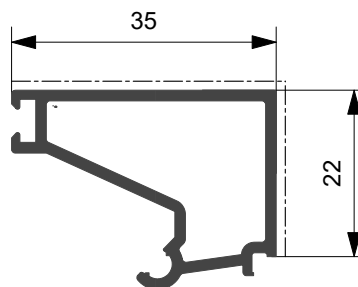
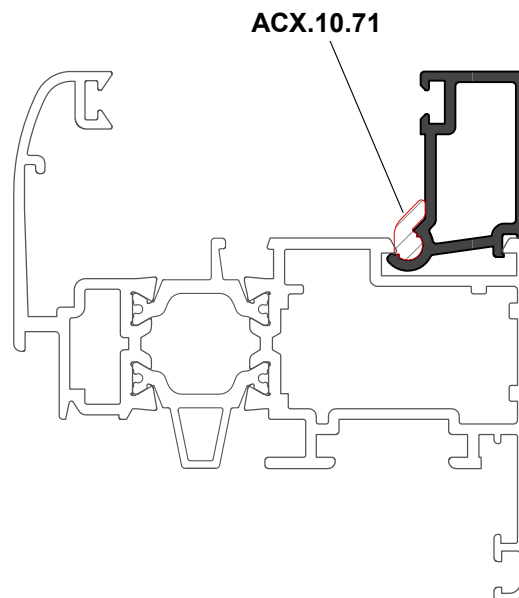

CX70.567

Kg/ml 0.434
--- mm. 57,0

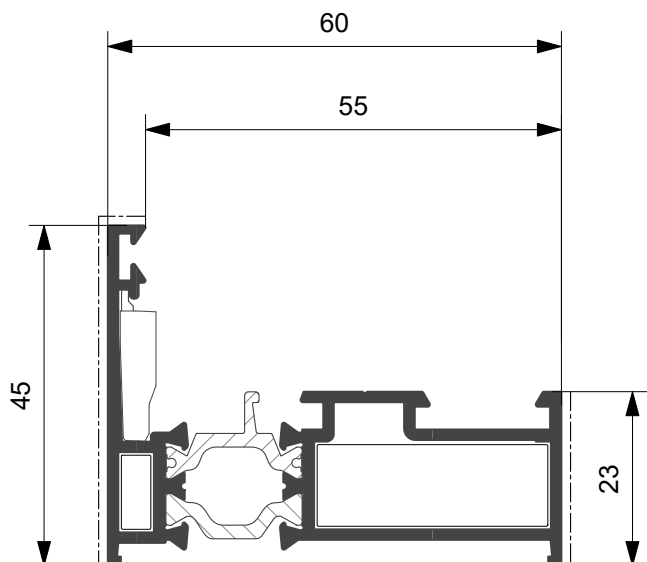

CX60S.101

Kg/ml 0.999
--- mm. 73

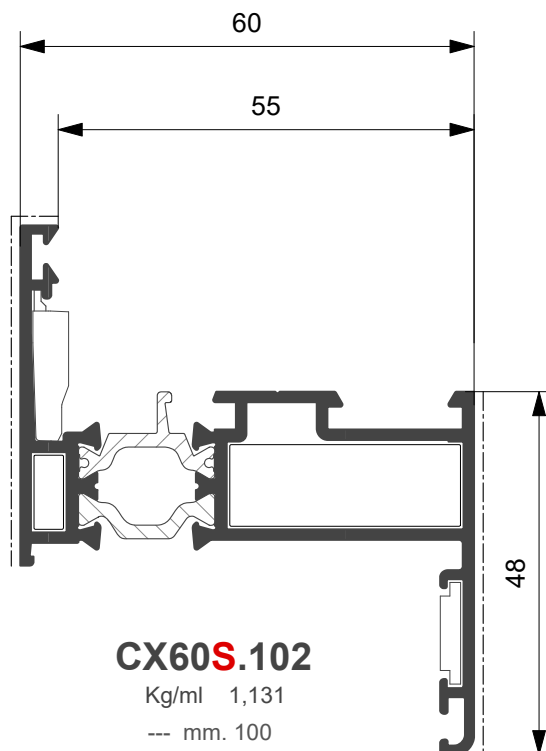

CX60S.102

Kg/ml 1,131
--- mm. 100

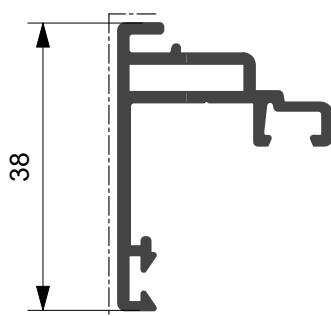

CX60S.304

Kg/ml 0.427
--- mm. 48

| Profilato | Squadretta esterna | | Squadretta interna | | | Squadretta allineamento | |
|-----------|--------------------|------------------------|--------------------|-------------|---------|-------------------------|-----------|
| | Cianfrinare | Con grano fissaggio | Bottone | Cianfrinare | Spinare | Esterna | Interna |
| CX60S.101 | ACX.36.SQ | ACX.36.SQ + GRLM4x5ECP | ACX.35.SQ | | | ARX.15.SQ | |
| CX60S.102 | ACX.36.SQ | ACX.36.SQ + GRLM4x5ECP | ACX.35.SQ | | | ARX.15.SQ | ARX.10.SQ |
| | | | | | | | |

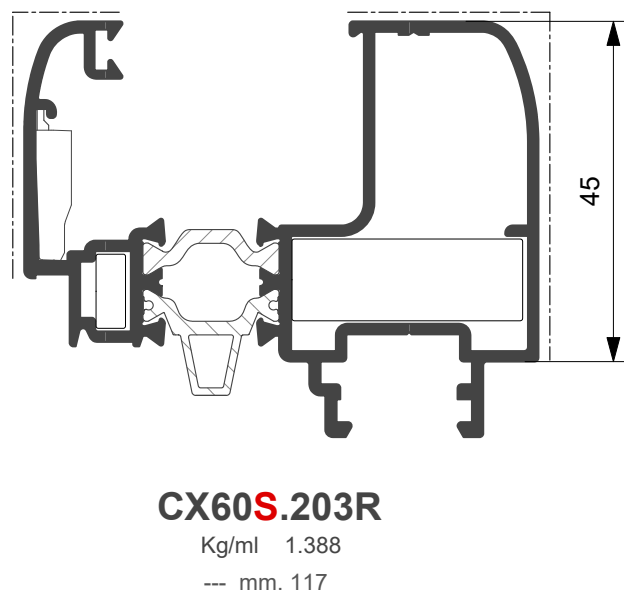
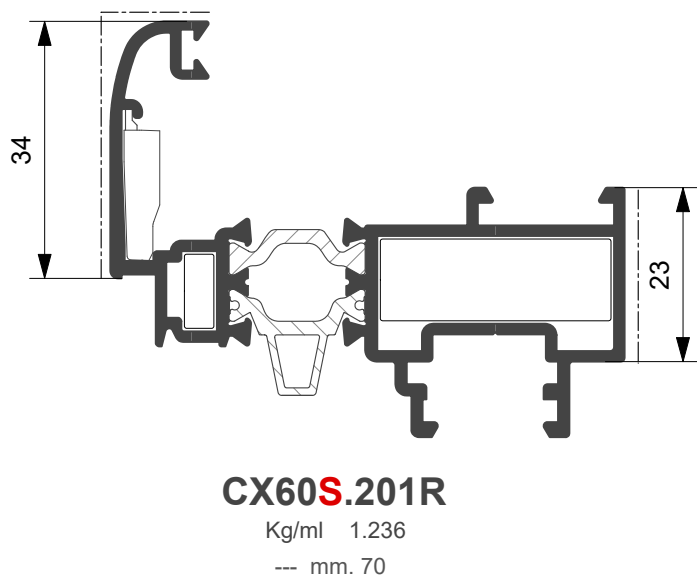
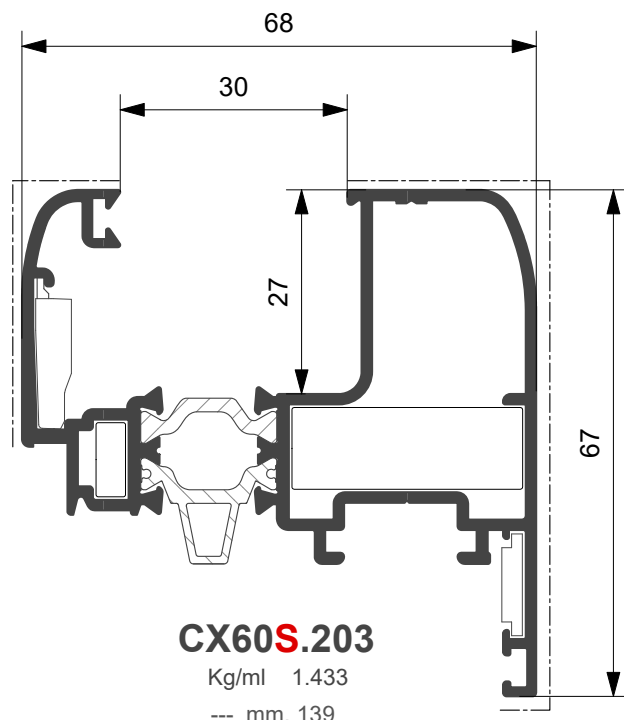
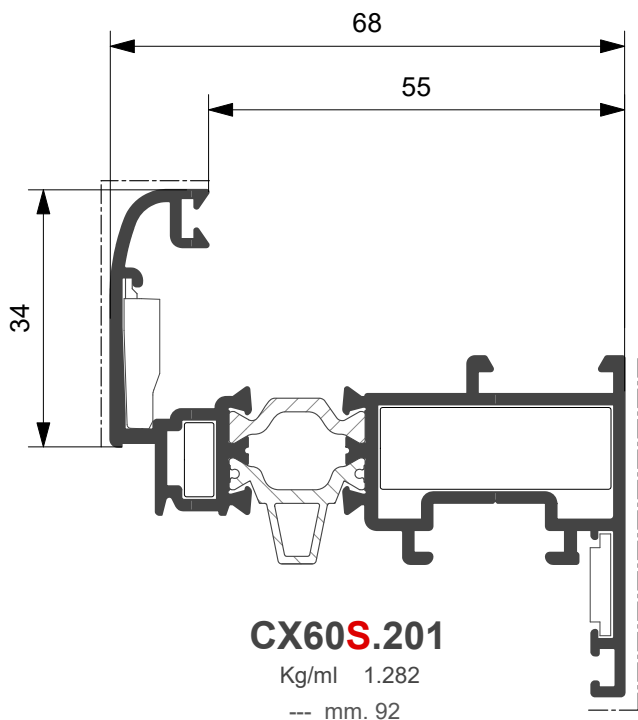

| Profilato | Squadretta esterna | | Squadretta interna | | | Squadretta allineamento | |
|------------|--------------------|------------------------|--------------------|-------------|---------|-------------------------|-----------|
| | Cianfrinare | Con grano fissaggio | Bottone | Cianfrinare | Spinare | Esterna | Interna |
| CX60S.201 | ACX.36.SQ | ACX.36.SQ + GRLM4x5ECP | ACX.35.SQ | | | ARX.15.SQ | ARX.10.SQ |
| CX60S.201R | ACX.36.SQ | ACX.36.SQ + GRLM4x5ECP | ACX.35.SQ | | | ARX.15.SQ | |
| CX60S.203 | ACX.36.SQ | ACX.36.SQ + GRLM4x5ECP | ACX.35.SQ | | | ARX.15.SQ | ARX.10.SQ |
| CX60S.203R | ACX.36.SQ | ACX.36.SQ + GRLM4x5ECP | ACX.35.SQ | | | ARX.15.SQ | |



Serie **ELEGANCE**

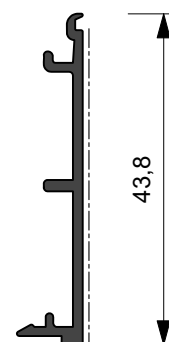
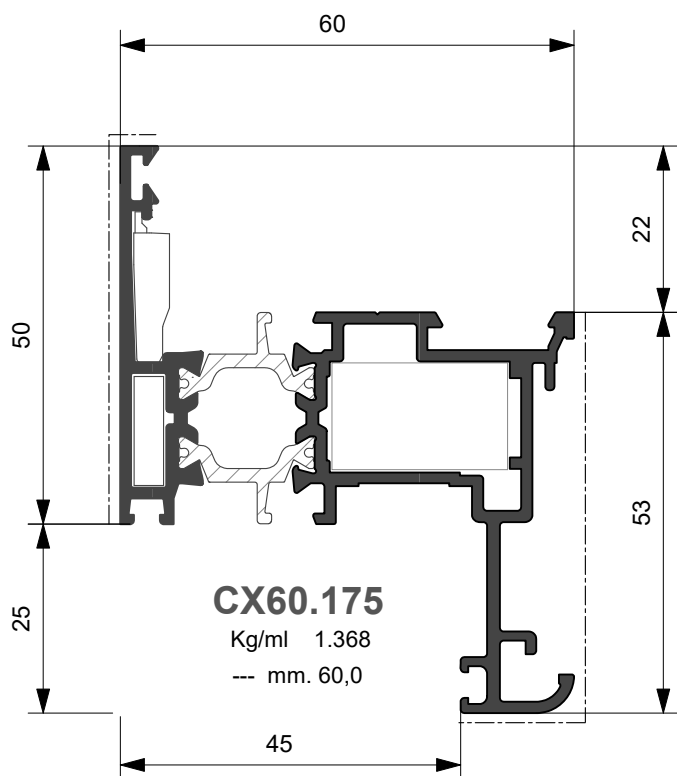

XX70.637
Kg/ml 0.219
--- mm. 44,0

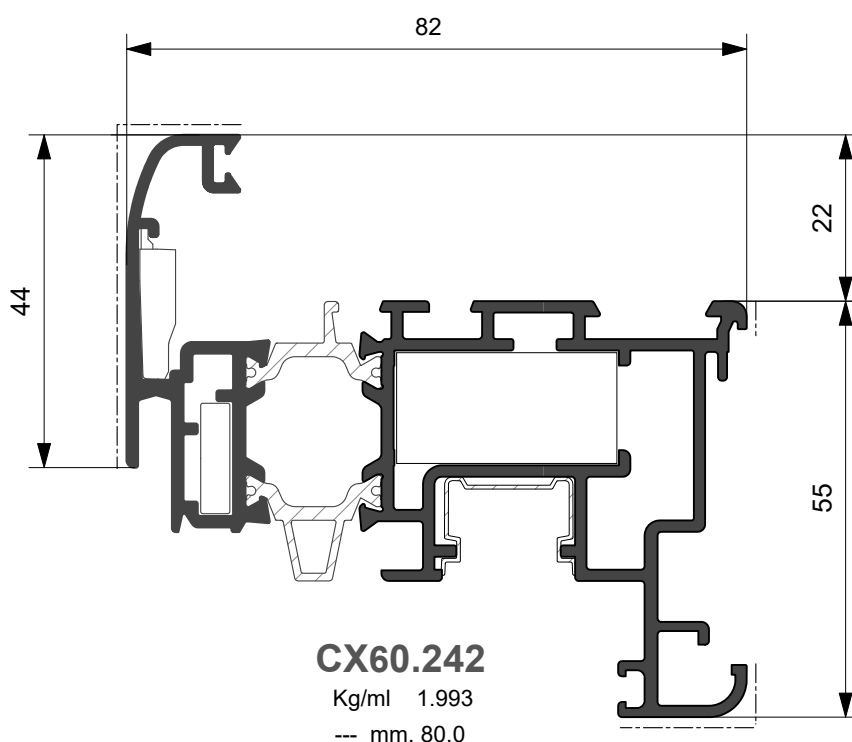

| Profilato | Squadretta esterna | | Squadretta interna | | | Squadretta allineamento | |
|-----------|--------------------|-----------------------|--------------------|-------------|-----------------------|-------------------------|---------|
| | Cianfrinare | Spinare | Bottone | Cianfrinare | Spinare | Esterna | Interna |
| CX60.175 | ARX.03.SQ | ARX.03.SQ + ARX.08.SQ | ARX.13.SQ | | | ARX.15.SQ | |
| CX60.242 | ARX.03.SQ | ARX.03.SQ + ARX.08.SQ | ACX.01.SQ | ACX.02.SQ | ACX.02.SQ + ARX.07.SQ | ARX.15.SQ | |
| | | | | | | | |



| Aletta (a) mm. | Vuoto (v) mm. | Dimensione fermavetro (f) mm. | Codice Fermavetro D = dritto T = tondo | Guarnizione esterna mm. | Guarnizioni interne vetro | | | | Vetrazione (spessore vetro in mm.) | | | | | | | | | | |
|-----------------------------|----------------------------|-----------------------------------------------|-----------------------------------------------------|-------------------------------|---------------------------|---------------|---------------|---------------|------------------------------------|------|------|------|------|------|------|------|--|--|--|
| | | | | | ARX.10.15 | ARX.10.14 | ARX.10.13 | ARX.10.12 | mm.10 | mm.9 | mm.8 | mm.7 | mm.6 | mm.5 | mm.4 | mm.3 | | | |
| 5 | 15 | 40 | T CX70.537 | 3 | | | | | 5 | 6 | 7 | 8 | 9 | | | | | | |
| 5 | 20 | 35 | D CX70.532 T CX70.531 | 3 | 7 | 8 | 9 | 10 | 11 | 12 | 13 | 14 | | | | | | | |
| 5 | 25 | 30 | D CX70.530 T CX70.525 | 3 | 12 | 13 | 14 | 15 | 16 | 17 | 18 | 19 | | | | | | | |
| 5 | 29 | 26 | D CX70.529 T CX70.524 | 3 | 16 | 17 | 18 | 19 | 20 | 21 | 22 | 23 | | | | | | | |
| 5 | 33 | 22 | D CX70.528 T CX70.523 | 3 | 20 | 21 | 22 | 23 | 24 | 25 | 26 | 27 | | | | | | | |
| 5 | 36 | 18 | D CX70.527 T CX70.522 | 3 | 24 | 25 | 26 | 27 | 28 | 29 | 30 | 31 | | | | | | | |
| 5 | 41 | 14 | D CX70.526 T CX70.521 | 3 | 28 | 29 | 30 | 31 | 32 | 33 | 34 | 35 | | | | | | | |
| 5 | 50 | 5 | D CX70.533 | 3 | 37 | 38 | 39 | 40 | 41 | 42 | 43 | 44 | | | | | | | |

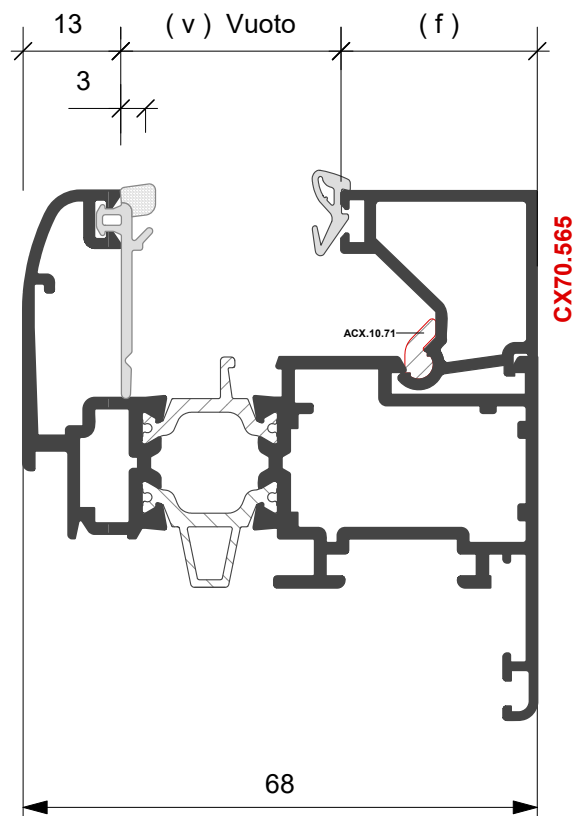
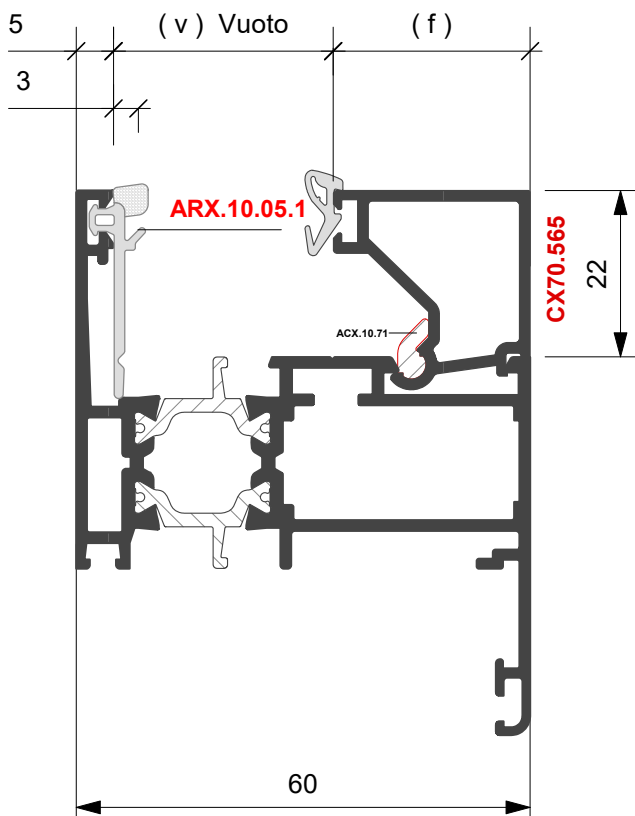



APPLICAZIONE TASSELLI VETRO PER TIPOLOGIA

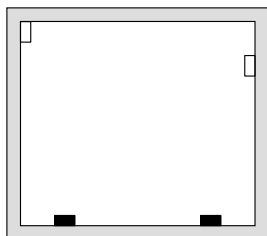

Telaio fisso

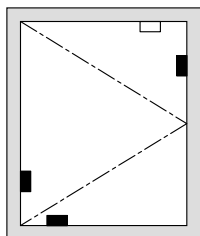

Anta a battente

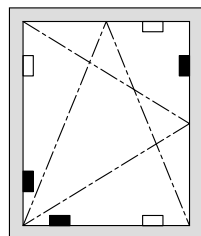

Anta ribalta

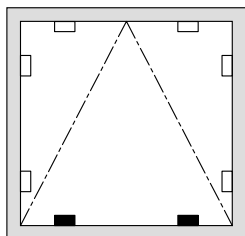
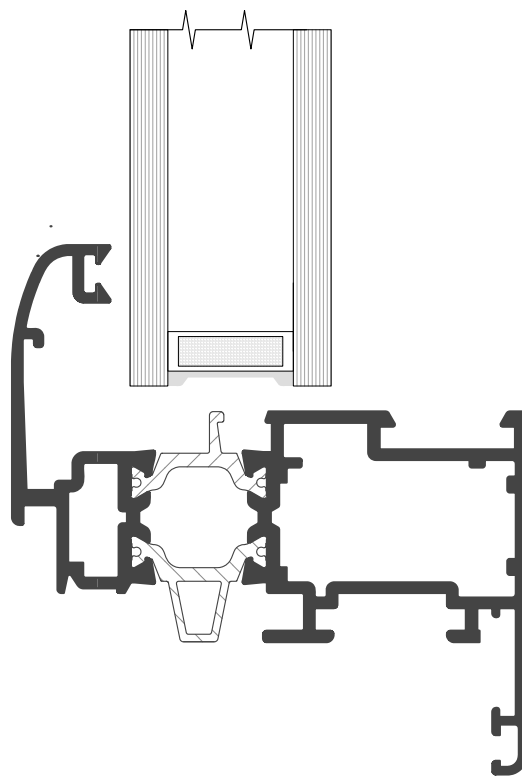

Wasistas

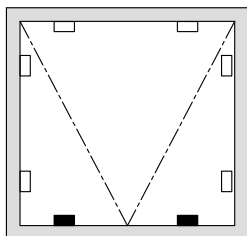

Sporgere

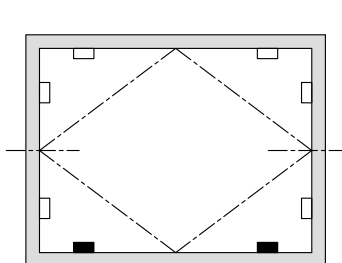

Bilico orizzontale

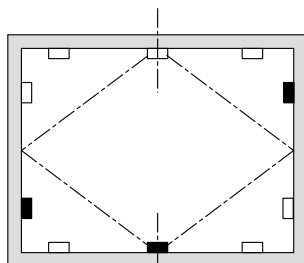

Bilico verticale

 Tassello di appoggio

 Tassello perimetrale





Codifica finiture superficiali accessori



















In fase di ordine aggiungere agli accessori di seguito riportati, ove previste, le seguenti codifiche superficiali :

| SIGLA | DESCRIZIONE |
|---------------|----------------------------|
| NEOPA | VERNICIATO NERO OPACO |
| R9010 | VERNICIATO BIANCO |
| R1013 | VERNICIATO AVORIO |
| R6005 | VERNICIATO VERDE |
| R9005 | VERNICIATO NERO LUCIDO |
| R8017 | VERNICIATO MARRONE |
| G6360 | VERNICIATO VERDE GOTICO |
| G9420 | VERNICIATO GRIGIO GOTICO |
| G3976 | VERNICIATO MARRONE GOTICO |
| VEARG | VERNICIATO ARGENTO |
| VSCRA | VERDE SCURO RAGGRINZITO |
| MARAG | MARRONE RAGGRINZITO |
| KANFU | CANNA DI FUCILE GOLDFINISH |
| KRAME | RAME GOLDFINISH |
| KINOX | INOX LUCIDO GOLDFINISH |
| KSATI | INOX SATINATO GOLDFINISH |
| KGOLD | GOLD GOLDFINISH |
| KANTIC | OTTONE ANTICO GOLDFINISH |
| ARGENT | NEW ARGENTO |
| BRONZ | NEW BRONZO |

Esempio :











ACX.02.01 - R9010 Cerniera verniciata bianco Ral 9010



| | | | |
|----------------------------------------------------------------------------------------------------------------------|-------------------------------------------------------------------------------------|-----------------------------------------------------------------------------------------------------------------|---------------------------------------------------------------------------------------|
| <p>ACX.01.SQ</p> <p>Descrizione Squadretta a pulsante (28.5 mm x 14.5 mm)</p> |  | <p>ACX.12.SQ</p> <p>Descrizione Cavallotto (28.5 mm x 14.5 mm)</p> |  |
| <p>ACX.02.SQ</p> <p>Descrizione Squad. cianfrinare/spinare/avvit. (28.5 mm x 14.5 mm)</p> |  | <p>ARX.13.SQ</p> <p>Descrizione Squadretta a pulsante (23.5 mm x 14.5 mm)</p> |  |
| <p>ARX.03.SQ</p> <p>Descrizione Squadretta cianfrinare/spinare (4.3 mm x 14 mm)</p> |  | <p>ACX.14.SQ</p> <p>Descrizione Squad. cianfrinare/spinare/avvit. (28.5 mm x 35.8 mm)</p> |  |
| <p>ACX.04.SQ</p> <p>Descrizione Squadretta a pulsante (28.5 mm x 35.8 mm)</p> |  | <p>ARX.15.SQ</p> <p>Descrizione Squadretta allineamento esterna tiraggio meccanico</p> |  |
| <p>ACX.05.SQ</p> <p>Descrizione Squadretta angolo variabile (28.5 mm x 14.5 mm)</p> |  | <p>ARX.18.SQ</p> <p>Descrizione Squadretta cianfrinare/spinare (4.3 mm x 26.3 mm)</p> |  |
| <p>ARX.06.SQ</p> <p>Descrizione Squadretta cianfrinare/spinare (4.3 mm x 39.1 mm)</p> |  | <p>ARX.24.SQ</p> <p>Descrizione Squad. allineamento esterna</p> |  |
| <p>ARX.07.SQ</p> <p>Spina per ACX.02.SQ e ACX.14.SQ</p> |  | <p>ACX.29.SQ</p> <p>Descrizione Cavallotto e vite (Prof. CX70.402)</p> |  |
| <p>ARX.08.SQ</p> <p>Spina per ACX.03.SQ e ACX.06.SQ</p> |  | | |
| <p>ARX.10.SQ</p> <p>Descrizione Squadretta allineamento interna</p> |  | <p>ARX.34.SQ</p> <p>Descrizione Squadretta per profilo scuretto RX450.427</p> |  |
| <p>ARX.11.SQ</p> <p>Descrizione Squadretta allineamento interna su profilo XX70.801 e RX60.109</p> |  | <p>ASX.24.SQ</p> <p>Descrizione Squadretta a pulsante (31.8 mm x 10.4 mm)</p> |  |



Cerniere

| | | | |
|--------------------------------------------------------------------------------------------------------------------------|-----------------------------------------------------------------------------------------------|---------------------------------------------------------------------------------------------------------------------------------|---------------------------------------------------------------------------------------|
| <p>ACX.35.SQ</p> <p>Descrizione</p> <p>Squadretta a pulsante</p> |  <p>SLIM</p> | <p>ACX.02.08</p> <p>Descrizione</p> <p>Braccio corto per vasistas (anta da mm. 280 a mm. 800)</p> |  |
| <p>ACX.36.SQ</p> <p>Descrizione</p> <p>Squadretta est. cianfrinare o con grano GRLM4x5ECP da ordinare a parte</p> |  <p>SLIM</p> | <p>ACX.02.09</p> <p>Descrizione</p> <p>Braccio telescopico per vasistas a scatto</p> |  |
| <p>ACX.02.01</p> <p>Descrizione</p> <p>Cerniera a montaggio rapido preassemblata a 2 ali</p> |  | <p>ACX.02.10</p> <p>Descrizione</p> <p>Cerniera a compasso</p> |  |
| <p>ACX.02.02</p> <p>Descrizione</p> <p>Cerniera a montaggio rapido preassemblata a 2 ali per 3°anta</p> |  | <p>ACX.02.10P</p> <p>Descrizione</p> <p>Cerniera cerniera scomparsa battente 40 kg, sporgere 120 kg, vasistat 120 kg</p> |  |
| <p>ACX.02.03</p> <p>Descrizione</p> <p>Cerniera a montaggio rapido preassemblata a 3 ali</p> |  | <p>ACX.02.11</p> <p>Descrizione</p> <p>Cerniera a 2 ali per porte con piastrina ad infilare</p> |  |
| <p>ACX.02.04</p> <p>Descrizione</p> <p>Cerniera a montaggio rapido preassemblata a 3 ali per 3°anta</p> |  | <p>ARX.02.12</p> <p>Descrizione</p> <p>Cerniera per porte esterna a 2 ali interasse 67 mm.</p> |  |
| <p>ACX.02.05</p> <p>Descrizione</p> <p>Cerniera per vasistas apertura singola 30°</p> |  | <p>ARX.02.13</p> <p>Descrizione</p> <p>Cerniera per porte esterna a 3 ali interasse 67 mm.</p> |  |
| <p>ACX.02.06</p> <p>Descrizione</p> <p>Cerniera per vasistas apertura doppia 30°/75°</p> |  | <p>ARX.02.14</p> <p>Descrizione</p> <p>Cerniera per porte esterna a 2 ali interasse 93 mm.</p> |  |
| <p>ACX.02.07</p> <p>Descrizione</p> <p>Braccio lungo per vasistas (anta da mm. 600 a mm. 1600)</p> |  | <p>ARX.02.15</p> <p>Descrizione</p> <p>Cerniera per porte esterna a 3 ali interasse 93 mm.</p> |  |



| | | | |
|------------------------------------------------------------------------------------------------|-------------------------------------------------------------------------------------------------|---------------------------------------------------------------------------------------------------|-------------------------------------------------------------------------------------------------|
| <p>ARX.02.16</p> <p>Descrizione</p> <p>Spessore mm.8 per cerniere esterne per porte</p> |  | <p>ACX.02.41</p> <p>Descrizione</p> <p>Cerniera montaggio rapido "TOP RAPID"</p> |  <p>SLIM</p> |
| <p>ARX.02.17</p> <p>Descrizione</p> <p>Cerniera per scuretto</p> |  | <p>ACX.03.01</p> <p>Descrizione</p> <p>Cricchetto in alluminio fissaggio con piastrine</p> |  |
| <p>ARX.02.21</p> <p>Descrizione</p> <p>Kit contropiastre cerniere a 2 ali</p> |  | <p>ARX.03.02</p> <p>Descrizione</p> <p>Maniglia a tavellino</p> |  |
| <p>ARX.02.22</p> <p>Descrizione</p> <p>Kit contropiastre cerniere a 3 ali</p> |  | <p>ARX.03.03</p> <p>Descrizione</p> <p>Maniglia doppia</p> |  |
| <p>ARX.02.23</p> <p>Descrizione</p> <p>Perni fissaggio cerniere da 68 mm.</p> |  | <p>ASX.03.03</p> <p>Descrizione</p> <p>Martellina doppia COMFORT</p> |  |
| <p>ARX.02.24</p> <p>Descrizione</p> <p>Viti di fissaggio cerniere</p> |  | <p>ARX.03.04</p> <p>Descrizione</p> <p>Martellina Sporgenza quadro mm.24</p> |  |
| <p>ARX.02.25</p> <p>Descrizione</p> <p>Kit gradino</p> |  | <p>ARX.03.05</p> <p>Descrizione</p> <p>Martellina con chiave Sporgenza quadro mm.24</p> |  |
| <p>ARX.02.37</p> <p>Descrizione</p> <p>Regolatore in altezza per cerniere ARX.02.11</p> |  | <p>ARX.03.05LDX</p> <p>Descrizione</p> <p>Martellina LOGICA dx Sporgenza quadro mm.24</p> |  |
| <p>ACX.02.40</p> <p>Descrizione</p> <p>Cerniera montaggio rapido "TOP RAPID"</p> |  <p>SLIM</p> | <p>ARX.03.05LSX</p> <p>Descrizione</p> <p>Martellina LOGICA sx Sporgenza quadro mm.24</p> |  |



















| | | | |
|-----------------------------------------------------------------------------------------------------------|-------------------------------------------------------------------------------------|-----------------------------------------------------------------------------------------------------------------------|---------------------------------------------------------------------------------------|
| <p>ARX.03.06</p> <p>Descrizione</p> <p>Cremonese Interasse 84 - 92 - 104</p> |  | <p>ACX.03.14</p> <p>Descrizione</p> <p>Incontro asta doppio</p> |  |
| <p>ARX.03.07</p> <p>Descrizione</p> <p>Cremonese con chiave Interasse 84 - 92 - 104</p> |  | <p>ACX.03.15</p> <p>Descrizione</p> <p>Ferma anta</p> |  |
| <p>ARX.03.07LDX</p> <p>Descrizione</p> <p>Cremonese LOGICA dx Interasse 84 - 92 - 104</p> |  | <p>ACX.03.16</p> <p>Descrizione</p> <p>Perno di chiusura supplementare regolabile</p> |  |
| <p>ARX.03.07LSX</p> <p>Descrizione</p> <p>Cremonese LOGICA sx Interasse 84 - 92 - 104</p> |  | <p>ACX.03.17</p> <p>Descrizione</p> <p>Innesti cremonese</p> |  |
| <p>ARX.03.08</p> <p>Descrizione</p> <p>Cremonese per Anta Ribalta</p> |  | <p>ACX.03.18</p> <p>Descrizione</p> <p>Terminali astina</p> |  |
| <p>ARX.03.09</p> <p>Descrizione</p> <p>Movimentazione Bidirezionale Interasse da 15-27 mm.</p> |  | <p>ACX.03.19</p> <p>Descrizione</p> <p>Sostegno anta</p> |  |
| <p>ACX.03.10</p> <p>Descrizione</p> <p>Movimentazione Unidirezionale per Anta Ribalta</p> |  | <p>ARX.03.22</p> <p>Descrizione</p> <p>Fast Out chiusura apert. esterna L=1000 mm.(3 punti) E = 35mm.</p> |  |
| <p>ACX.03.11</p> <p>Descrizione</p> <p>Catenacciolo a leva</p> |  | <p>ARX.03.23</p> <p>Descrizione</p> <p>Fast Out chiusura apert. esterna L=600 mm.(2 punti) E = 35mm.</p> | |
| <p>ACX.03.12</p> <p>Descrizione</p> <p>Terminale asta</p> |  | <p>ARX.03.24</p> <p>Descrizione</p> <p>Fast Out chiusura apert. esterna L=1600 mm.(3 punti) E = 35mm.</p> | |





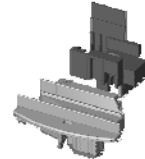

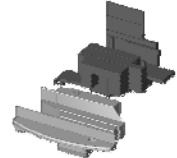



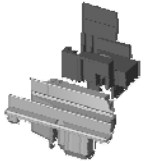

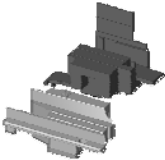

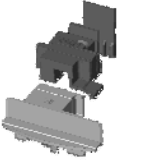

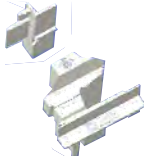



| | | | |
|-------------------------------------------------------------------------------------------------------|-------------------------------------------------------------------------------------|------------------------------------------------------------------------------------------------------------------------------|---------------------------------------------------------------------------------------|
| <p>ACX.03.25</p> <p>Descrizione</p> <p>Kit Fast Out chiusura apert. esterna art. ARX.03.22</p> |  | <p>ARX.03.48</p> <p>Descrizione</p> <p>Cremonese apertura esterna con chiave</p> |  |
| <p>ACX.03.26</p> <p>Descrizione</p> <p>Kit Fast Out chiusura apert. esterna art. ACX.03.23</p> |  | <p>ARX.03.50</p> <p>Descrizione</p> <p>Cremonese apertura esterna con chiave</p> |  |
| <p>ACX.03.27</p> <p>Descrizione</p> <p>Kit Fast Out chiusura apert. esterna art. ACX.03.24</p> | | <p>ACX.03.52</p> <p>Descrizione</p> <p>Braccio chiusura antieffrazione</p> |  |
| <p>ARX.03.28</p> <p>Descrizione</p> <p>Martellina Sporgenza quadro mm.64 per Fast Out</p> |  | <p>ACX.03.53</p> <p>Descrizione</p> <p>Martellina Italia Sporgenza quadro 24 mm, con scatto per microventilazione</p> |  |
| <p>ACX.03.29</p> <p>Descrizione</p> <p>Rostro chiusura supplementare</p> |  | <p>ACX.03.54</p> <p>Descrizione</p> <p>Sirio terminale asta con puntale in ottone ø 6 mm, decentrato dx</p> |  |
| <p>ARX.03.30</p> <p>Descrizione</p> <p>Tavellino per profilo scuretto RX450.427</p> |  | <p>ACX.03.55</p> <p>Descrizione</p> <p>Sirio terminale asta con puntale in ottone ø 6 mm, decentrato sx</p> |  |
| <p>ACX.03.43</p> <p>Descrizione</p> <p>Astina in poliammide</p> |  | <p>ACX.03.56</p> <p>Descrizione</p> <p>Sirio terminale asta con puntale in ottone ø 8 mm</p> |  |
| <p>ARX.03.45</p> <p>Descrizione</p> <p>Perno trascinamento L=22 mm.</p> |  | <p>ACX.03.57</p> <p>Descrizione</p> <p>Cremonese ITALIA int. 84,5 - 104 mm.</p> |  |
| <p>ARX.03.46</p> <p>Descrizione</p> <p>Cremonese con chiave</p> |  | <p>ACX.03.58</p> <p>Descrizione</p> <p>Kit base accessori per chiusura antieffrazione</p> |  |

















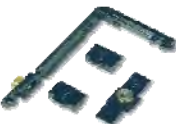

| | | | |
|--------------------------------------------------------------------------------------------------------------------------------------|-------------------------------------------------------------------------------------|-----------------------------------------------------------------------------------------------------------------------------------------------|--------------------------------------------------------------------------------------------------|
| <p>ACX.03.59</p> <p>Descrizione</p> <p>Cremonese ITALIA per AR con anti falsa manovra su cremonese</p> |  | <p>ACX.03.68</p> <p>Descrizione</p> <p>Doppia maniglia "Comfort mini"</p> |  |
| <p>ACX.03.60</p> <p>Descrizione</p> <p>Punto chiusura antieffrazione lavorazione astina tonda diam. 8</p> |  | <p>ACX.03.69</p> <p>Descrizione</p> <p>Doppia maniglia "ITALIA"</p> |  |
| <p>ACX.03.61</p> <p>Descrizione</p> <p>Chiusura antieffrazione sistema di sicurezza per connessione astina</p> |  | <p>ACX.03.70</p> <p>Descrizione</p> <p>Catenaccio a comando diretto Sirio</p> |  |
| <p>ACX.03.62</p> <p>Descrizione</p> <p>Incontro a pozzetto per puntale ø 6 mm</p> |  | <p>ACX.03.71</p> <p>Descrizione</p> <p>Catenaccio a leva "Mini tex"</p> |  <p>SLIM</p> |
| <p>ACX.03.63</p> <p>Descrizione</p> <p>Incontro a pozzetto per puntale ø 6 mm</p> |  | <p>ACX.03.72</p> <p>Descrizione</p> <p>Movimentazione Bidirezionale Interasse da 23-35 mm.</p> |  |
| <p>ACX.03.64</p> <p>Descrizione</p> <p>Corpo di manovra a leva "Mini tex"</p> |  | <p>ACX.03.73</p> <p>Descrizione</p> <p>"COMFORT MINI" Martellina ridotta Sporgenza quadro mm.70</p> |  |
| <p>ACX.03.65</p> <p>Descrizione</p> <p>Catenaccio a leva bidirezionale "bi-hid" kit</p> |  | <p>ACX.03.74</p> <p>Descrizione</p> <p>"COMFORT MINI" Martellina ridotta con cilindro Sporgenza quadro mm.70</p> |  |
| <p>ACX.03.66</p> <p>Descrizione</p> <p>Perno di trascinamento L=11 mm</p> |  | <p>ACX.04.01HP</p> <p>Descrizione</p> <p>Tappo riporto Giunto Aperto Profilo riporto tondo</p> |  |
| <p>ACX.03.67</p> <p>Descrizione</p> <p>Perno di trascinamento L=27 mm</p> |  | <p>ARX.04.02HP</p> <p>Descrizione</p> <p>Tappo riporto G. A. ferr. nastro Profilo riporto tondo</p> |  |





















| | | | |
|-----------------------------------------------------------------------------------------------------------------|------------------------------------------------------------------------------------------------|------------------------------------------------------------------------------------|---------------------------------------------------------------------------------------|
| <p>ACX.04.03HP</p> <p>Descrizione</p> <p>Tappo riporto Giunto Aperto Profilo riporto dritto</p> |  | <p>ARX.06.02</p> <p>Descrizione</p> <p>Piastrina Registro Universale</p> |  |
| <p>ARX.04.04HP</p> <p>Descrizione</p> <p>Tappo riporto G. A. ferr. nastro Profilo riporto dritto</p> |  | <p>ARX.06.03</p> <p>Descrizione</p> <p>Grano per registro ARX.06.02</p> |  |
| <p>ACX.04.07</p> <p>Descrizione</p> <p>Tappo doppia battuta</p> |  | <p>ACX.06.04</p> <p>Descrizione</p> <p>Registro Z/P</p> |  |
| <p>ACX.04.34</p> <p>Descrizione</p> <p>Tappo riporto T - Z</p> |  <p>SLIM</p> | <p>ARX.06.08</p> <p>Descrizione</p> <p>Regolo mobile da mm.15</p> |  |
| <p>ARX.04.20</p> <p>Descrizione</p> <p>Giunto taglio a 90° vetro infilare</p> |  | <p>ARX.06.09</p> <p>Descrizione</p> <p>Regolo mobile da mm. 20</p> |  |
| <p>ARX.04.30</p> <p>Descrizione</p> <p>Tappo a L battuta inferiore porte</p> |  | <p>ARX.06.10</p> <p>Descrizione</p> <p>Regolo mobile da mm. 30</p> |  |
| <p>ARX.04.31</p> <p>Descrizione</p> <p>Tappo diritto battuta inf. porte</p> |  | <p>ARX.06.11</p> <p>Descrizione</p> <p>Regolo mobile da mm. 45</p> |  |
| <p>ARX.05.01</p> <p>Descrizione</p> <p>Cappetta drenaggio acqua</p> |  | <p>ACX.07.02</p> <p>Descrizione</p> <p>Angolo Universale fermavetro</p> |  |
| <p>ARX.06.01</p> <p>Descrizione</p> <p>Registro Universale</p> |  | <p>ACX.07.08</p> <p>Descrizione</p> <p>Clip per fermavetri tondi</p> |  |











| | | | |
|-----------------------------------------------------------------------------------------------------------------------------------------------------------|---------------------------------------------------------------------------------------|--------------------------------------------------------------------------------------------------------------------------|---------------------------------------------------------------------------------------|
| <p>ACX.08.01</p> <p>Descrizione</p> <p>Anta Ribalta WEEN Kit base con anti falsa manovra sulla cremonese portata 160 Kg.</p> |  | <p>ACX.08.16</p> <p>Descrizione</p> <p>Perno chiusura supplementare</p> |  |
| <p>ARX.08.01L</p> <p>Descrizione</p> <p>Anta Ribalta WEEN Kit base con anti falsa manovra sulla cremonese portata 160 Kg.</p> <p>Logica</p> |  | <p>ACX.08.18</p> <p>Descrizione</p> <p>Chiusura supplementare inferiore orizzontale</p> |  |
| <p>ACX.08.05</p> <p>Descrizione</p> <p>A. R. Braccio Supplementare</p> |  | <p>ACX.08.19</p> <p>Descrizione</p> <p>Dispositivo microventilazione regolabile</p> |  |
| <p>ACX.08.05L</p> <p>Descrizione</p> <p>A. R. Braccio Supplementare</p> <p>Logica</p> |  | <p>ACX.08.22</p> <p>Descrizione</p> <p>Anta Ribalta Braccio Corto da 395 mm. a 450 mm.</p> |  |
| <p>ACX.08.06</p> <p>Descrizione</p> <p>Chiusura Supplementare verticale e universale</p> |  | <p>ACX.08.22L</p> <p>Descrizione</p> <p>Anta Ribalta Braccio Corto da 395 mm. a 450 mm.</p> <p>Logica</p> |  |
| <p>ACX.08.09</p> <p>Descrizione</p> <p>A. R. Cerniere a pettine 2.0</p> |  | <p>ACX.08.23</p> <p>Descrizione</p> <p>Anta Ribalta Braccio Medio da 451 mm. a 650 mm.</p> |  |
| <p>ACX.08.13</p> <p>Descrizione</p> <p>Incontro asta singolo</p> |  | <p>ACX.08.23L</p> <p>Descrizione</p> <p>Anta Ribalta Braccio Medio da 451 mm. a 650 mm.</p> <p>Logica</p> |  |
| <p>ACX.08.24</p> <p>Descrizione</p> <p>Anta Ribalta Braccio Lungo da 651 mm. a 1700 mm.</p> |  | <p>ACX.08.24L</p> <p>Descrizione</p> <p>Anta Ribalta Braccio Lungo da 651 mm. a 1700 mm.</p> <p>Logica</p> |  |



| | | | |
|---------------------------------------------------------------------------------------------------------------------------------------------------------|----------------------------------------------------------------------------------------------------------|---------------------------------------------------------------------------------------------------------------------------------------------------------------------------|------------------------------------------------------------------------------------------------------------|
| <p>ACX.08.25</p> <p>Descrizione Kit cerniera a pettine regol. Portata 120 Kg.</p> |  | <p>ACX.08.34</p> <p>Descrizione Ween hide 180 braccio medio AR scomparsa - sx solo per ante CX70.260HP e CX70.261HP</p> |  <p>Logica</p> |
| <p>ACX.08.26</p> <p>Descrizione Cerniere vasistas a scomparsa solo per ante CX70.260HP e CX70.261HP</p> |  | <p>ACX.08.35</p> <p>Descrizione Ween hide 180 supporto anta per portata 170 kg. ante CX70.260HP e CX70.261HP</p> |  |
| <p>ACX.08.27</p> <p>Descrizione Ween hide 180 braccio corto AR a scomparsa - dx solo per ante CX70.260HP e CX70.261HP</p> |  | <p>ACX.08.36</p> <p>Descrizione Ween hide 180 cerniera superiore scomparsa - dx ante CX70.260HP e CX70.261HP</p> |  |
| <p>ACX.08.28</p> <p>Descrizione Ween hide 180 braccio corto AR a scomparsa - sx solo per ante CX70.260HP e CX70.261HP</p> |  | <p>ACX.08.37</p> <p>Descrizione Ween hide 180 cerniera superiore scomparsa - sx ante CX70.260HP e CX70.261HP</p> |  |
| <p>ACX.08.29</p> <p>Descrizione Ween hide 180 braccio corto AR a scomparsa - dx solo per ante CX70.260HP e CX70.261HP</p> |  <p>Logica</p> | <p>ACX.08.38</p> <p>Descrizione Ween hide 180 cerniera sup.a scomparsa per anta battente(dx) ante CX70.260HP e CX70.261HP</p> |  |
| <p>ACX.08.30</p> <p>Descrizione Ween hide 180 braccio corto AR a scomparsa - sx solo per ante CX70.260HP e CX70.261HP</p> |  <p>Logica</p> | <p>ACX.08.39</p> <p>Descrizione Ween hide 180 cerniera sup.a scomparsa per anta battente(sx) ante CX70.260HP e CX70.261HP</p> |  |
| <p>ACX.08.31</p> <p>Descrizione Ween hide 180 braccio medio AR scomparsa - dx solo per ante CX70.260HP e CX70.261HP</p> |  | <p>ACX.08.40</p> <p>Descrizione Ween hide 180 kit base anta ribalta con anti falsa manovra sulla cremonese ante CX70.260HP e CX70.261HP</p> |  |
| <p>ACX.08.32</p> <p>Descrizione Ween hide 180 braccio medio AR scomparsa - sx solo per ante CX70.260HP e CX70.261HP</p> |  | <p>ACX.08.41</p> <p>Descrizione Ween hide 180 kit base anta ribalta con anti falsa manovra sulla cremonese ante CX70.260HP e CX70.261HP</p> |  <p>Logica</p> |
| <p>ACX.08.33</p> <p>Descrizione Ween hide 180 braccio medio AR scomparsa - dx solo per ante CX70.260HP e CX70.261HP</p> |  <p>Logica</p> | <p>ACX.08.42</p> <p>Descrizione Martellina ITALIA sporgenza quadro 24 mm, con scatto microventilazione</p> |  |



| | | |
|-------------------------------------------------------------------------------------------------------------------------------------|-------------------------------------------------------------------------------------|--|
| <p>ACX.08.43</p> <p>Descrizione</p> <p>Anta ribalta "ween wi-cloud ar" automatica port.max 160 kg</p> |  | |
| <p>ACX.08.44</p> <p>Descrizione</p> <p>Catenaccio a leva ad appoggio per anta affiancata Ween</p> |  | |
| <p>ARX.09.01</p> <p>Descrizione</p> <p>Attrezzatura Pneumatica</p> |  | |
| <p>ARX.09.02</p> <p>Descrizione</p> <p>KIT FRESE</p> |  | |
| <p>ACX.20.01</p> <p>Descrizione</p> <p>WI-CLOUD RC Attuatore a catena radiocomandato</p> |  | |
| <p>ARX.20.02</p> <p>Descrizione</p> <p>WI-CONTROL Radiocomando</p> |  | |
| <p>ACX.20.03</p> <p>Descrizione</p> <p>WI-CLOUD Attuatore a catena radiocomandato</p> |  | |
| <p>ACX.20.04</p> <p>Descrizione</p> <p>WI-CLOUD RC-LOCK Attuatore a catena con serratura elettromeccanica</p> |  | |
| | | |

Guarnizioni

| | | | |
|-----------------------------------------------------------------------------------------------------------------|--|-----------------------------------------------------------------------------------------|--|
| ARX.10.01 Descrizione Guarnizione Centrale di Precamera | | ARX.10.09 Descrizione Canalina isolante per ferramenta a nastro | |
| ARX.10.02 Descrizione Angolo per guarnizione centrale di Precamera art. ARX.10.01 | | ARX.10.10 Descrizione Spazzola a pavimento | |
| ACX.10.03 Descrizione Guarnizione di battuta a scatto | | ARX.10.12 Descrizione Guarnizione vetro interna spessore 3 - 4 mm. | |
| ACX.10.04 Descrizione Guarnizione di battuta ad infilo | | ARX.10.13 Descrizione Guarnizione vetro interna spessore 5 - 6 mm. | |
| ARX.10.05 Descrizione Guarnizione vetro esterna per isolamento termico-acustico | | ARX.10.14 Descrizione Guarnizione vetro interna spessore 7 - 8 mm. | |
| ARX.10.05.1 Descrizione Guarnizione vetro esterna coestrusa per isolamento termico-acustico | | ARX.10.15 Descrizione Guarnizione vetro interna spessore 9 - 10 mm. | |
| ARX.10.06 Descrizione Guarnizione sotto vetro per isolamento termico-acustico | | ARX.10.16 Descrizione Guarnizione perimetrale | |
| ARX.10.07 Descrizione Guarnizione di battuta esterna acustica esterna mm.1 | | ARX.10.27 Descrizione Rotella infila guarnizioni | |
| ARX.10.08 Descrizione Guarnizione di battuta per ferramenta a nastro | | ASX.10.35 Descrizione Guarnizione rigida per porte | |
| ACX.10.71 Descrizione Articolo per fermavetro di sicurezza (a pezzi) | | | |

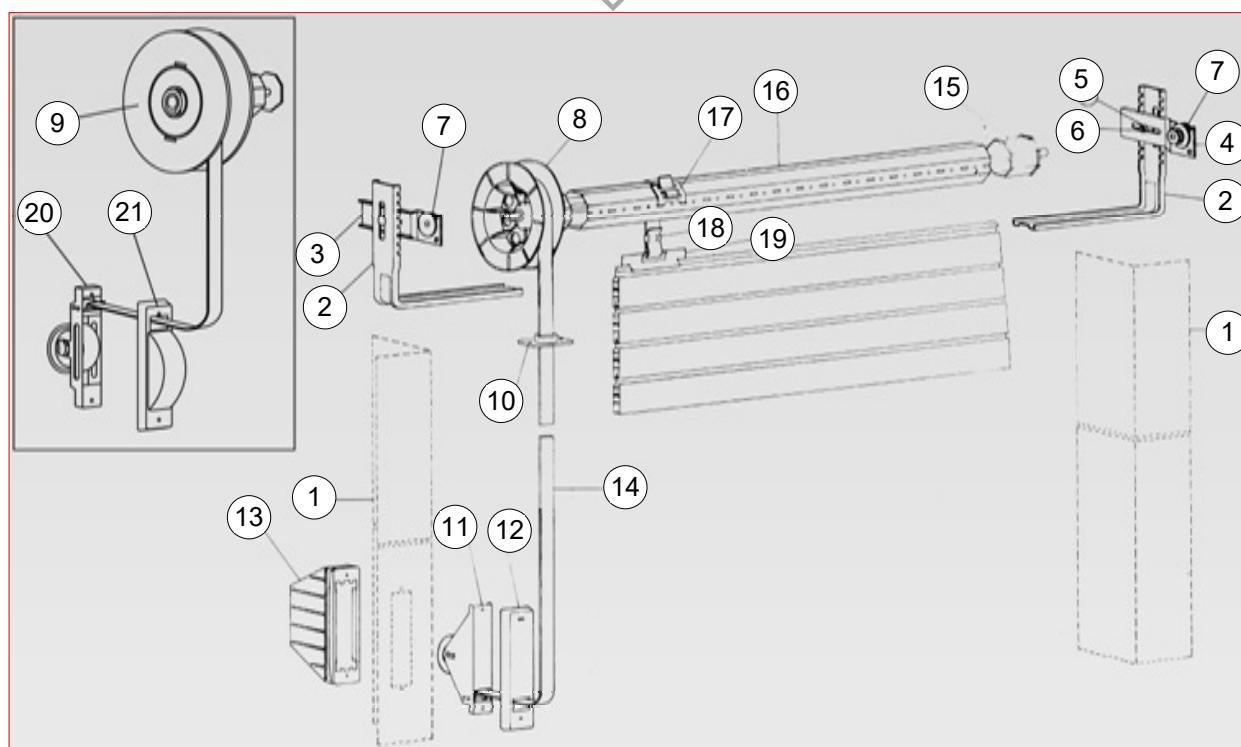

| | |
|-------------------------------------------------------------------------------------|-----------------------------------------------------------------------------------|
| <p>ARX.10.28</p> |  |
| <p>Descrizione Guarnizione vetro esterna coestrusa spessore 1.5 mm.</p> | |
| <p>ARX.10.29</p> |  |
| <p>Descrizione Guarnizione vetro esterna coestrusa spessore 1.5 mm.</p> | |
| <p>ARX.10.30</p> |  |
| <p>Descrizione Guarnizione vetro esterna Dutral spessore 3 mm.</p> | |

Monoblocco - Soluzione con puleggia

| | | | | |
|------------------|----------------------------------------------|-----|------------------|-------|
| ARX.11.01 | Supporto a squadro A = mm 46 | 2 | | 2 |
| ARX.11.02 | Mensola per supporto (SIN) | 1 | | 3 |
| ARX.11.03 | Mensola per supporto (DX) | 1 | | 4 |
| ARX.11.04 | Vite 6 x 20 con dado | 2 | | 5 - 6 |
| ARX.11.05 | Boccola in nylon | 2 | | 7 |
| ARX.11.06 | Puleggia in plastica a minimo ingombro Ø 220 | 1 | scegliere tipo | 8 |
| ARX.11.07 | Guida cinghia trasversale in nylon | 1 | scegliere colore | 10 |
| ARX.11.08 | Avvolgitore | 1 | | 11 |
| ARX.11.09 | Placca | 1 | scegliere tipo | 12 |
| ARX.11.10 | Cassetta | 1 | scegliere tipo | 13 |
| ARX.11.11 | Cintino | Mt. | scegliere tipo | 14 |
| ARX.11.12 | Calotta in plastica | 1 | | 15 |
| ARX.11.13 | Rullo ottagonale | Mt. | scegliere tipo | 16 |
| ARX.11.14 | Gancio per attacco cintino al rullo | 2 | | 17 |
| ARX.11.15 | Grappa fermacintino | 2 | | 18 |
| ARX.11.16 | Gancio per avvolgibili in plastica con asola | 2 | | 19 |

Monoblocco - Soluzione con puleggia

| | | | | |
|------------------|-------------------------------------------------|---|----------------|----|
| ARX.11.18 | Riduttore portata 40 kg. R=1:2,6 Puleggia Ø 220 | 1 | | 9 |
| ARX.11.19 | Avvolgitore | 1 | | 20 |
| ARX.11.20 | Placca | 1 | scegliere tipo | 21 |

Vari

| | |
|------------------|----------------------------------------------------|
| ARX.11.21 | Invito tapparella in nylon su profilo in alluminio |
| ARX.11.22 | Coppia tappi laterali cassonetto in alluminio |



Sezioni

Gruppo **D**

Sezioni principali
in scala 1:1
corredate dei relativi accessori



SCHEMA DIMENSIONALE

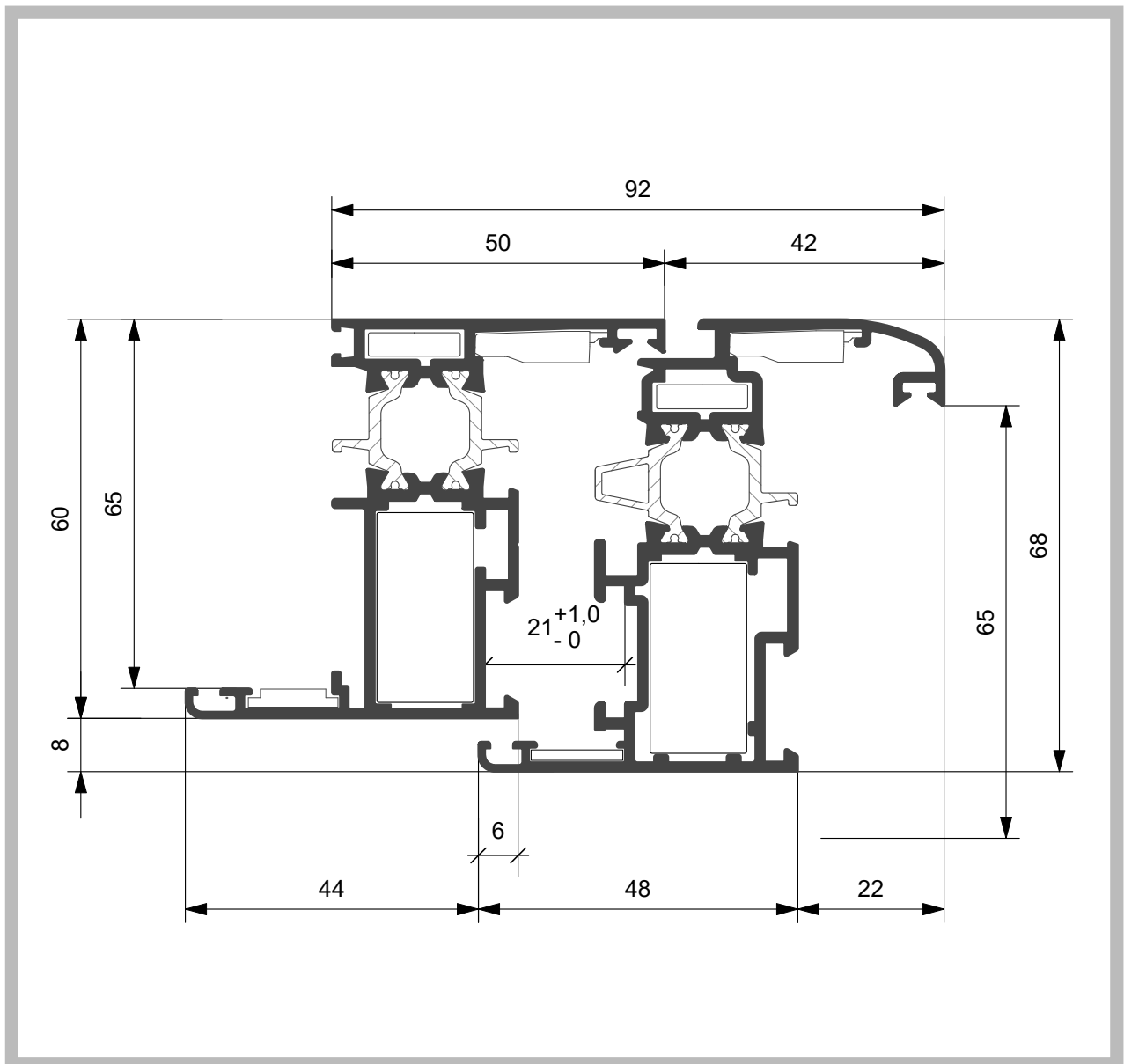



FINESTRA A DUE ANTE

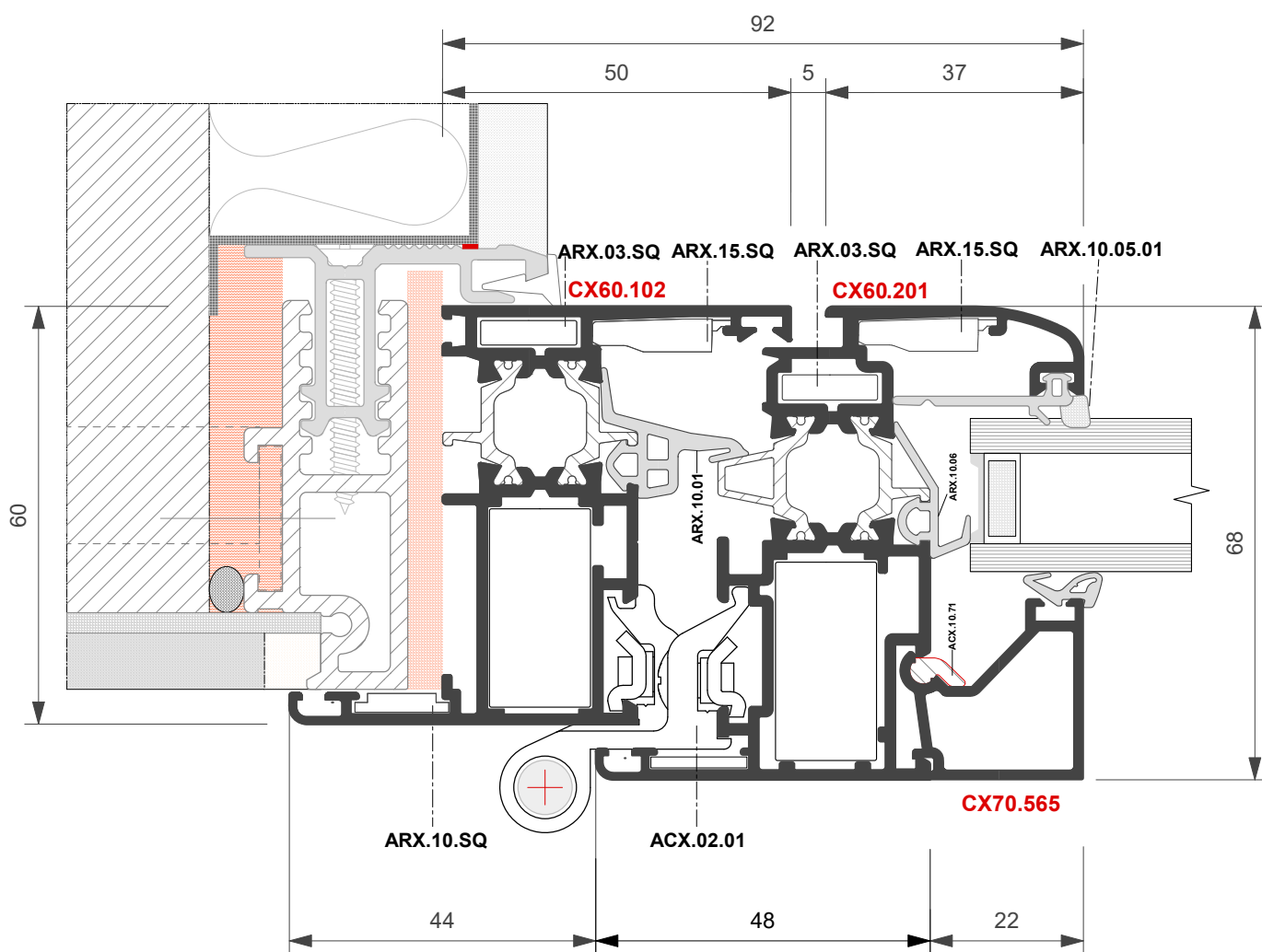
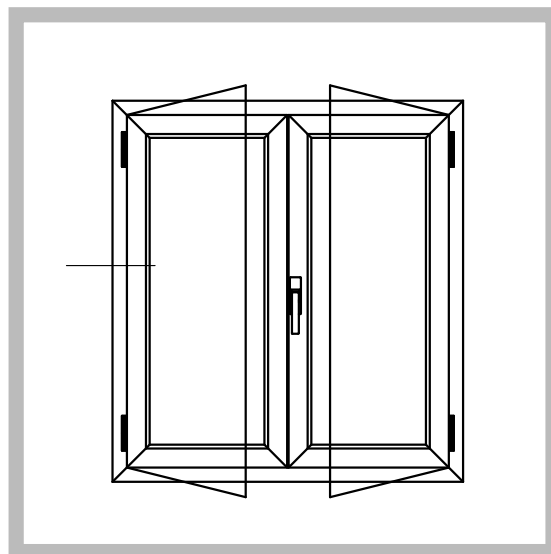



FINESTRA A DUE ANTE

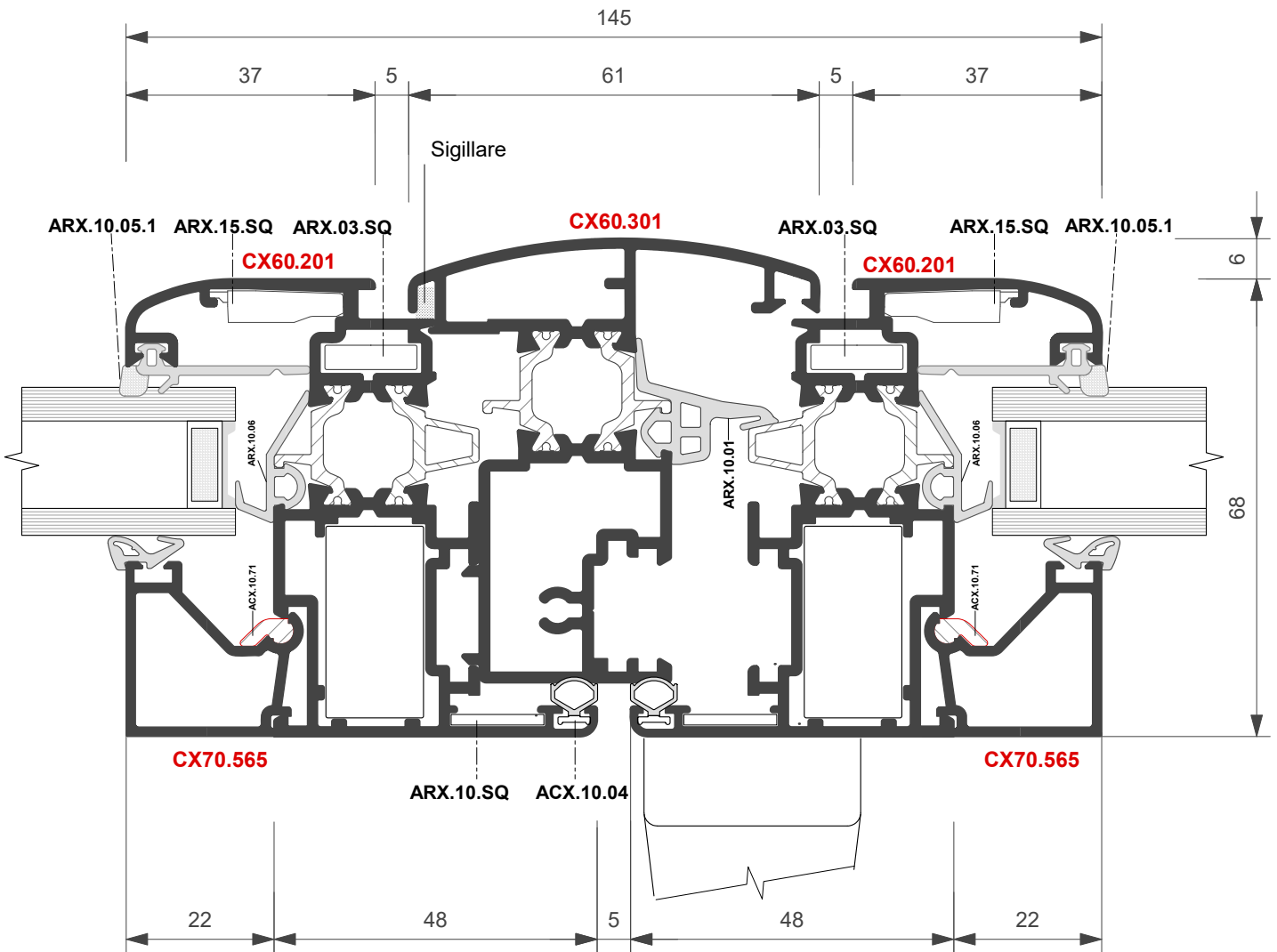
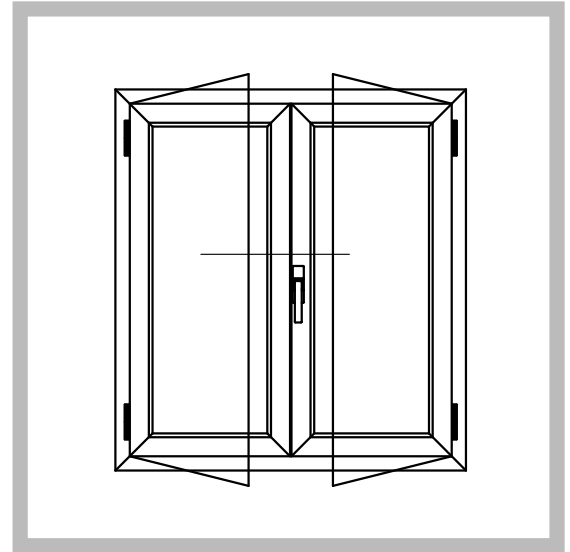



FINESTRA A DUE ANTE

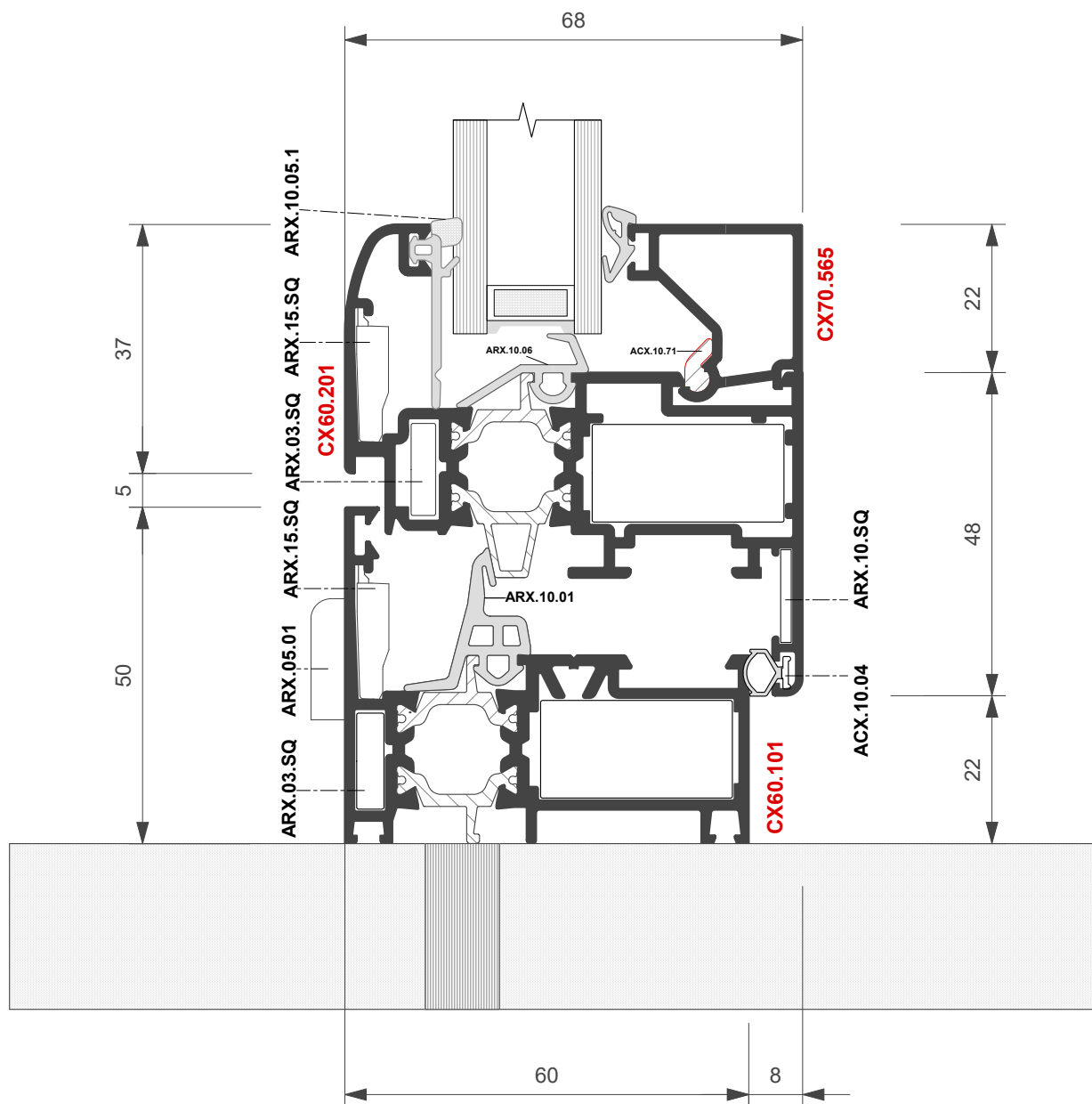
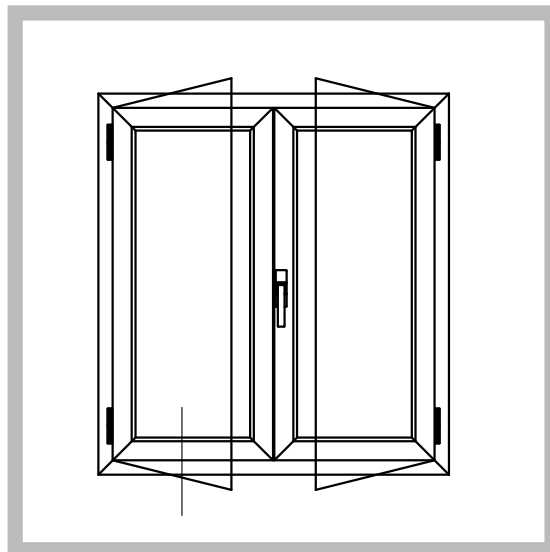



PORTA BALCONE A DUE ANTE

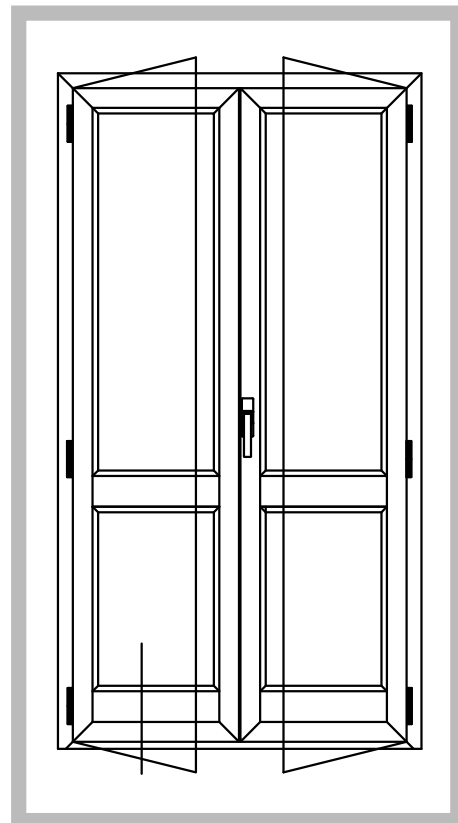
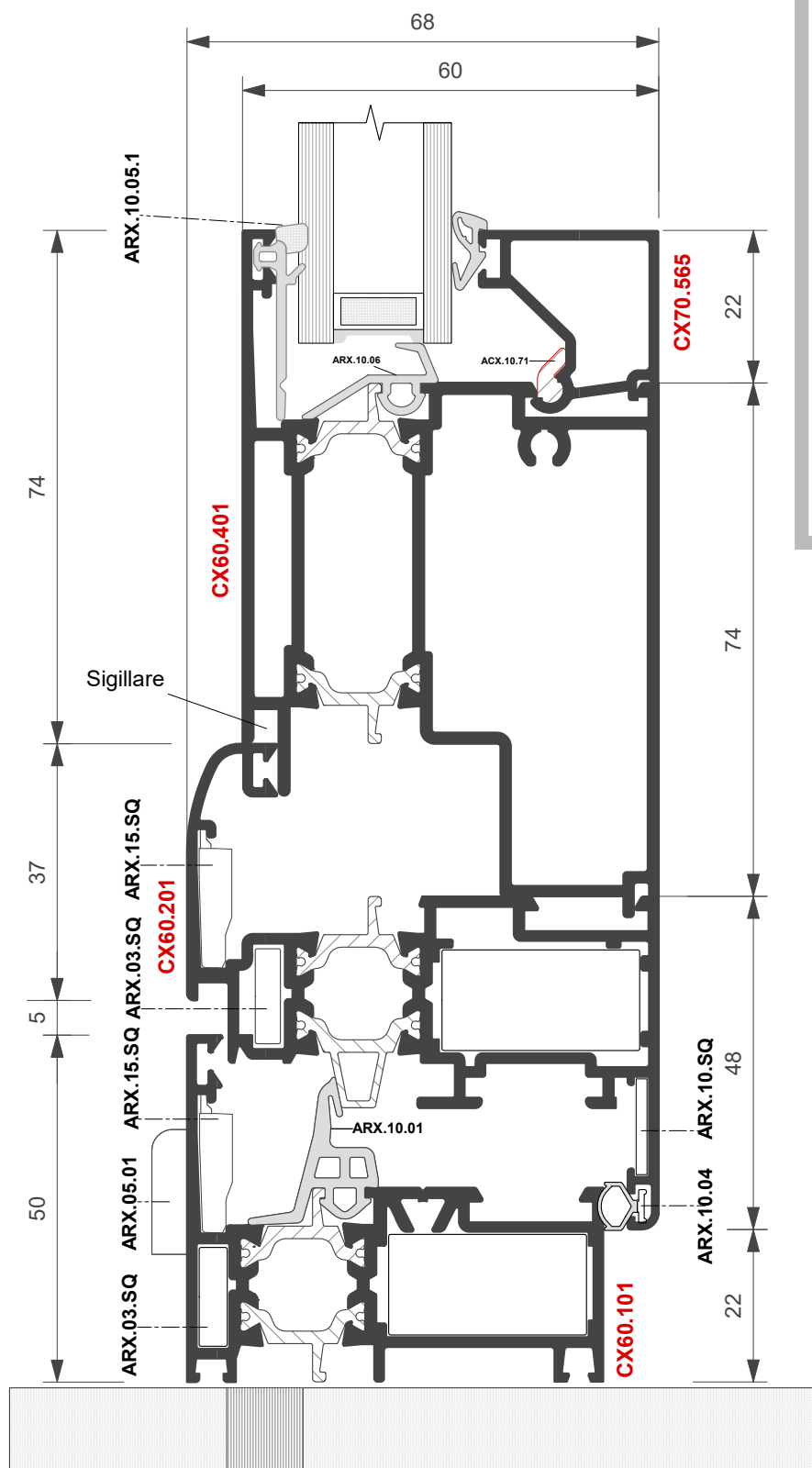



**PORTA BALCONE A DUE ANTE
con soglia bassa**

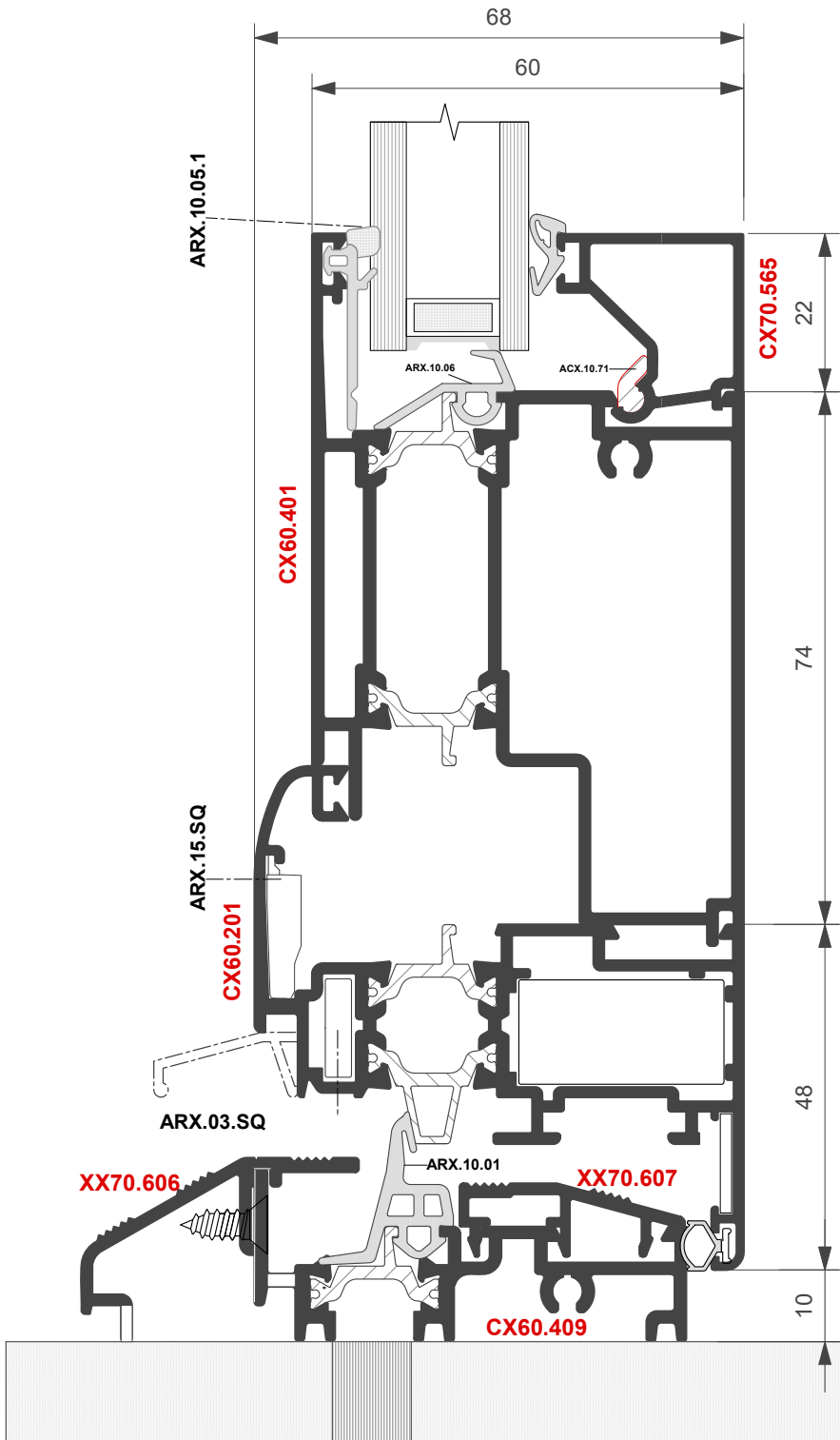
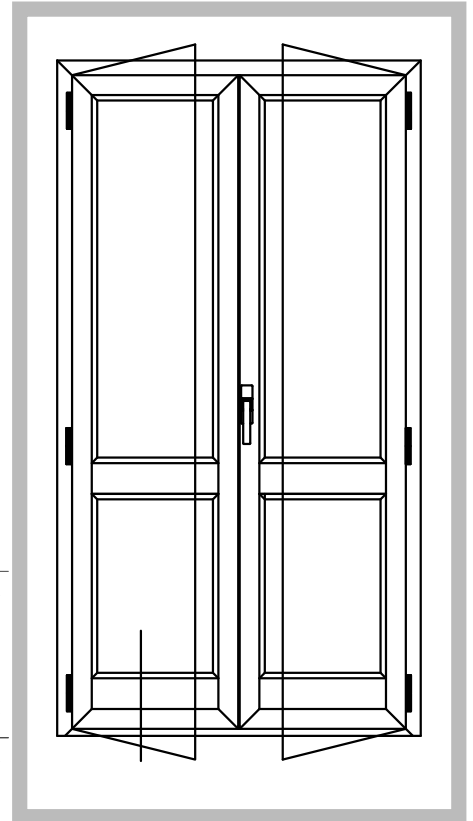



PORTA BALCONE A DUE ANTE

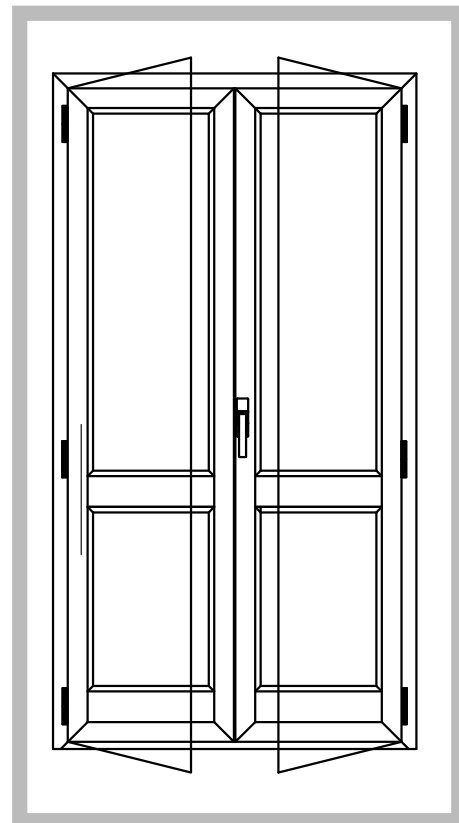
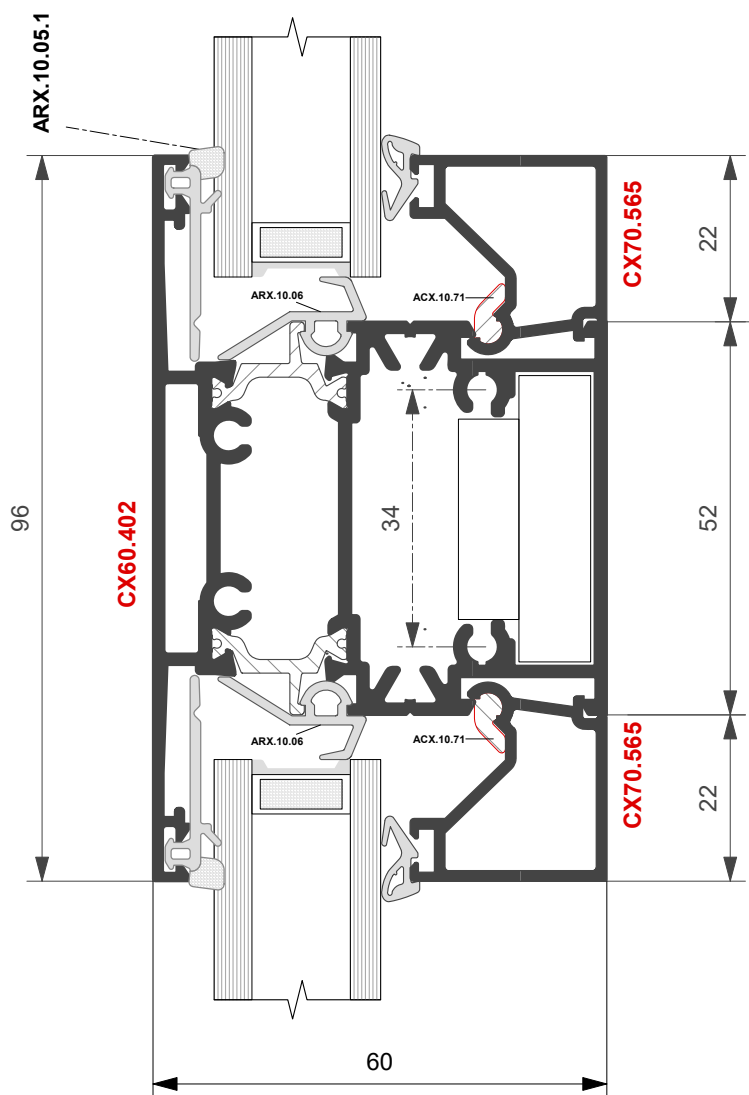



FINESTRA A DUE ANTE

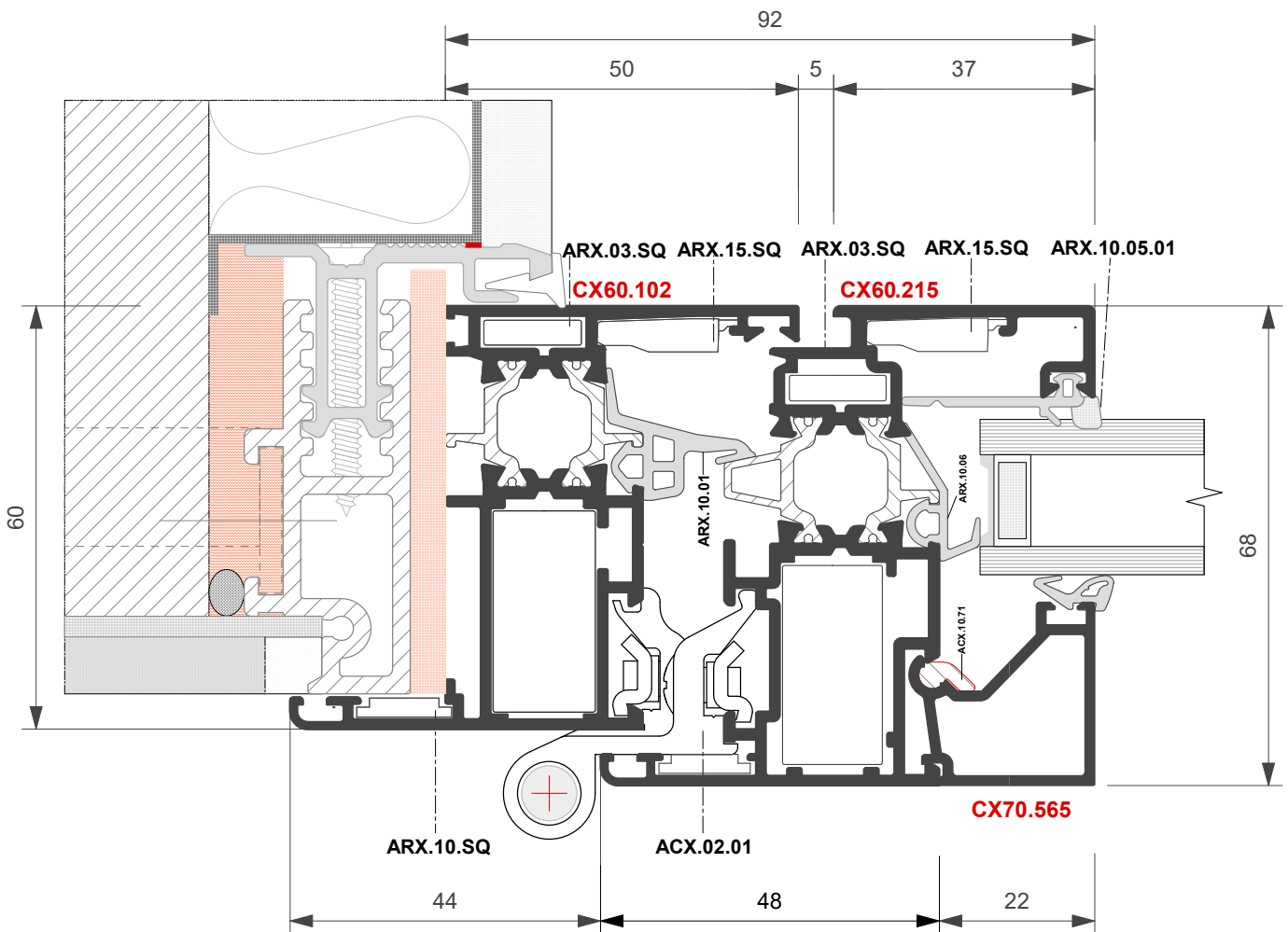
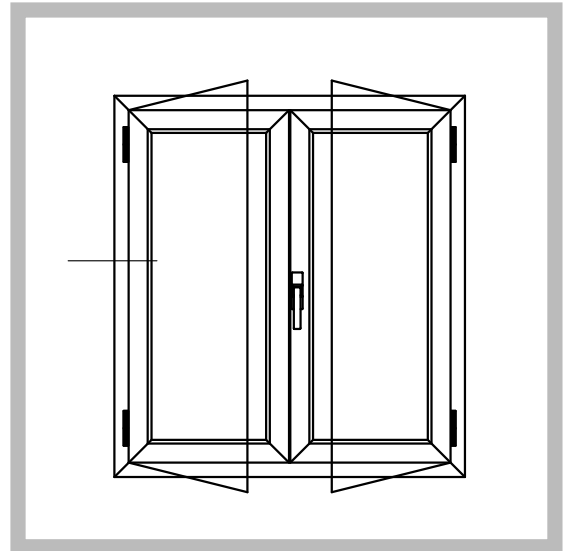



FINESTRA A DUE ANTE

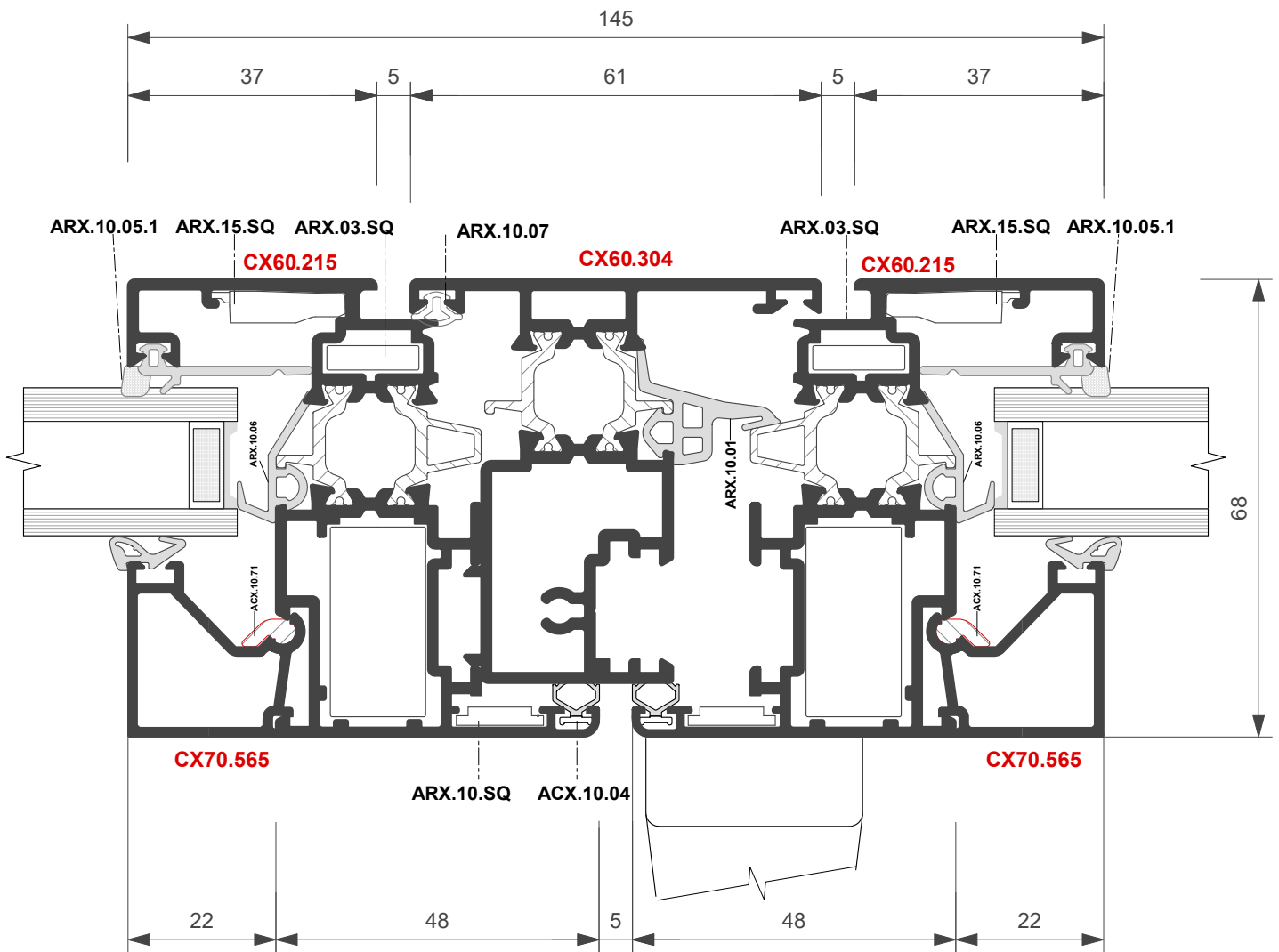
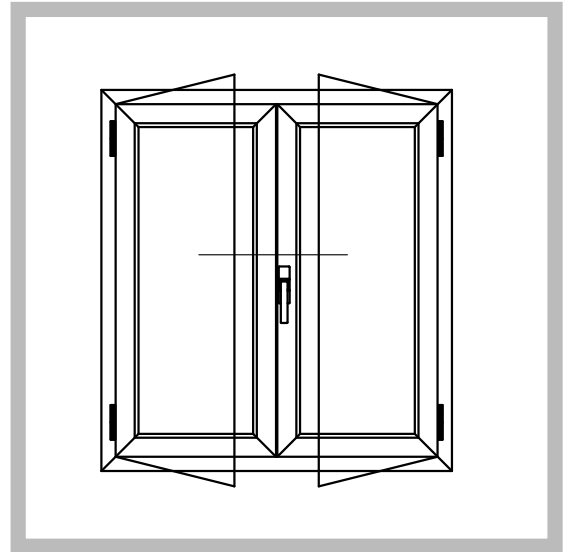



FINESTRA A DUE ANTE

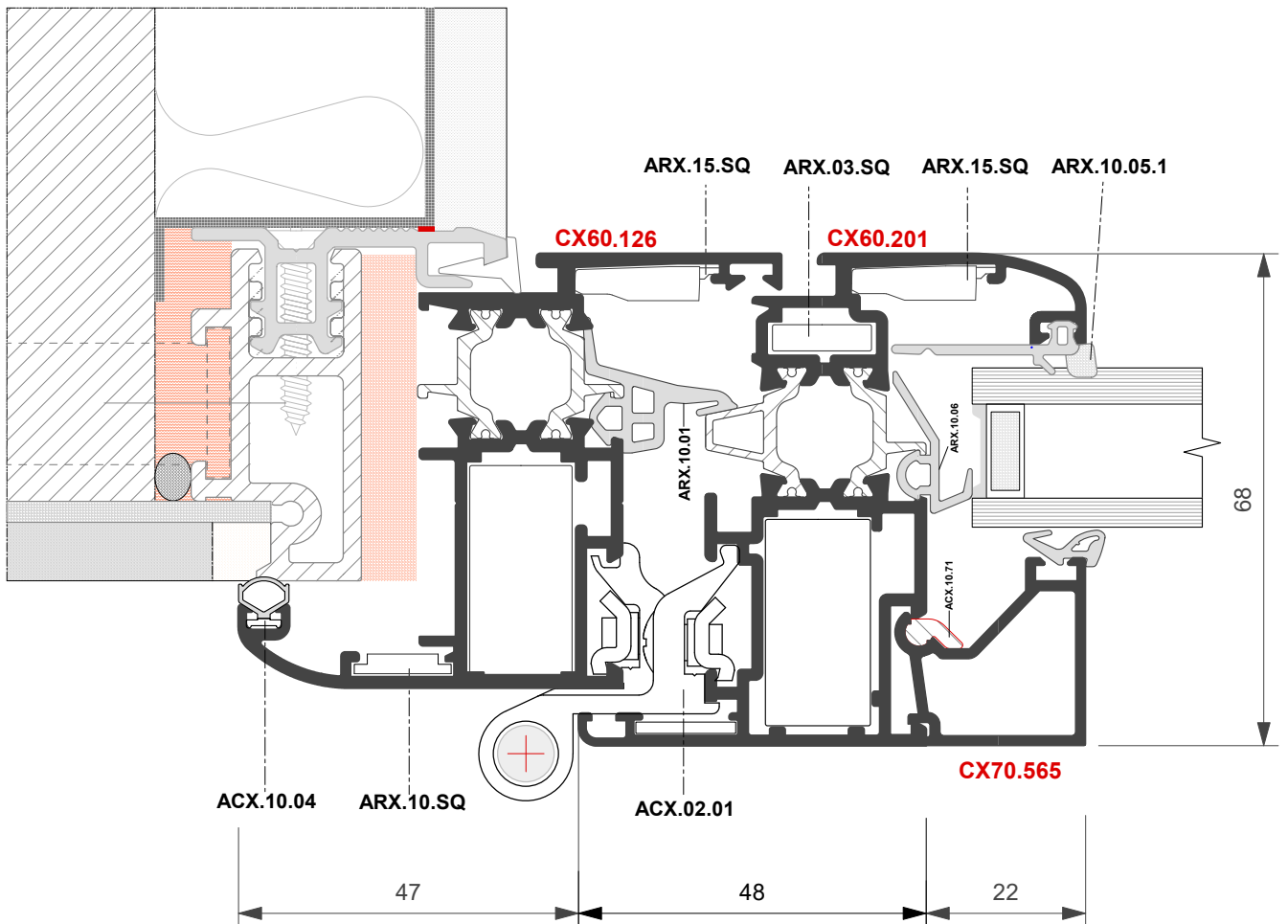
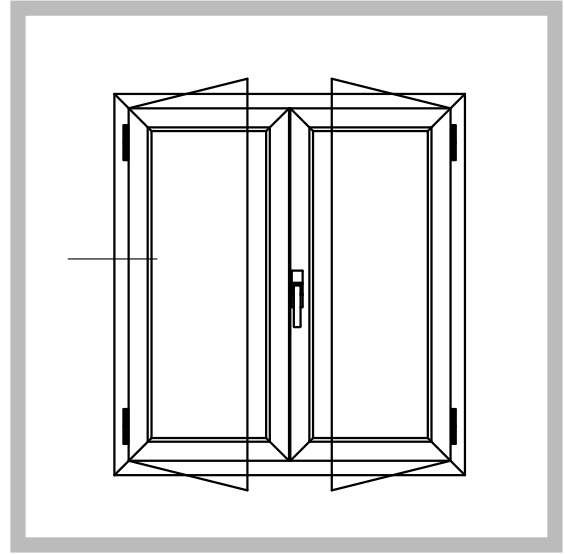



FINESTRA A DUE ANTE
Vetro ad infilare

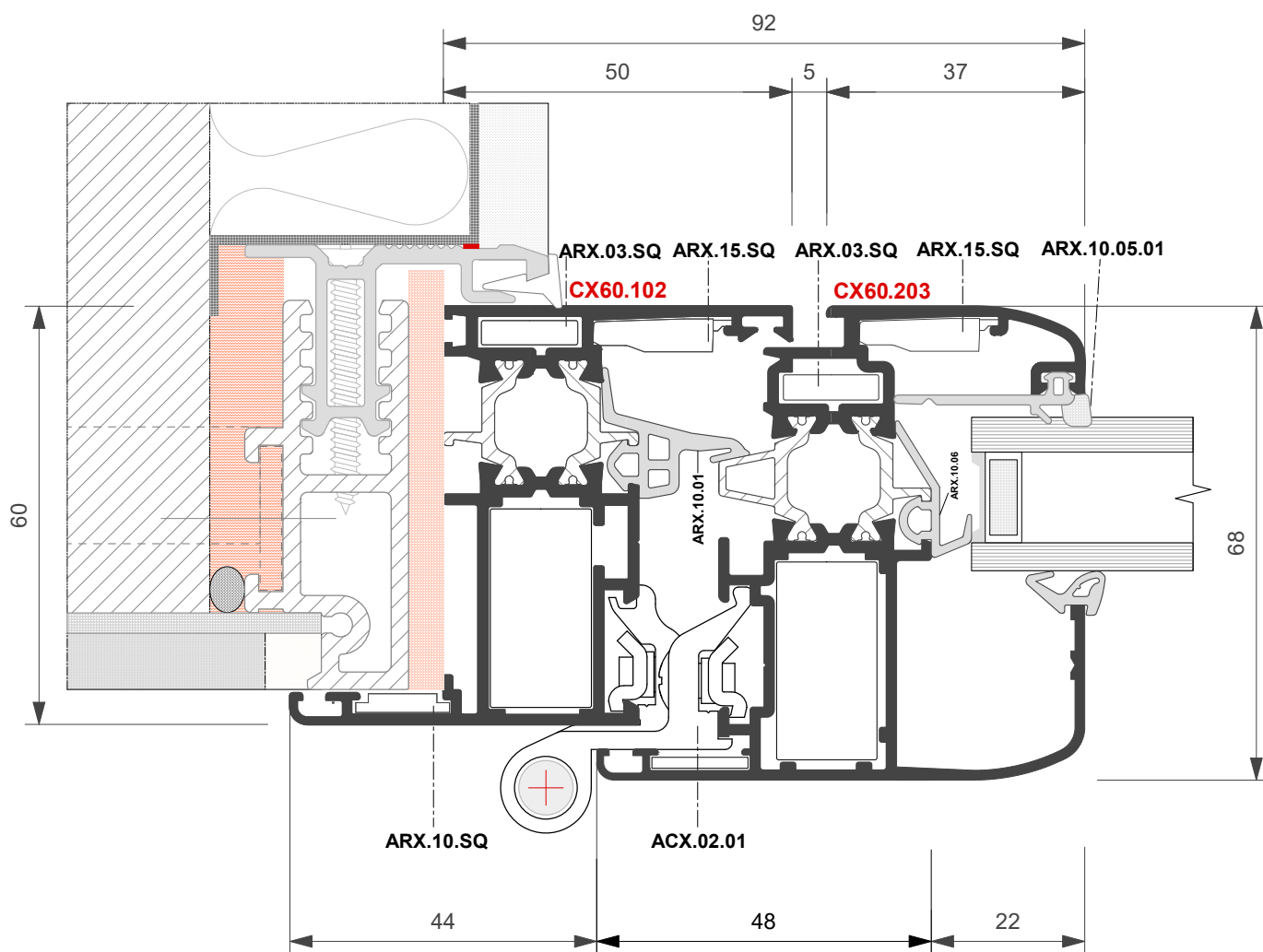
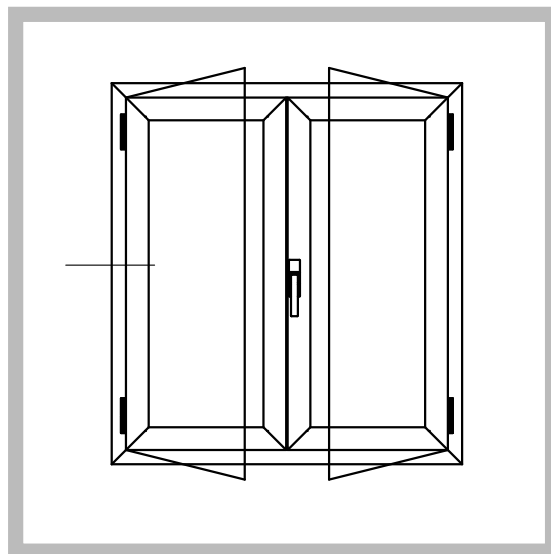



FINESTRA A DUE ANTE
Vetro ad infilare

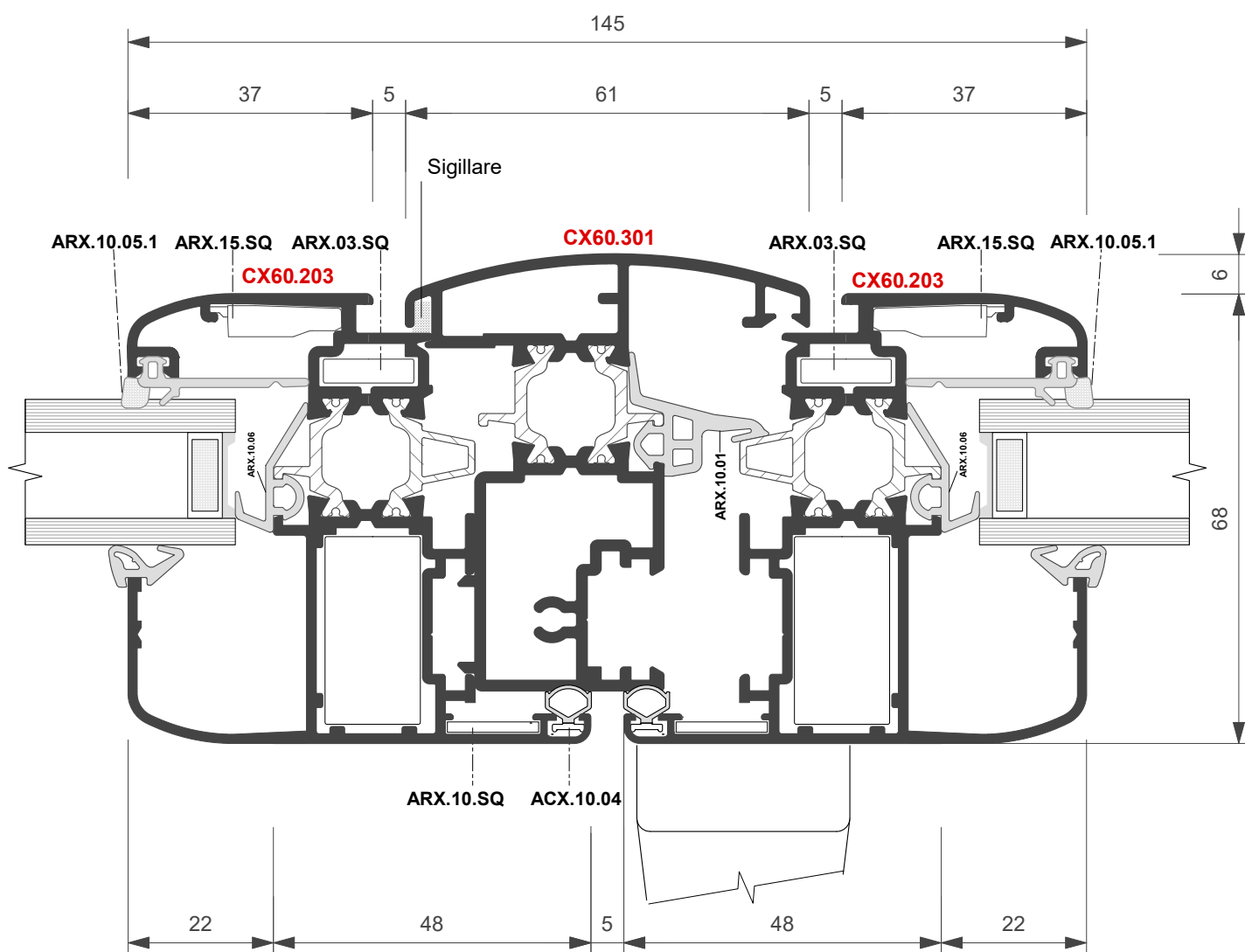
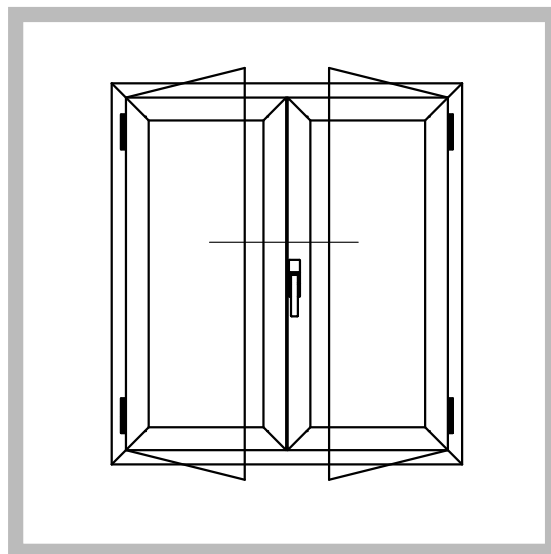



PORTA BALCONE A DUE ANTE
Vetro ad infilare

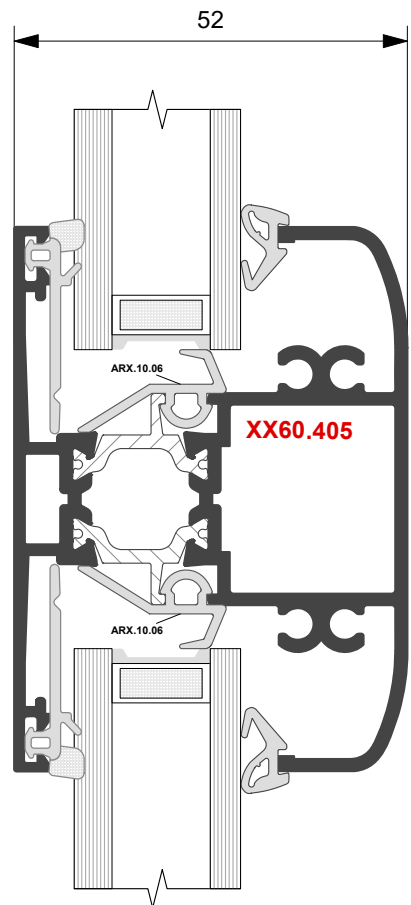
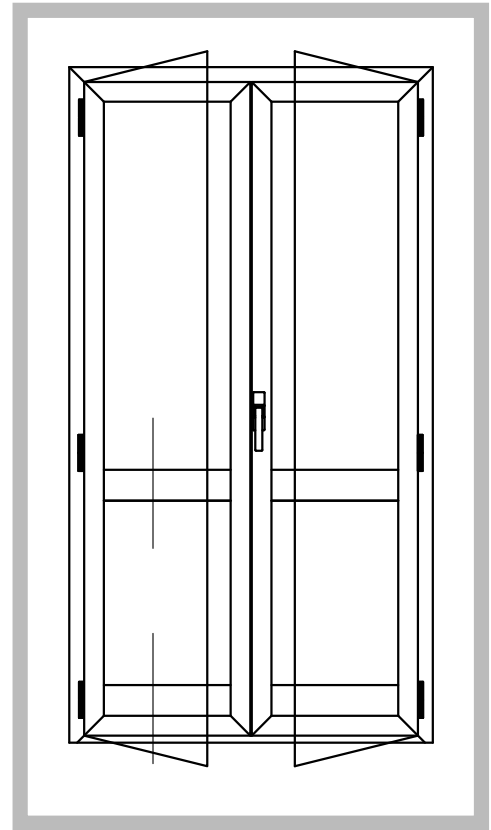
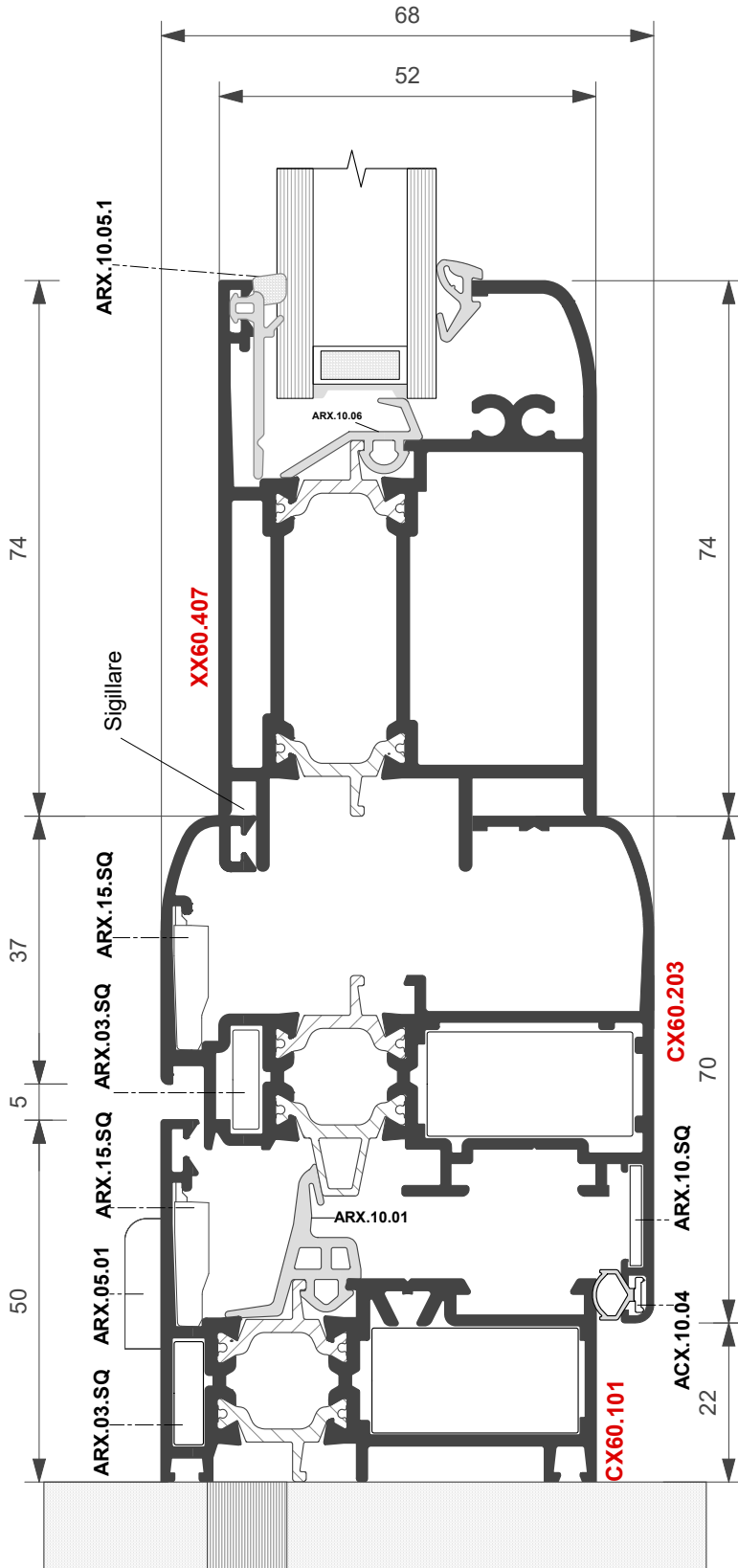



FINESTRA A DUE ANTE
Vetro ad infilare

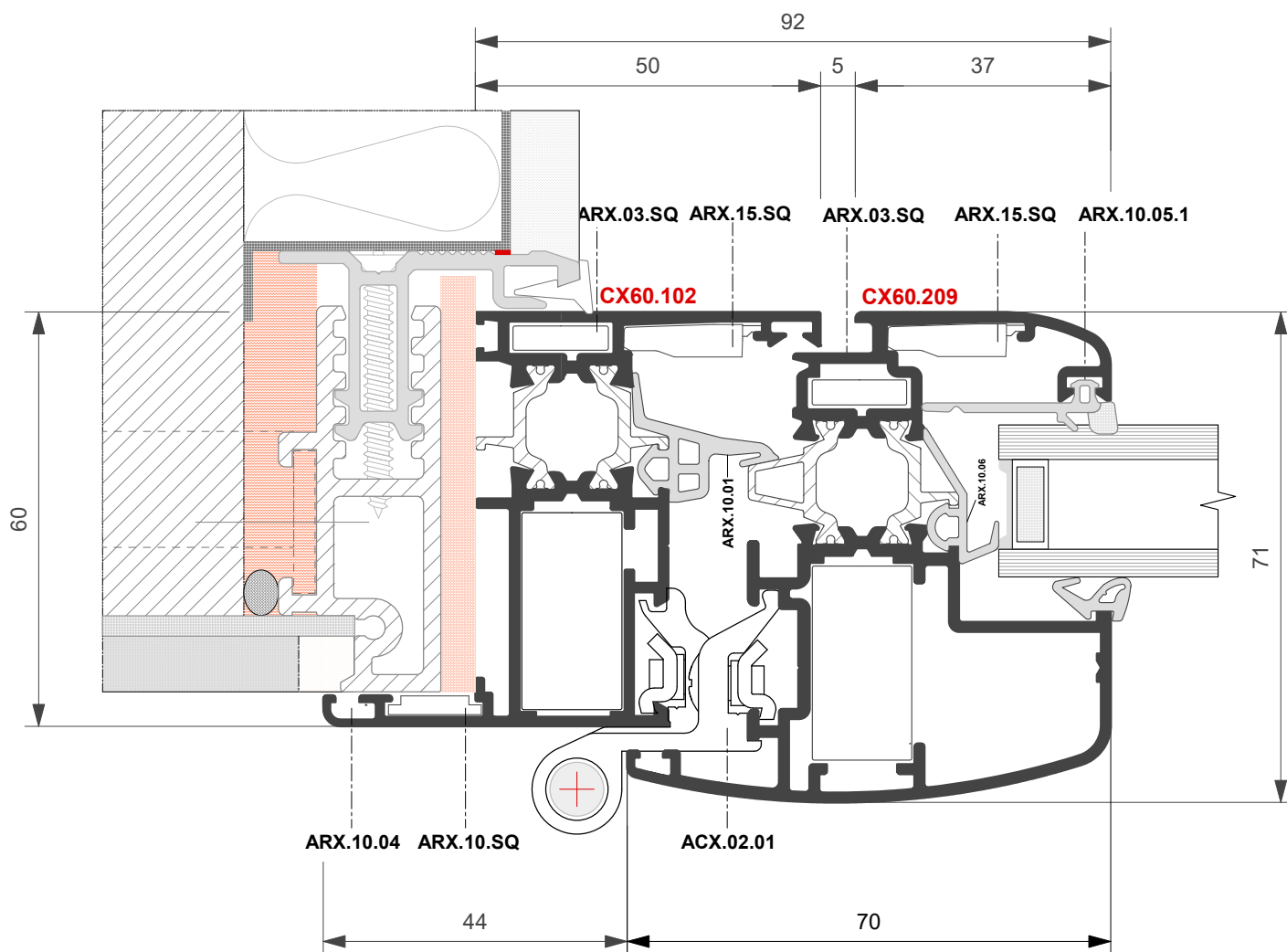
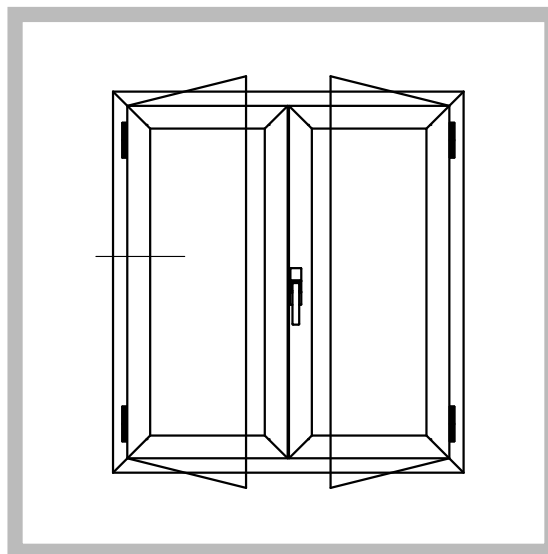



FINESTRA A DUE ANTE
Vetro ad infilare

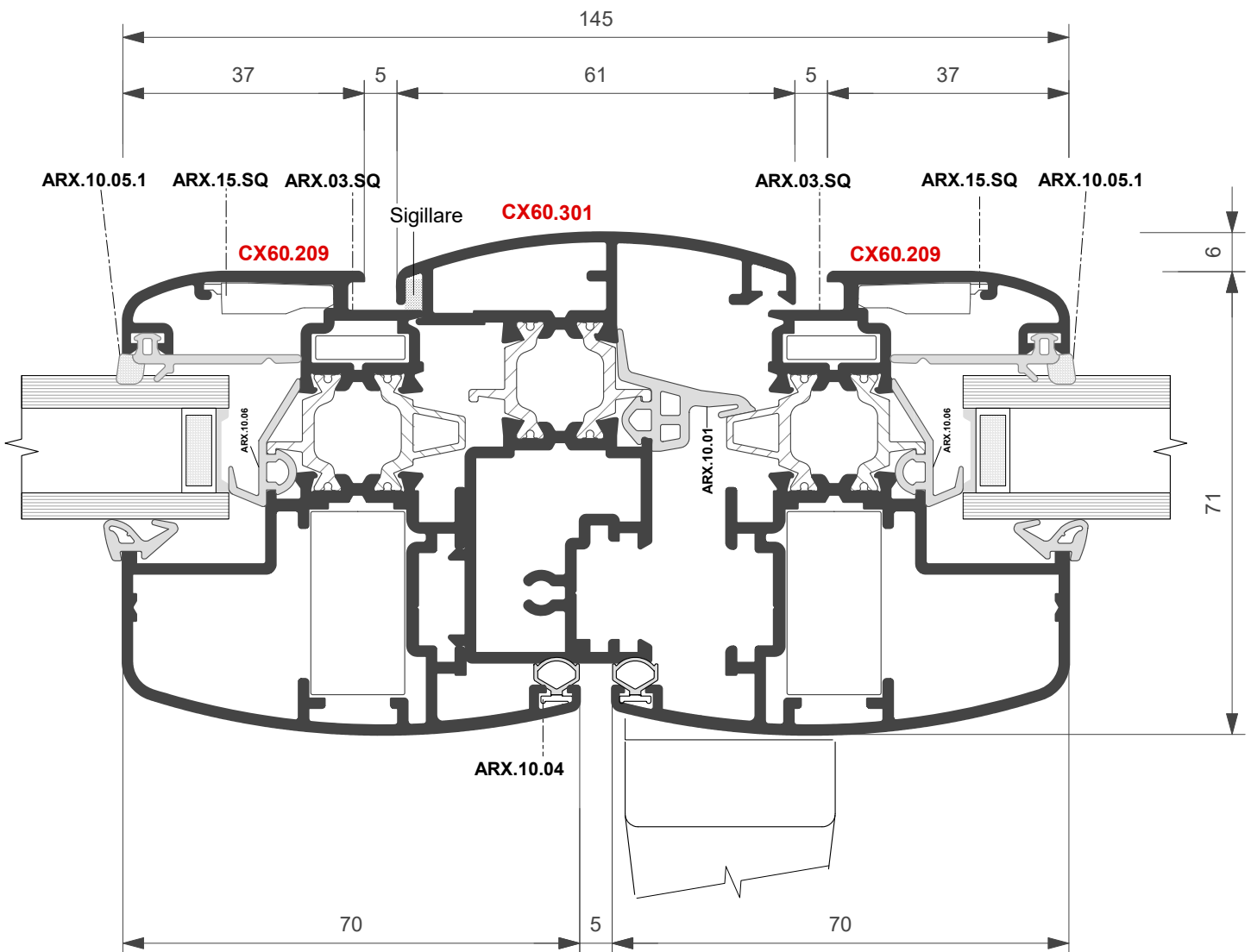
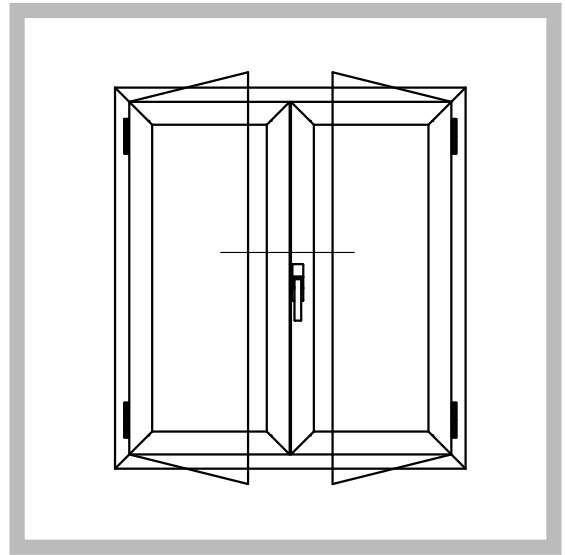



FINESTRA A DUE ANTE
Vetro ad infilare

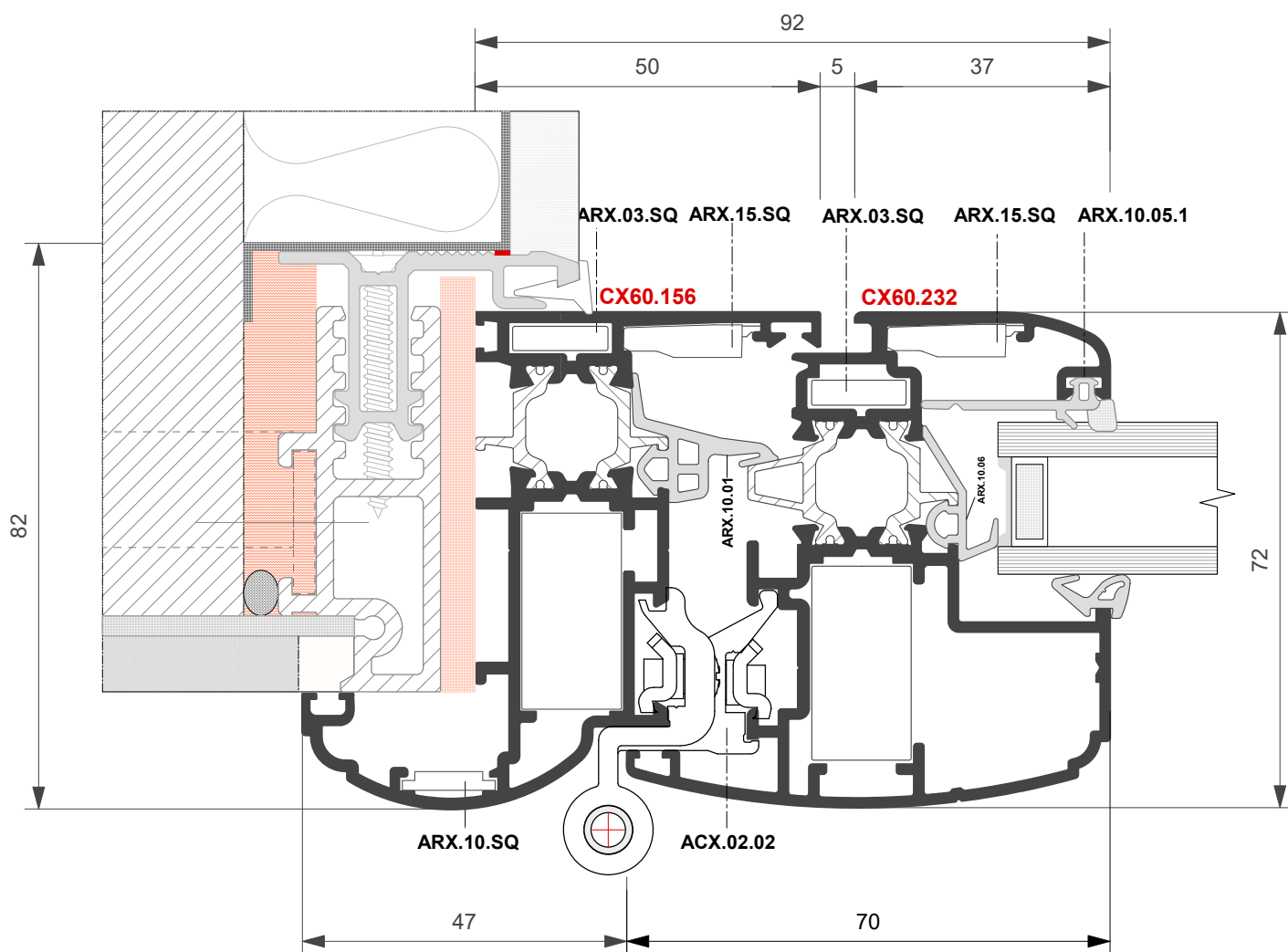
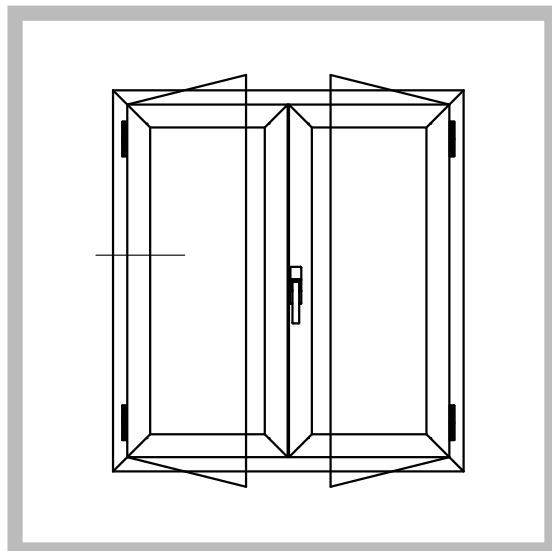



FINESTRA A DUE ANTE
Vetro ad infilare

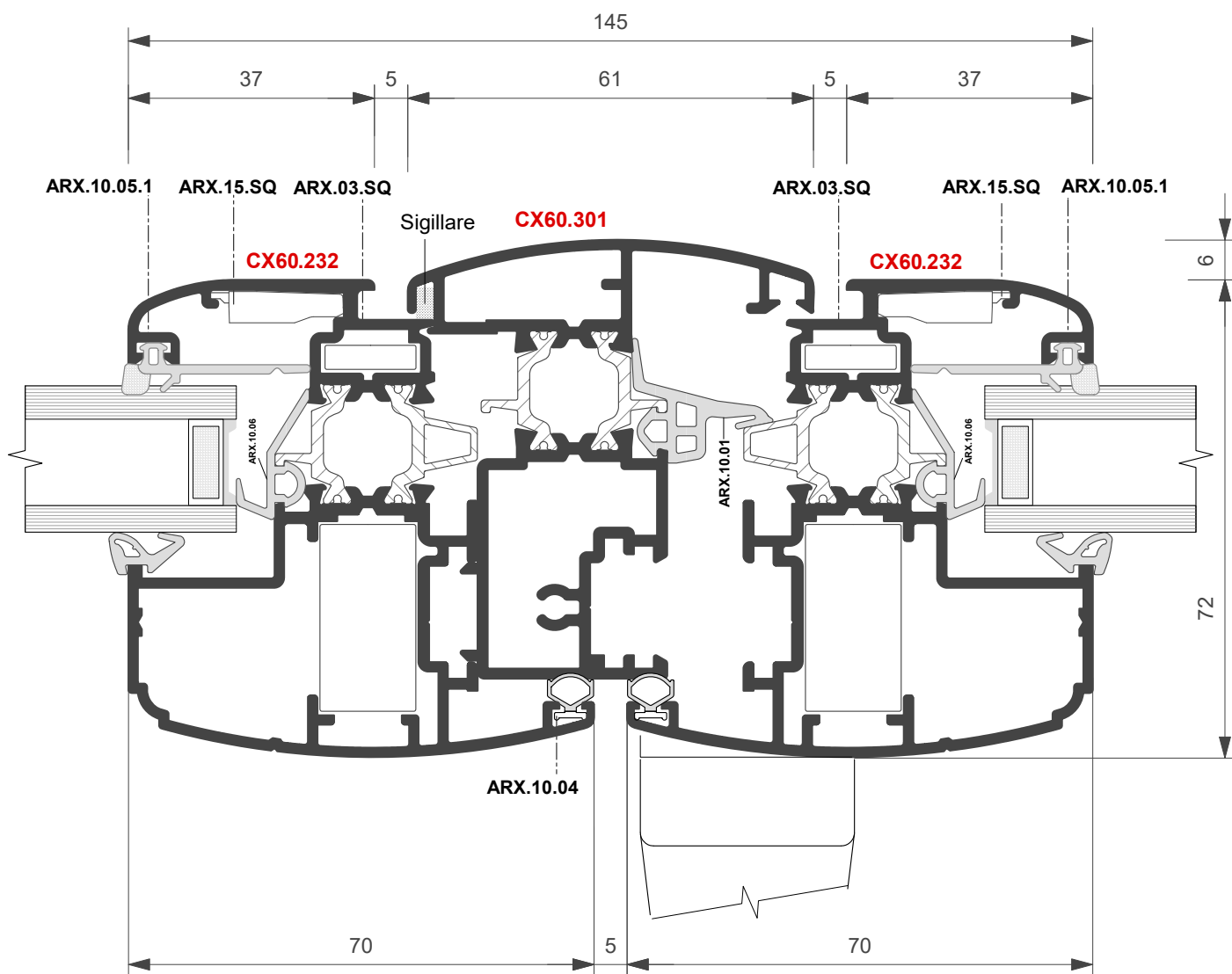
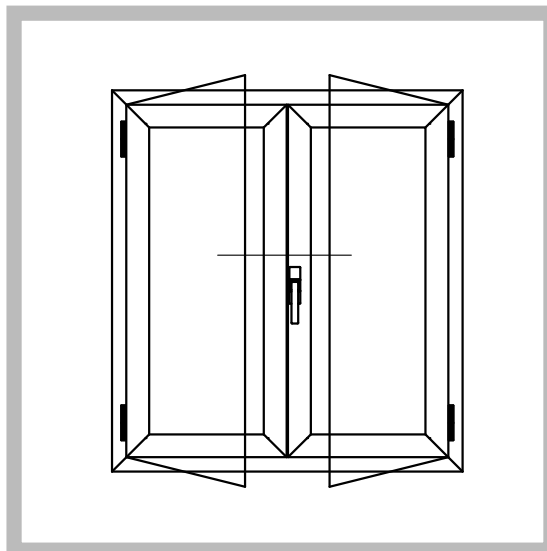



PORTA BALCONE A DUE ANTE
Vetro ad infilare

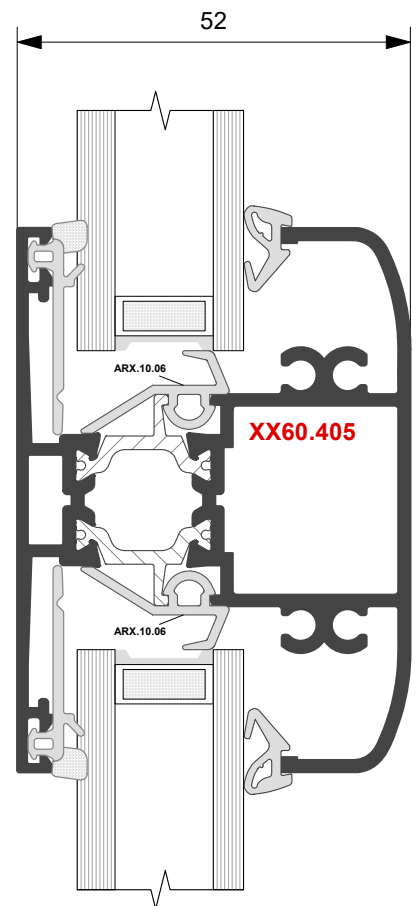
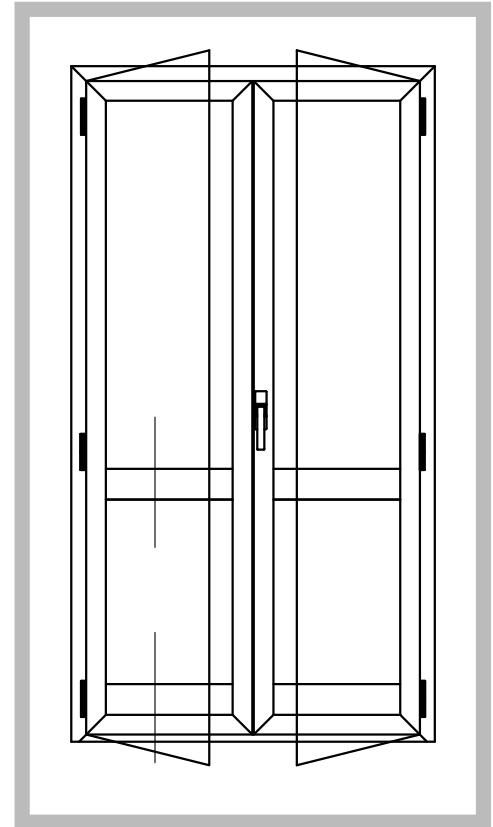
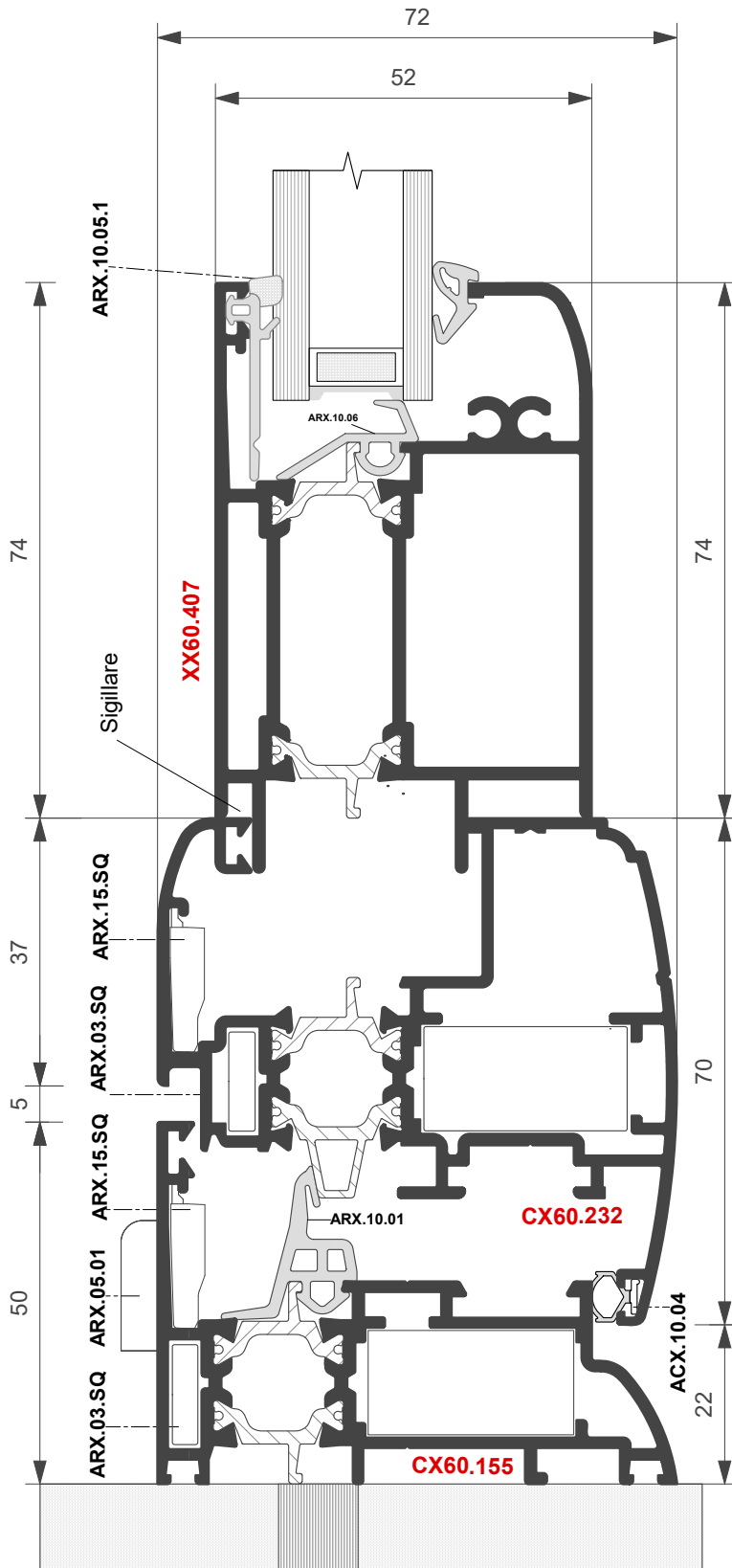

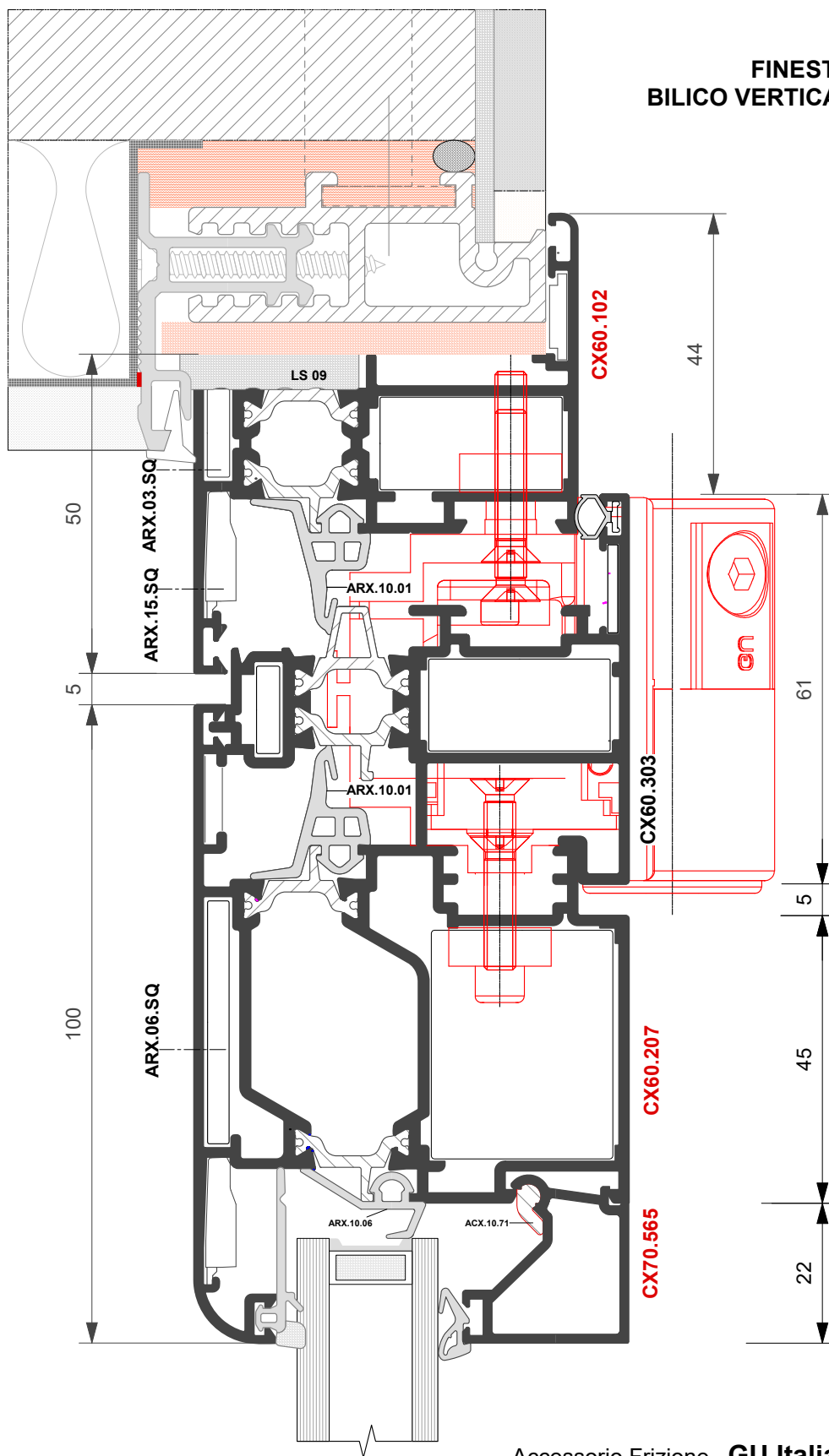

**FINESTRA
BILICO VERTICALE**

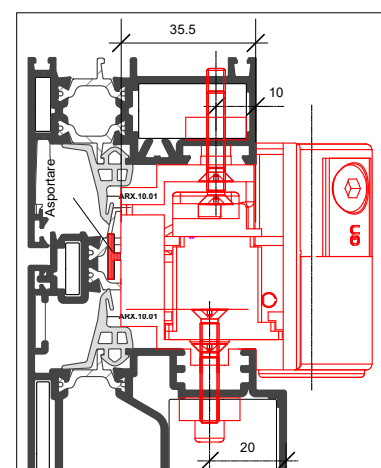
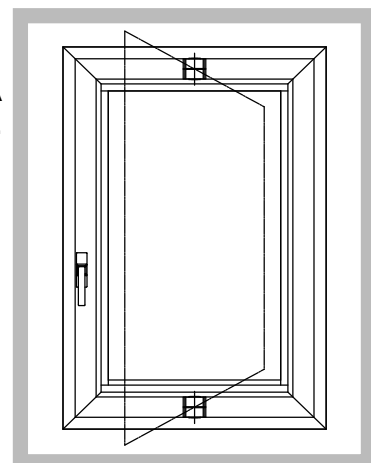

Accessorio Frizione **GU Italia U - 88**
Articolo 6 - 27337-08 - P
 per accessori di movimentazione riferirsi
 alla tavola di assieme



ELEMENTO FISSO

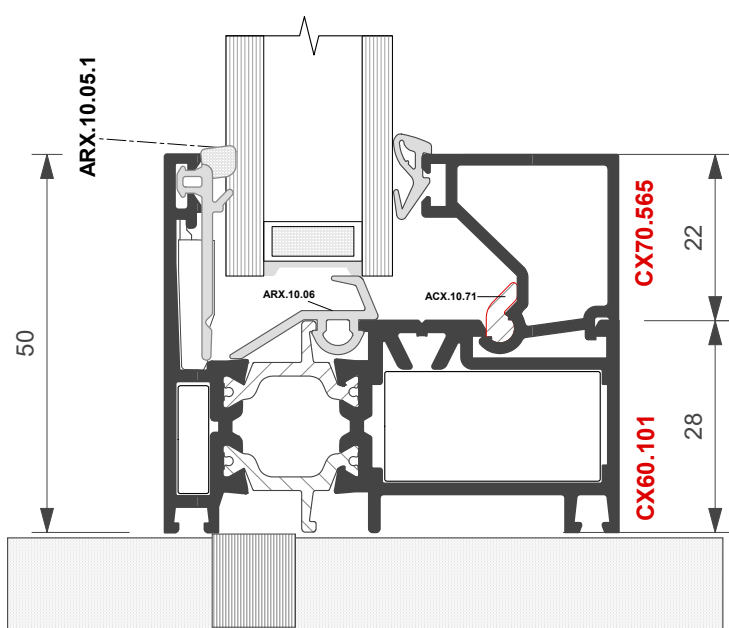
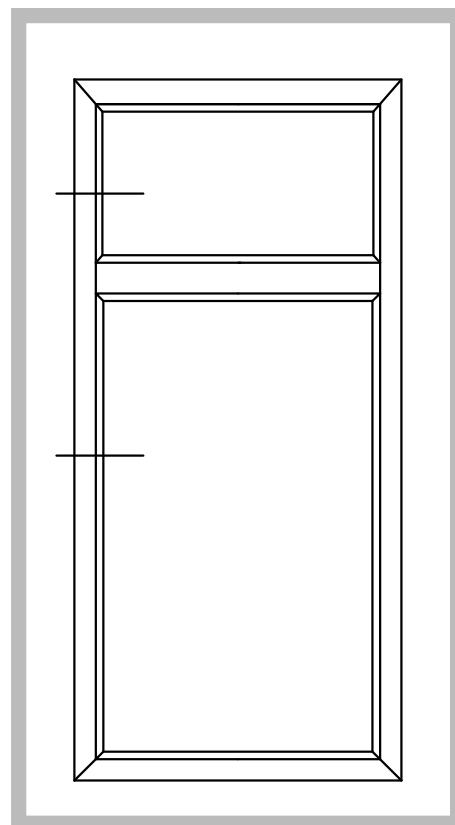
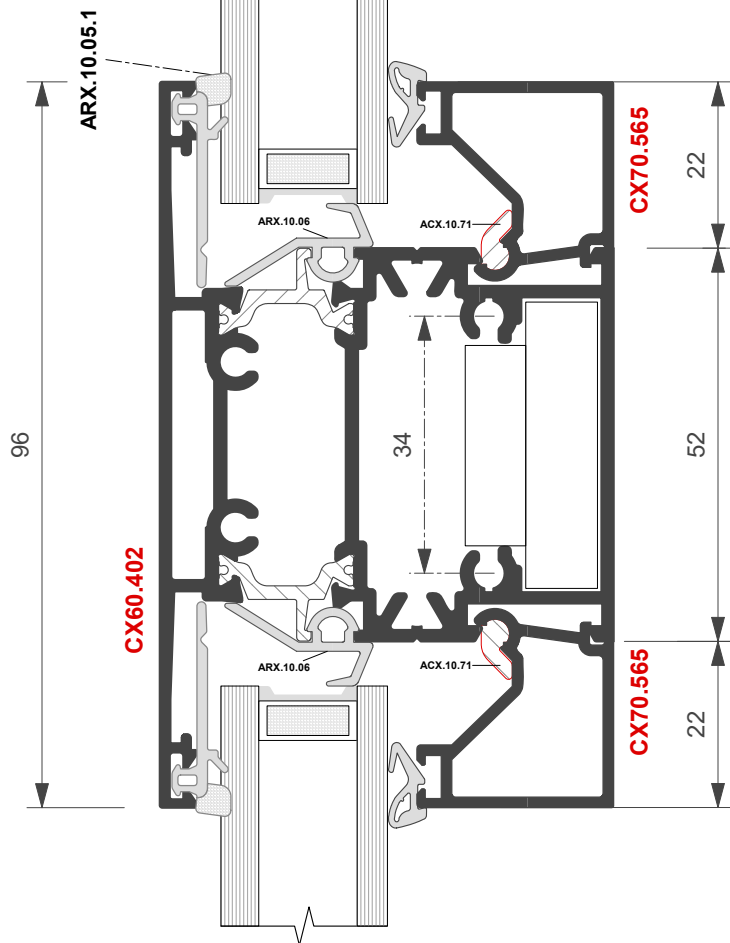



Ferramenta a nastro

FINESTRA A DUE ANTE

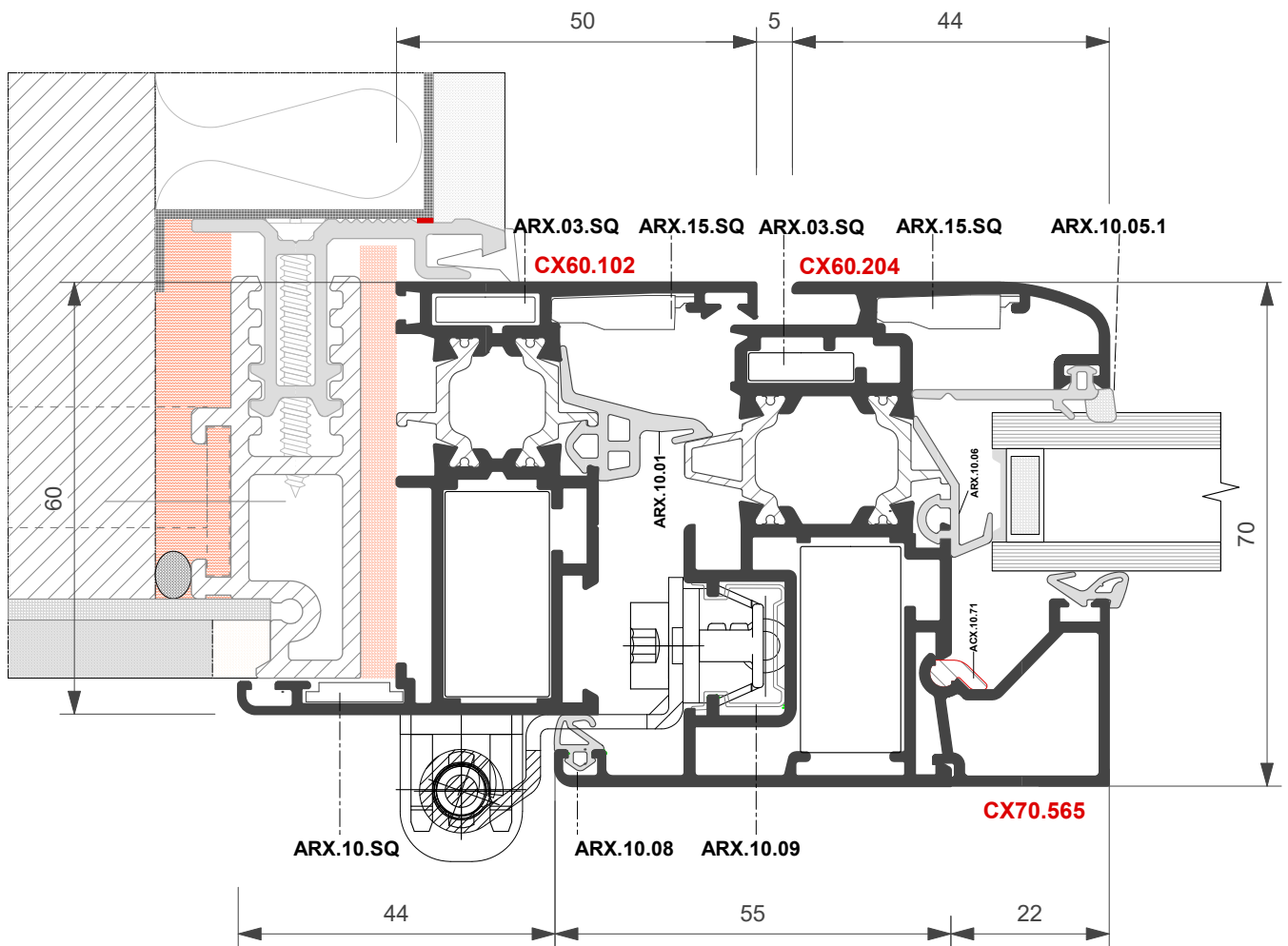
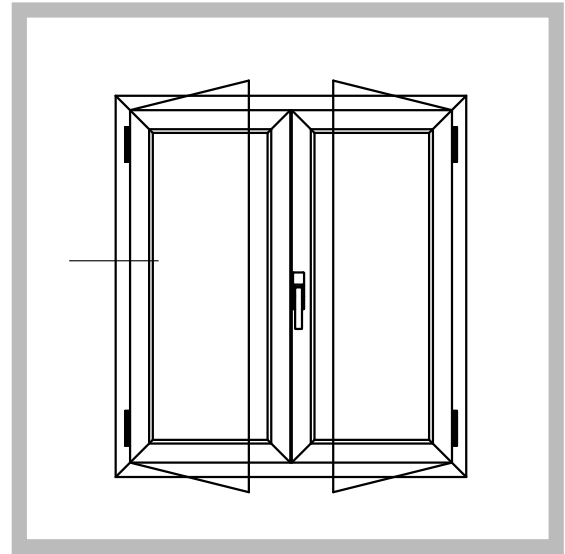



Ferramenta a nastro

FINESTRA A DUE ANTE

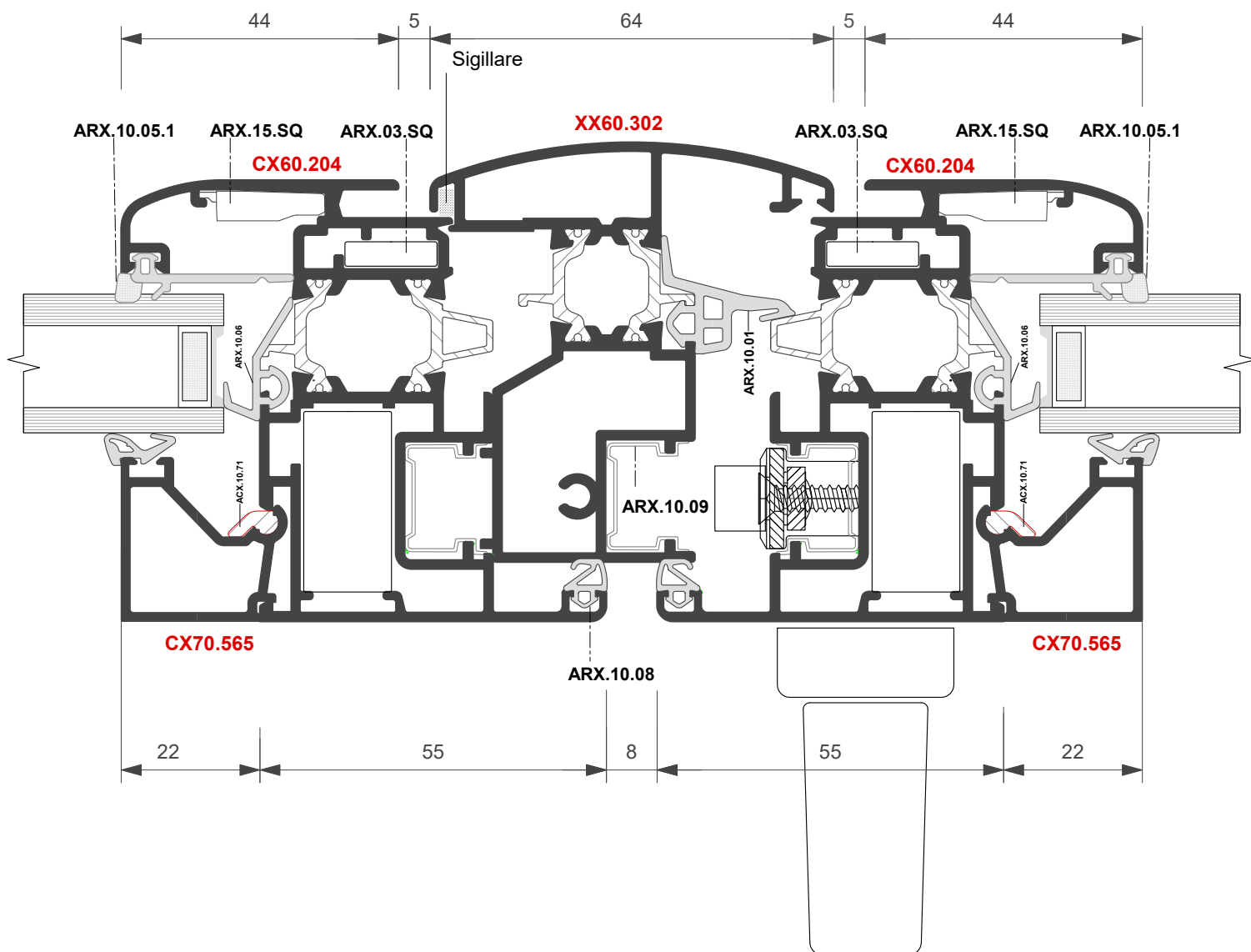
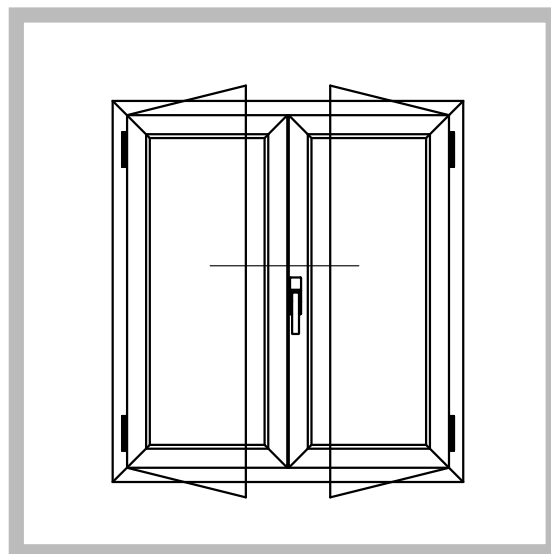



FINESTRA A DUE ANTE
Scorrevole in parallelo

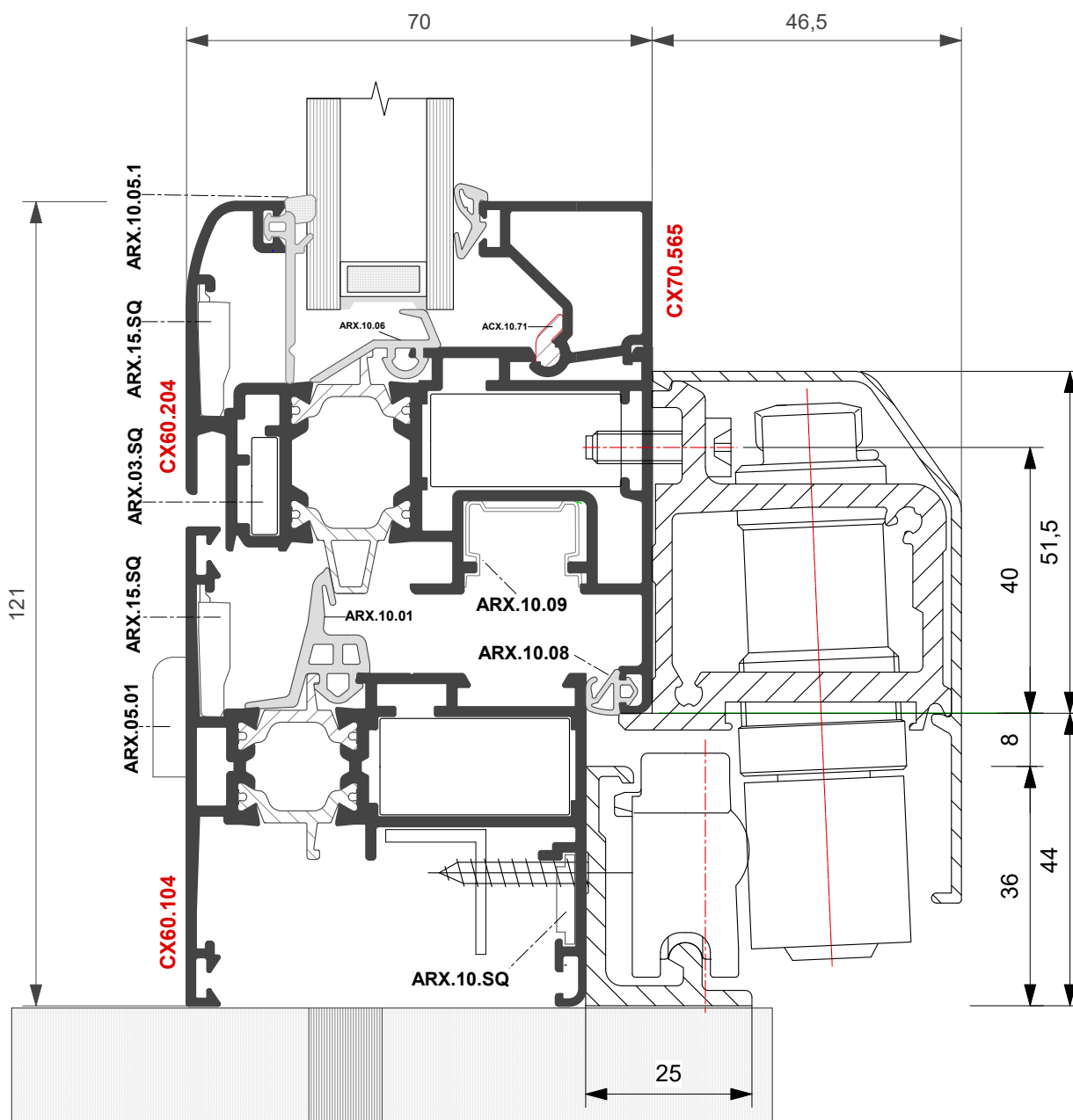
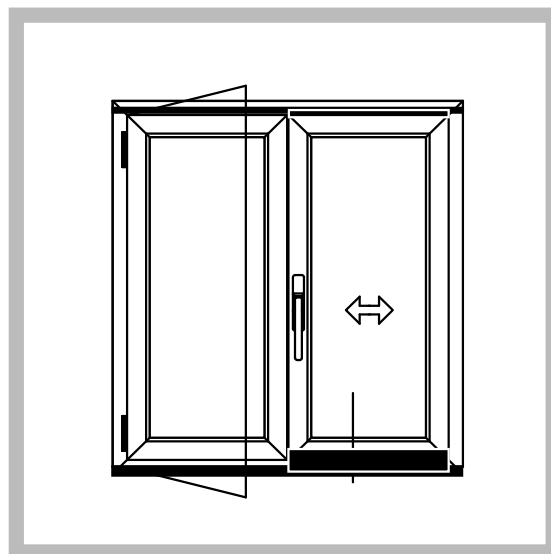



Ferramenta a nastro

FINESTRA A DUE ANTE
Scorrevole in parallelo

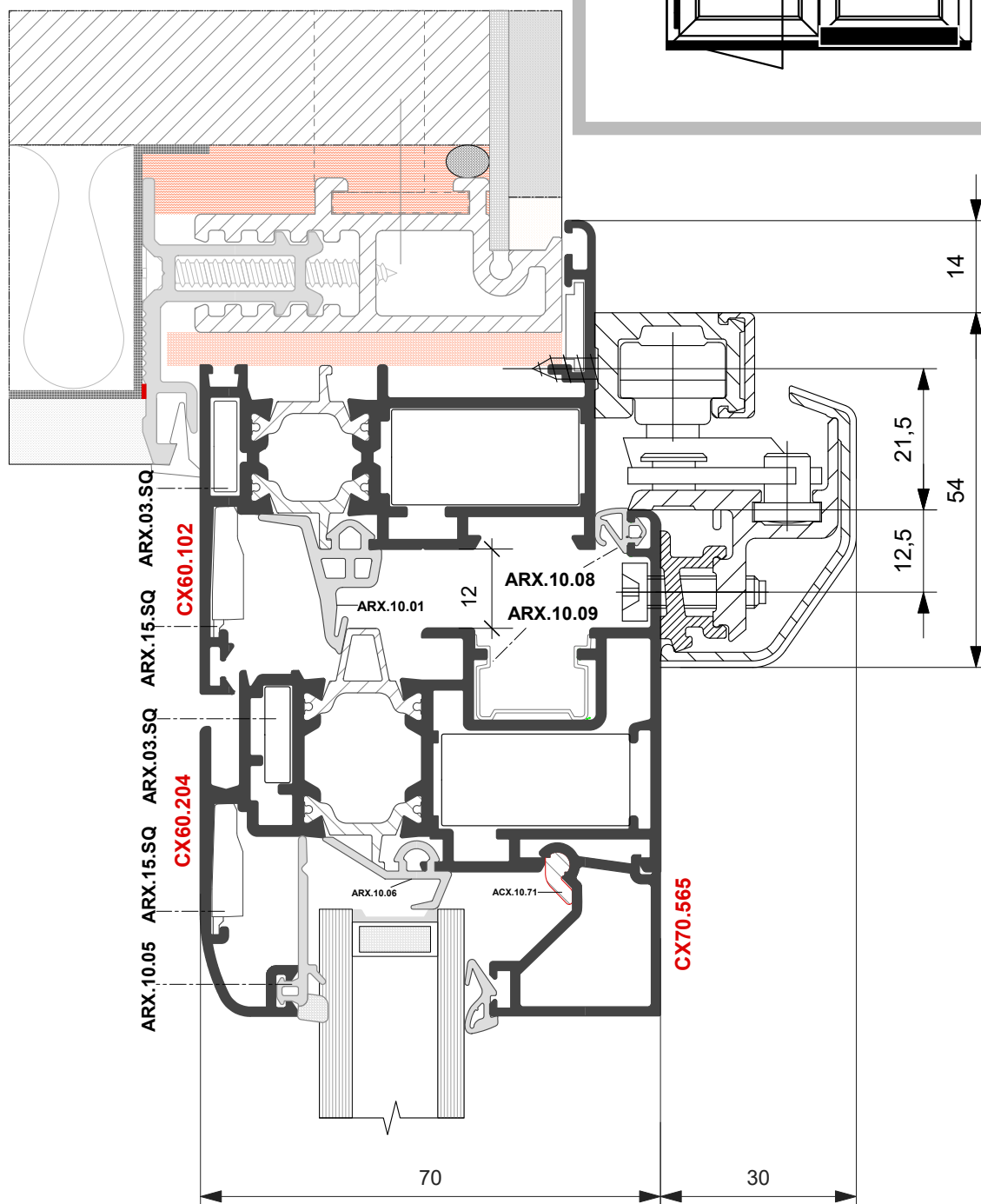
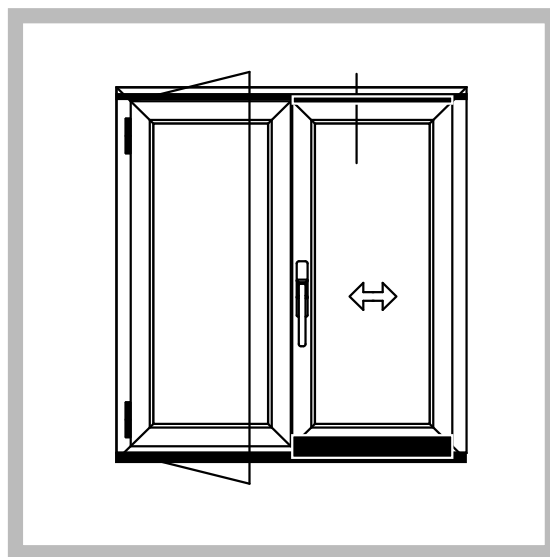



Ferramenta a nastro

PORTA BALCONE A DUE ANTE

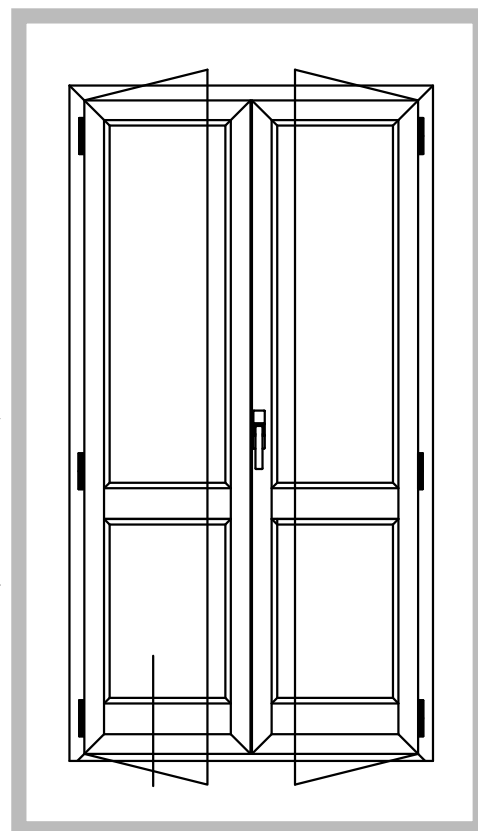
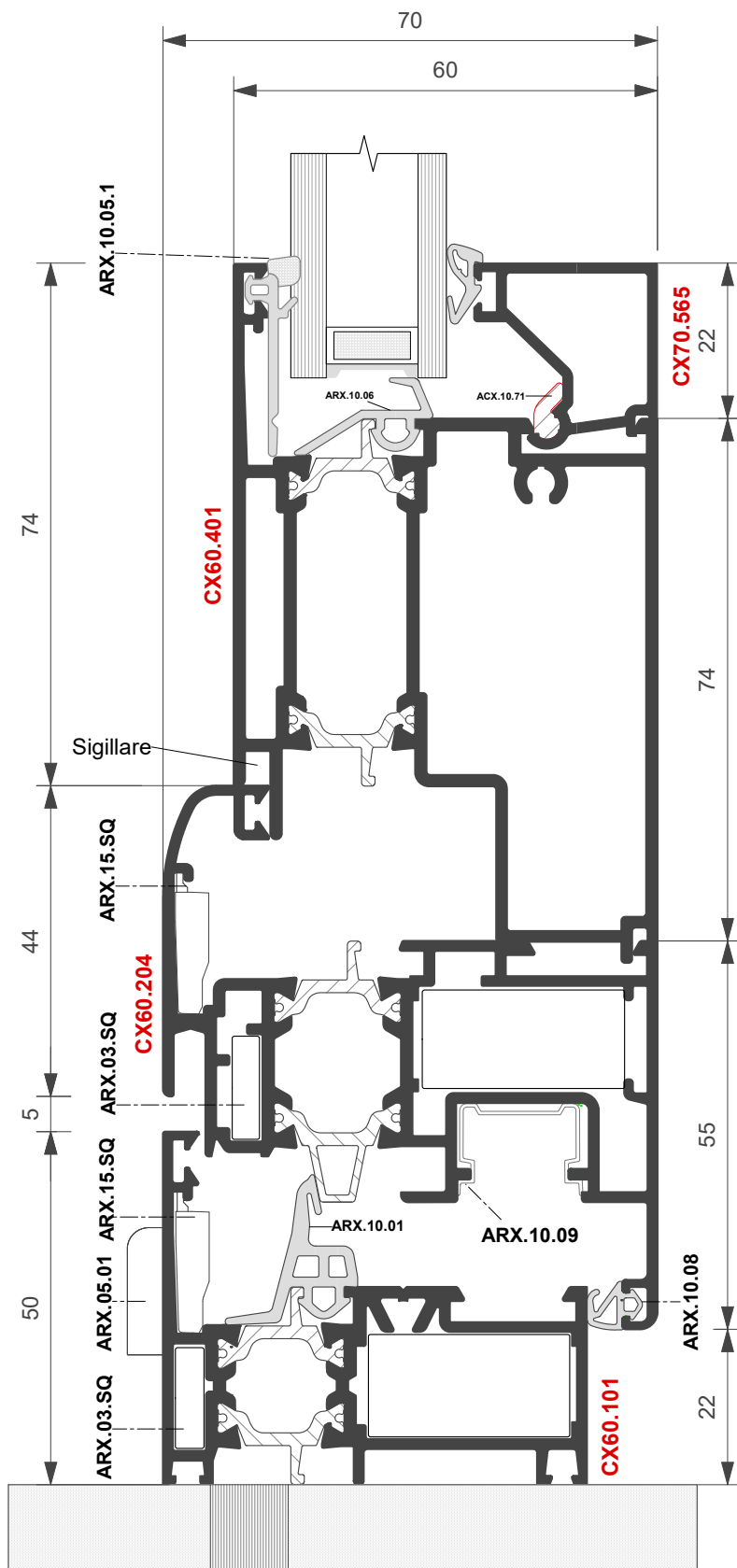



Ferramenta a nastro

PORTA BALCONE A DUE ANTE

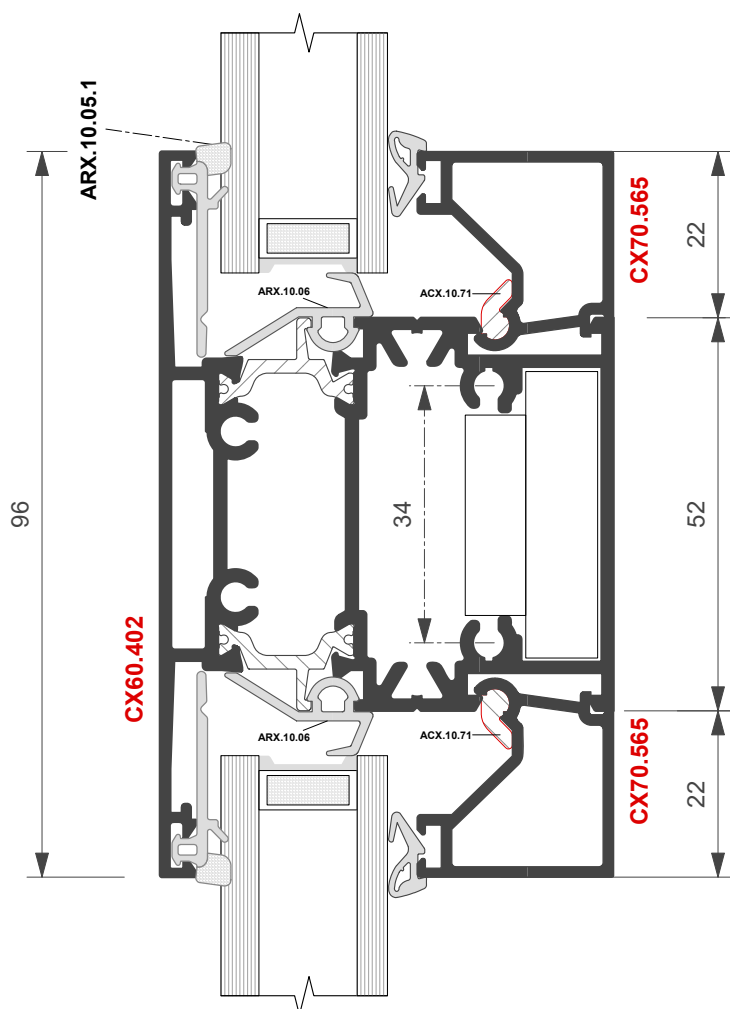
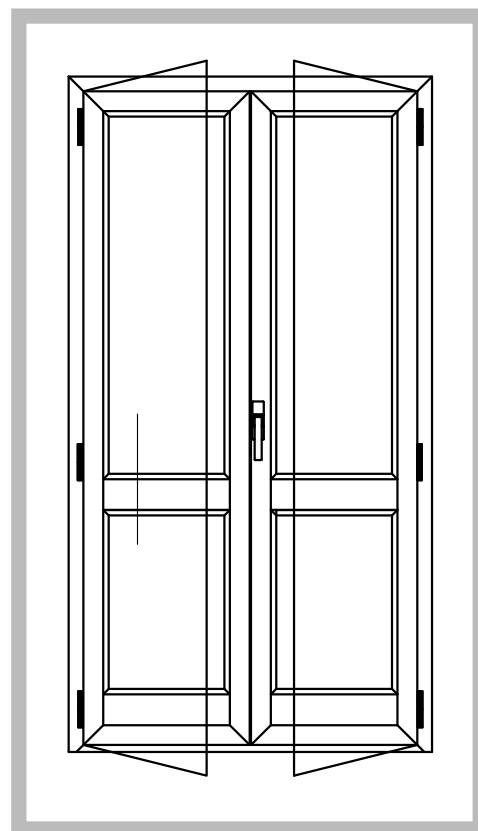



**FINESTRA
BILICO ORIZZONTALE**

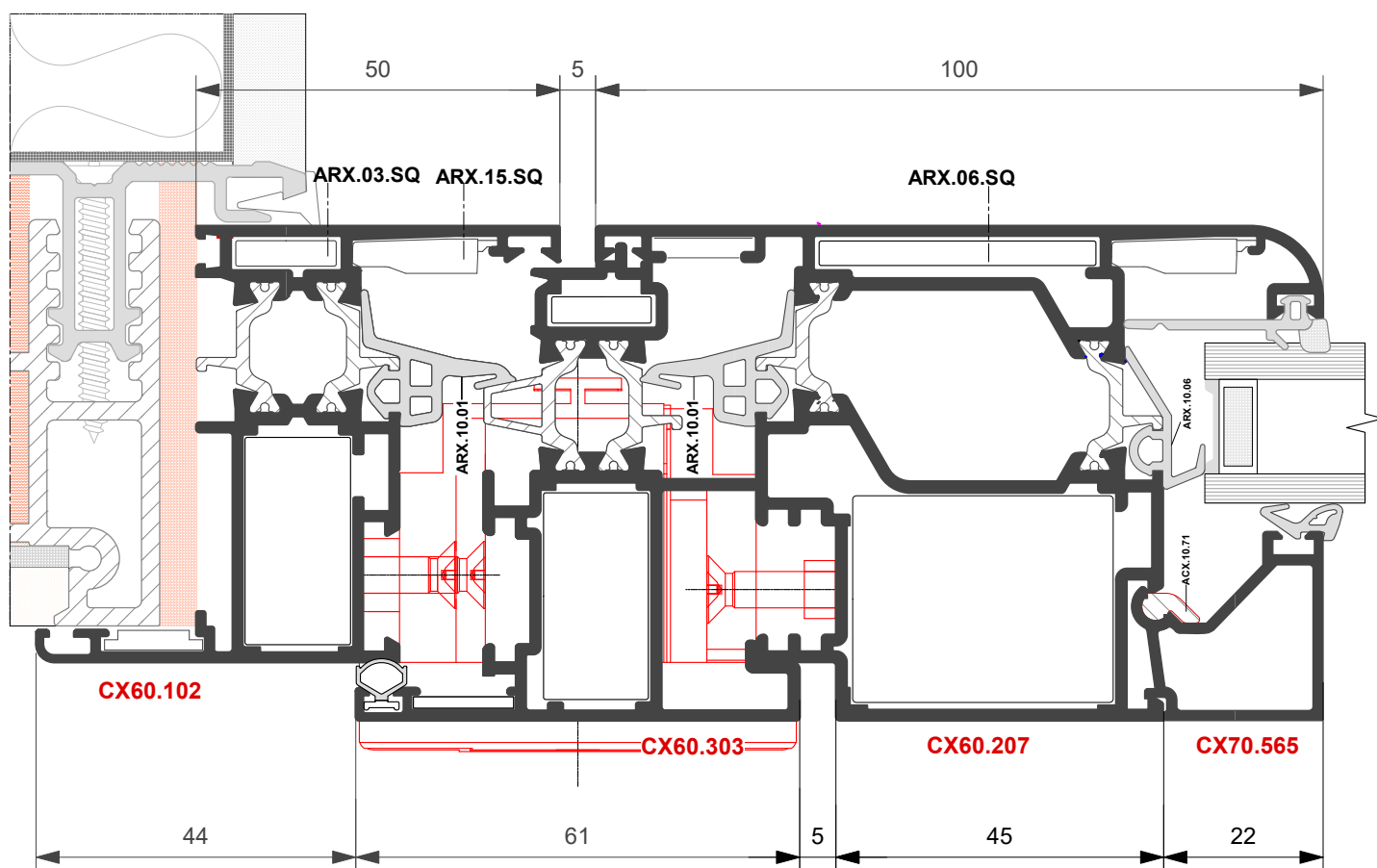
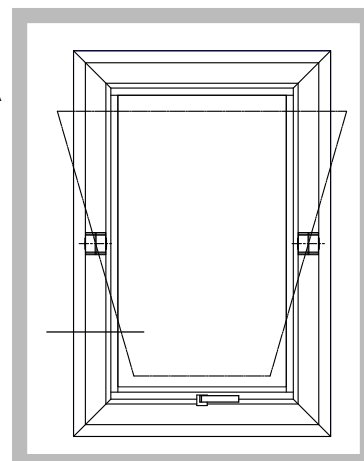
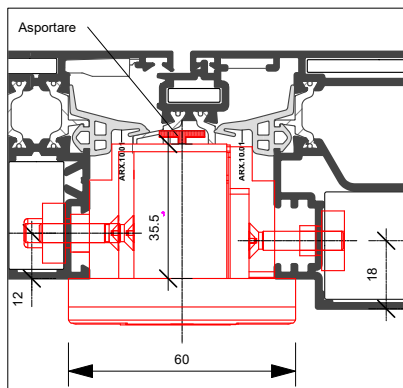

Accessorio Frizione **GU Italia U - 18/3**

Articolo 6 - 27212 - 07 - P

per accessori di movimentazione riferirsi
alla tavola di assieme



ABBINAMENTO CON SCORREVOLE SX 700

Telaio in appoggio

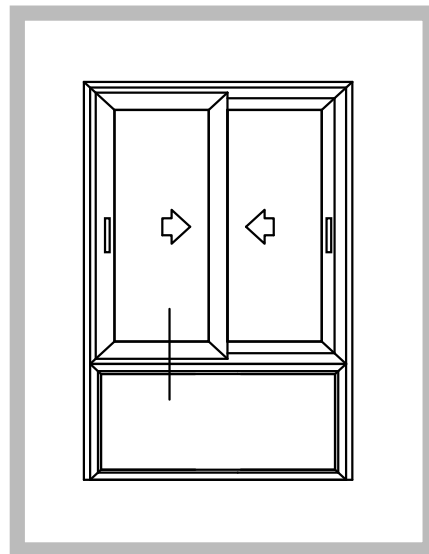
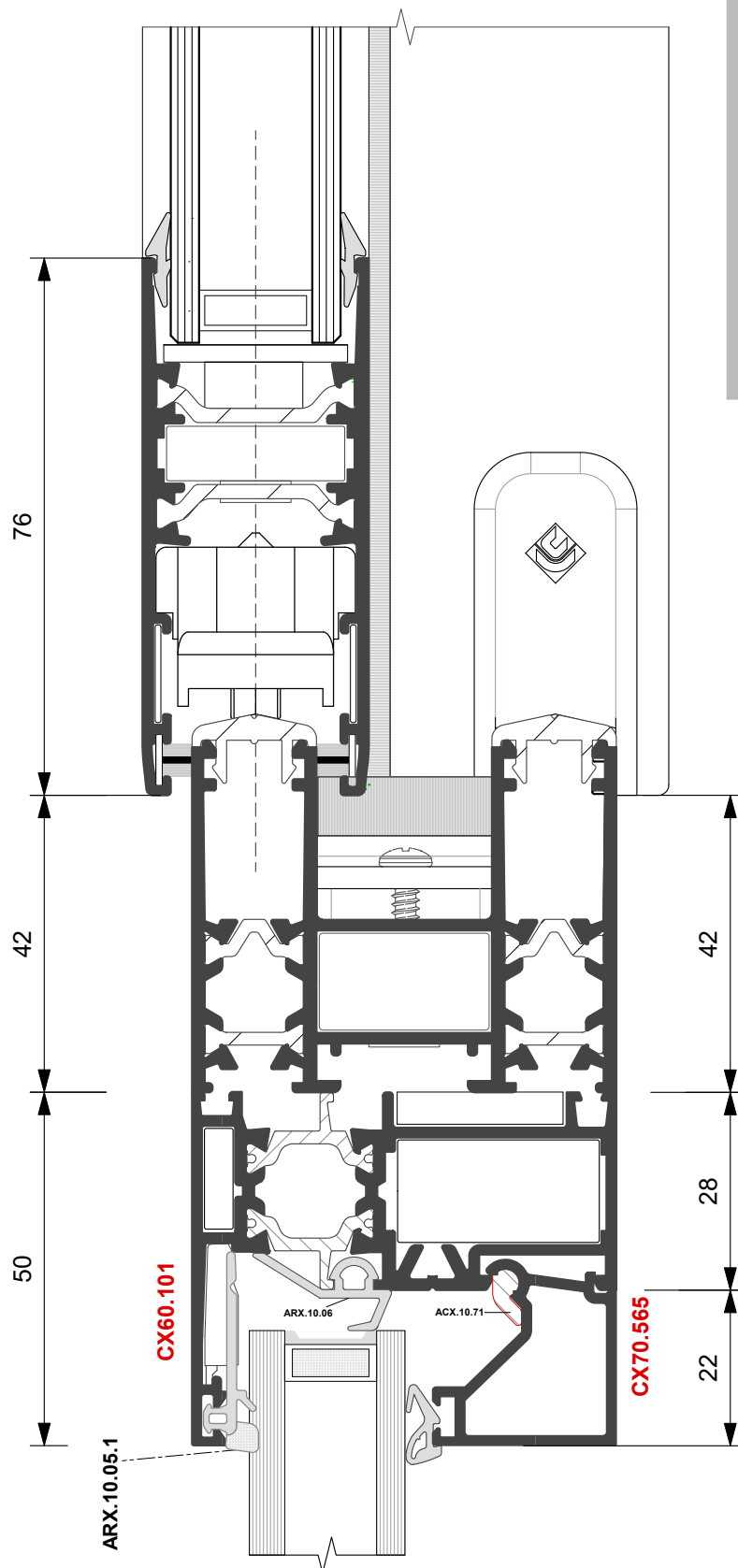

Per i riferimenti della serie SX 700 consultare il relativo catalogo.



TELAIO CAPANNONI

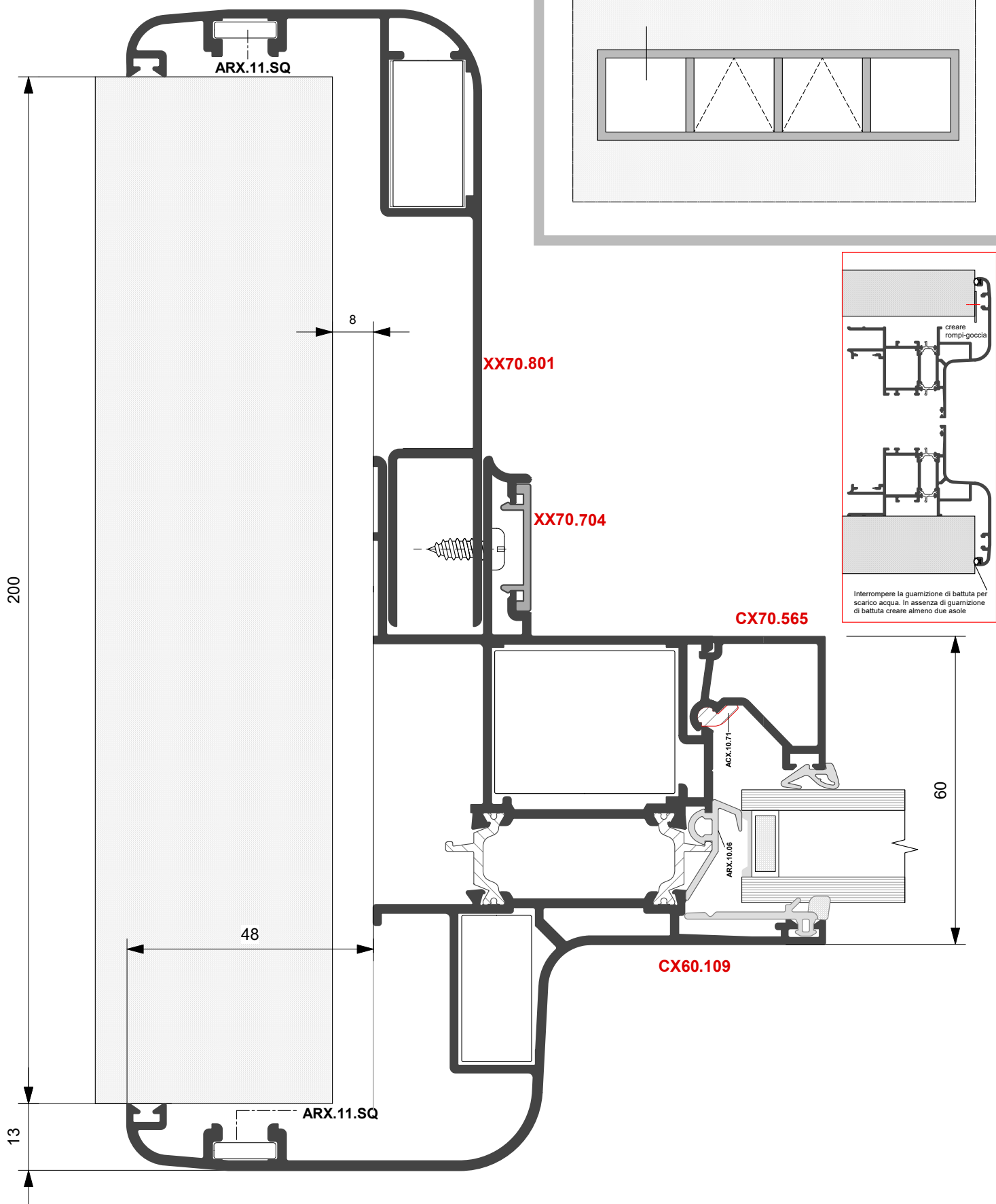



TELAIO CAPANNONI

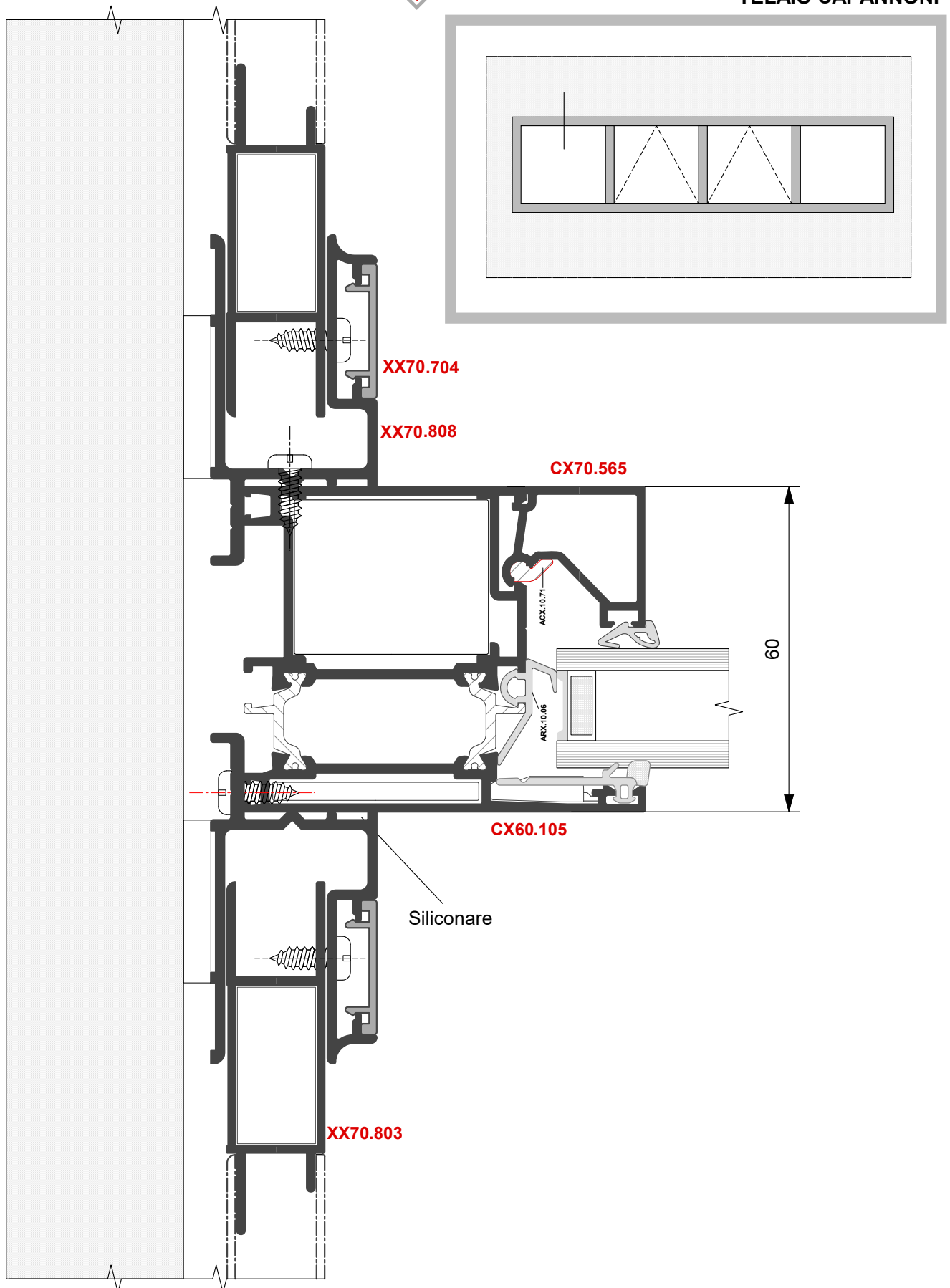



TELAI COMPENSAZIONE

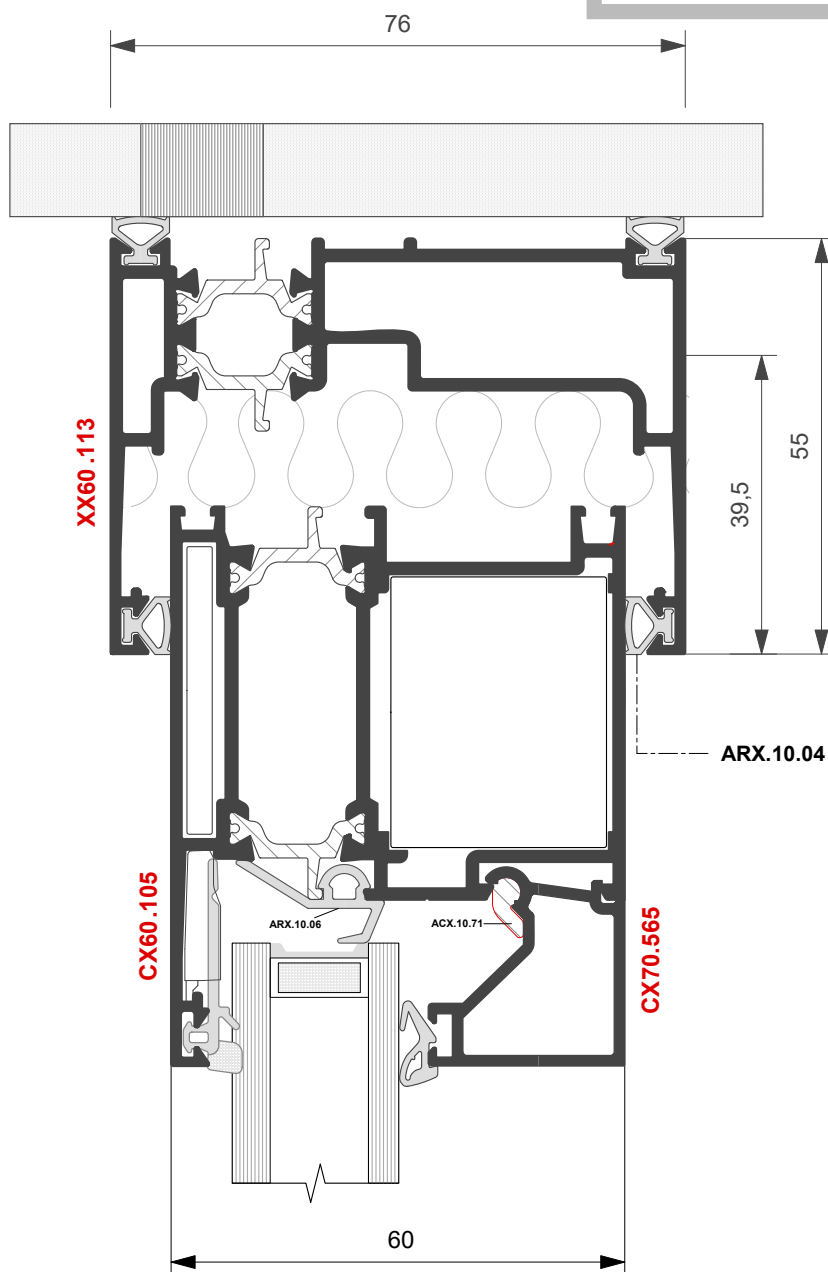
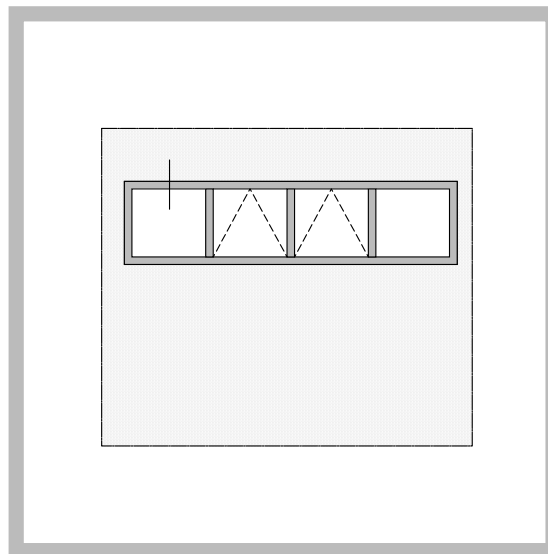



PROFILO UNIVERSALE PER ANGOLO A 90°

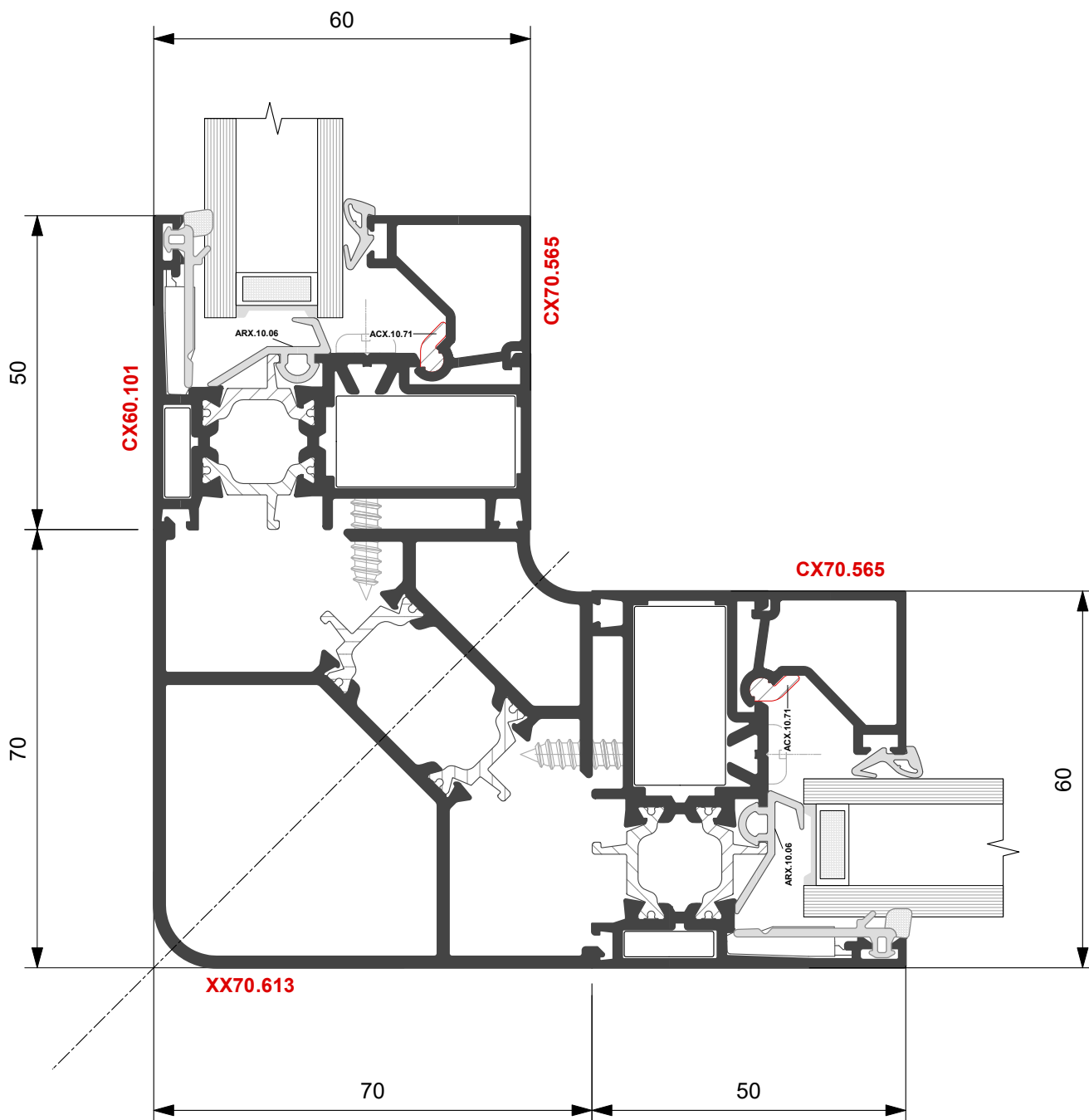



PORTA DI INGRESSO A 2 ANTE

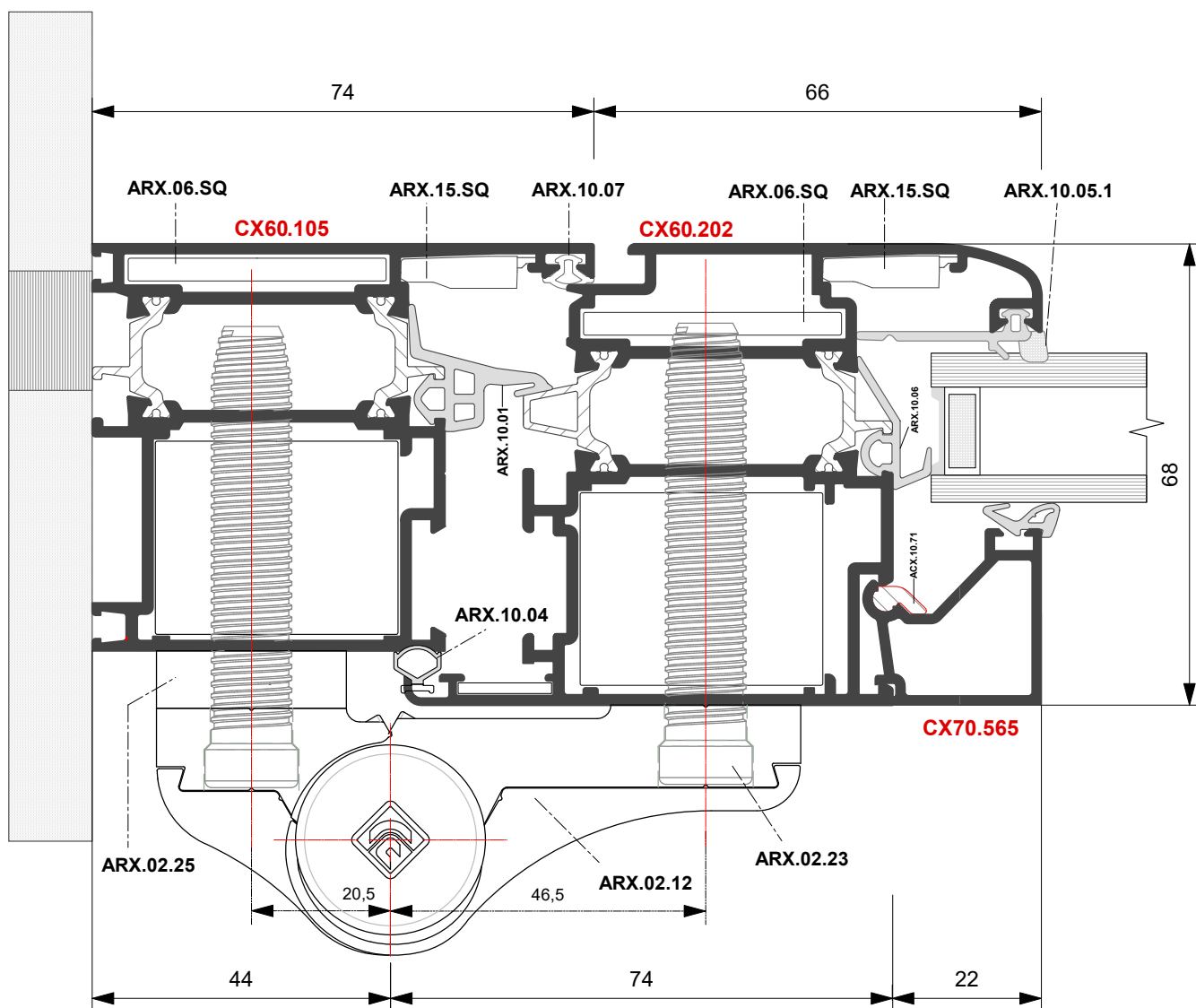
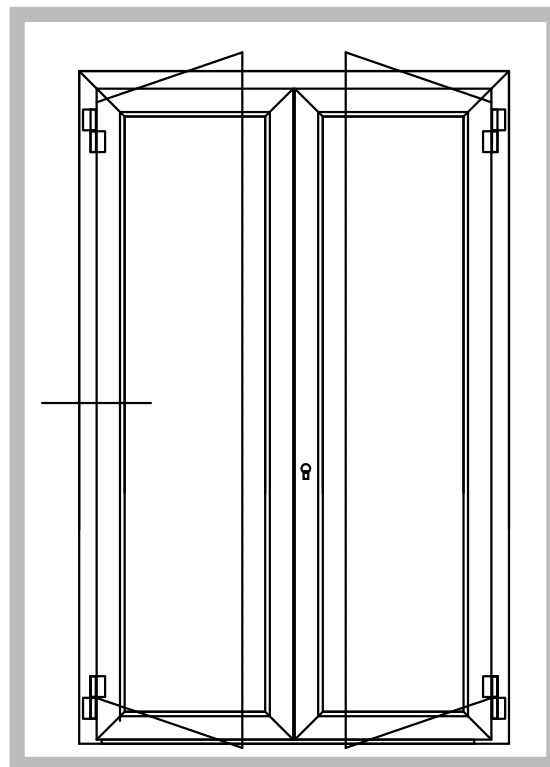



PORTA DI INGRESSO A 2 ANTE

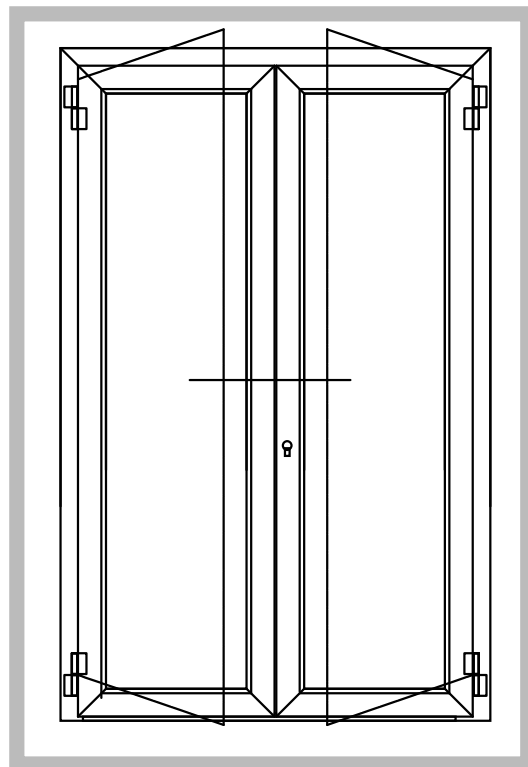
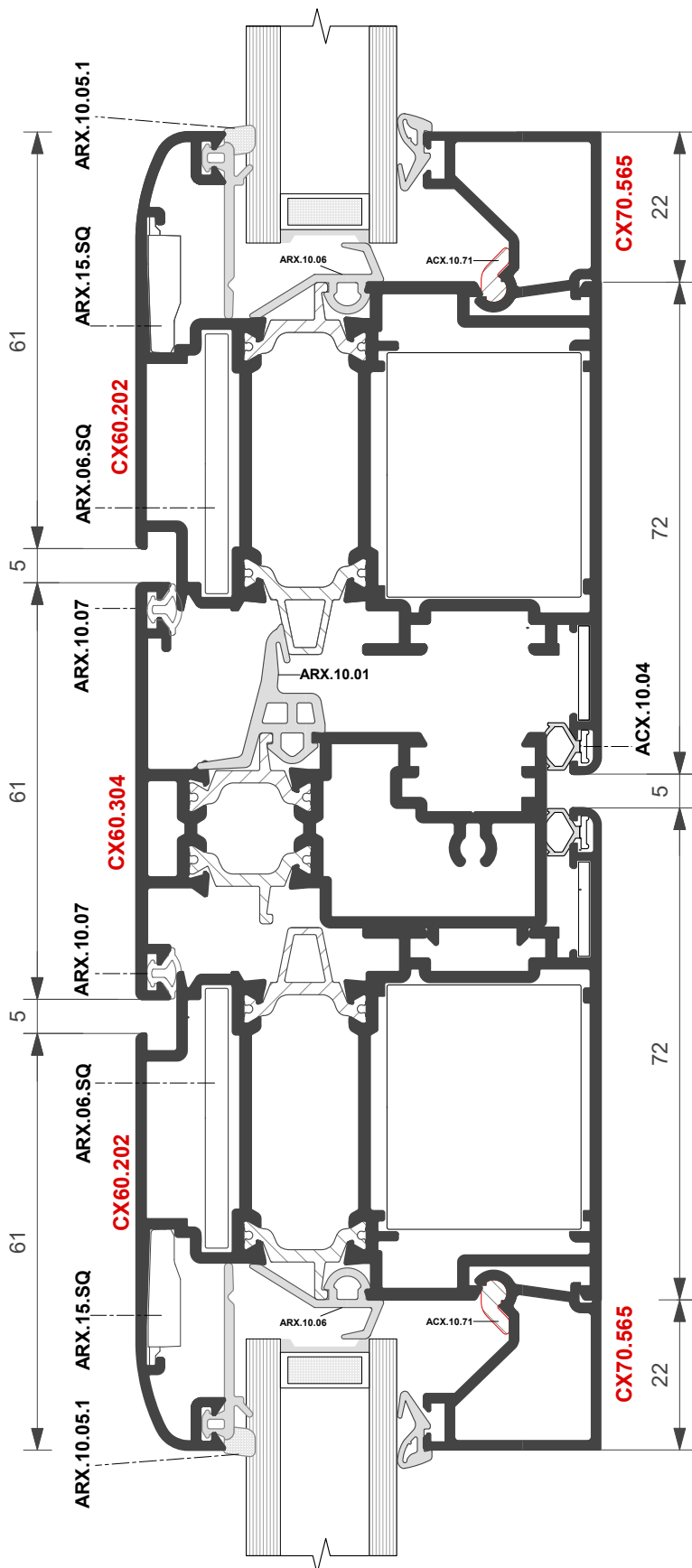



PORTA INGRESSO AD UNA ANTA

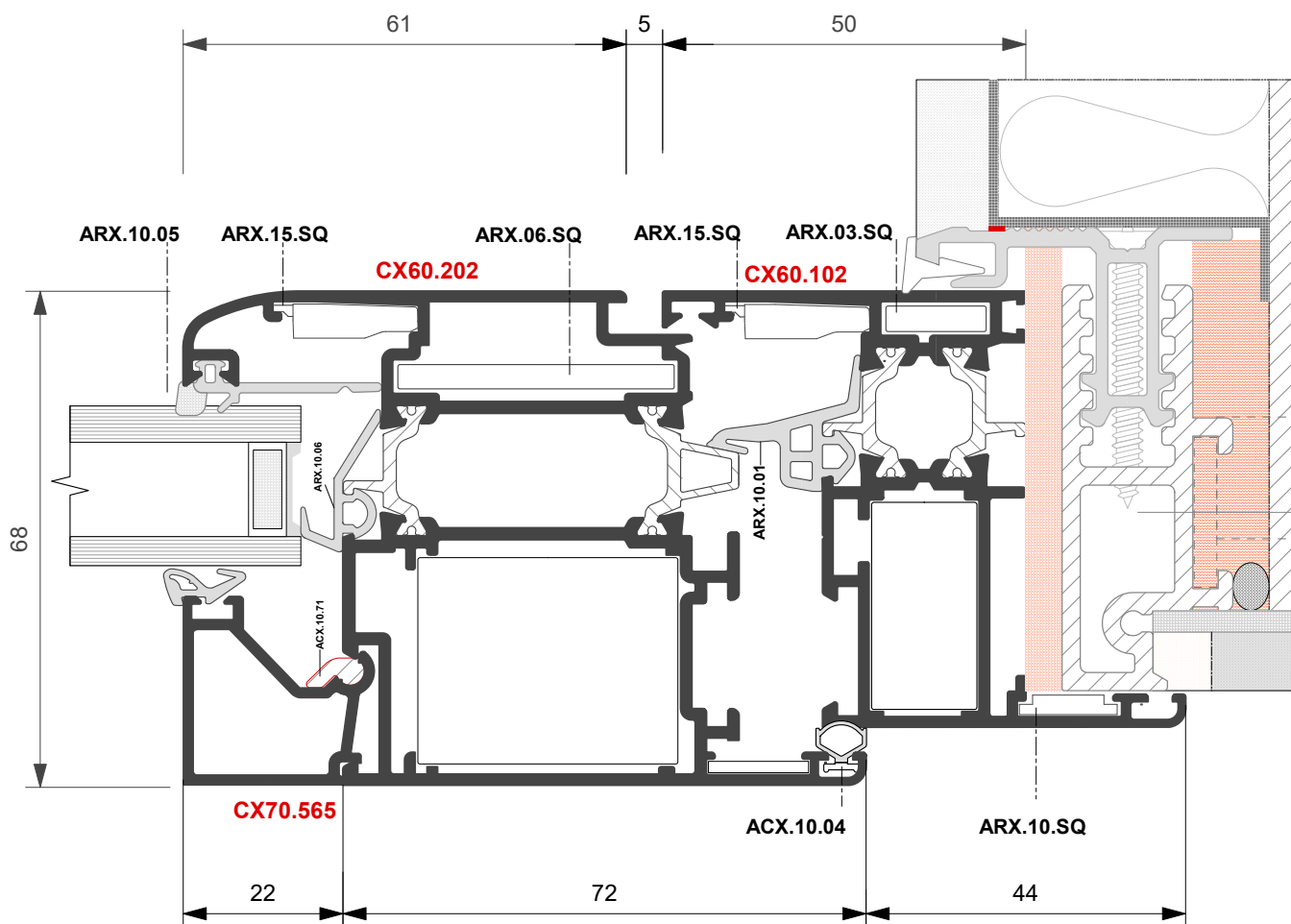
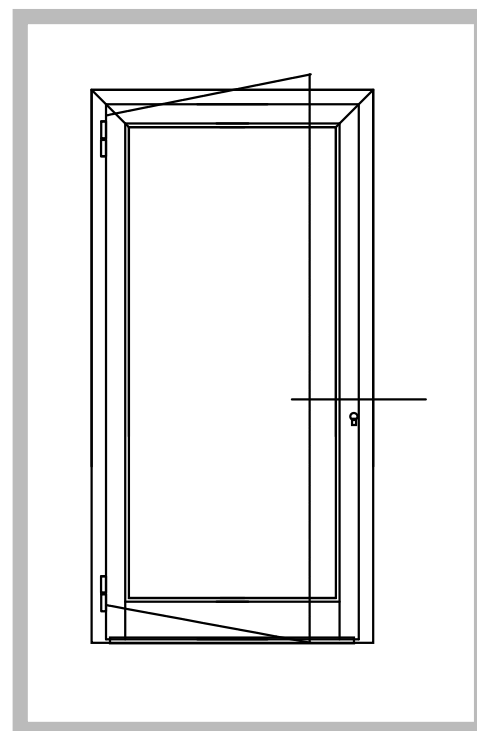



PORTA DI INGRESSO A 2 ANTE

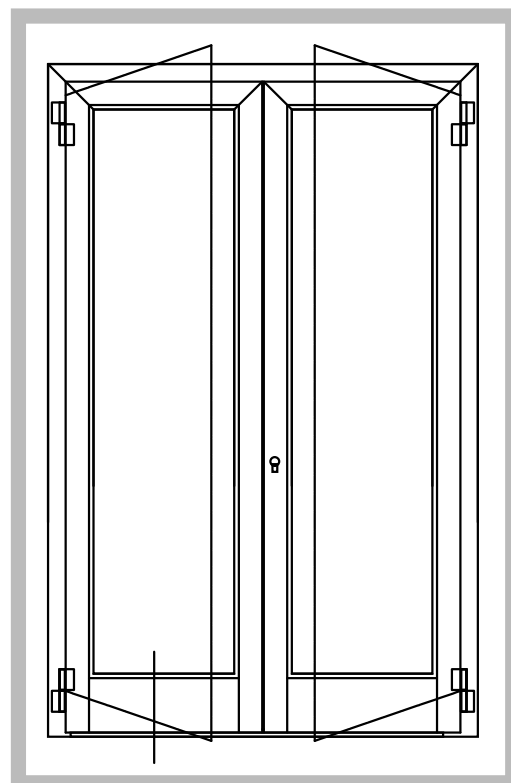
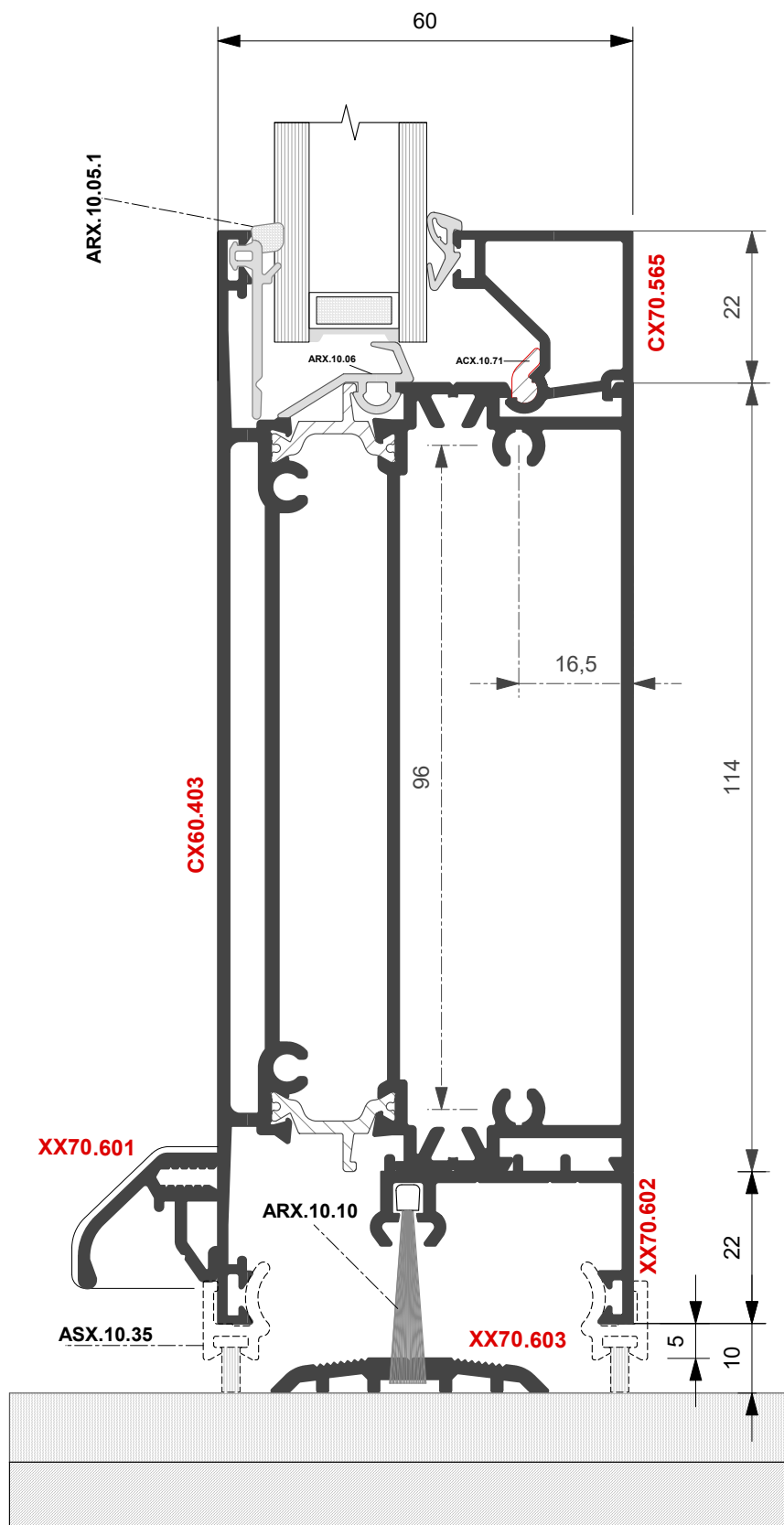



PORTA DI INGRESSO A 2 ANTE

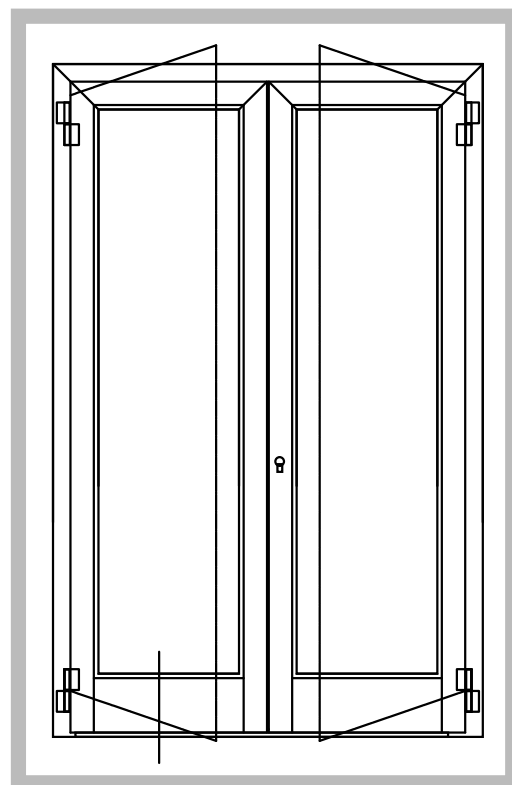
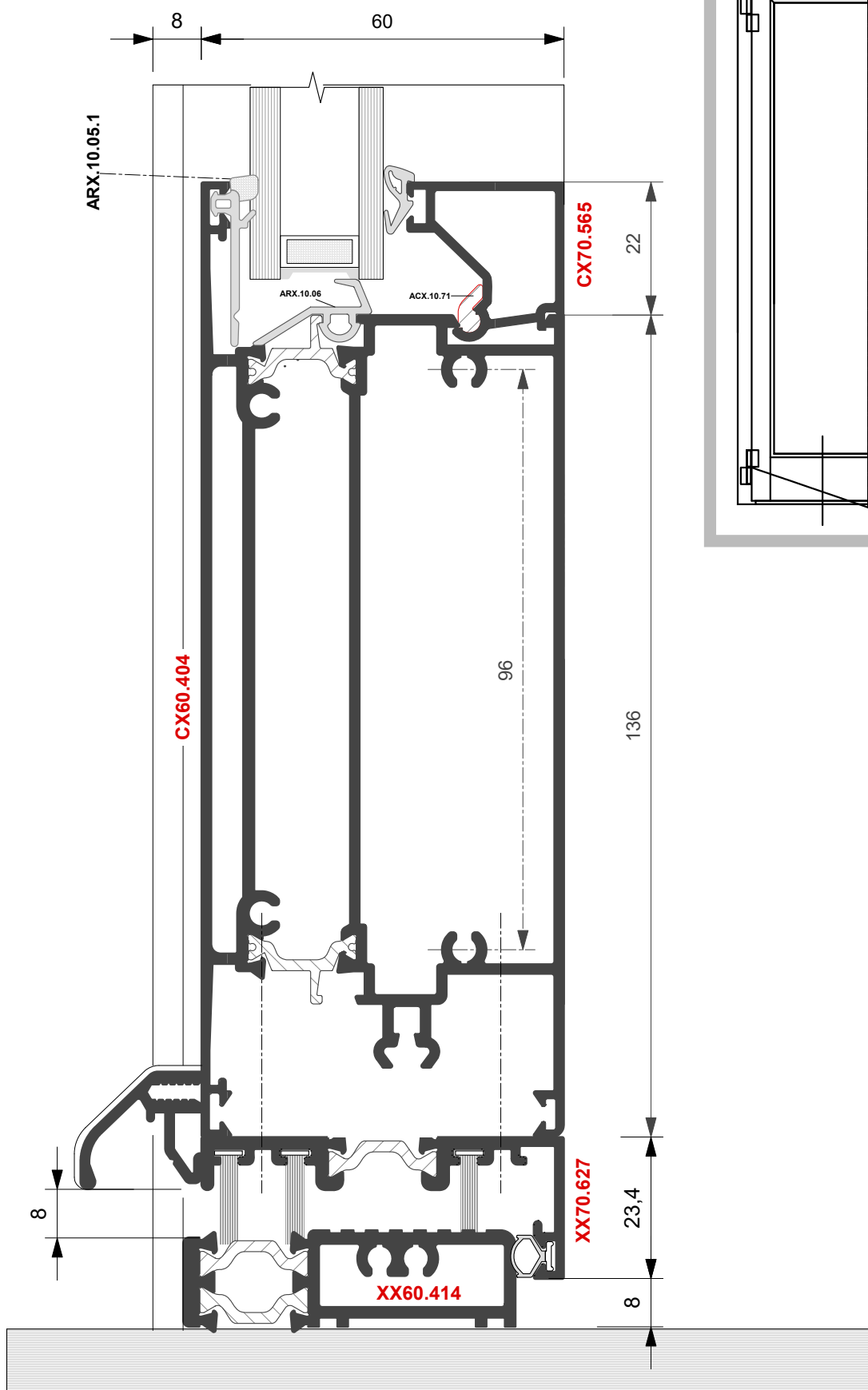

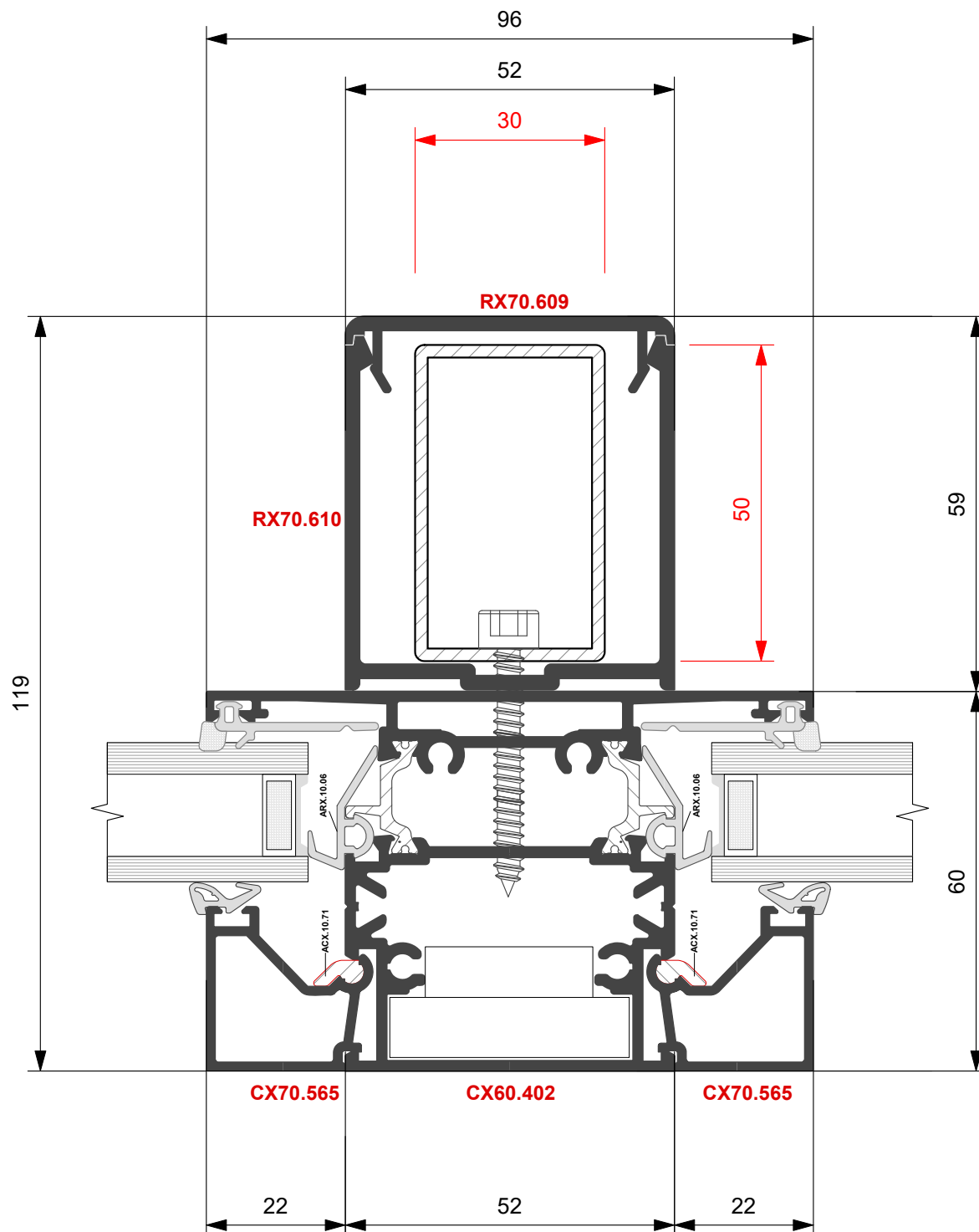

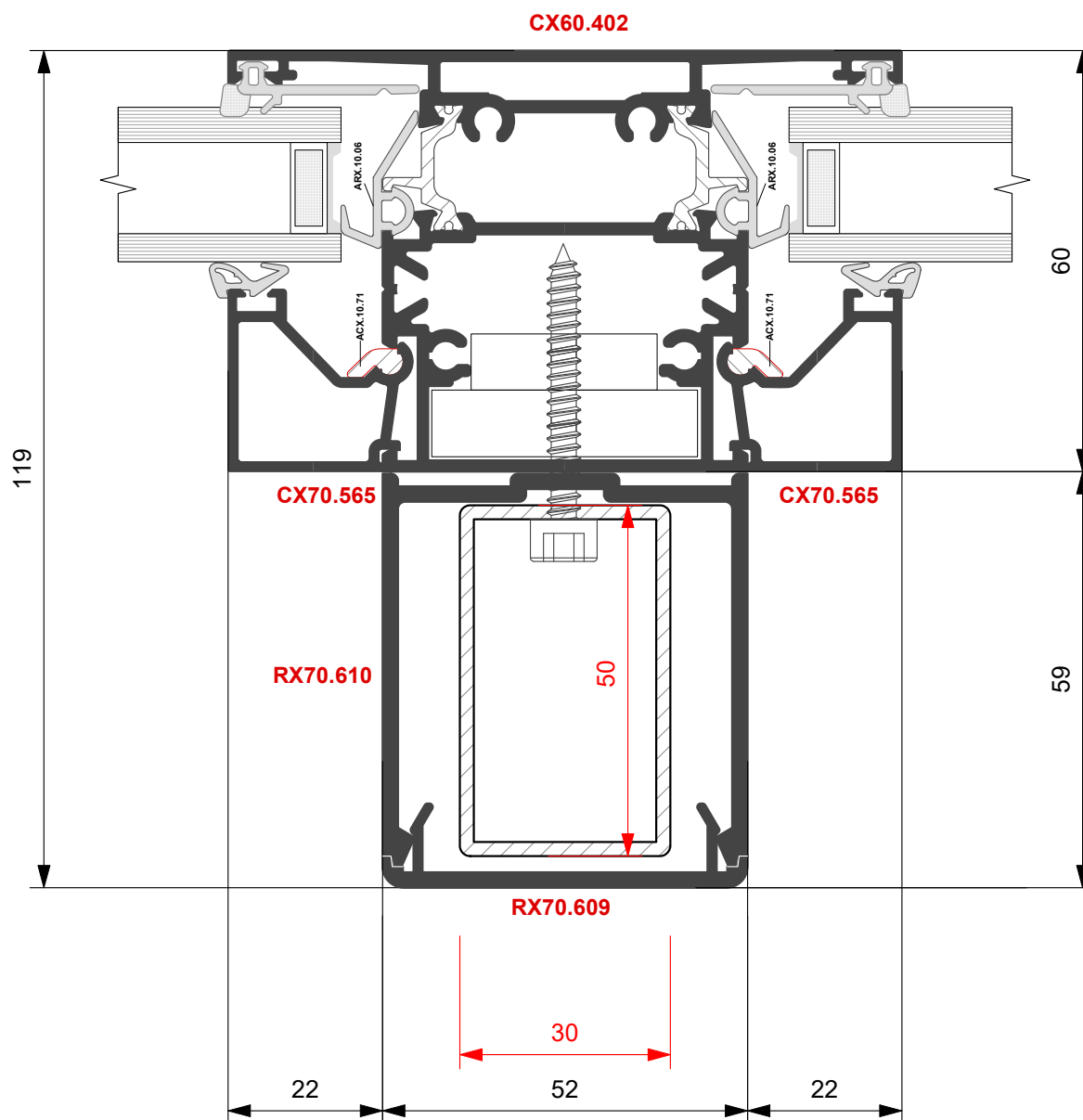

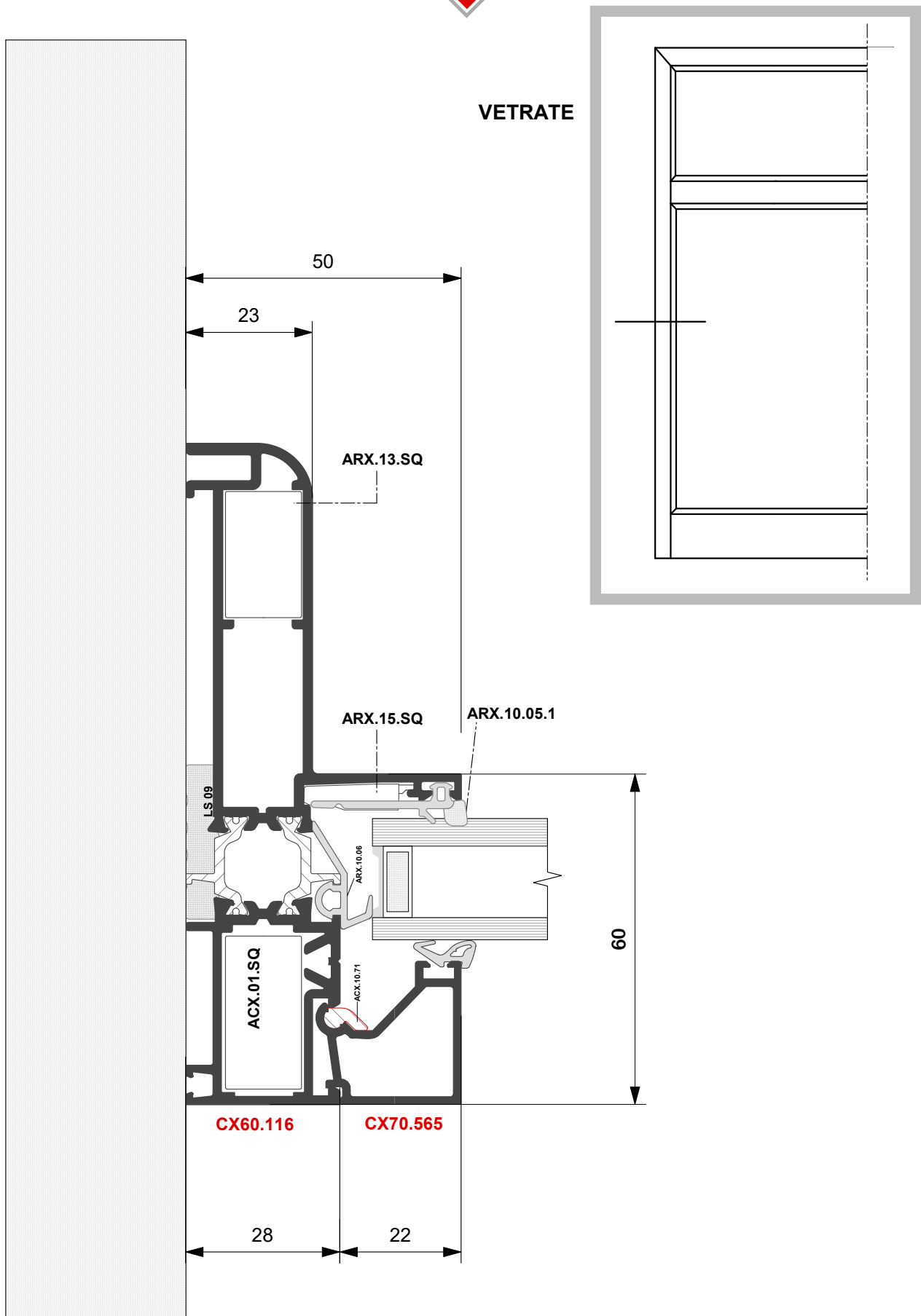



VETRATE

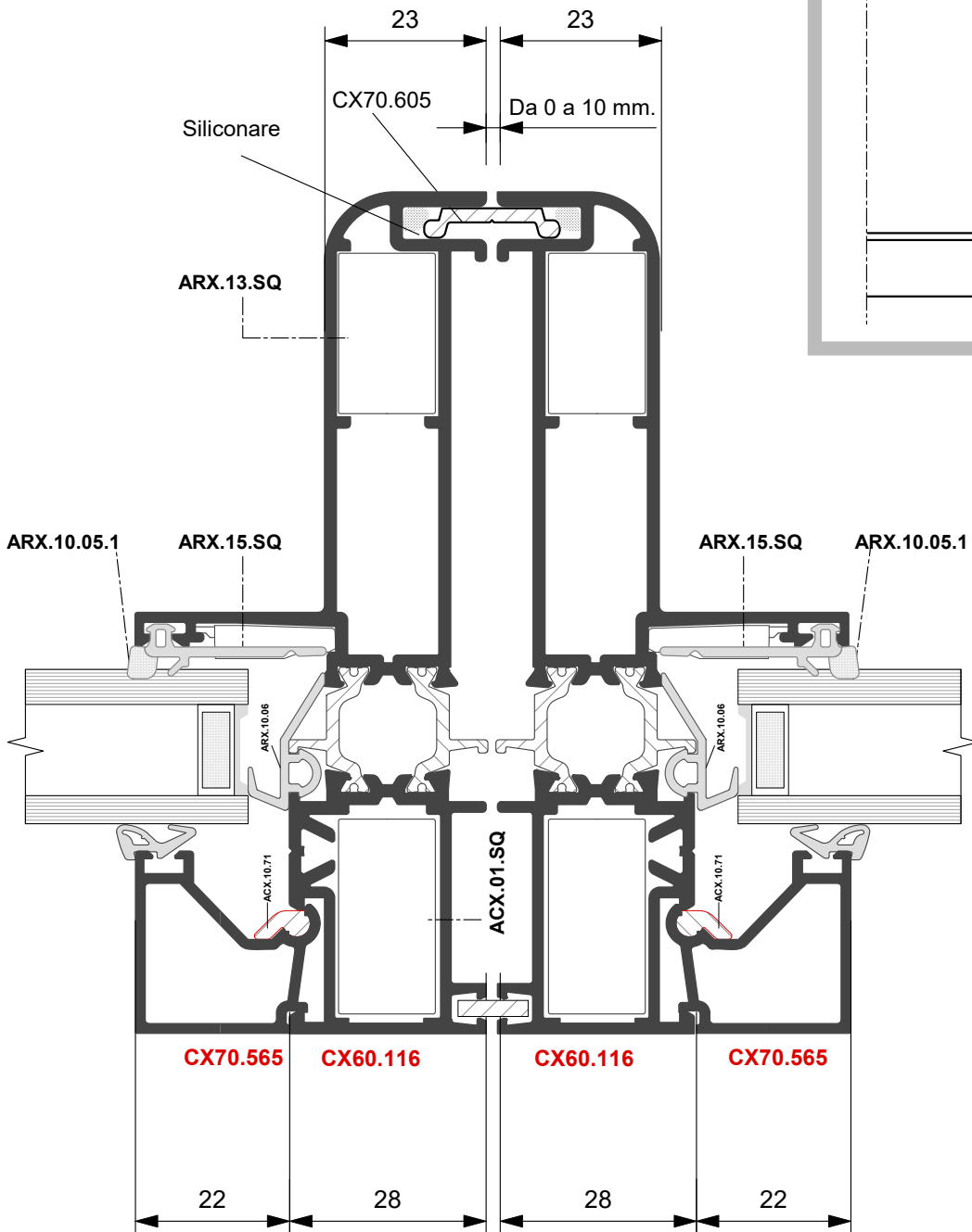
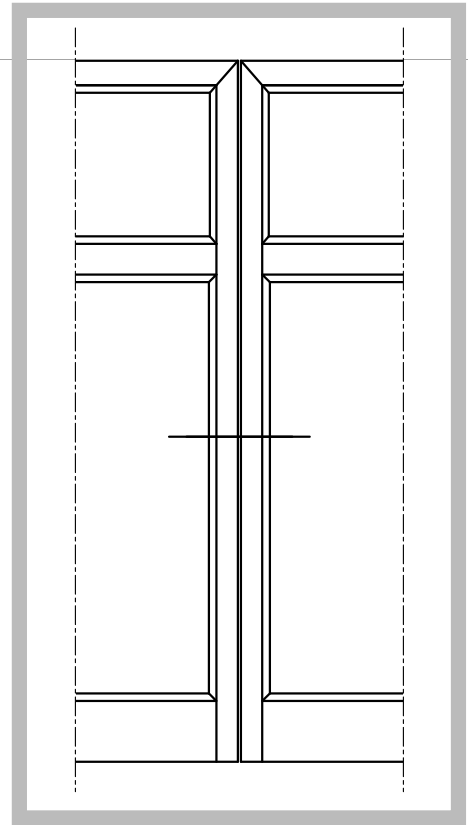



PORTA DI INGRESSO A 2 ANTE
Apertura esterna

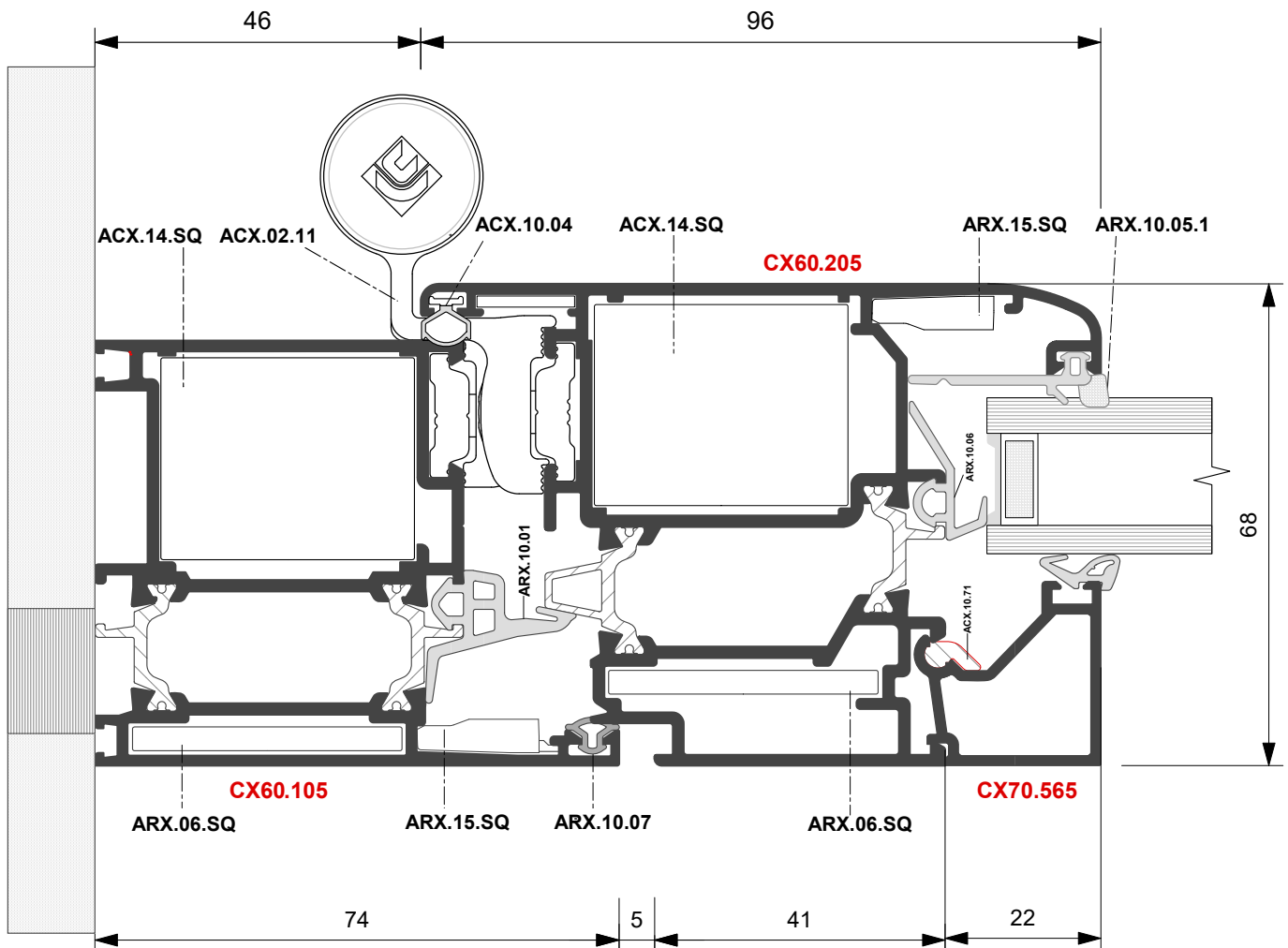
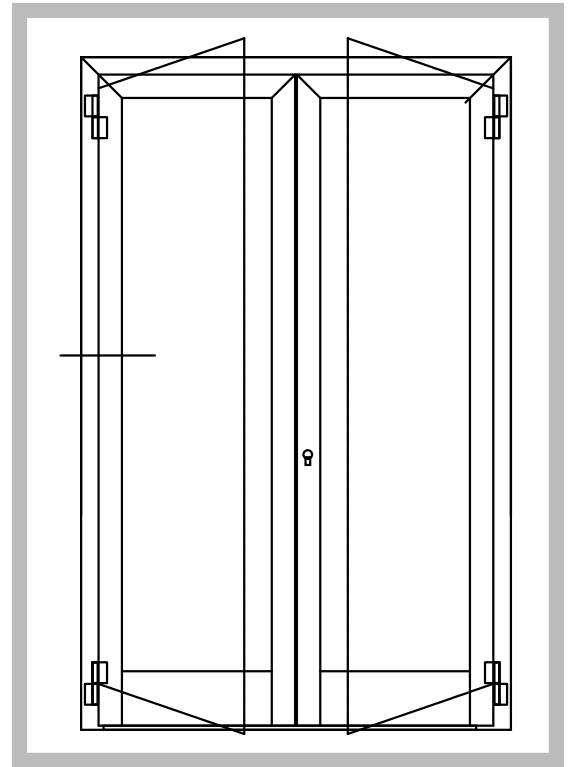



PORTA DI INGRESSO A 2 ANTE
Apertura esterna

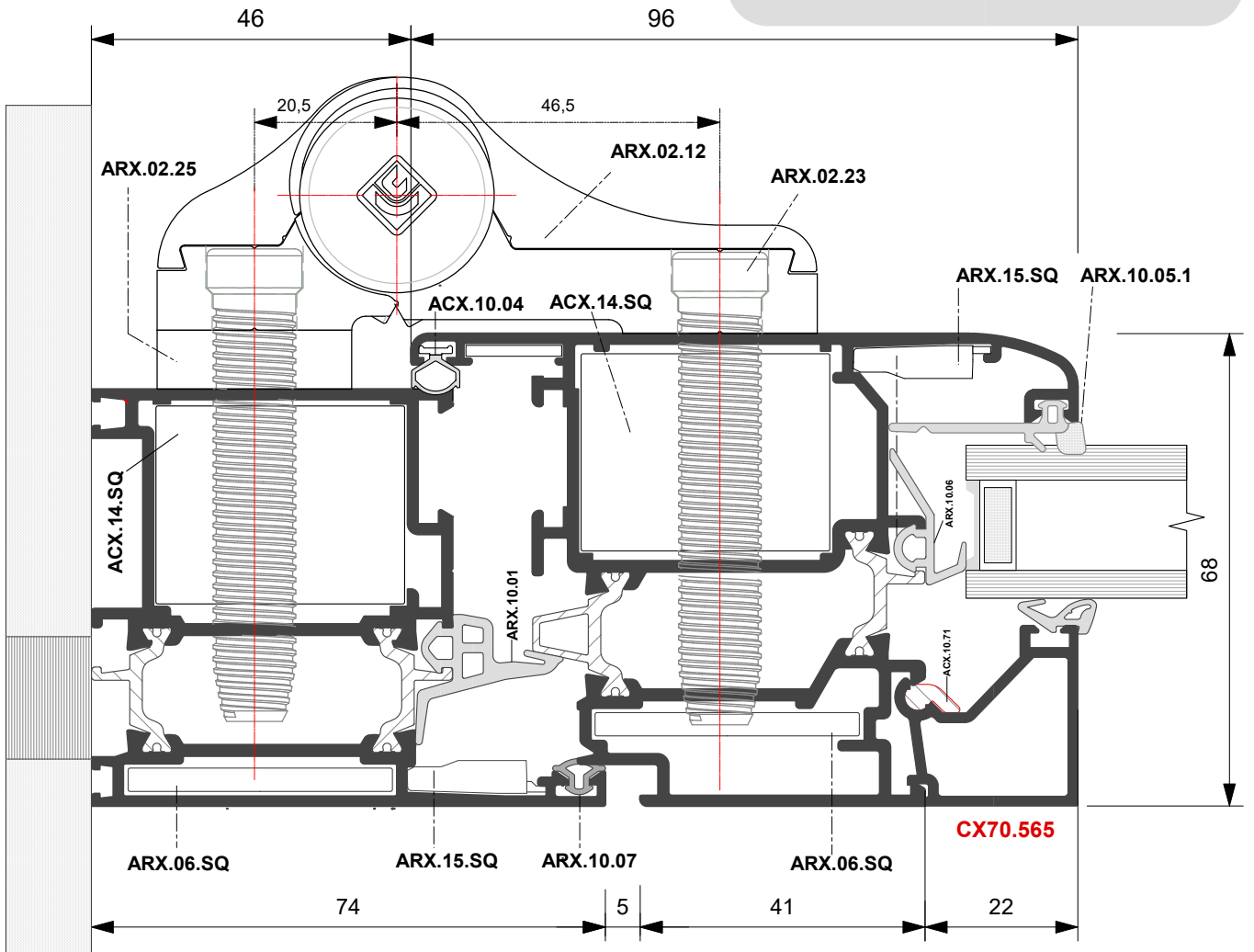
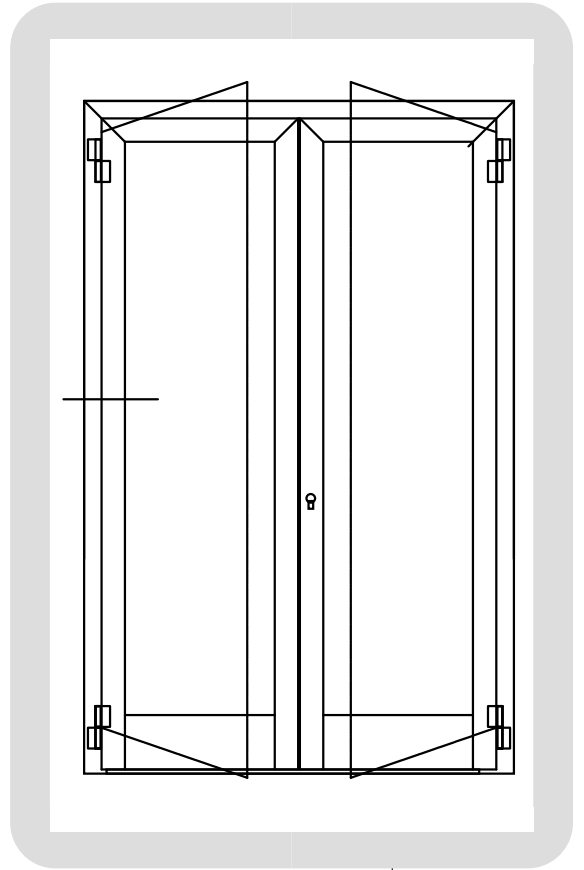



PORTA INGRESSO AD UNA ANTA
Apertura esterna

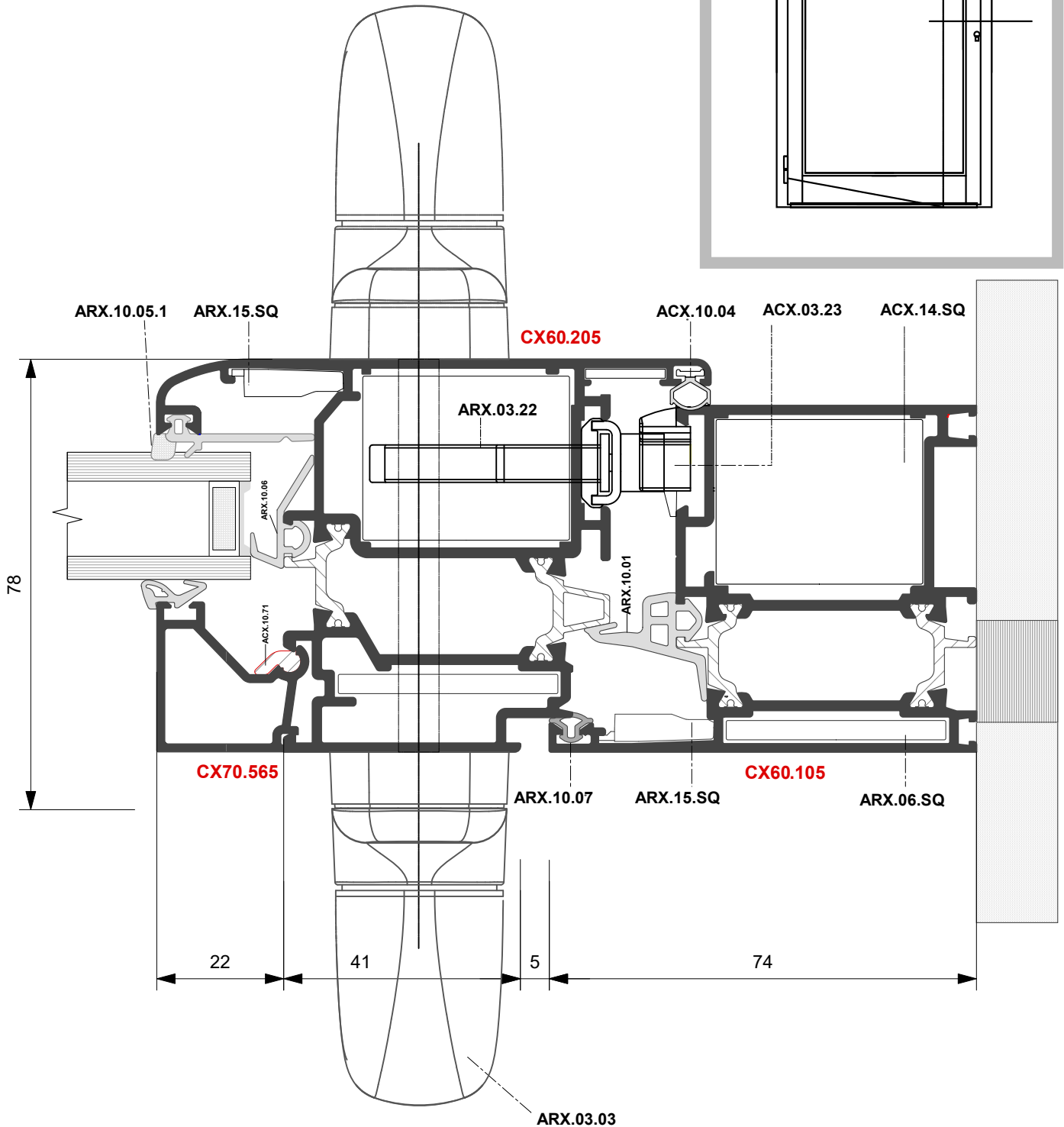
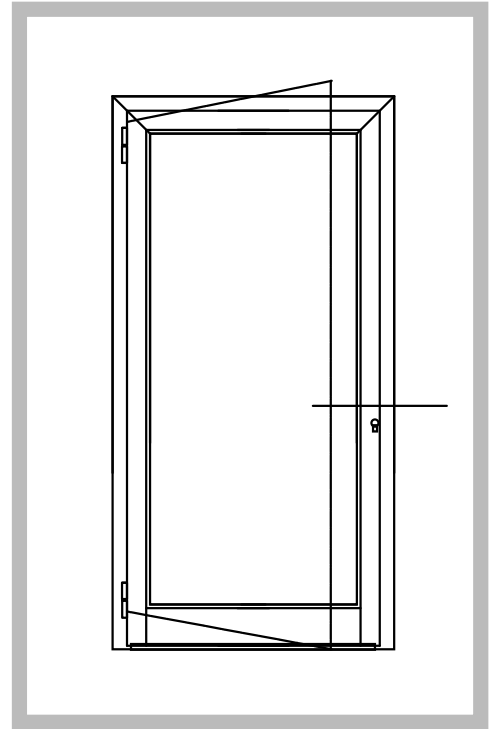

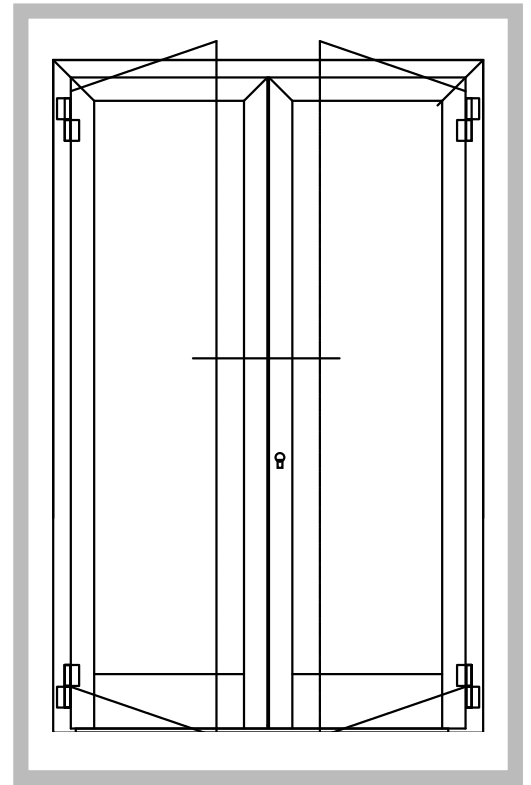
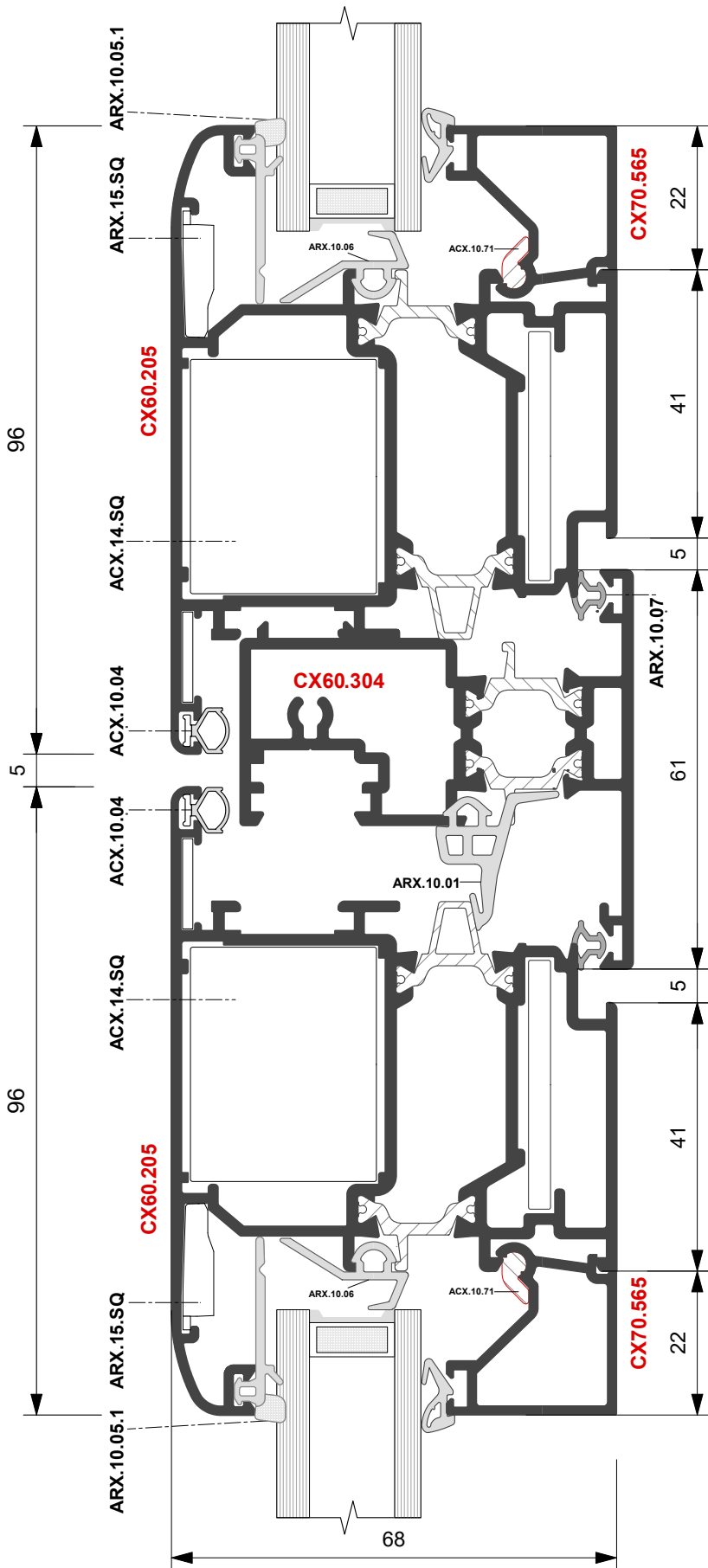



PORTA DI INGRESSO A 3 ANTE
Apertura esterna

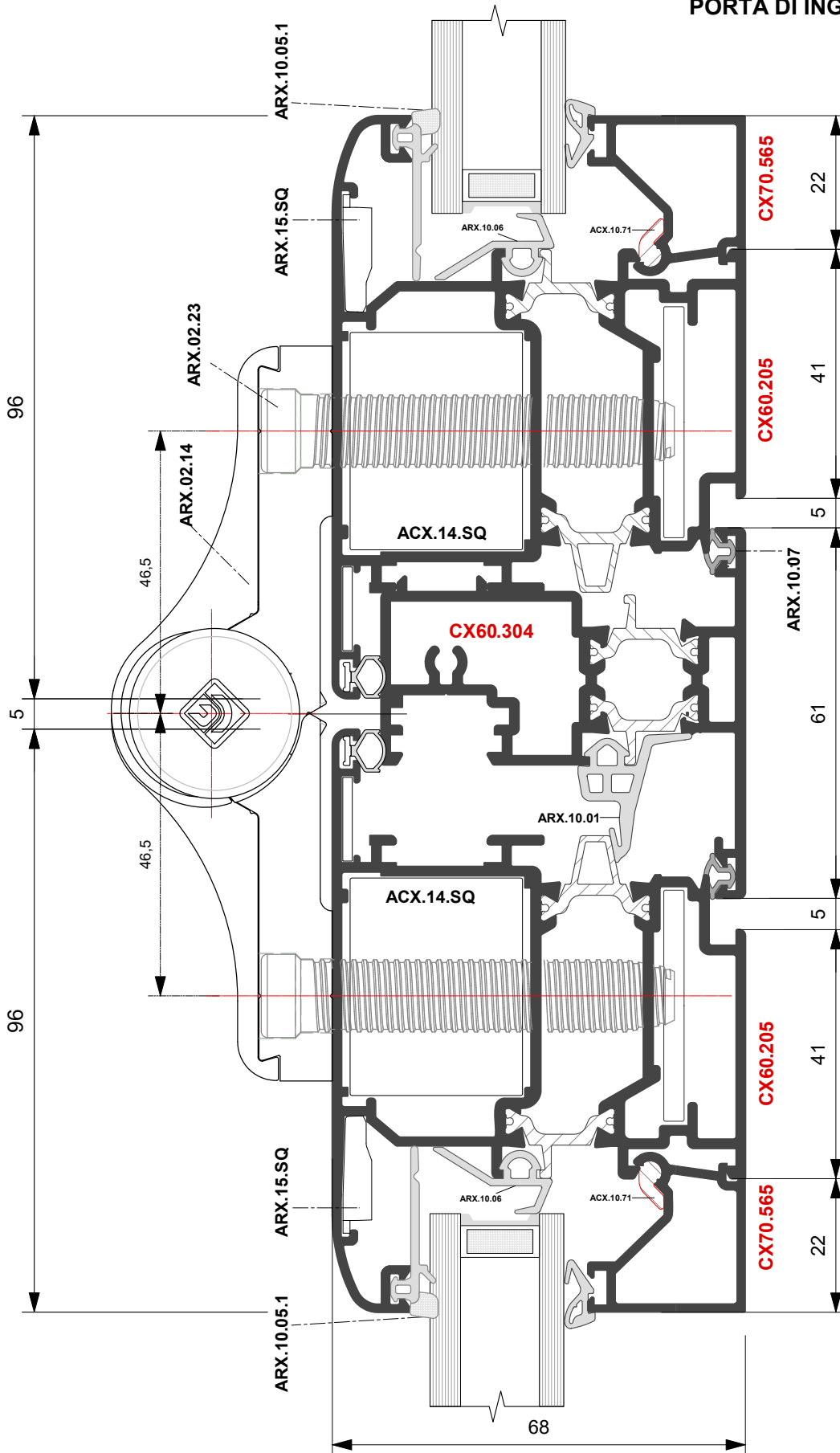



PORTA A DUE ANTE CON SOPRALUCE FISSO
Apertura esterna

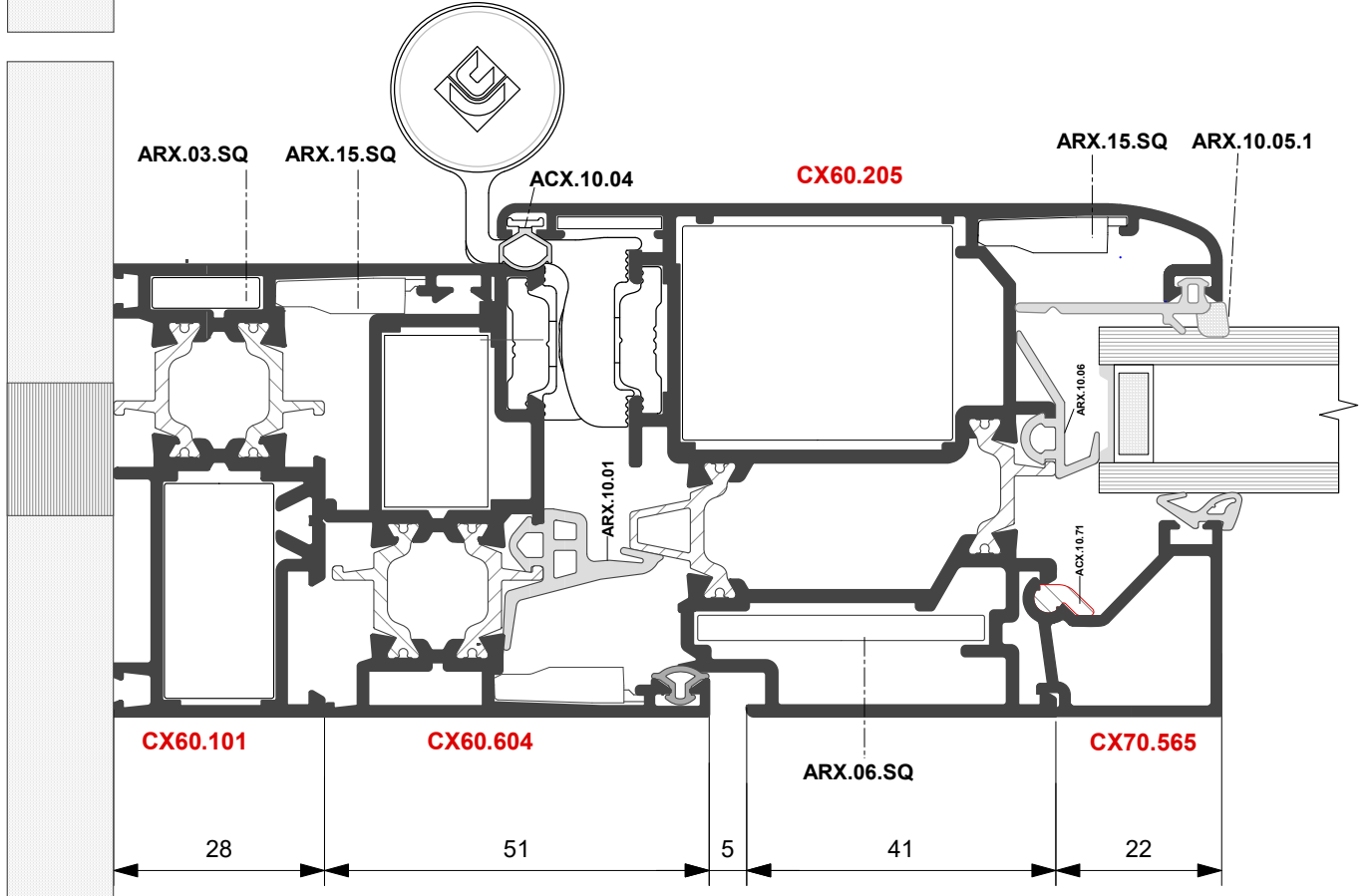
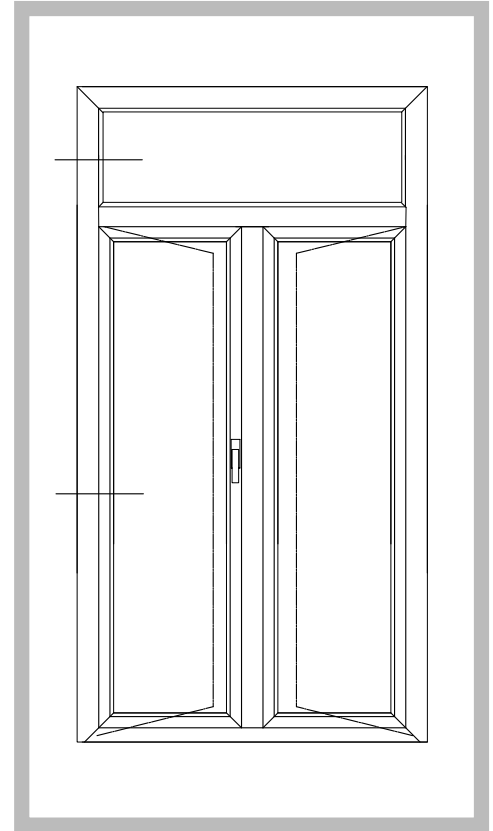
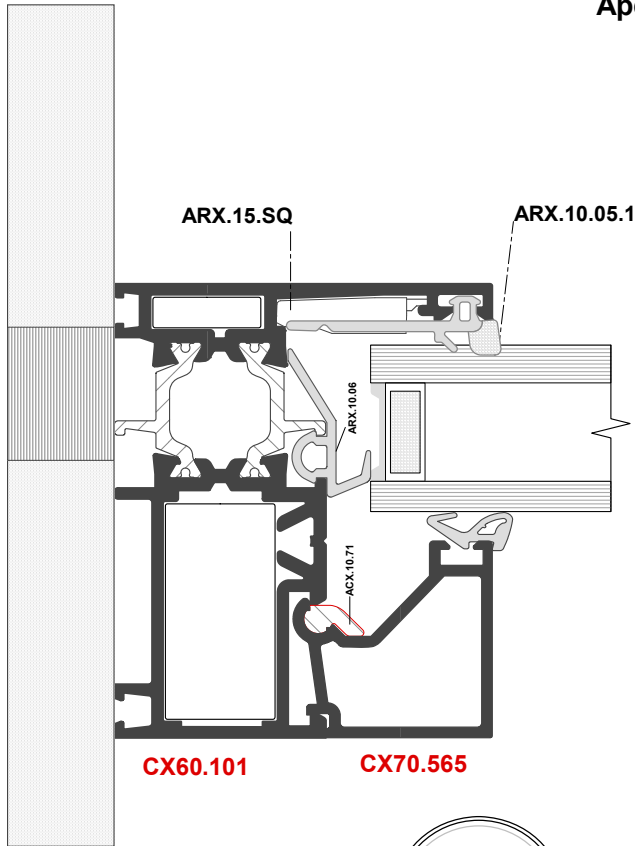



PORTA INGRESSO A DUE ANTE
Apertura interna

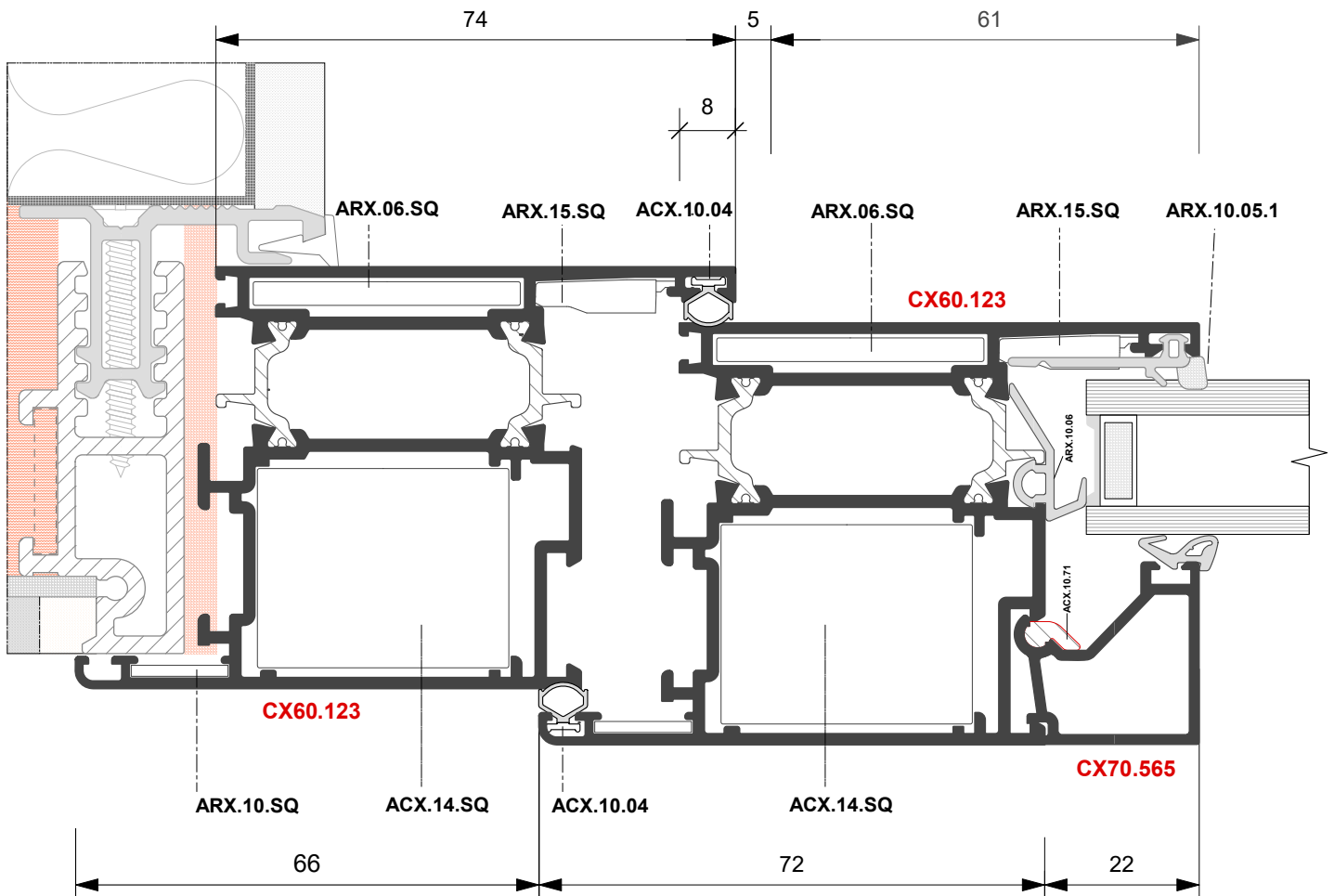
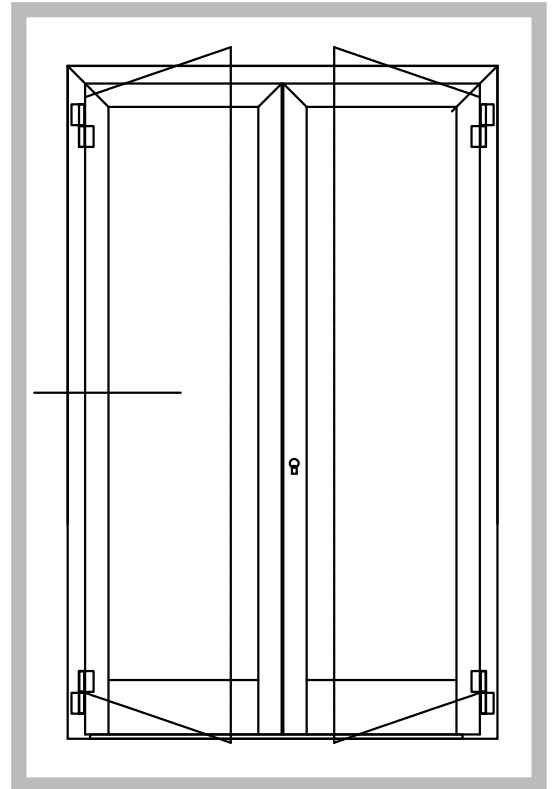



PORTA INGRESSO A DUE ANTE
Apertura interna

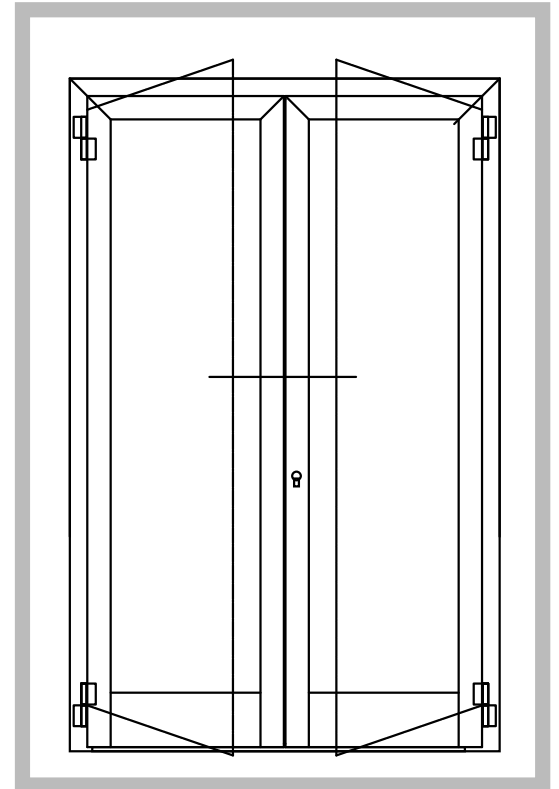
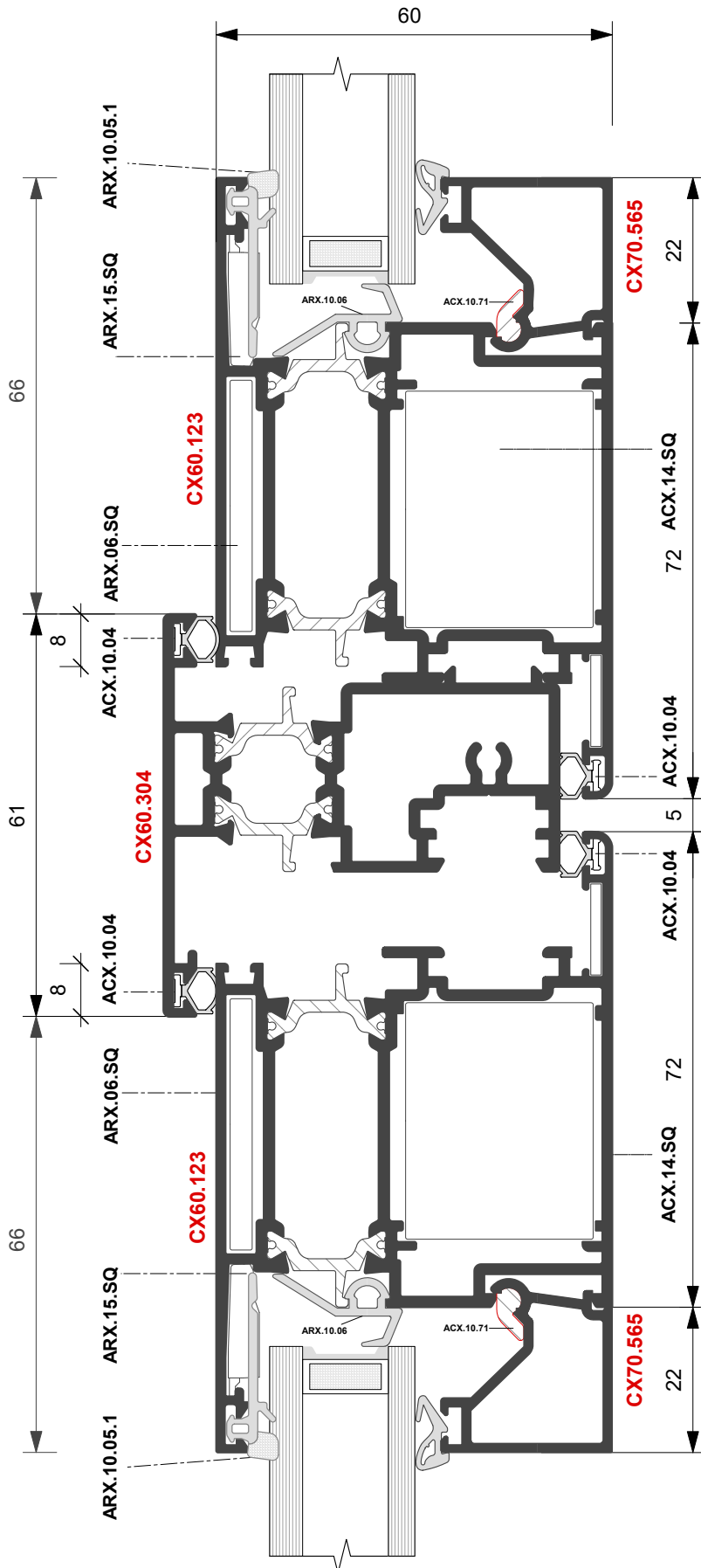



FINESTRA MONOBLOCCO

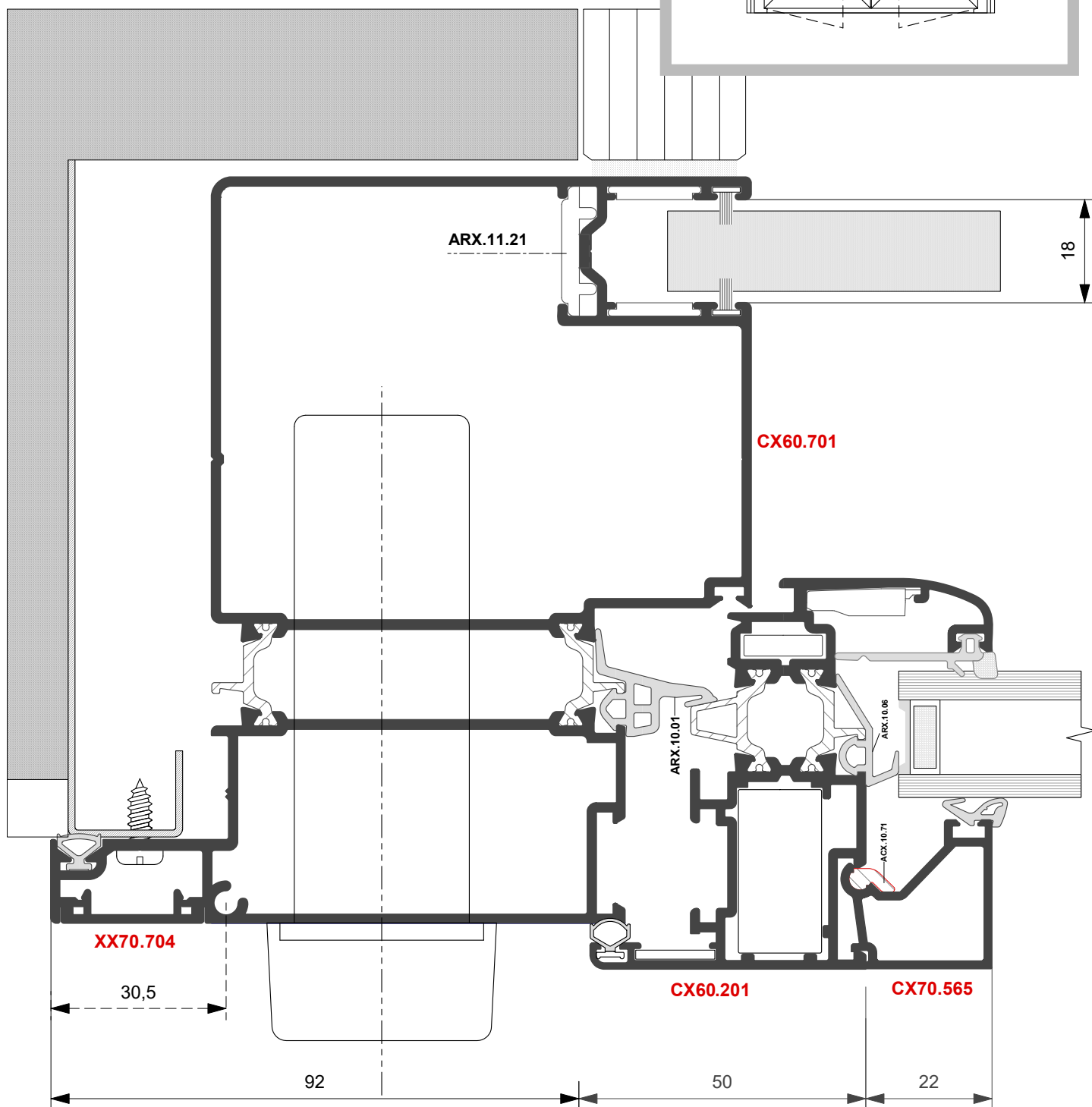
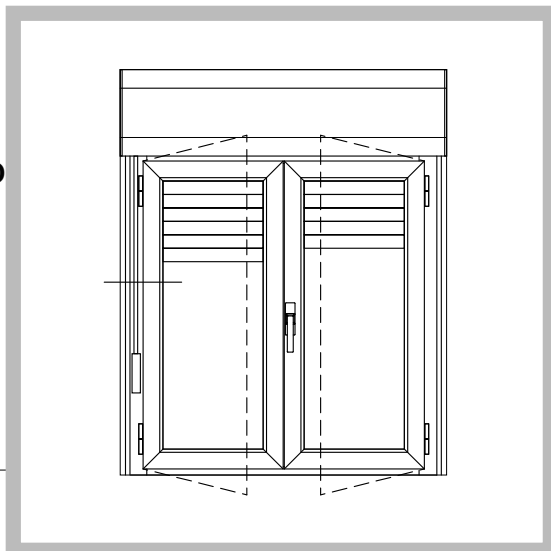



FINESTRA MONOBLOCCO

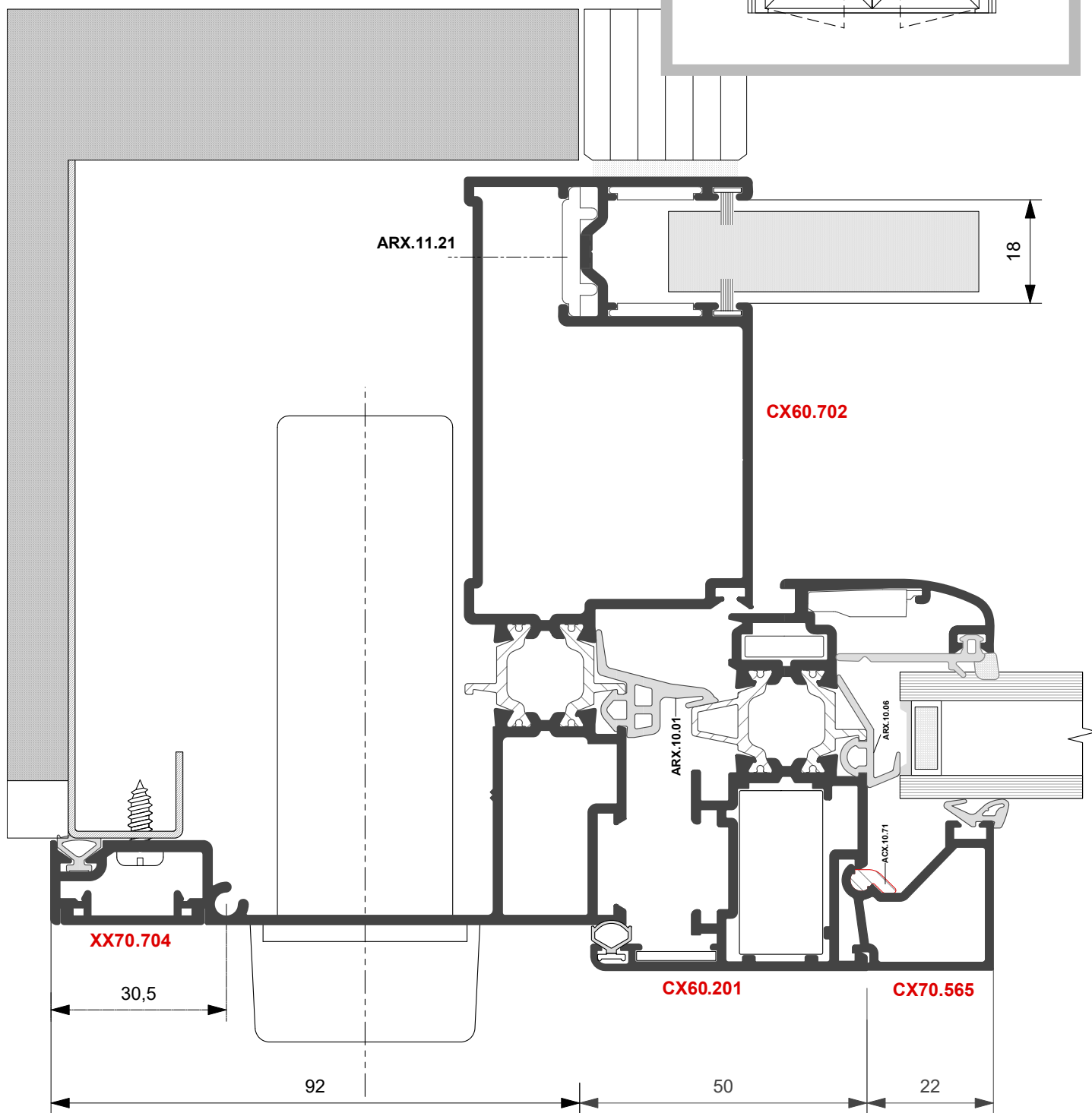
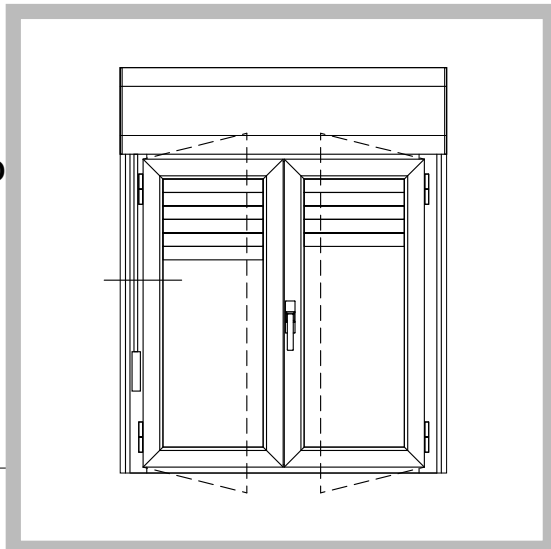



FINESTRA MONOBLOCCO

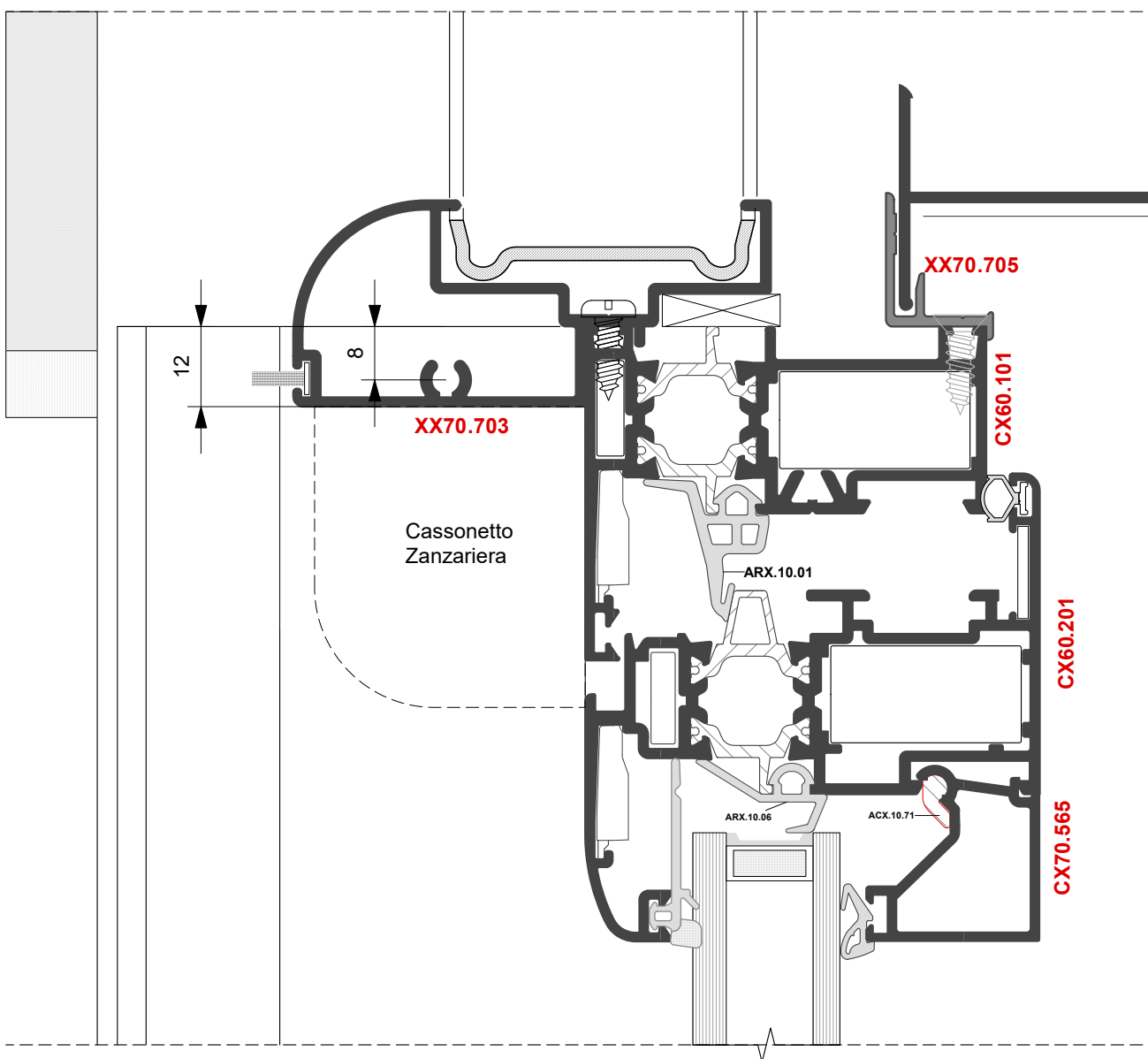
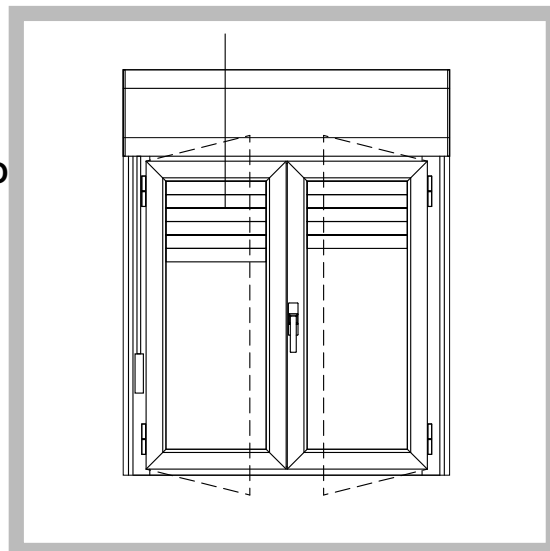



FINESTRA MONOBLOCCO

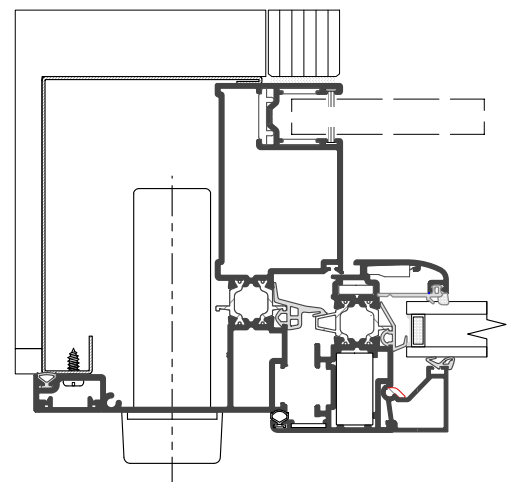
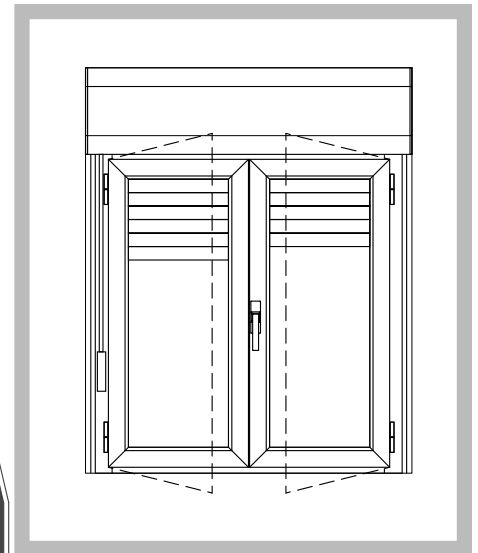
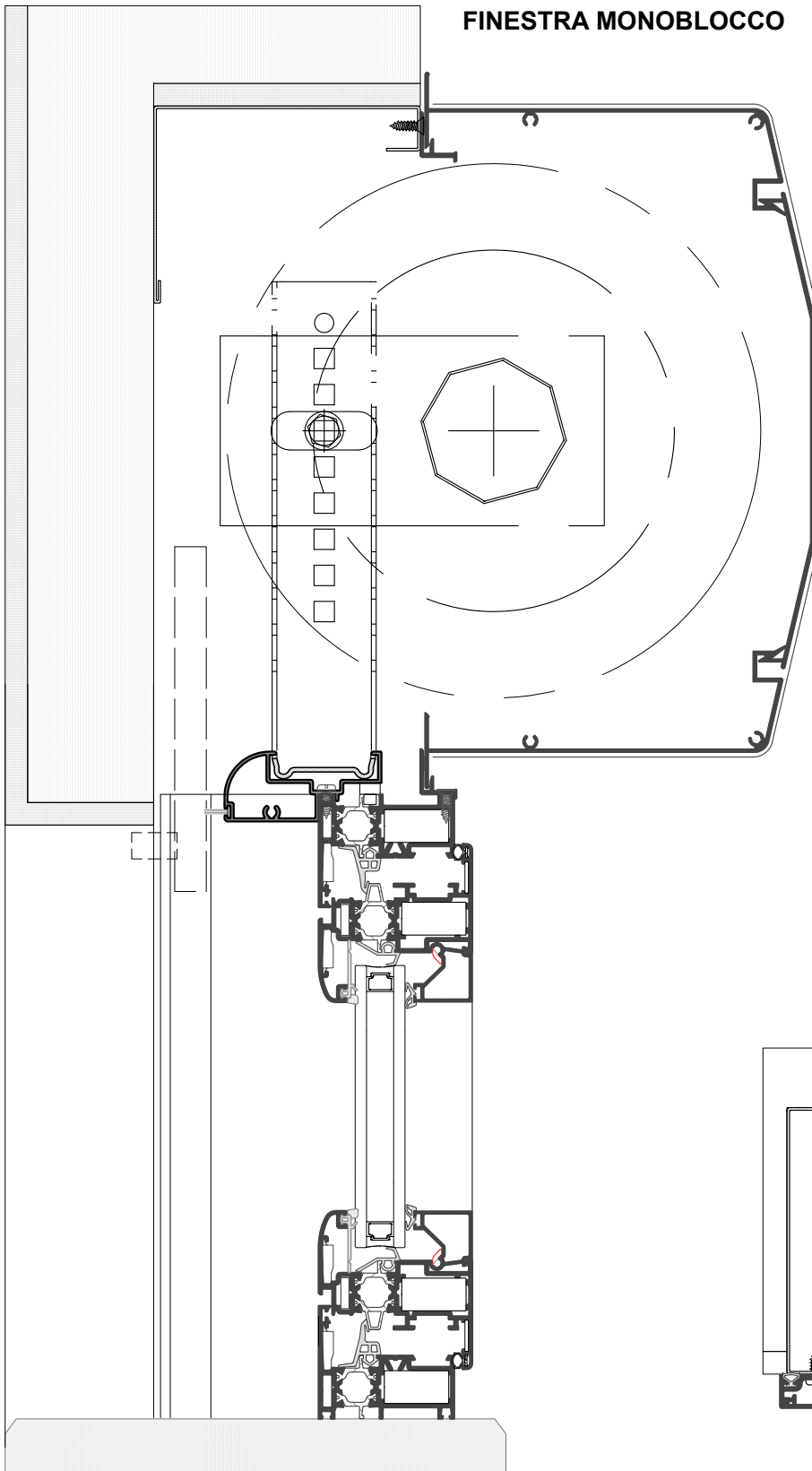



FINESTRA A DUE ANTE

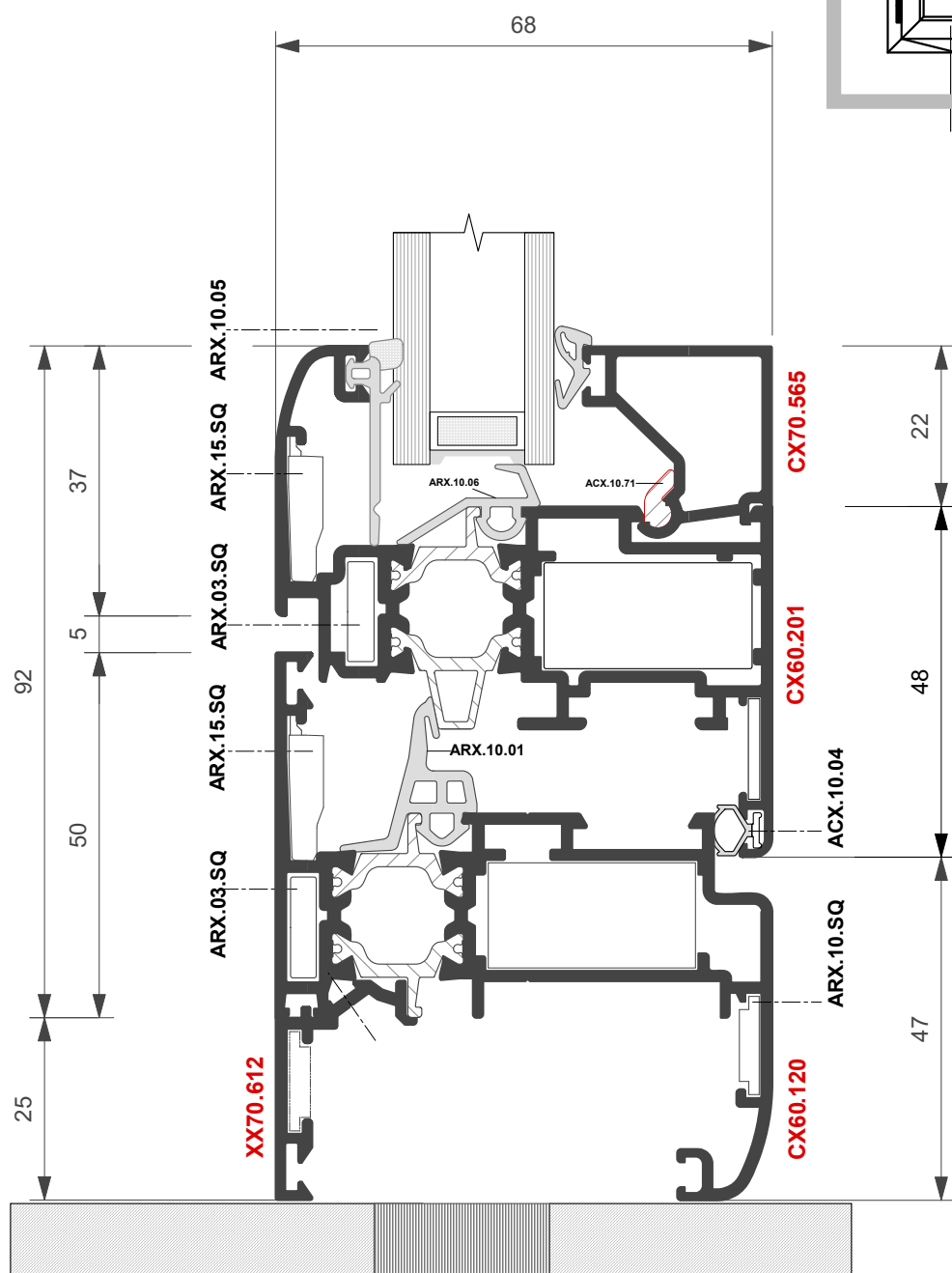
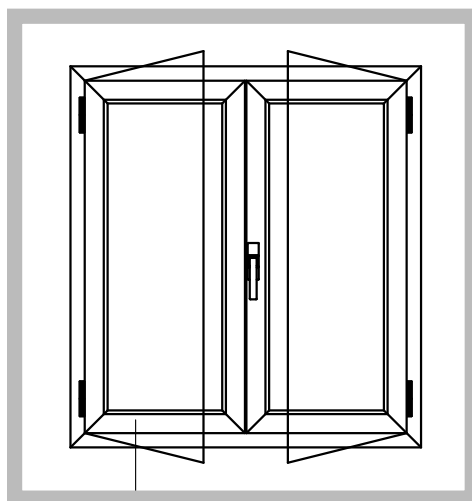



FINESTRA A DUE ANTE
con scuretto

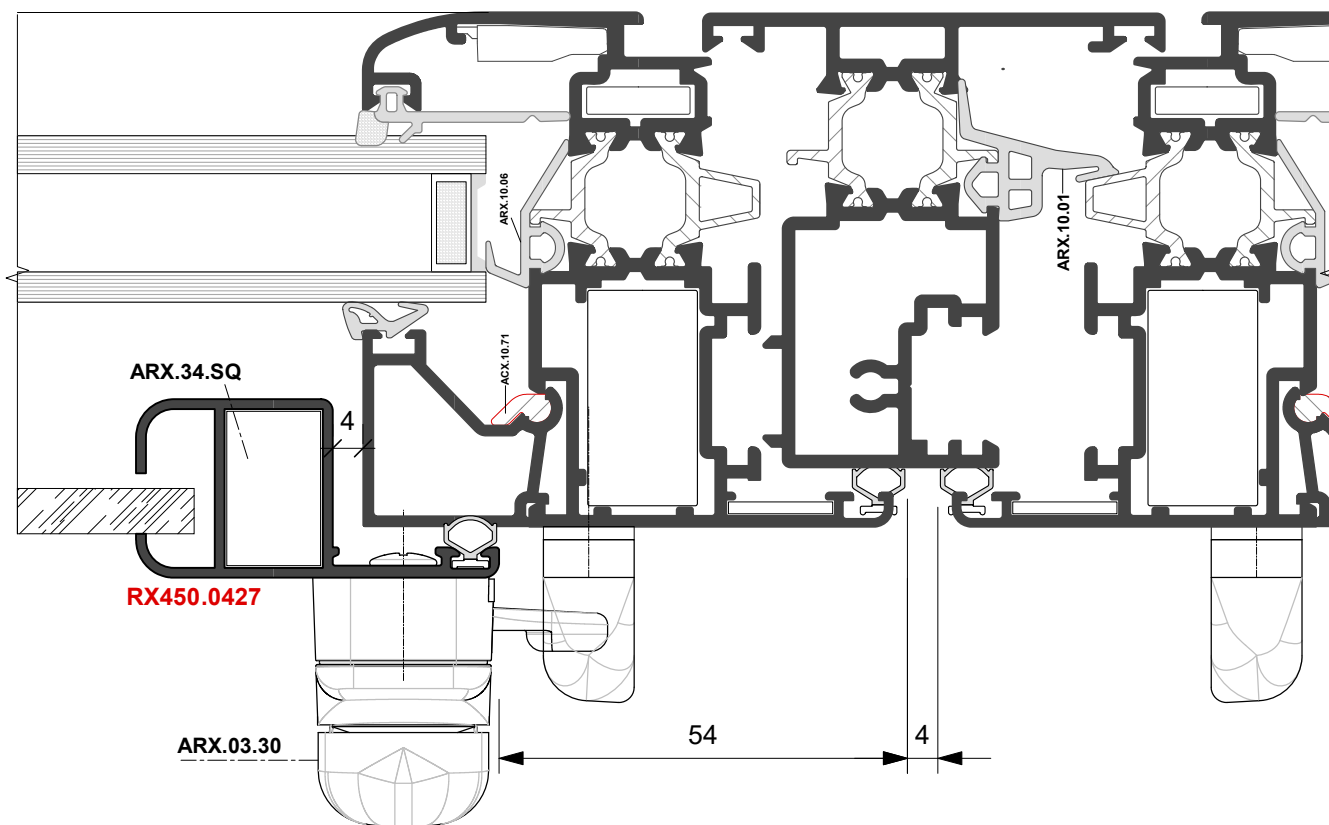
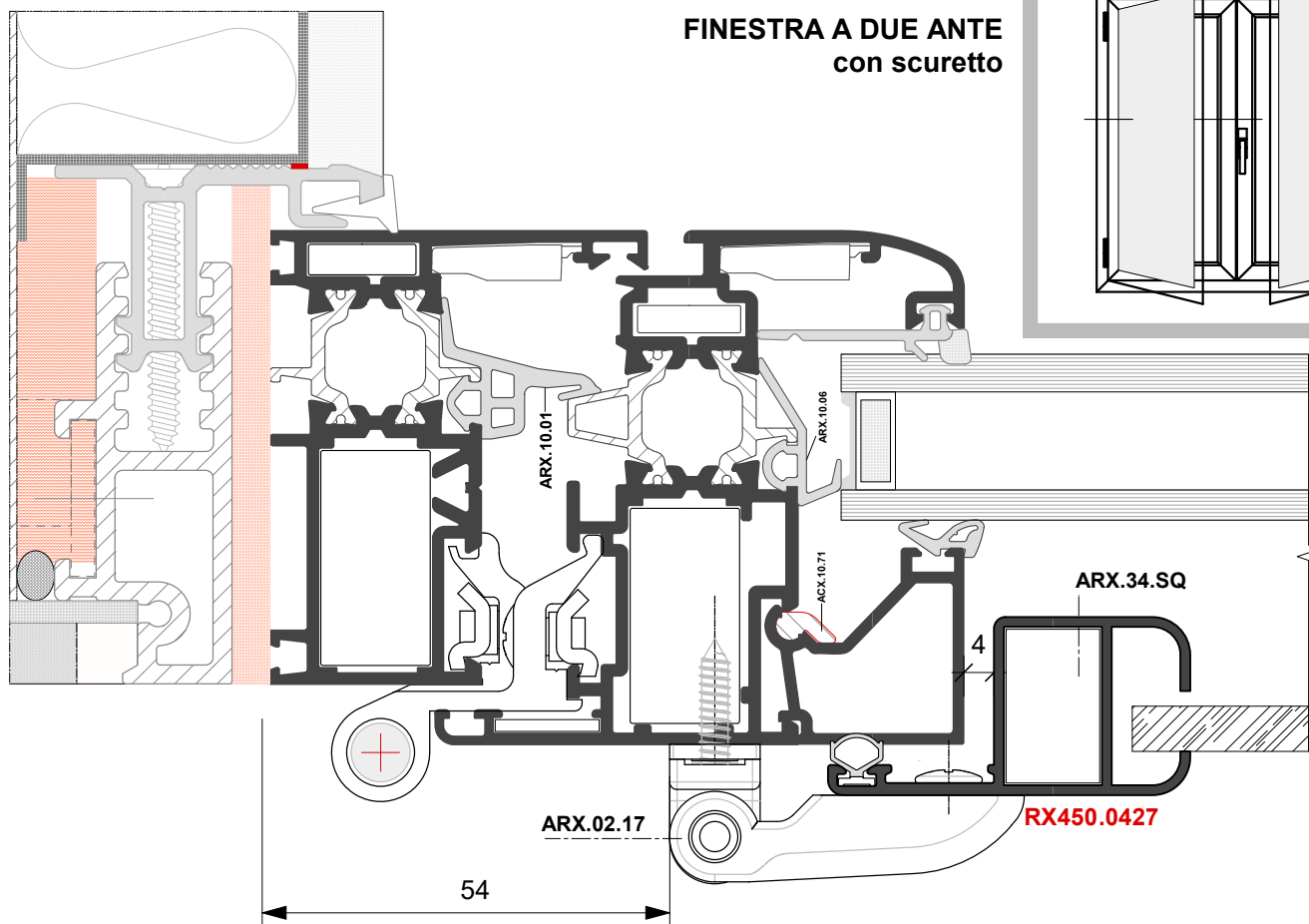
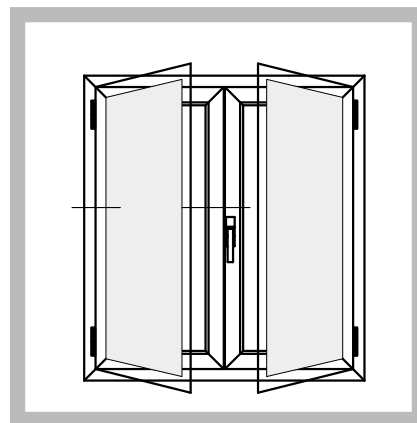

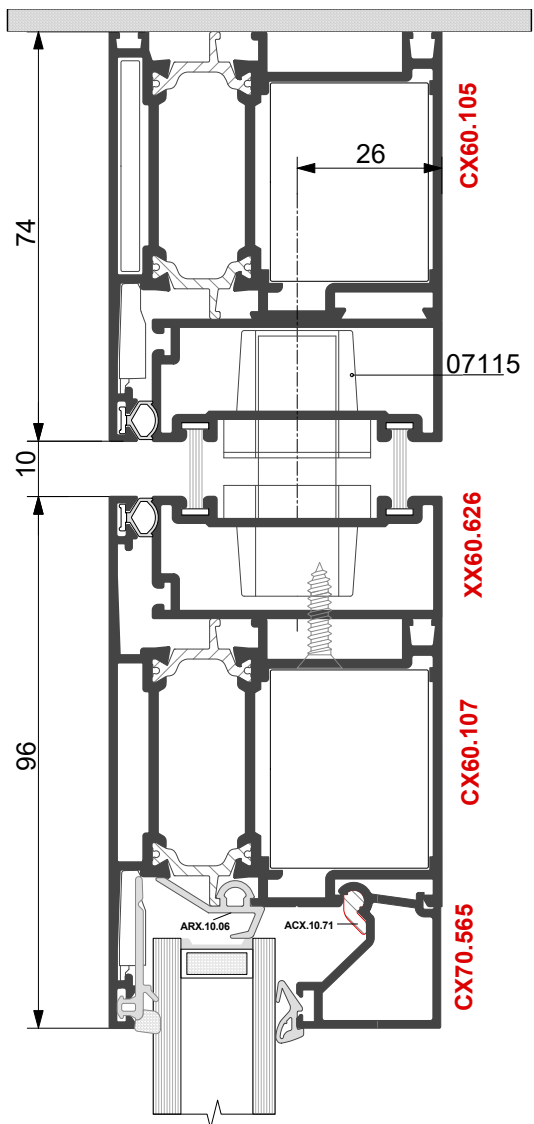

PORTE A VENTO
CARDINE E CHIUDIORTA
PORTE VA E VIENI

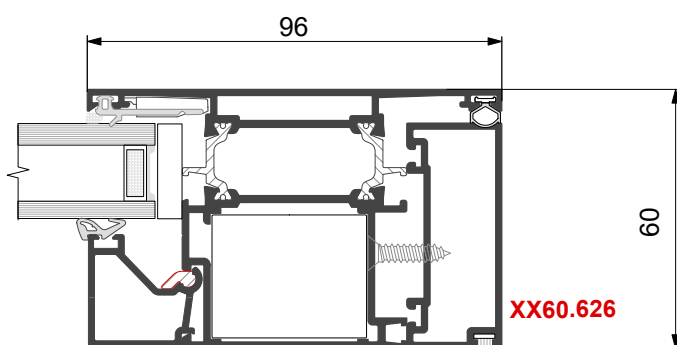
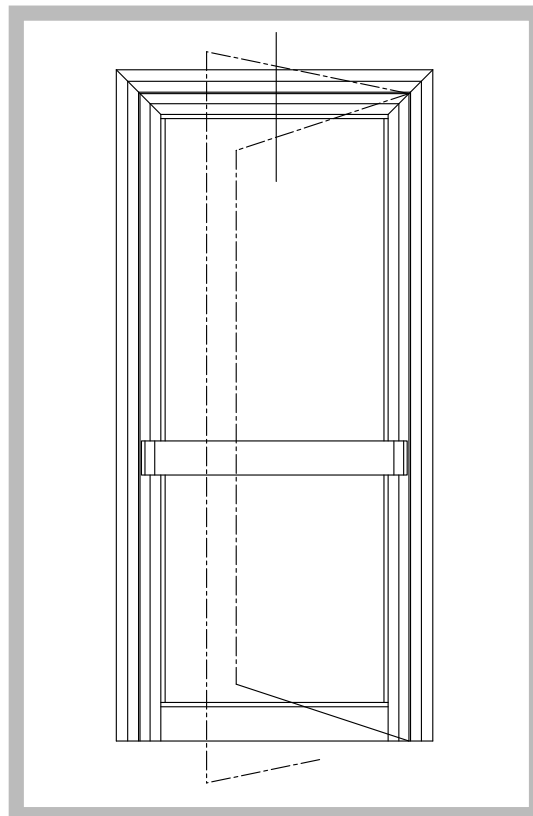

PORTE A SCORRERE CON FISSI

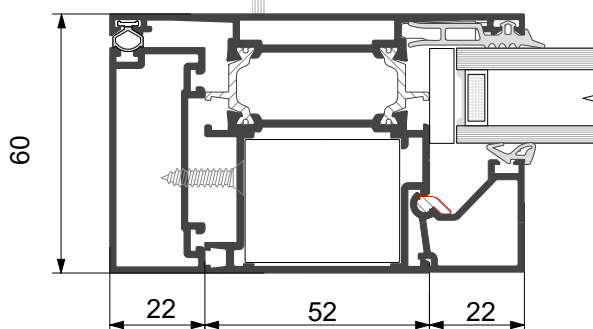



PORTE A VENTO
CARDINE E CHIUDIORTA - PORTE VA E VIENI

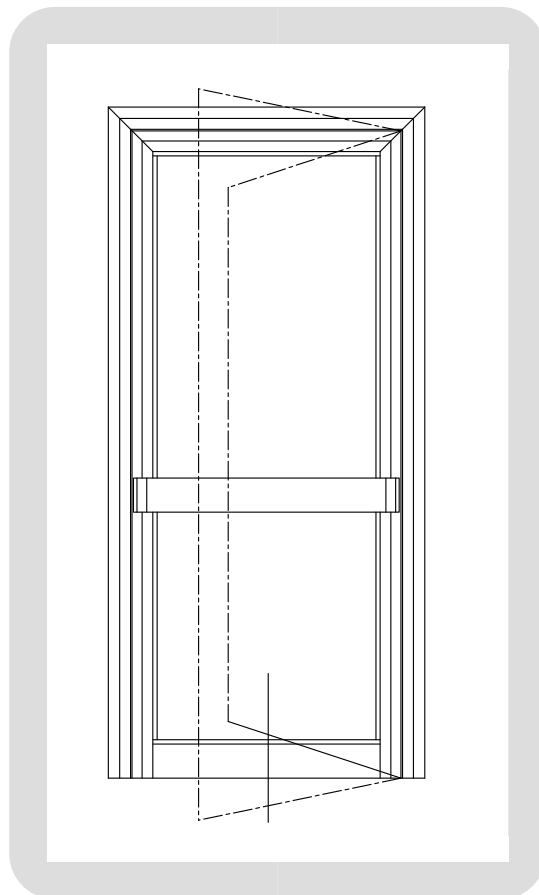
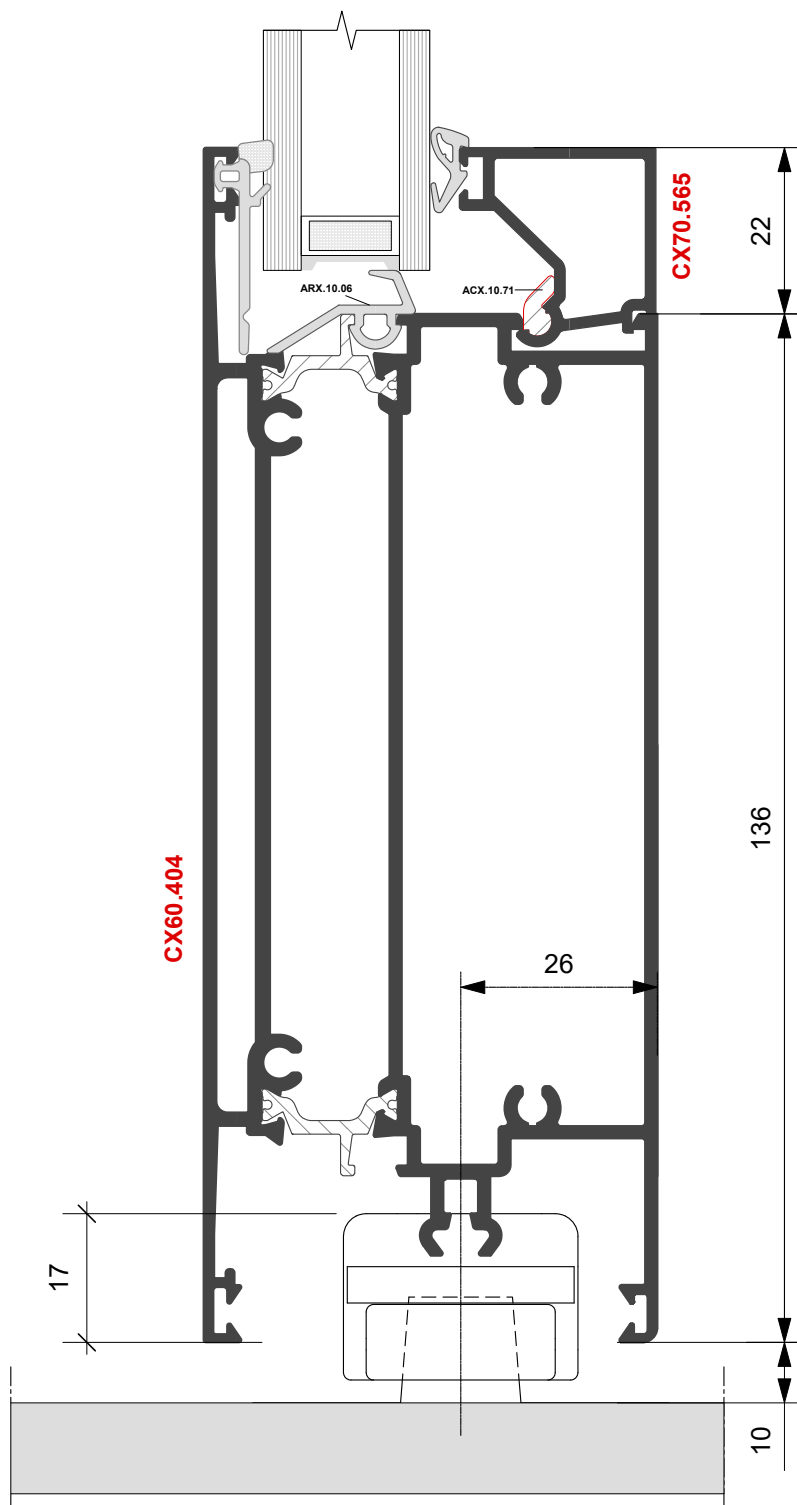

Chiudiporta a pavimento Art. 60220 - Art. 60221 (90°) - Art. 60222 (105°)

N.B. I CODICI INDICATI SONO RIFERITI A PRODOTTI DELLA CISA S.p.A.



PORTE A VENTO A 2 ANTE

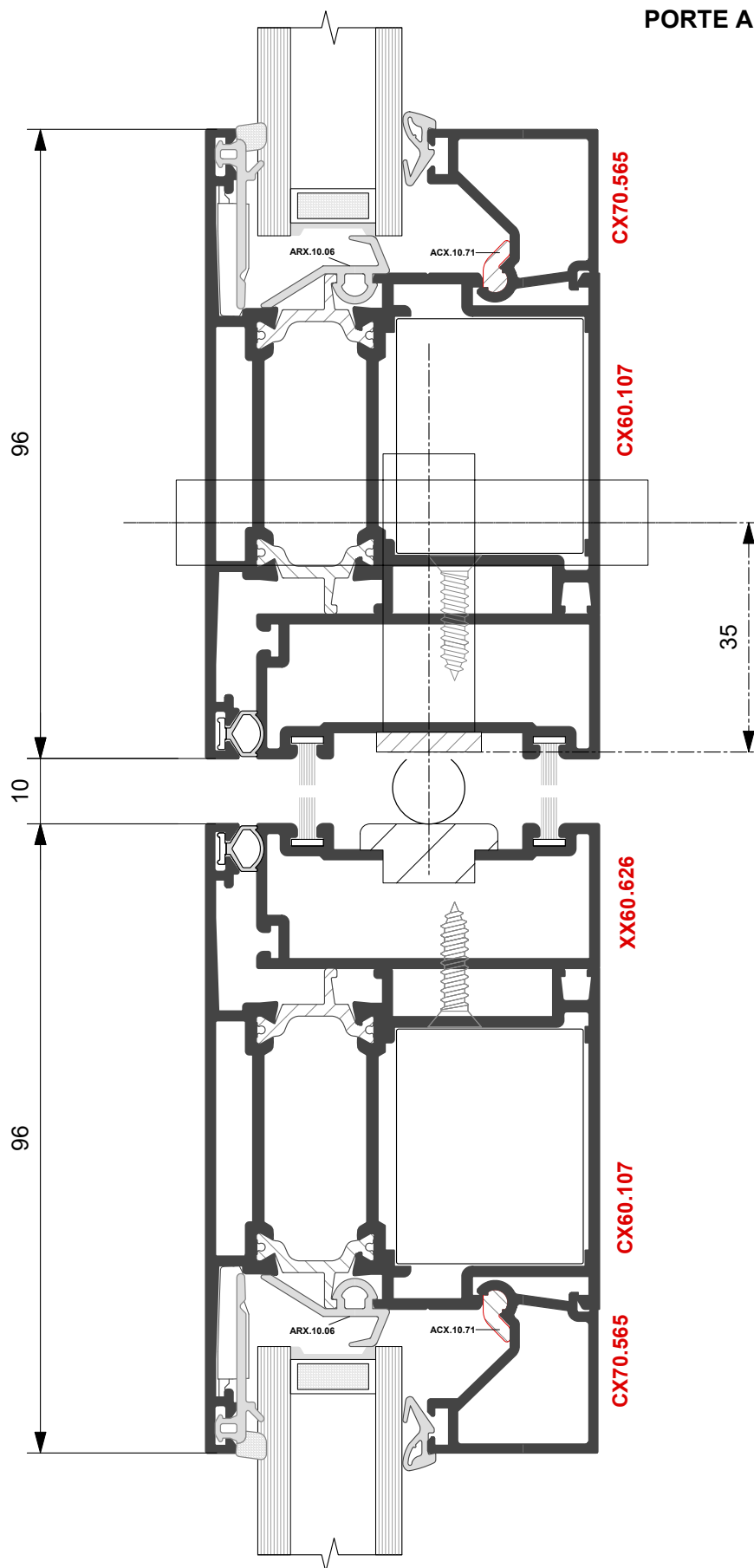

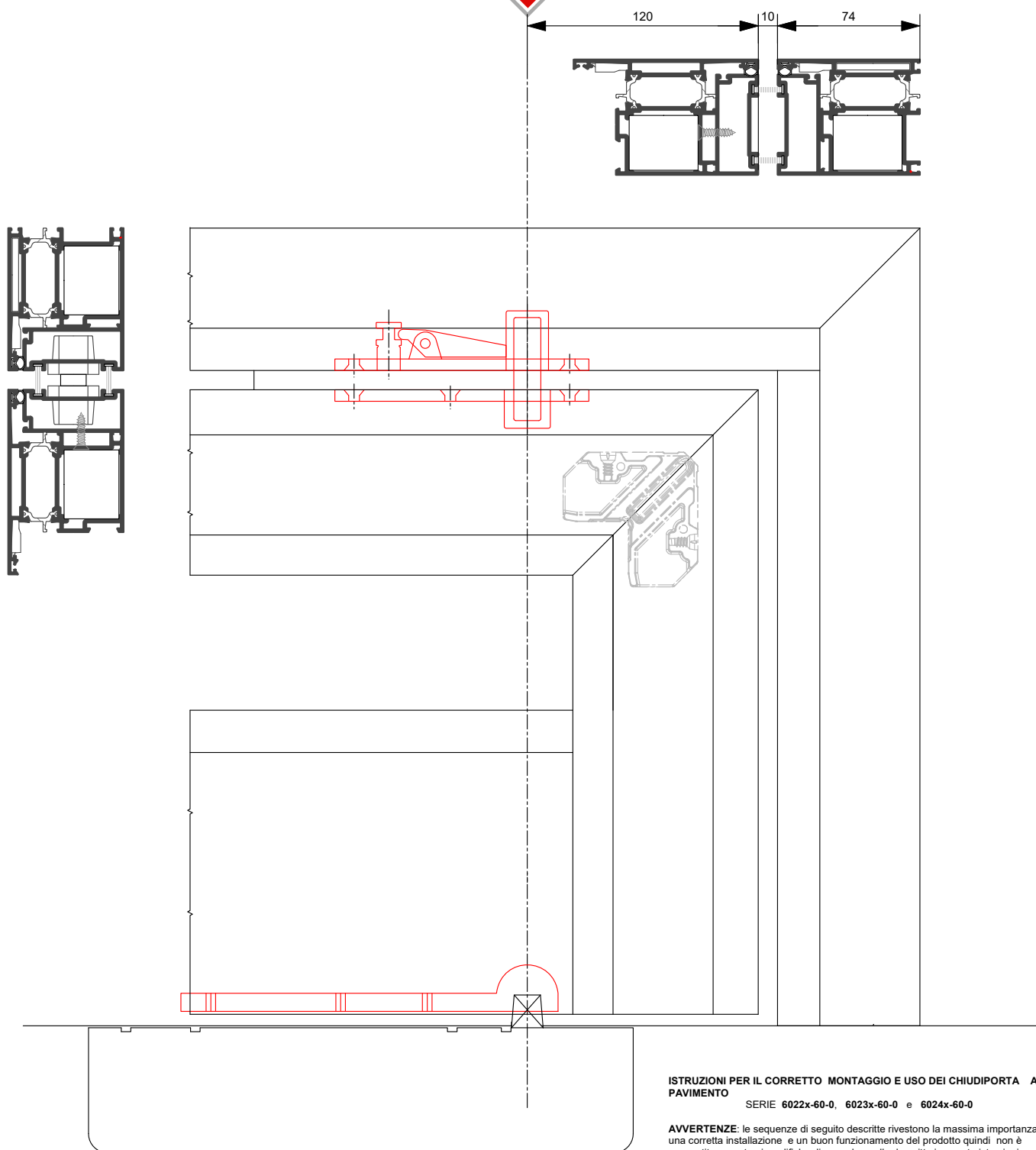

ISTRUZIONI PER IL CORRETTO MONTAGGIO E USO DEI CHIUDIPIORTA A PAVIMENTO

SERIE 6022x-60-0, 6023x-60-0 e 6024x-60-0

AVVERTENZE: le sequenze di seguito descritte rivestono la massima importanza per una corretta installazione e un buon funzionamento del prodotto quindi non è consentito apportarvi modifiche diverse da quelle descritte in queste istruzioni. Questo prodotto va installato su porte con le seguenti caratteristiche:
 serie 6022x-60-0 100 kg. di massa max e 900 mm di larghezza max
 serie 6023x-60-0 100 kg. di massa max e 1100 mm di larghezza max
 serie 6024x-60-0 200 kg. di massa max e 1300 mm di larghezza max

PREPARAZIONE:

- 1) Installare le cerniere sulla porta, tracciare il centro di queste sul pavimento e rispetto a tale centro eseguire la sede incassata per la scatola in lamiera contenente il chiudiporta.
- 2) Sfilare il chiudiporta ed ancorare la scatola che dovrà essere solidale con il pavimento ed incassata 1mm sotto di esso.

MONTAGGIO:

- 3) Inserire il chiudiporta all'interno della scatola, assicurarsi che la tacca presente sul perno quadro sia in corrispondenza dell'asse principale del chiudiporta.
- 4) Avvitare completamente la valvola per la regolazione della velocità di chiusura (vedi etichetta istruzione sul chiudiporta).
- 5) Ruotare il perno quadro di circa 60° e procedere al montaggio della porta (lubrificare con grasso i perni cerniera).
- 6) Svitare la valvola per la regolazione della velocità di chiusura e chiudere la porta.



Serie **SLIM**
FINESTRA A DUE ANTE

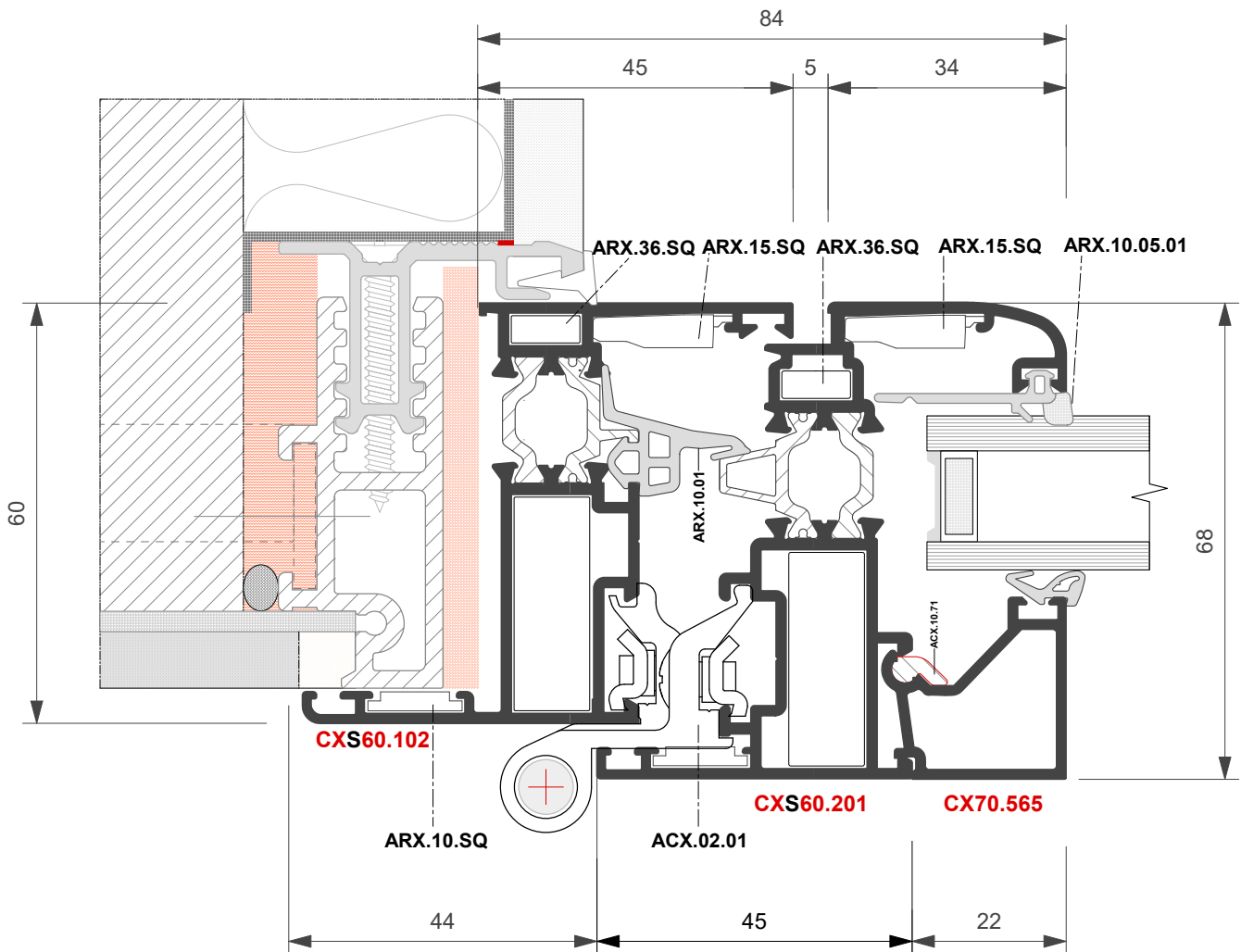
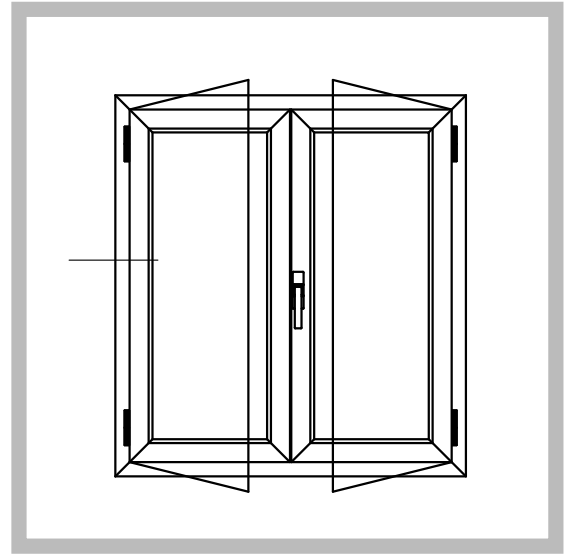



Serie **SLIM**
FINESTRA A DUE ANTE

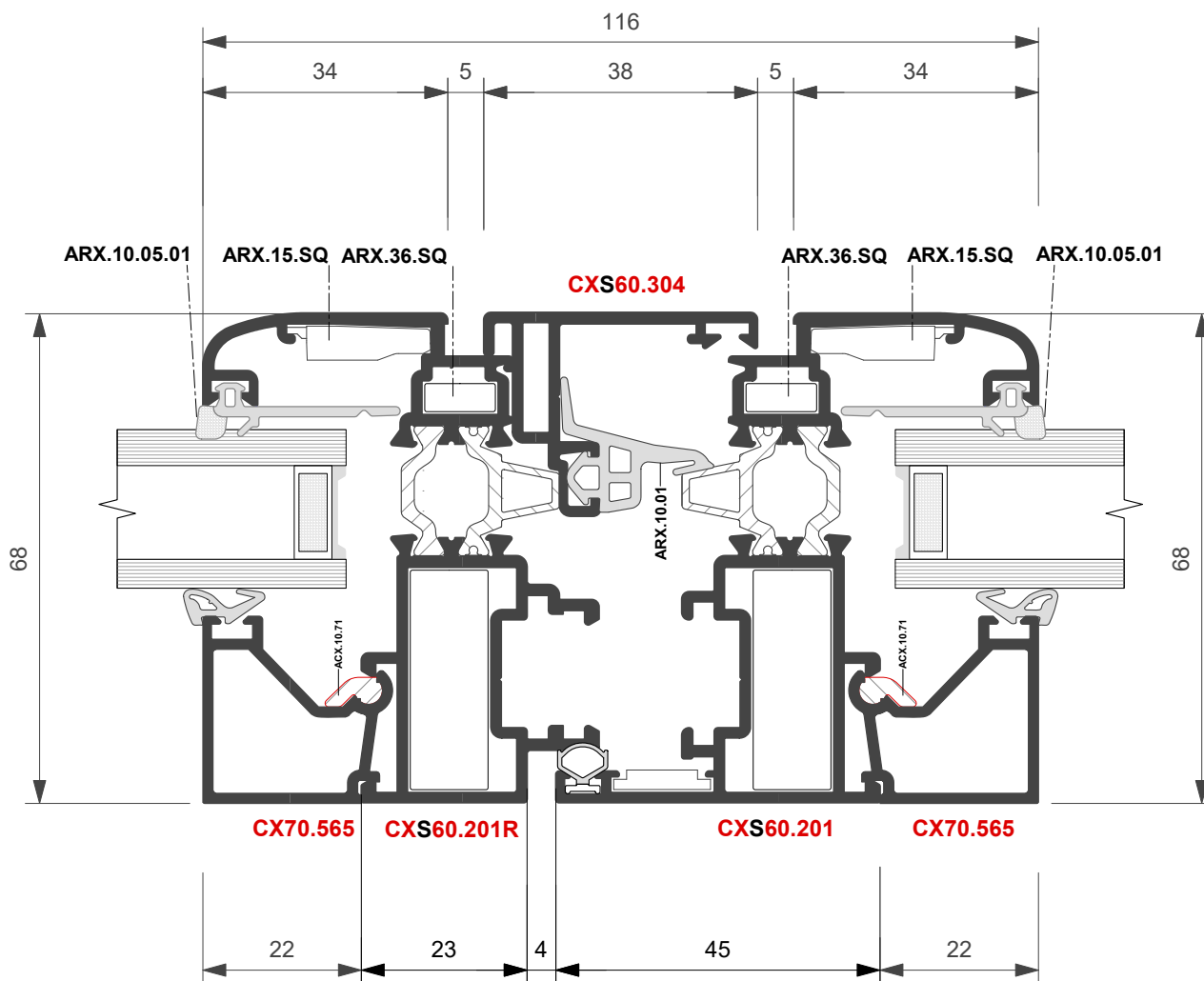
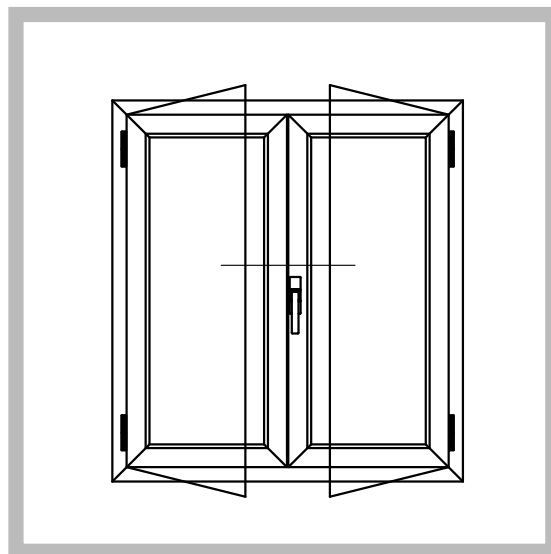



FINESTRA A DUE ANTE
Apertura esterna

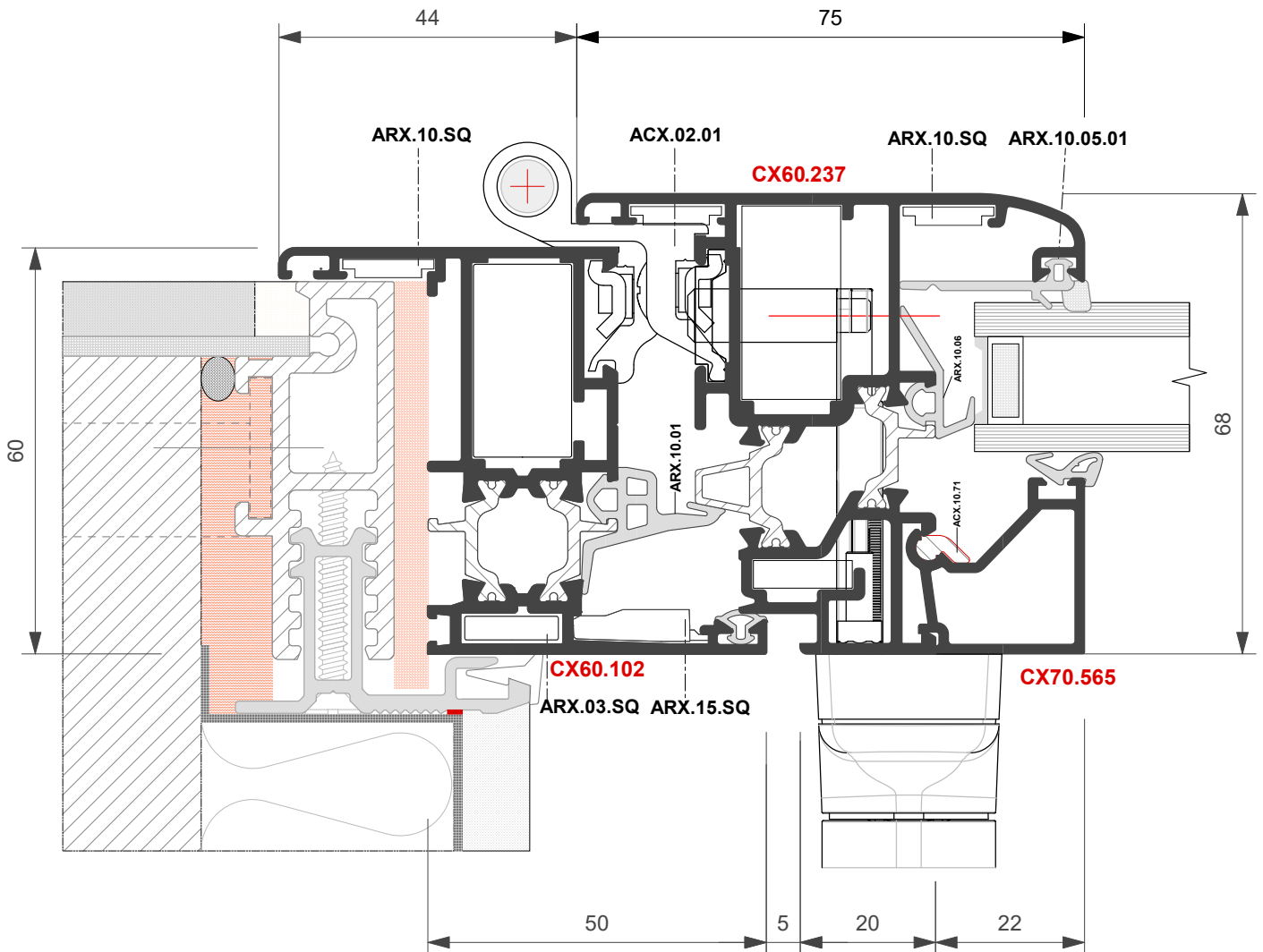
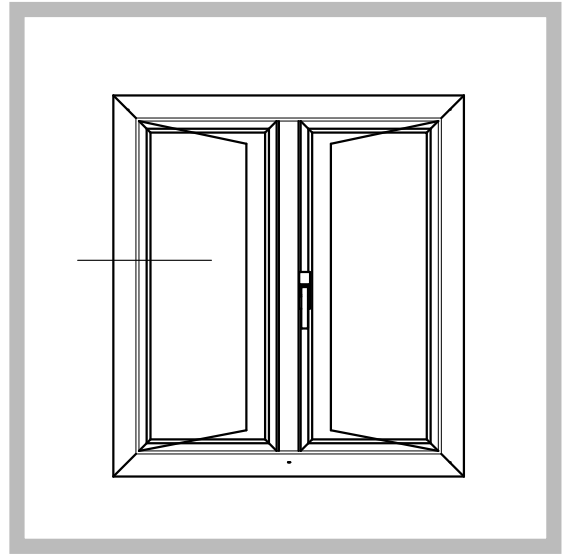



FINESTRA A DUE ANTE
Cerniera a scomparsa
Salto 10 mm.

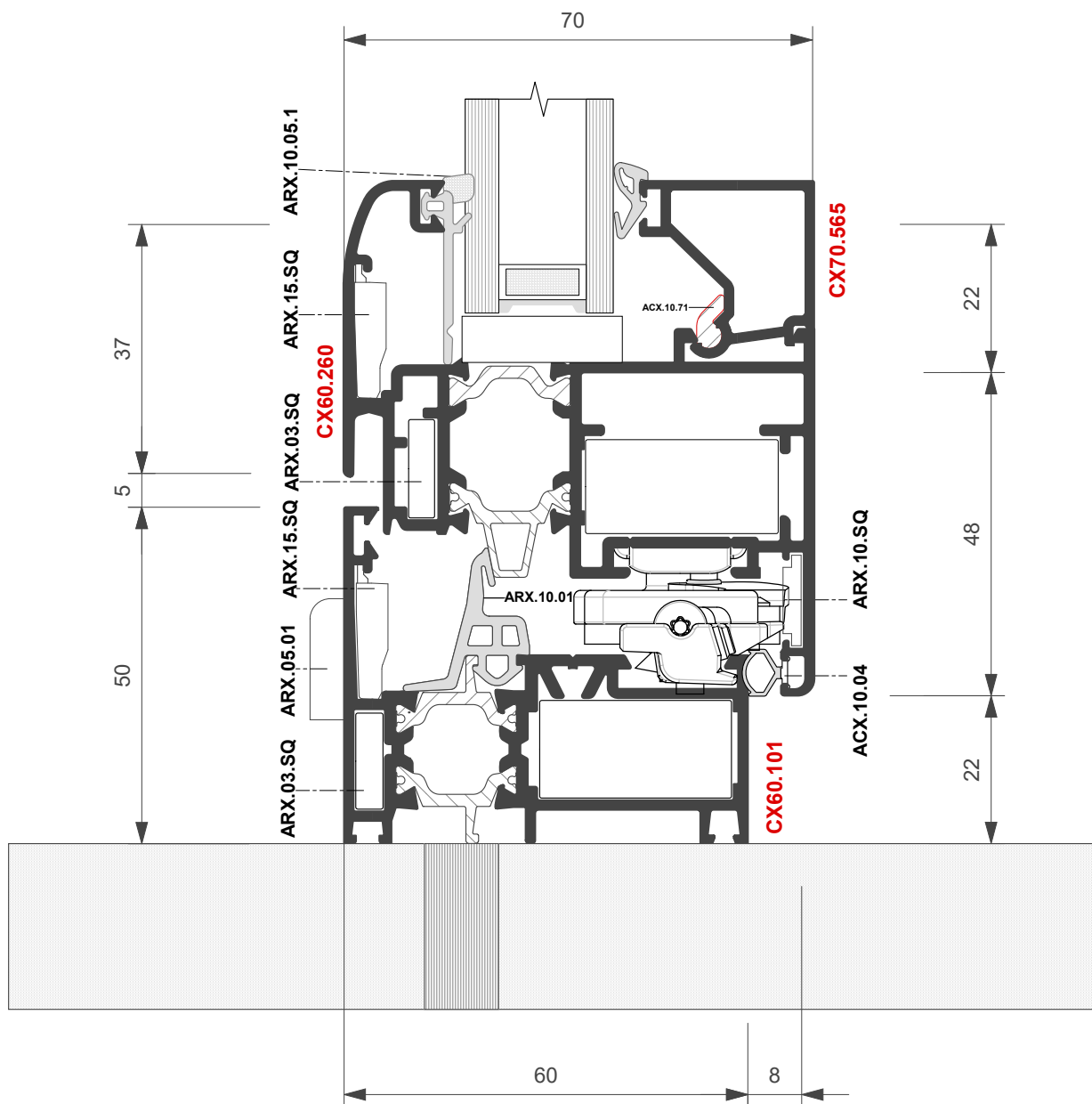
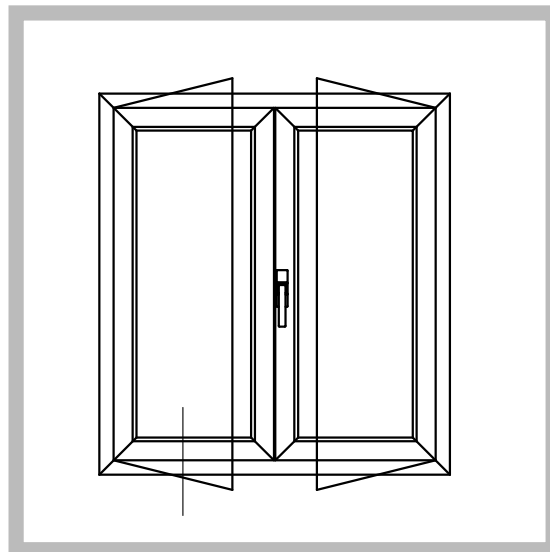



Ferramenta a nastro

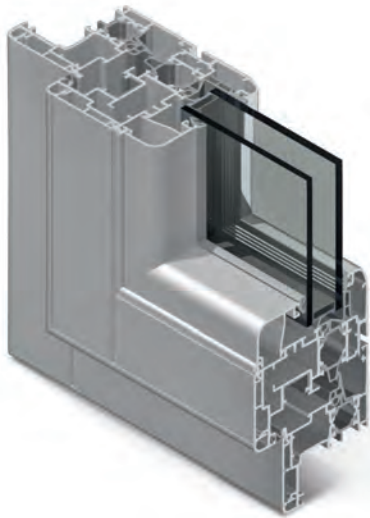

FINESTRA A DUE ANTE
ELEGANCE

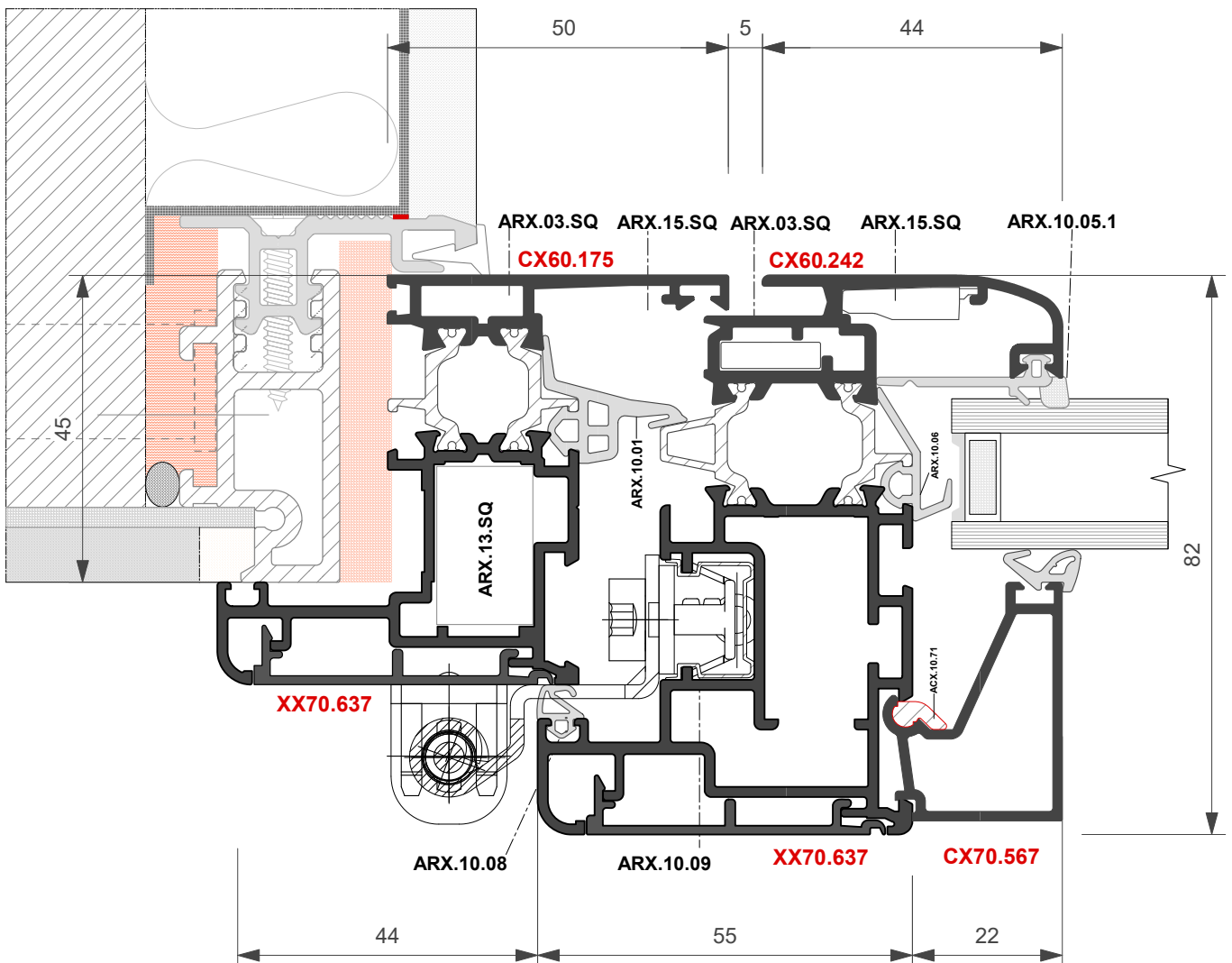
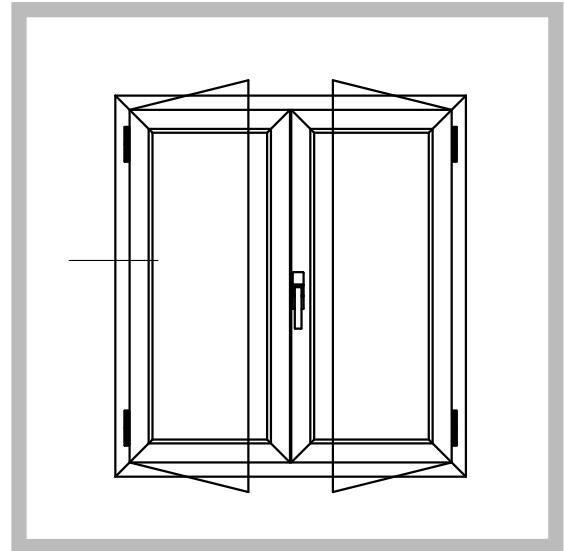



Ferramenta a nastro

FINESTRA A DUE ANTE
ELEGANCE

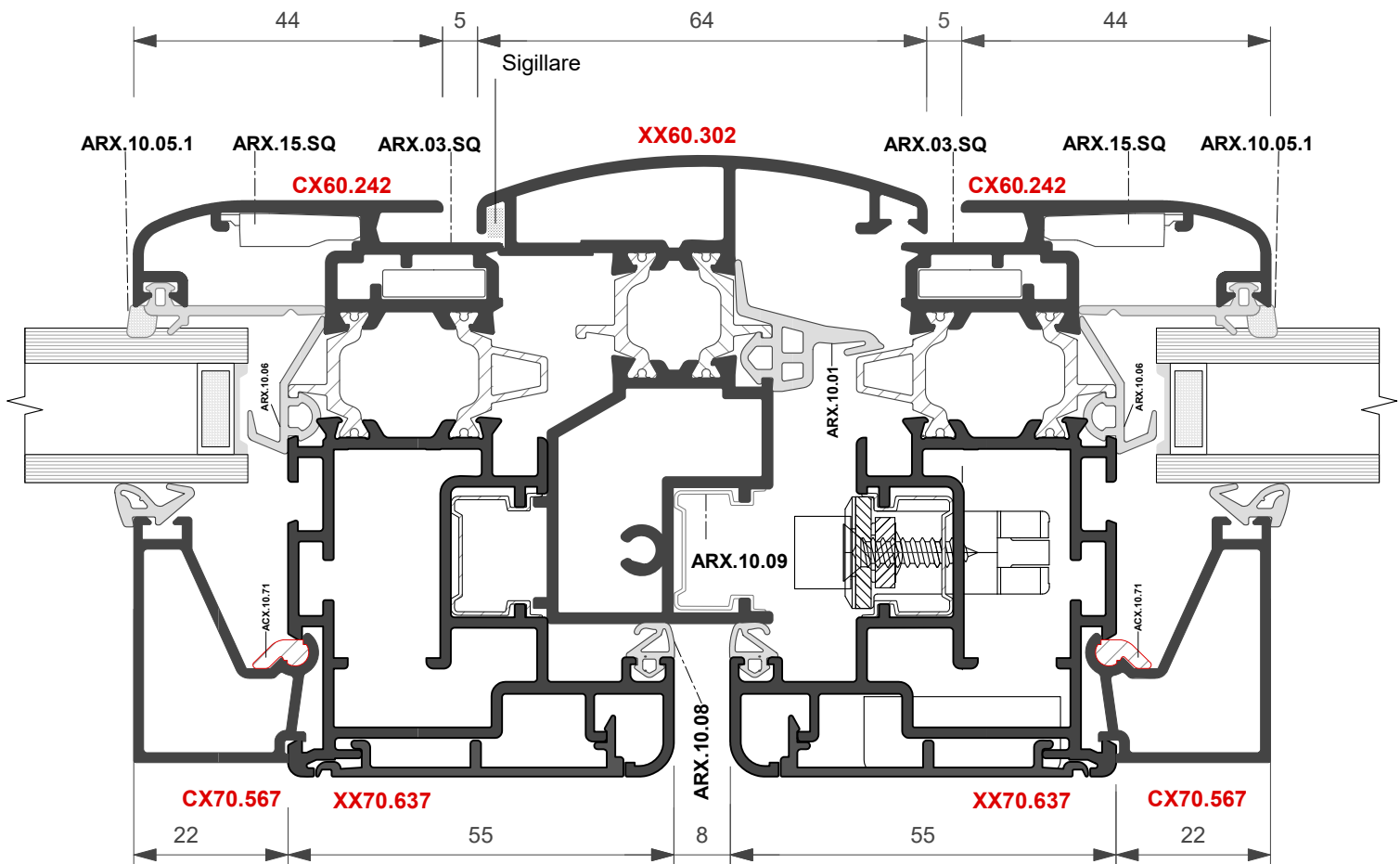
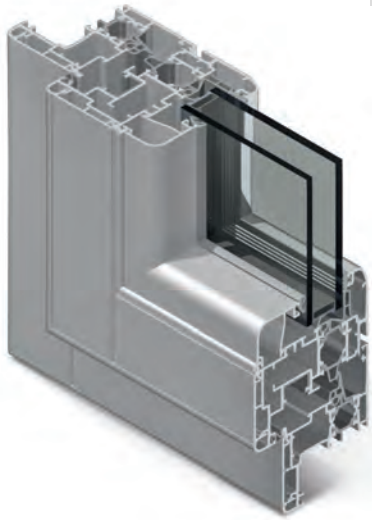
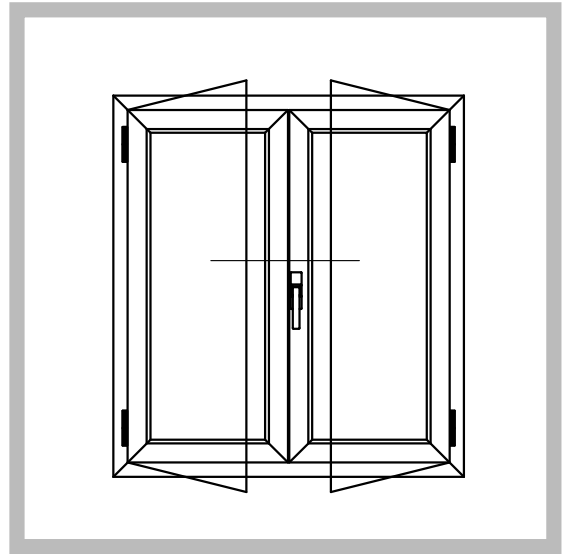



Tipologie

Gruppo **E** Principali tipologie di finestre

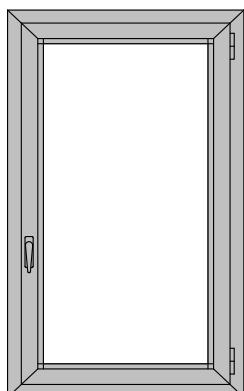

Finestra a 1 anta

Distinta di taglio vetri

| Q.tà | H | L |
|------|--------|--------|
| 1 | H -150 | L -150 |

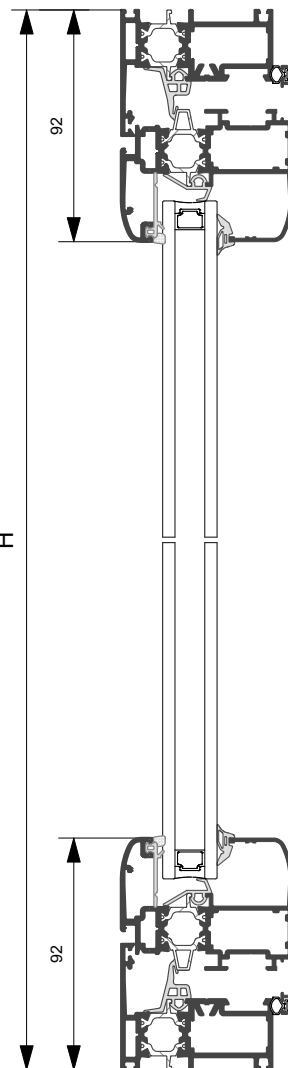
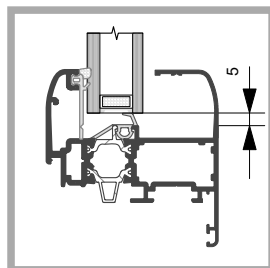

Accessori e guarnizioni

| Codice | Descrizione | Q.ta | Codice | Descrizione | Q.ta |
|------------------|-------------------------------|------|--------------------|---------------------------|-------|
| ACX.01.SQ | Squadretta a pulsante | 8 | ARX.05.01 | Copriasola scarico acqua | 2 |
| ARX.03.SQ | Squadretta cianfrinare est. | 8 | ARX.06.01 | Espansore | * |
| ARX.15.SQ | Squadretta allin. telaio/anta | 8 | ARX.10.01 | Guarnizione precamera | 2L,2H |
| ARX.10.SQ | Squadretta allin. anta int. | 4 | ACX.10.04 | Guarnizione battuta | 2L,2H |
| ACX.02.01 | Cerniera a 2 ali | 2 | ARX.10.05.1 | Guarnizione vetro esterna | 2L,2H |
| ARX.03.06 | Cremonese pressofusa | 1 | * | Guarnizione vetro interna | 2L,2H |
| ACX.03.17 | Innesti cremonese | 2 | ARX.10.02 | Angolo guarn. precamera | 4 |
| ACX.03.18 | Terminale astina | 2 | | | |
| ACX.03.13 | Ferrogliera | 2 | | | |

* secondo dimensioni

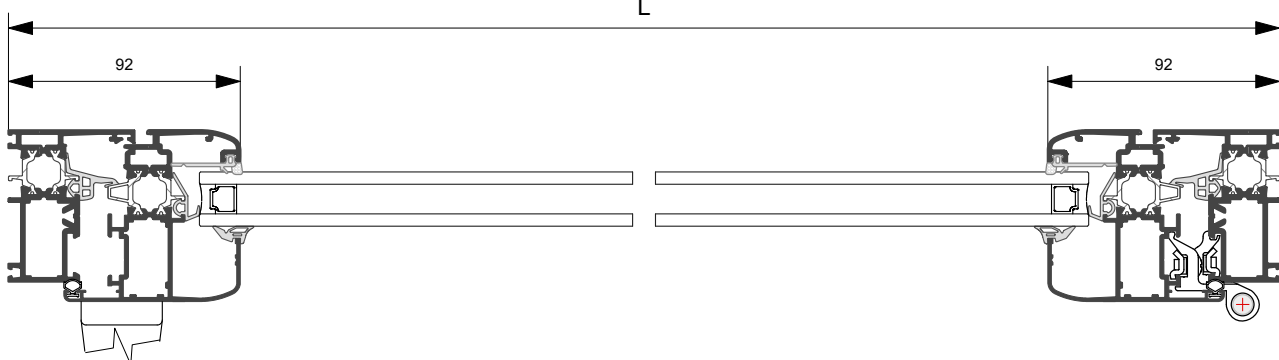

| Profilo | Taglio | Q.ta | Profilo | Taglio | Q.ta | Profilo | Taglio | Q.ta |
|--------------|--------|------|--------------|--------|------|---------|--------|------|
| CX60.101 | L | 2 | CX70.605 | | | | | |
| | H | 2 | | | | | | |
| CX60.203 | L - 44 | 2 | | | | | | |
| | H - 44 | 2 | | | | | | |

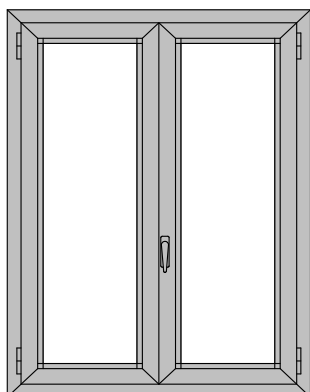

Finestra a 2 ante

Distinta di taglio vetri

| Q.tà | H | L |
|------|---------|-----------|
| 2 | H - 150 | L/2 - 132 |

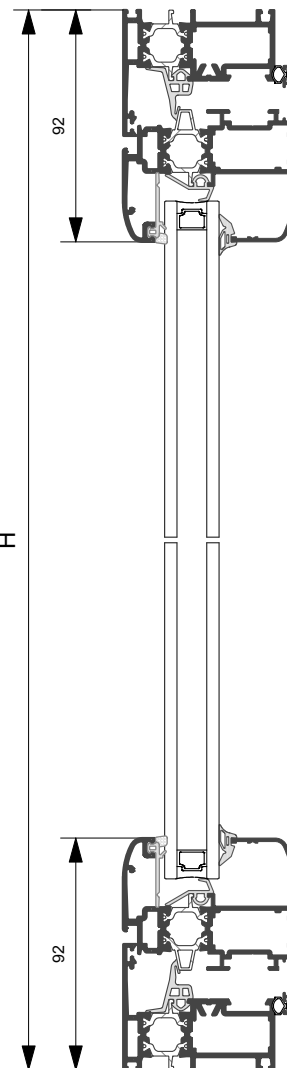
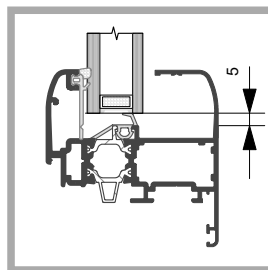

Accessori e guarnizioni

| Codice | Descrizione | Q.ta | Codice | Descrizione | Q.ta |
|-----------|-------------------------------|------|----------------------|---------------------------|-------|
| ACX.01.SQ | Squadretta a pulsante | 12 | ACX.04.01 | Tappo riporto centrale | 1 |
| ARX.03.SQ | Squadretta cianfrinare est. | 12 | ARX.05.01 | Copriasola scarico acqua | 2 |
| ARX.15.SQ | Squadretta allin. telaio/anta | 12 | ARX.06.01 | Espansore | * |
| ARX.10.SQ | Squadretta allin. anta int. | 8 | ARX.10.01 | Guarnizione precamera | 2L,3H |
| ACX.02.01 | Cerniera a 2 ali | 4 | ACX.10.04 | Guarnizione battuta | 2L,4H |
| ARX.03.06 | Cremonese pressofusa | 1 | ARX.10.05.1 | Guarnizione vetro esterna | 2L,4H |
| ACX.03.17 | Innesti cremonese | 2 | * | Guarnizione vetro interna | 2L,4H |
| ACX.03.18 | Teminale astina | 2 | ARX.10.02 | Angolo guarn. precamera | 4 |
| ACX.03.11 | Paletto a spinta | 2 | * secondo dimensioni | | |
| ACX.03.14 | Ferrogliera | 2 | | | |

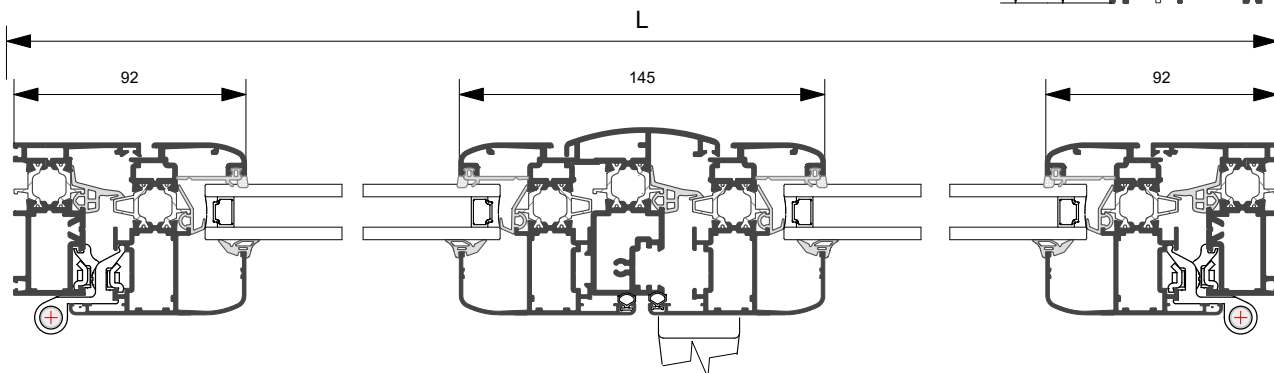

| Profilo | Taglio | Q.ta | Profilo | Taglio | Q.ta | Profilo | Taglio | Q.ta |
|--------------|------------|------|--------------|---------|------|---------|--------|------|
| CX60.101 | L | 2 | CX60.301 | H - 110 | 1 | | | |
| | H | 2 | | | | | | |
| CX60.203 | L/2 - 24.5 | 4 | CX70.605 | | | | | |
| | H - 44 | 4 | | | | | | |

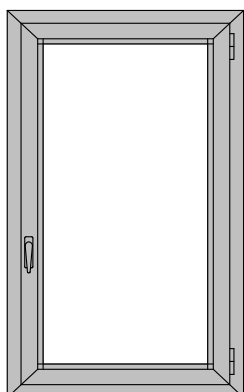

Finestra a 1 anta

Distinta di taglio vetri

| Q.ta | H | L |
|------|---------|---------|
| 1 | H - 150 | L - 150 |

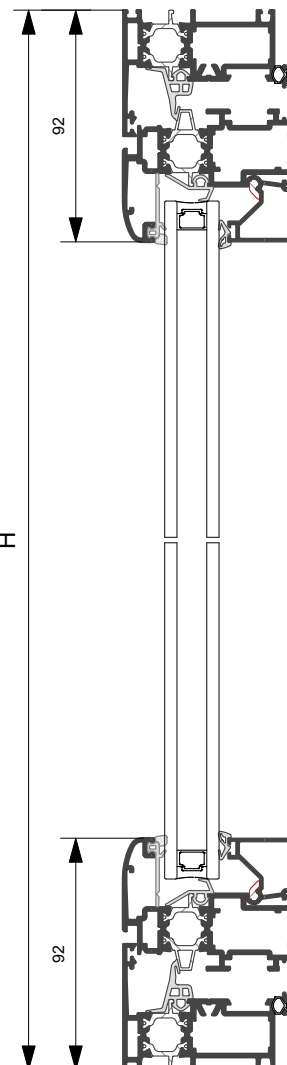
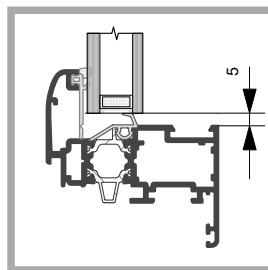

Accessori e guarnizioni

| Codice | Descrizione | Q.ta | Codice | Descrizione | Q.ta |
|------------------|-------------------------------|------|--------------------|----------------------------|-------|
| ACX.01.SQ | Squadretta a pulsante | 8 | ARX.05.01 | Copriasola scarico acqua | 2 |
| ARX.03.SQ | Squadretta cianfrinare est. | 8 | ARX.06.01 | Espansore | * |
| ARX.15.SQ | Squadretta allin. telaio/anta | 8 | ACX.07.02 | Angolo pressof. fermavetro | 4 |
| ARX.10.SQ | Squadretta allin. anta int. | 4 | ARX.10.01 | Guarnizione precamera | 2L,2H |
| ACX.02.01 | Cerniera a 2 ali | 2 | ACX.10.04 | Guarnizione battuta | 2L,2H |
| ARX.03.06 | Cremonese pressofusa | 1 | ARX.10.05.1 | Guarnizione vetro esterna | 2L,2H |
| ACX.03.17 | Innesti cremonese | 2 | * | Guarnizione vetro interna | 2L,2H |
| ACX.03.18 | Teminale astina | 2 | ARX.10.02 | Angolo guarn. precamera | 4 |
| ACX.03.13 | Ferrogliera | 2 | | | |

* secondo dimensioni

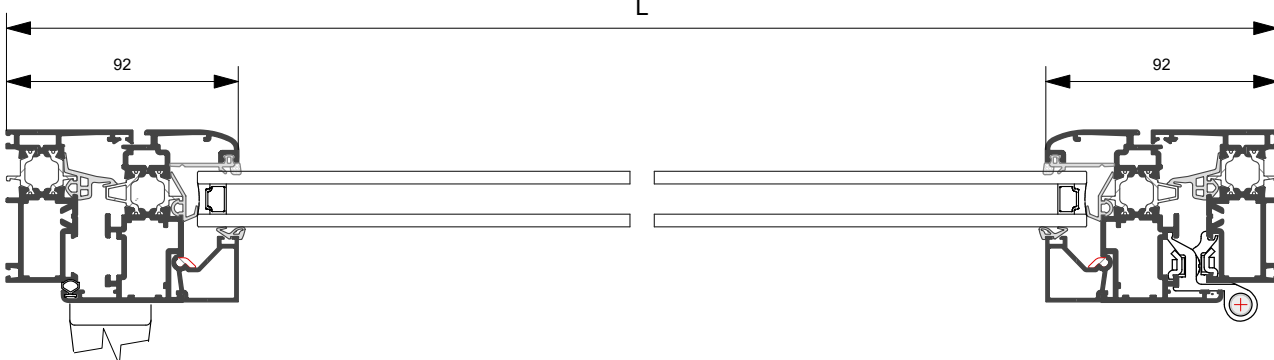

| Profilo | Taglio | Q.ta | Profilo | Taglio | Q.ta | Profilo | Taglio | Q.ta |
|--------------|---------------|------|--------------|----------------|------|---------|--------|------|
| CX60.101 | L | 2 | CX70.565 | L - 184 | 2 | | | |
| | H | 2 | | H - 184 | 2 | | | |
| CX60.201 | L - 44 | 2 | CX70.605 | | | | | |
| | H - 44 | 2 | | | | | | |

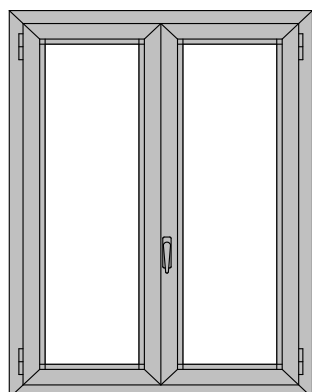

Finestra a 2 ante

Distinta di taglio vetri

| Q.ta | H | L |
|------|--------|----------|
| 2 | H -150 | L/2 -132 |

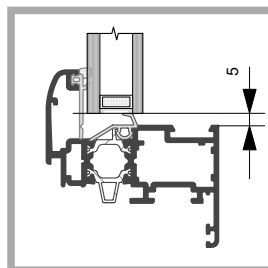

| Codice | Descrizione | Q.ta | Codice | Descrizione | Q.ta |
|-----------|-------------------------------|------|----------------------|----------------------------|-------|
| ACX.01.SQ | Squadretta a pulsante | 12 | ACX.04.01 | Tappo riporto centrale | 1 |
| ARX.03.SQ | Squadretta cianfrinare est. | 12 | ARX.05.01 | Copriasola scarico acqua | 2 |
| ARX.15.SQ | Squadretta allin. telaio/anta | 12 | ARX.06.01 | Espansore | * |
| ARX.10.SQ | Squadretta allin. anta int. | 8 | ACX.07.02 | Angolo pressof. fermavetro | 8 |
| ACX.02.01 | Cerniera a 2 ali | 4 | ARX.10.01 | Guarnizione precamera | 2L,3H |
| ARX.03.06 | Cremonese pressofusa | 1 | ACX.10.04 | Guarnizione battuta | 2L,4H |
| ACX.03.17 | Innesti cremonese | 2 | ARX.10.05.1 | Guarnizione vetro esterna | 2L,4H |
| ACX.03.18 | Teminale astina | 2 | * | Guarnizione vetro interna | 2L,4H |
| ACX.03.11 | Paletto a spinta | 2 | ARX.10.02 | Angolo guarn. precamera | 4 |
| ACX.03.14 | Ferrogliera | 2 | * secondo dimensioni | | |

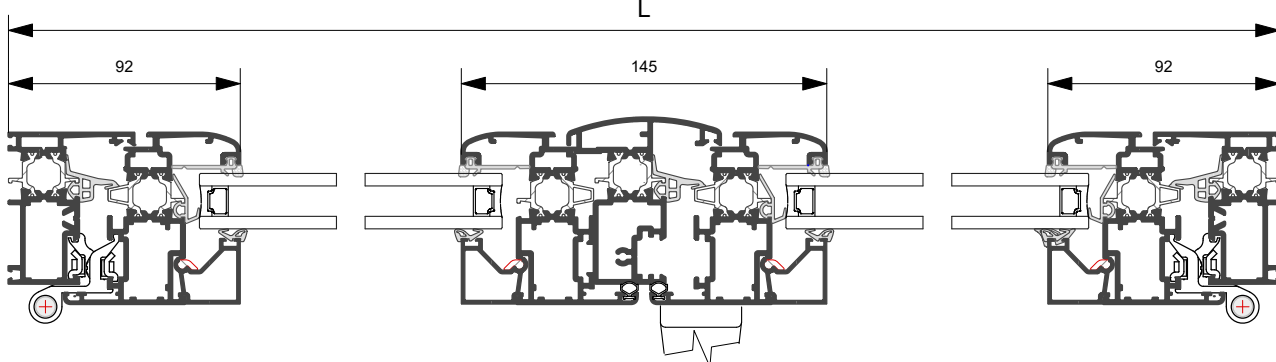

| Profilo | Taglio | Q.ta | Profilo | Taglio | Q.ta | Profilo | Taglio | Q.ta |
|----------|------------|------|----------|-------------|------|----------|-----------|------|
| CX60.101 | L | 2 | CX70.565 | L/2 - 164.5 | 4 | CX70.605 | [Diagram] | |
| | H | 2 | | H - 184 | 4 | | | |
| CX60.201 | L/2 - 24.5 | 4 | CX60.301 | H - 110 | 1 | | | |
| | H - 44 | 4 | | | | | | |

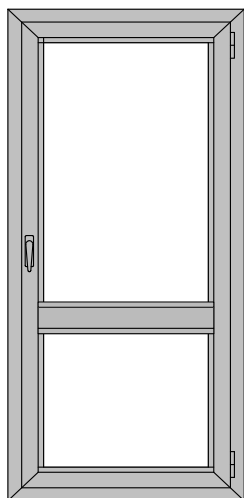

Porta a 1 anta

Distinta di taglio vetri

| Q.tà | H | L |
|------|---------|--------|
| 1 | H-HF-58 | L -150 |
| 1 | HF -154 | L -150 |

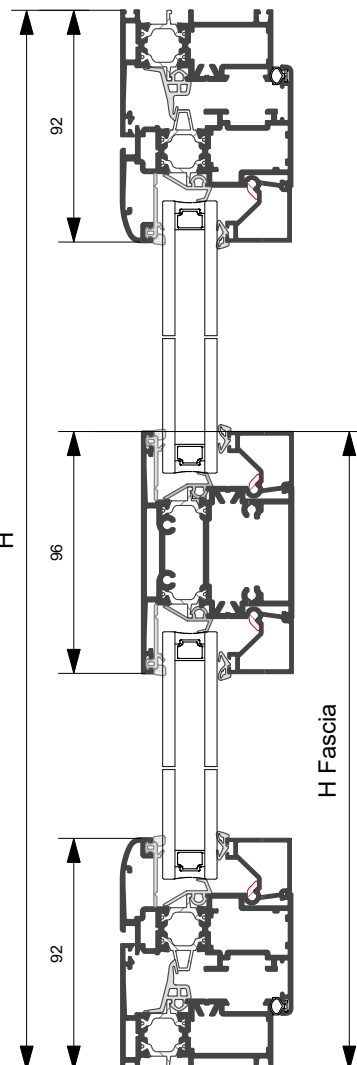
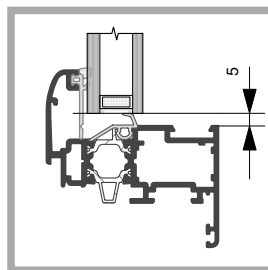

Accessori e guarnizioni

| Codice | Descrizione | Q.ta | Codice | Descrizione | Q.ta |
|-----------|-------------------------------|------|-------------|----------------------------|-------|
| ACX.01.SQ | Squadretta a pulsante | 8 | ARX.05.01 | Copriasola scarico acqua | 2 |
| ARX.03.SQ | Squadretta cianfrinare est. | 8 | ARX.06.01 | Espansore | * |
| ARX.15.SQ | Squadretta allin. telaio/anta | 8 | ACX.07.02 | Angolo pressof. fermavetro | 8 |
| ARX.10.SQ | Squadretta allin. anta int. | 4 | ARX.10.01 | Guarnizione precamera | 2L,2H |
| ACX.02.01 | Cerniera a 2 ali | 3 | ACX.10.04 | Guarnizione battuta | 2L,2H |
| ARX.03.06 | Cremonese pressofusa | 1 | ARX.10.05.1 | Guarnizione vetro esterna | 4L,2H |
| ACX.03.17 | Innesti cremonese | 2 | * | Guarnizione vetro interna | 4L,2H |
| ACX.03.18 | Teminale astina | 2 | ARX.10.02 | Angolo guarn. precamera | 4 |
| ACX.03.13 | Ferrogliera | 2 | | | |

* secondo dimensioni

L

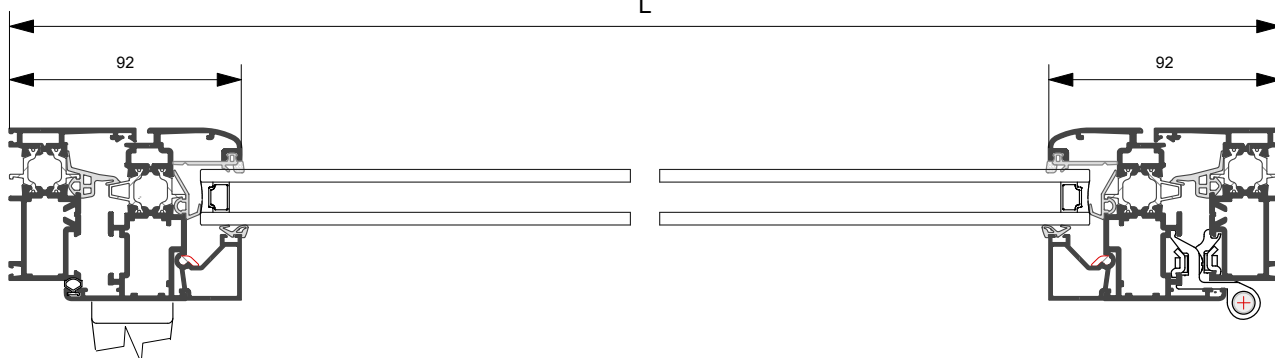

| Profilo | Taglio | Q.ta | Profilo | Taglio | Q.ta | Profilo | Taglio | Q.ta |
|----------|--------|------|----------|------------|------|----------|---------|------|
| CX60.101 | L | 2 | CX70.565 | L - 184 | 4 | CX60.402 | L - 130 | 1 |
| | H | 2 | | H - HF -92 | 2 | | | |
| CX60.201 | L - 44 | 2 | | HF - 188 | 2 | | | |
| | H - 44 | 2 | CX70.605 | | | | | |

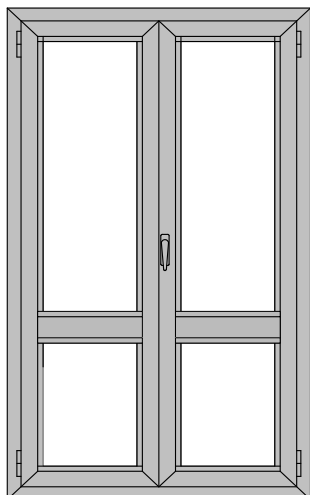

Porta a 2 ante

Distinta di taglio vetri

| Q.ta | H | L |
|------|---------|----------|
| 1 | H-HF-58 | L/2 -130 |
| 1 | HF -154 | L/2 -130 |

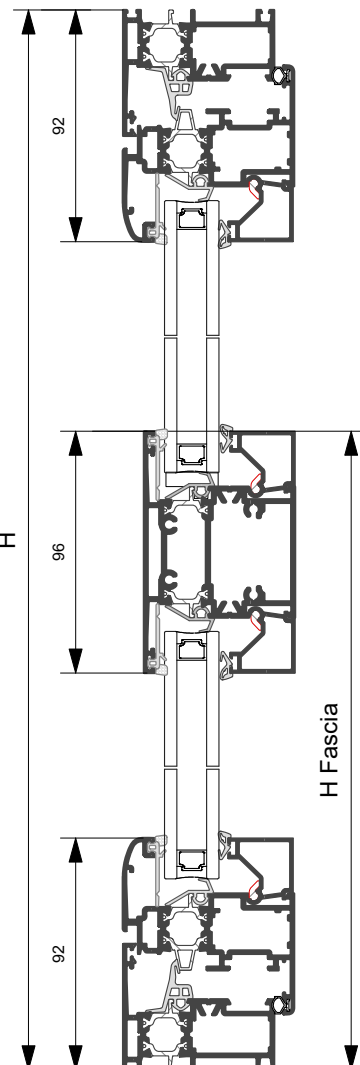
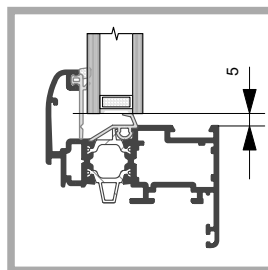

Accessori e guarnizioni

| Codice | Descrizione | Q.ta | Codice | Descrizione | Q.ta |
|-----------|-------------------------------|------|----------------------|----------------------------|-------|
| ACX.01.SQ | Squadretta a pulsante | 12 | ACX.04.01 | Tappo riporto centrale | 1 |
| ARX.03.SQ | Squadretta cianfrinare est. | 12 | ARX.05.01 | Copriasola scarico acqua | 2 |
| ARX.15.SQ | Squadretta allin. telaio/anta | 12 | ARX.06.01 | Espansore | * |
| ARX.10.SQ | Squadretta allin. anta int. | 8 | ACX.07.02 | Angolo pressof. fermavetro | 16 |
| ACX.02.01 | Cerniera a 2 ali | 6 | ARX.10.01 | Guarnizione precamera | 2L,3H |
| ARX.03.06 | Cremonese pressofusa | 1 | ACX.10.04 | Guarnizione battuta | 2L,4H |
| ACX.03.17 | Innesti cremonese | 2 | ARX.10.05.1 | Guarnizione vetro esterna | 4L,4H |
| ACX.03.18 | Teminale astina | 2 | * | Guarnizione vetro interna | 4L,4H |
| ACX.03.11 | Paletto a spinta | 2 | ARX.10.02 | Angolo guarn. precamera | 4 |
| ACX.03.14 | Ferrogliera | 2 | * secondo dimensioni | | |

L

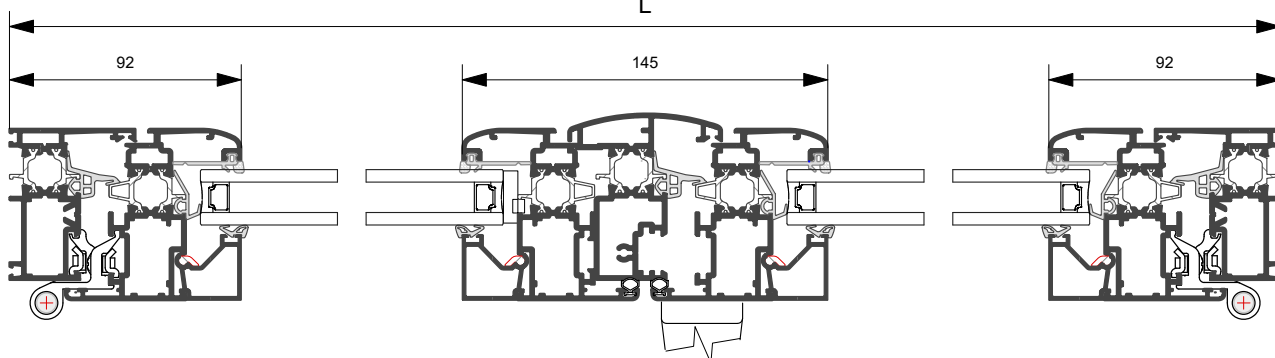

| Profilo | Taglio | Q.ta | Profilo | Taglio | Q.ta | Profilo | Taglio | Q.ta |
|----------|------------|------|----------|-------------|------|----------|-------------|------|
| CX60.101 | L | 2 | CX70.565 | L/2 - 164.5 | 8 | CX60.301 | H - 110 | 1 |
| | H | 2 | | H - HF - 92 | 4 | | | |
| CX60.201 | L/2 - 24.5 | 4 | | HF - 188 | 4 | CX60.402 | L/2 - 110.5 | 2 |
| | H - 44 | 2 | CX70.605 | | 1 | | | |



Collegamento muratura

Gruppo **F**

Sezione particolareggiata
attacco alla muratura





FISSAGGIO ALLA MURATURA

| | |
|-----------------------------------------------|-----------------------------------------------------------------------------------|
| ARX.06.01 |  |
| Descrizione Registro Universale | |

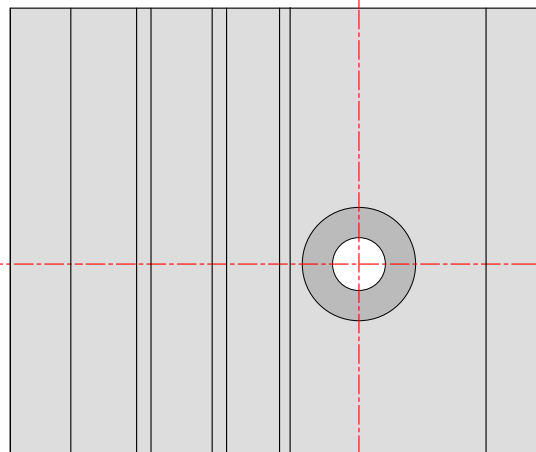
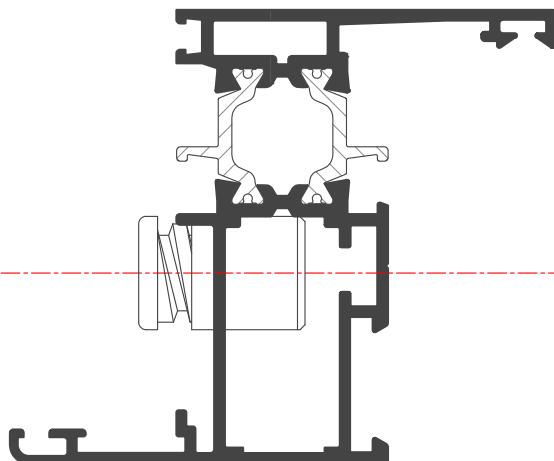
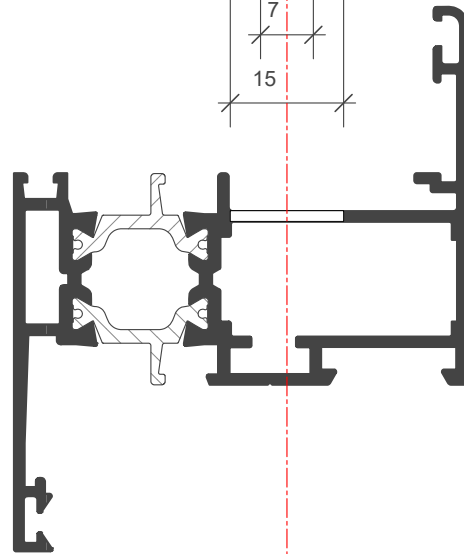
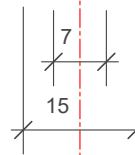
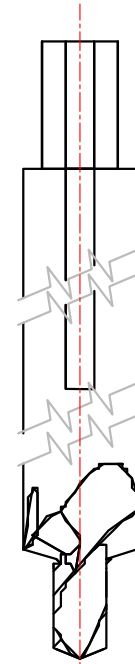



FISSAGGIO ALLA MURATURA

Schiuma flessibile
permeabile al vapore
tipo **FLEXIFOAM**

Autospandente
chiusura acqua
tipo **BG1**

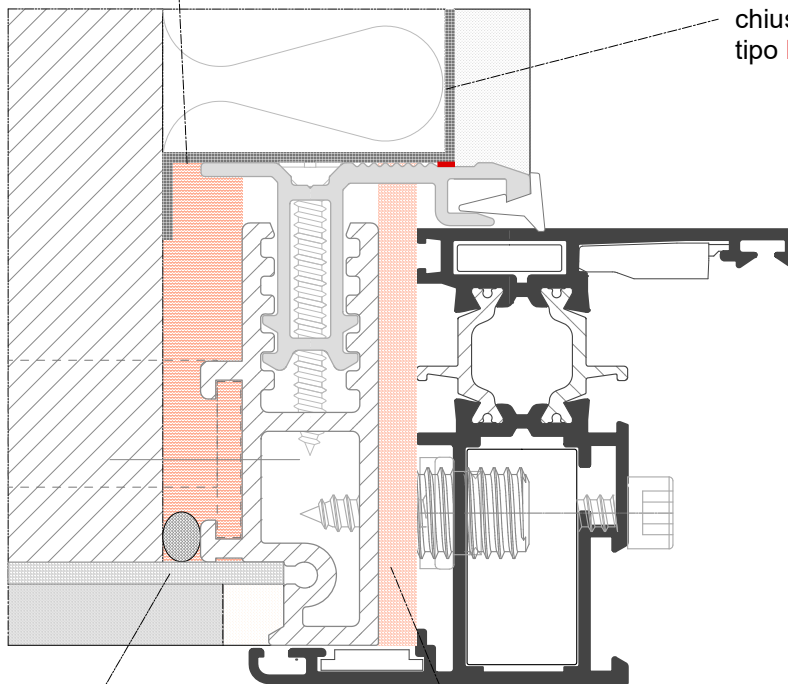

Freno vapore
tipo **FOLIENBAND**

Nastro autoespandente
tipo **ACTIVEplus**

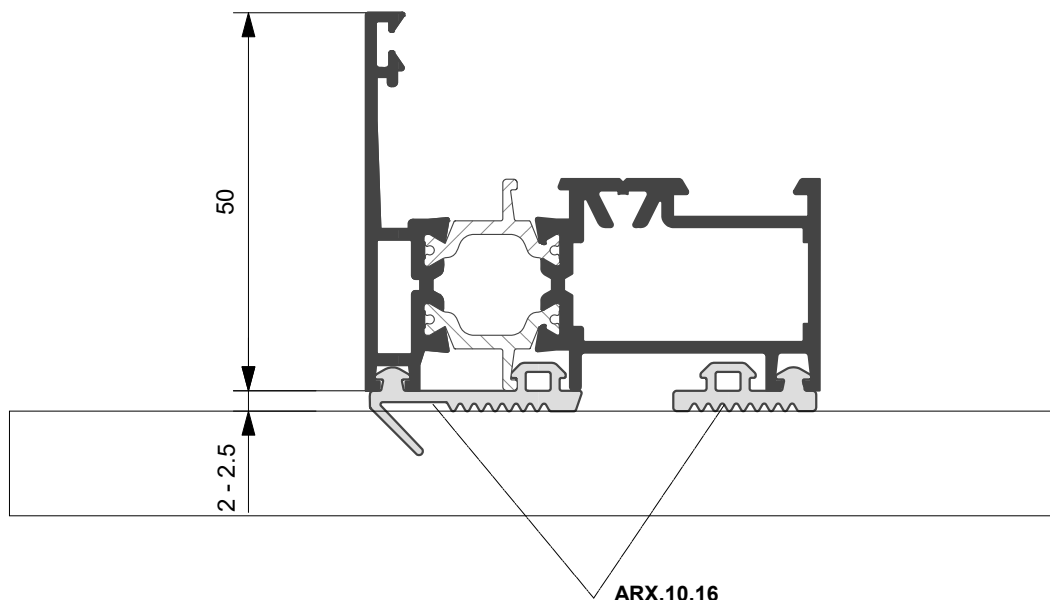

ARX.10.16



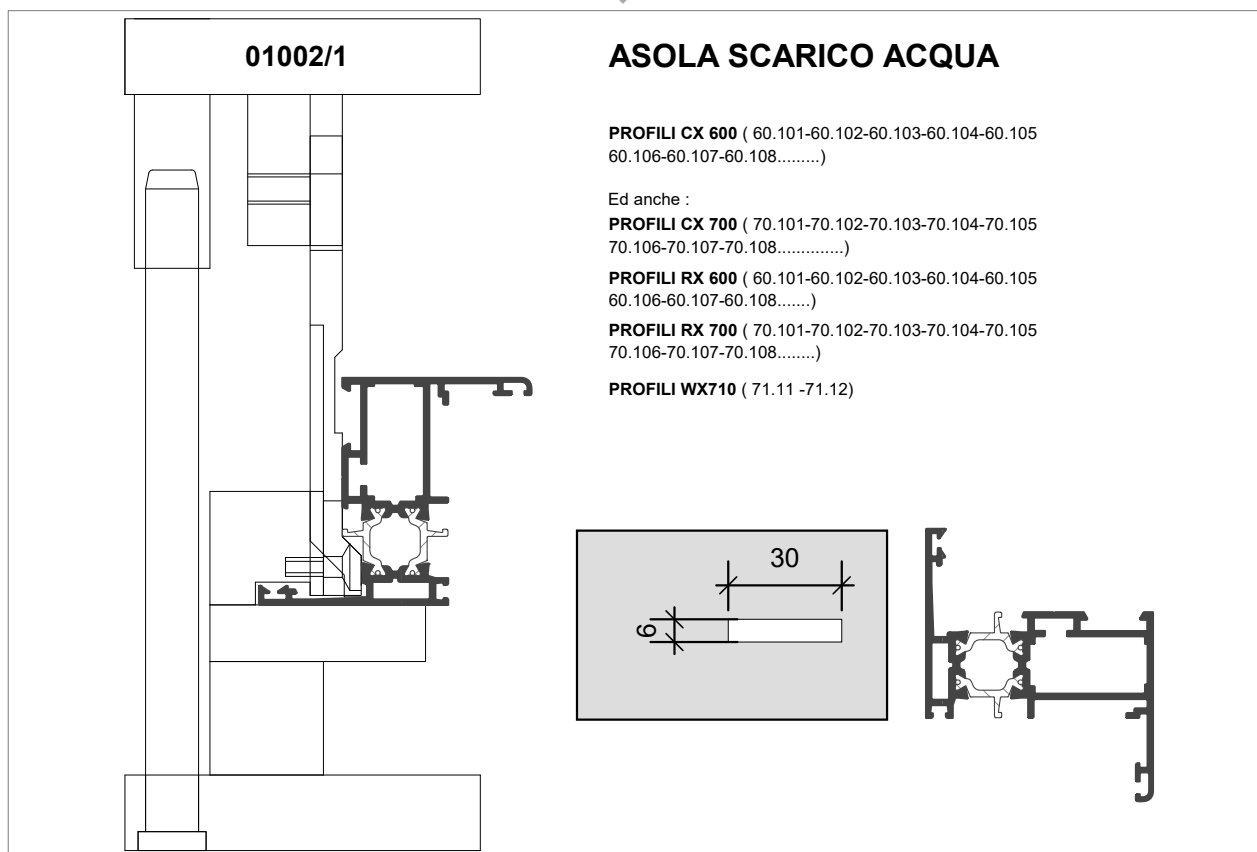

ASOLA SCARICO ACQUA

PROFILI CX 600 (60.101-60.102-60.103-60.104-60.105
60.106-60.107-60.108.....)

Ed anche :

PROFILI CX 700 (70.101-70.102-70.103-70.104-70.105
70.106-70.107-70.108.....)

PROFILI RX 600 (60.101-60.102-60.103-60.104-60.105
60.106-60.107-60.108.....)

PROFILI RX 700 (70.101-70.102-70.103-70.104-70.105
70.106-70.107-70.108.....)

PROFILI WX710 (71.11 -71.12)

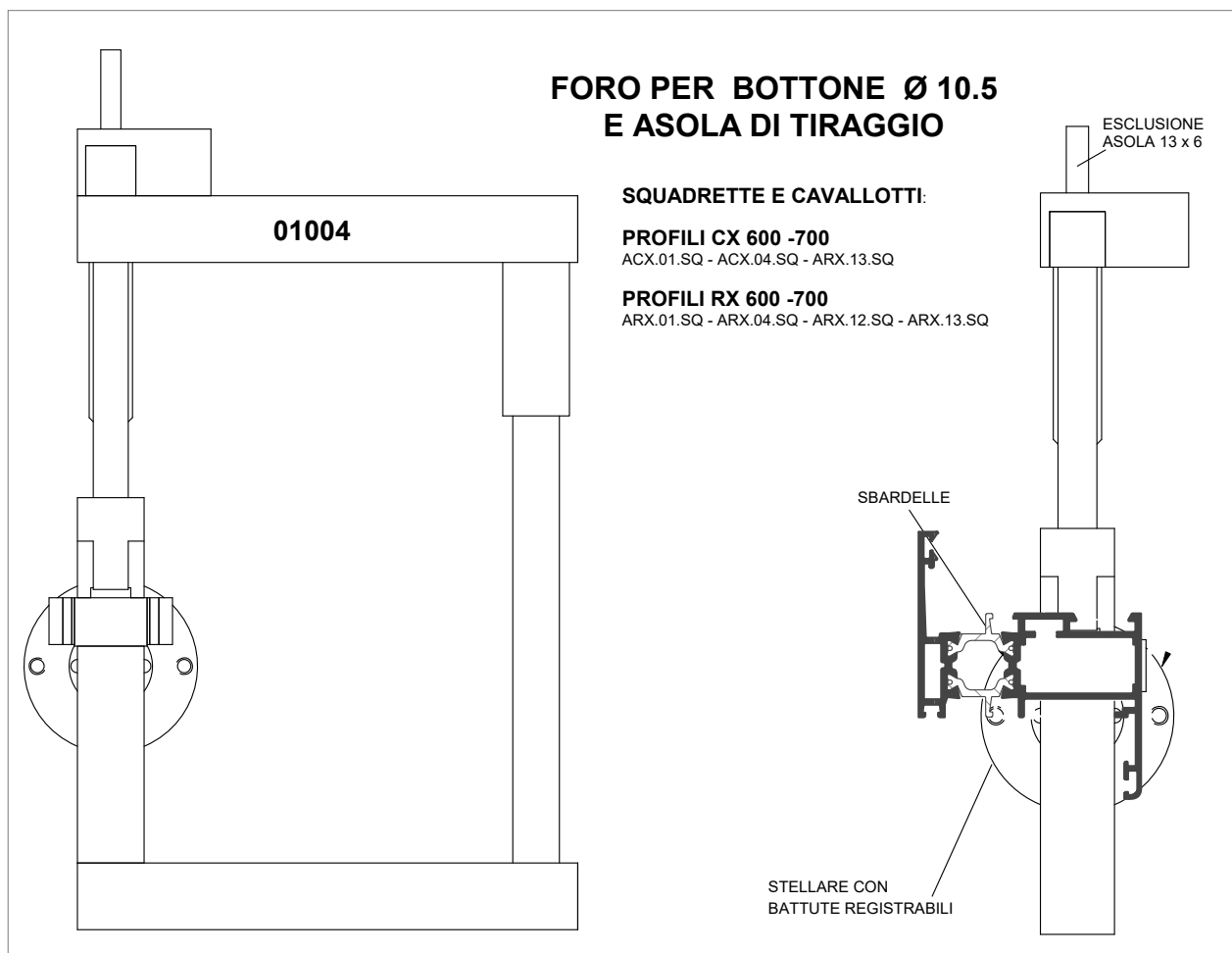
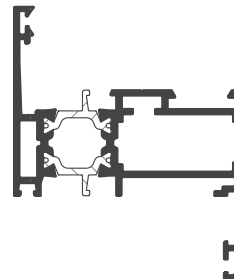
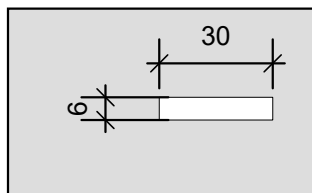

**FORO PER BOTTONE Ø 10.5
E ASOLA DI TIRAGGIO**

SQUADRETTE E CAVALLOTTI:

PROFILI CX 600 -700
ACX.01.SQ - ACX.04.SQ - ARX.13.SQ

PROFILI RX 600 -700
ARX.01.SQ - ARX.04.SQ - ARX.12.SQ - ARX.13.SQ

SBARDELLE

ESCLUSIONE
ASOLA 13 x 6

STELLARE CON
BATTUTE REGISTRABILI

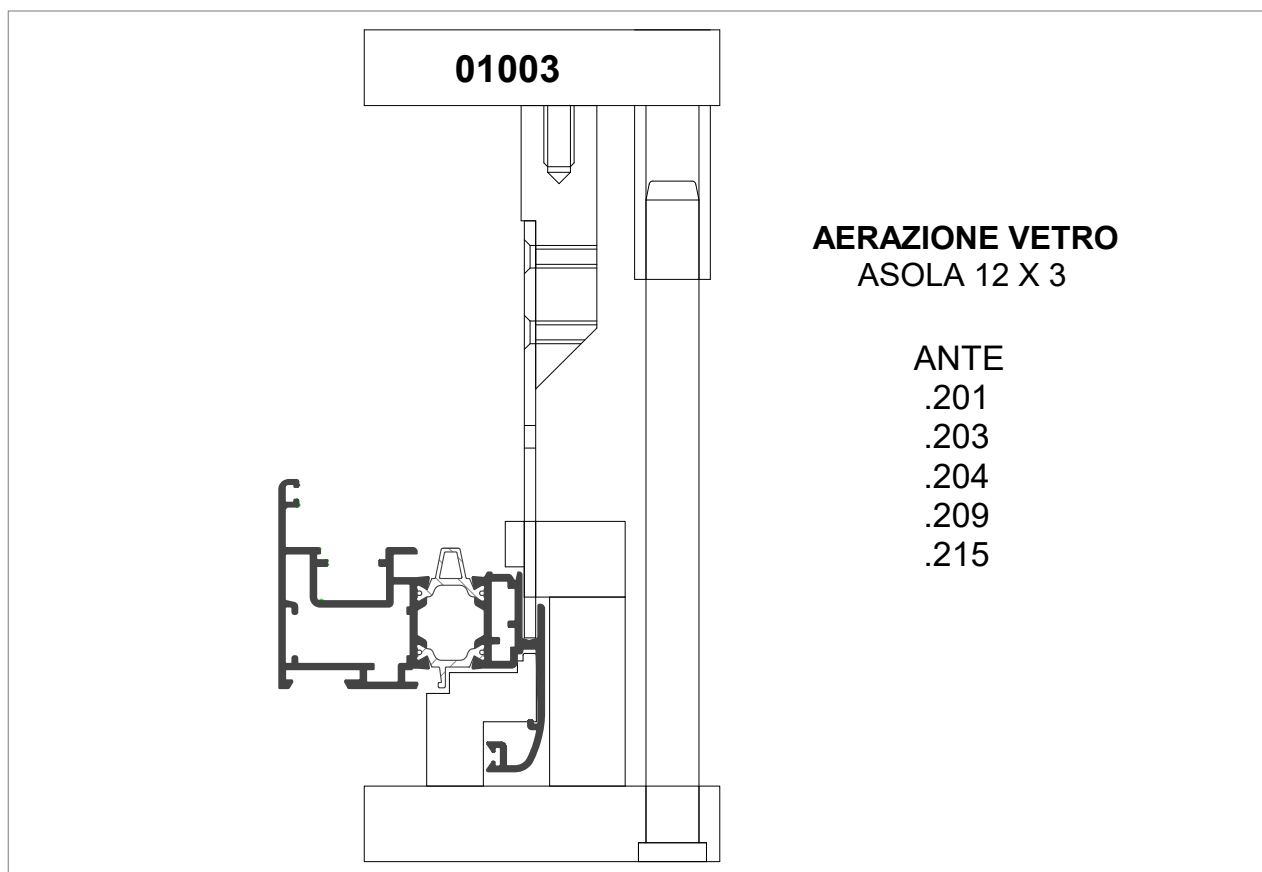
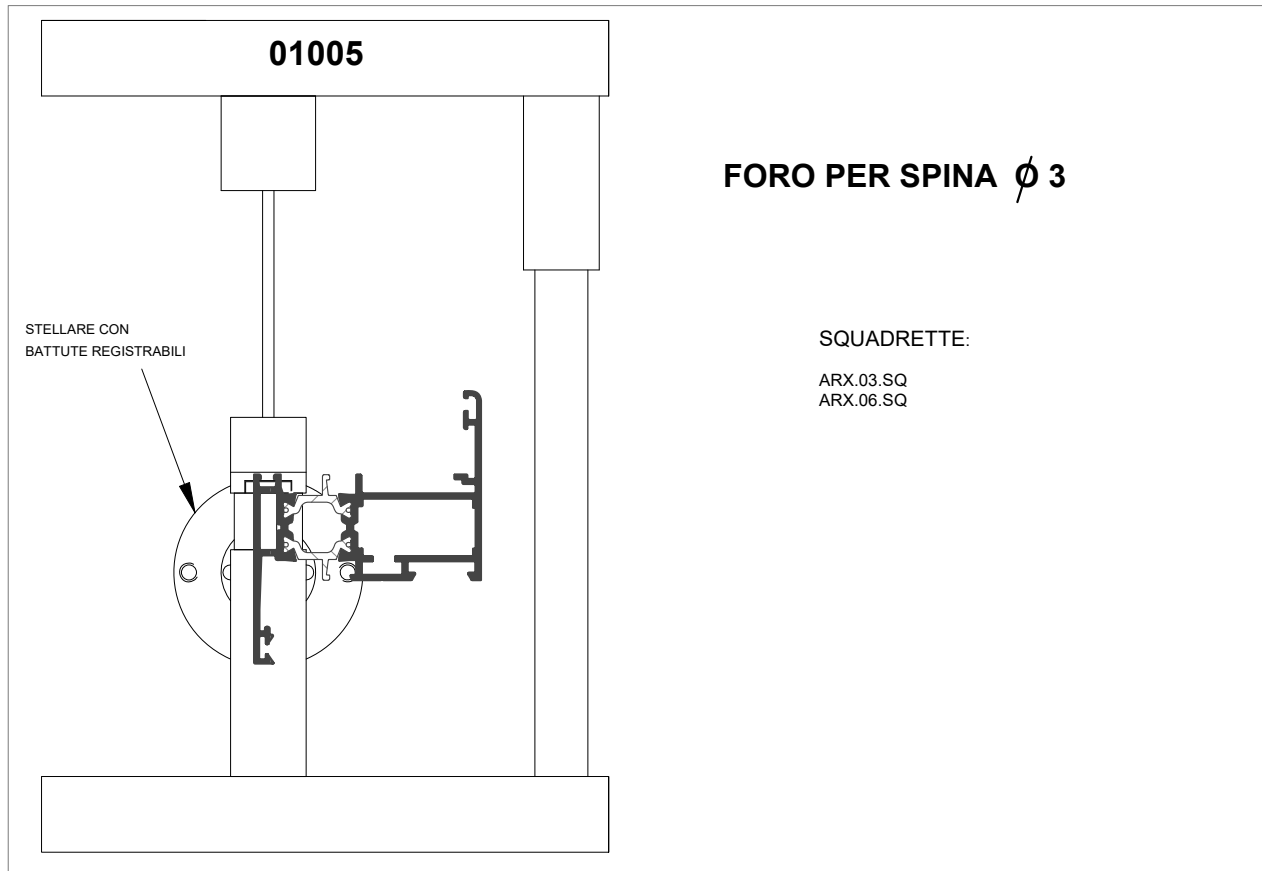

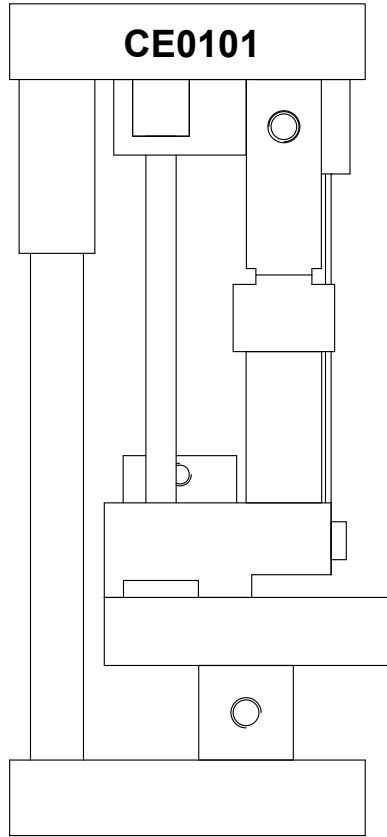

LAVORAZIONI

- LAVORAZIONE CREMONESE DA 104mm
- FORO Ø8 DI TESTA E PASSANTE, DOPPIO FORO DA Ø8 SU ASTINA
- ASPORTAZIONE DENTINI PASSAGGIO ASTA

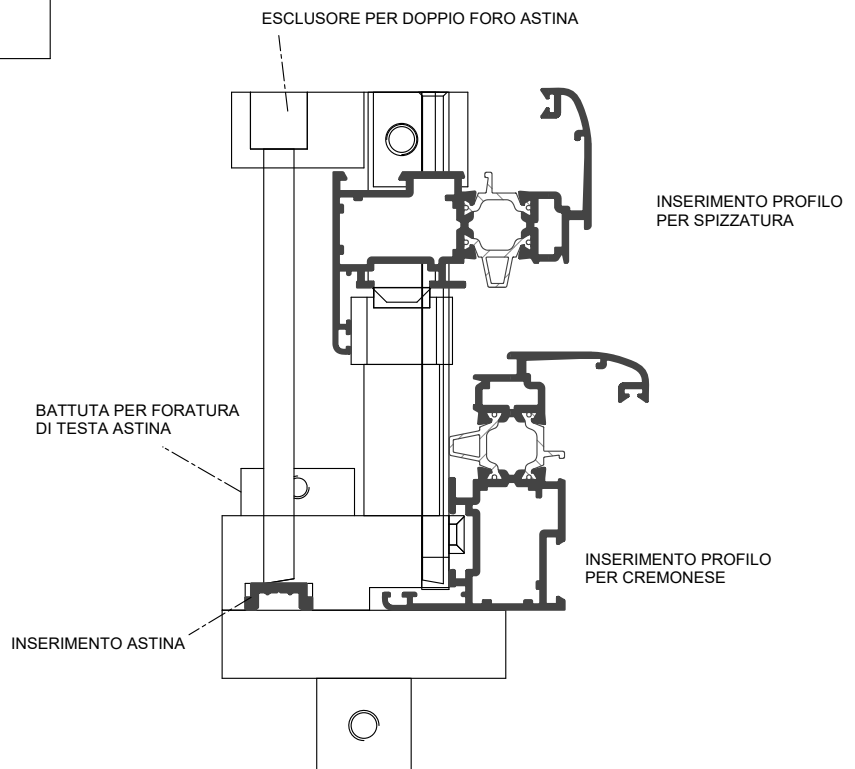

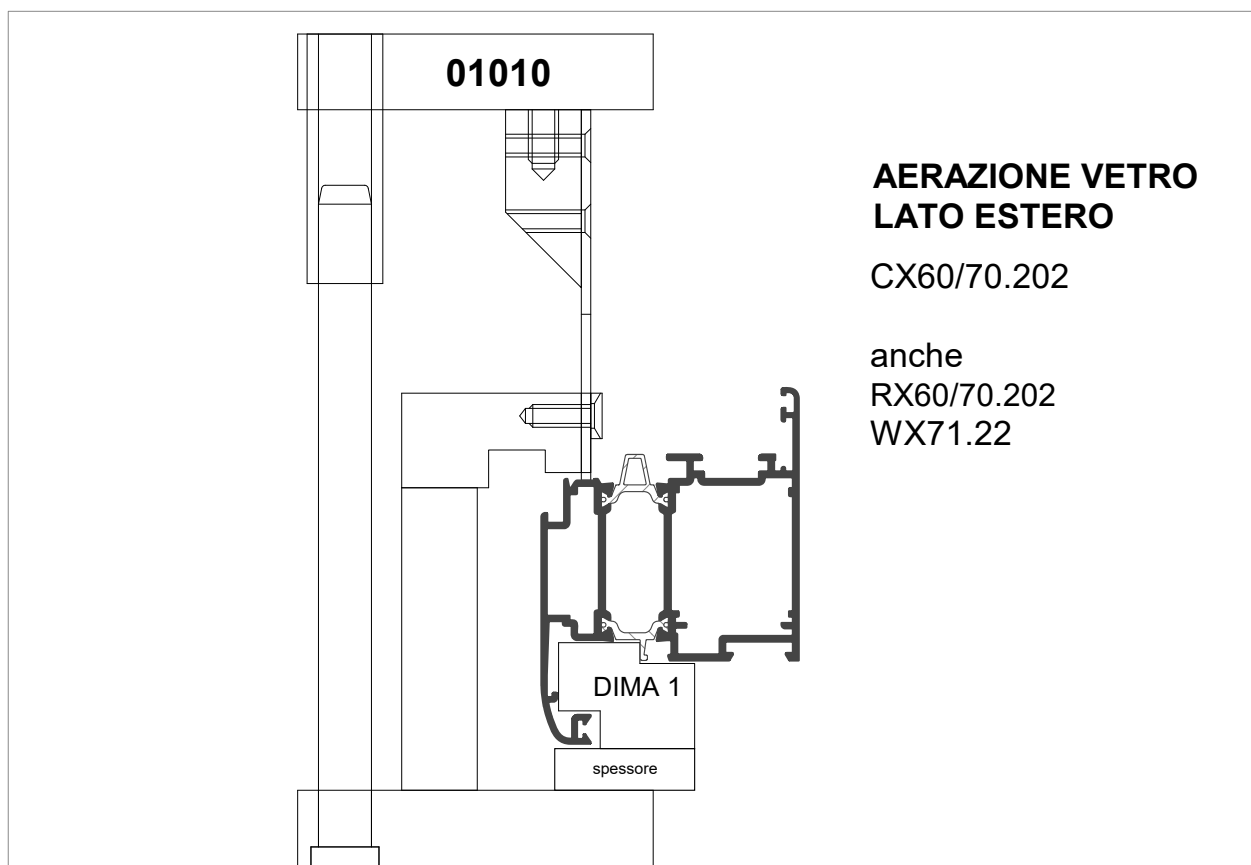
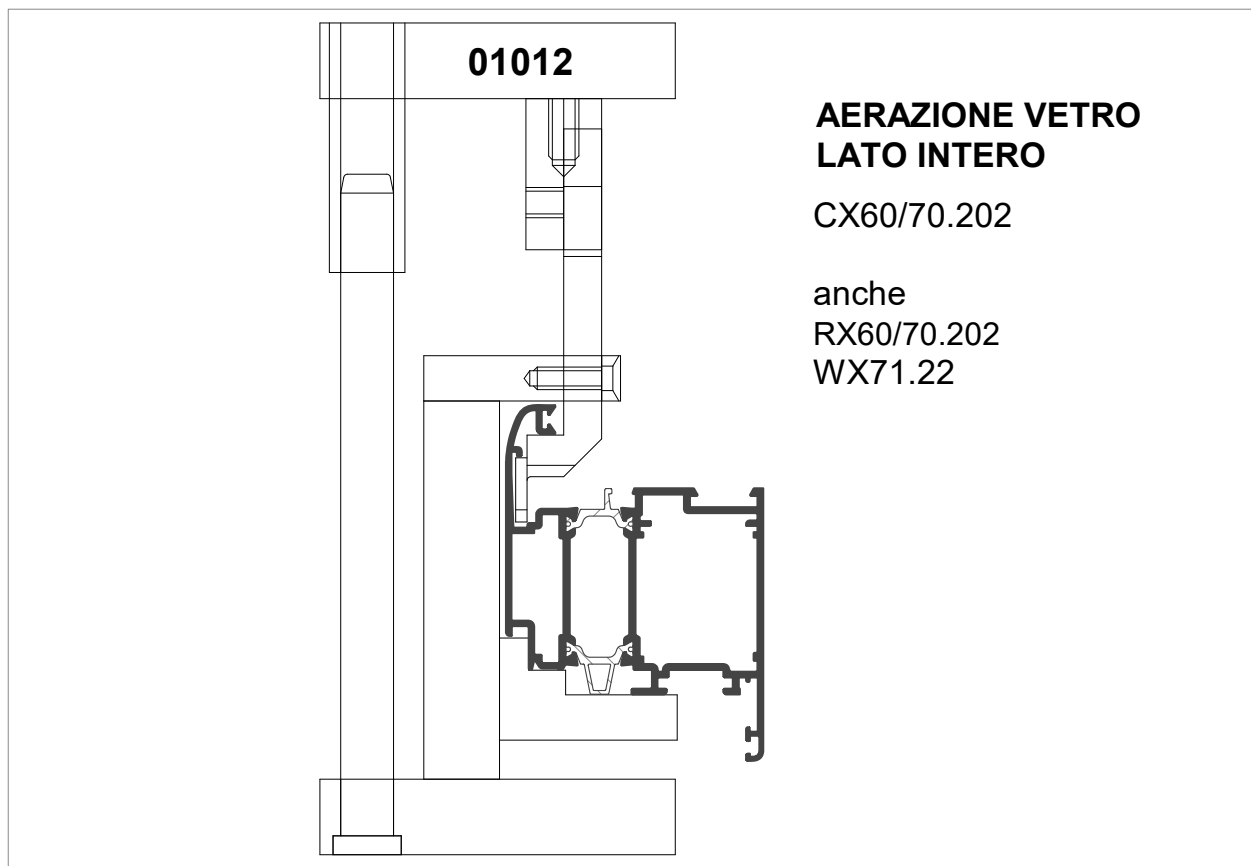

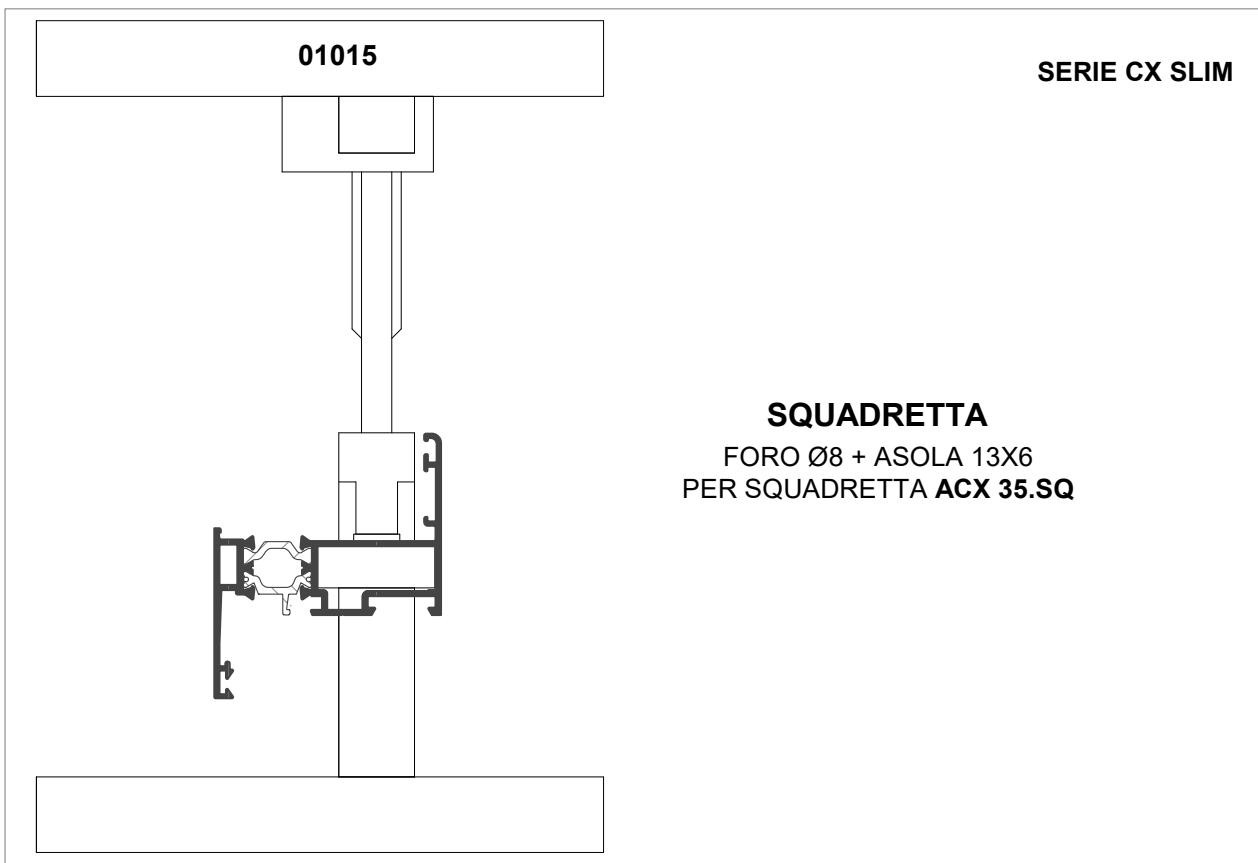
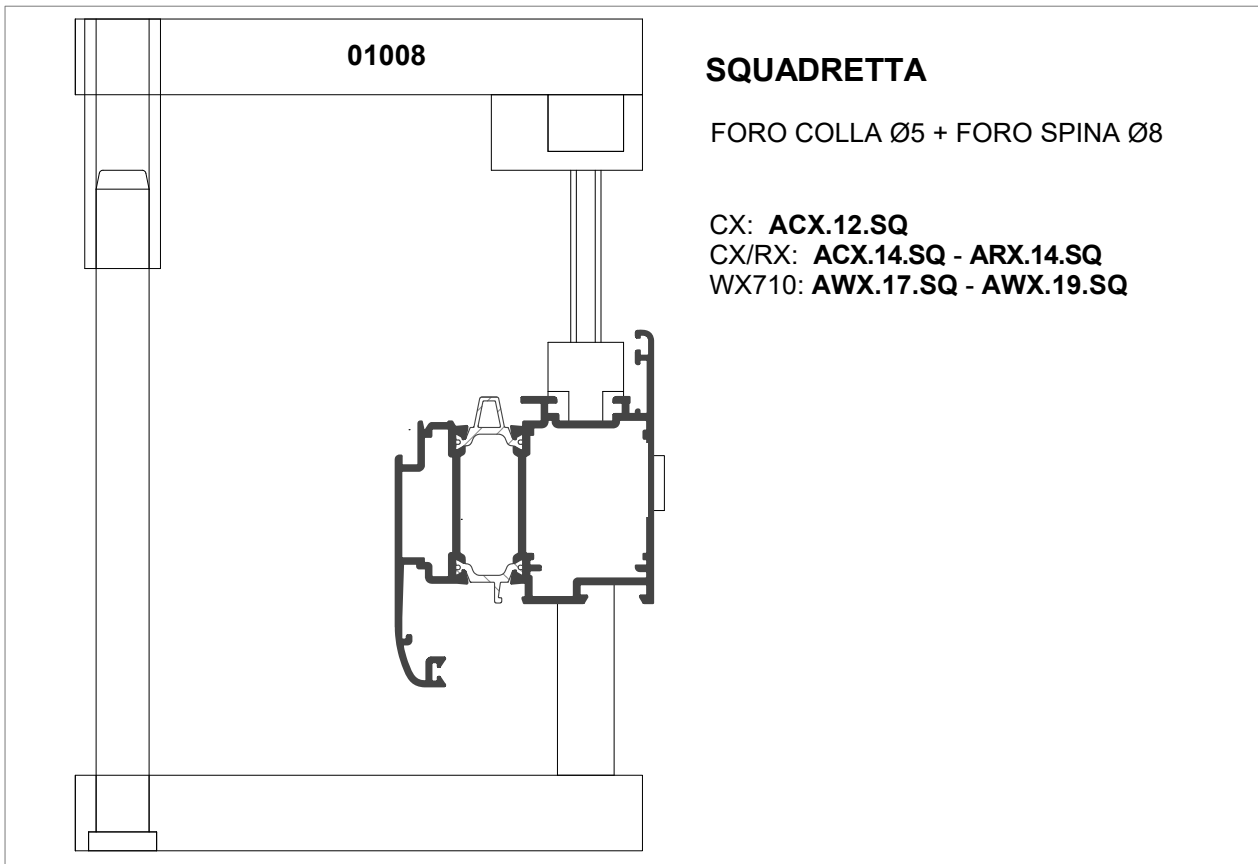

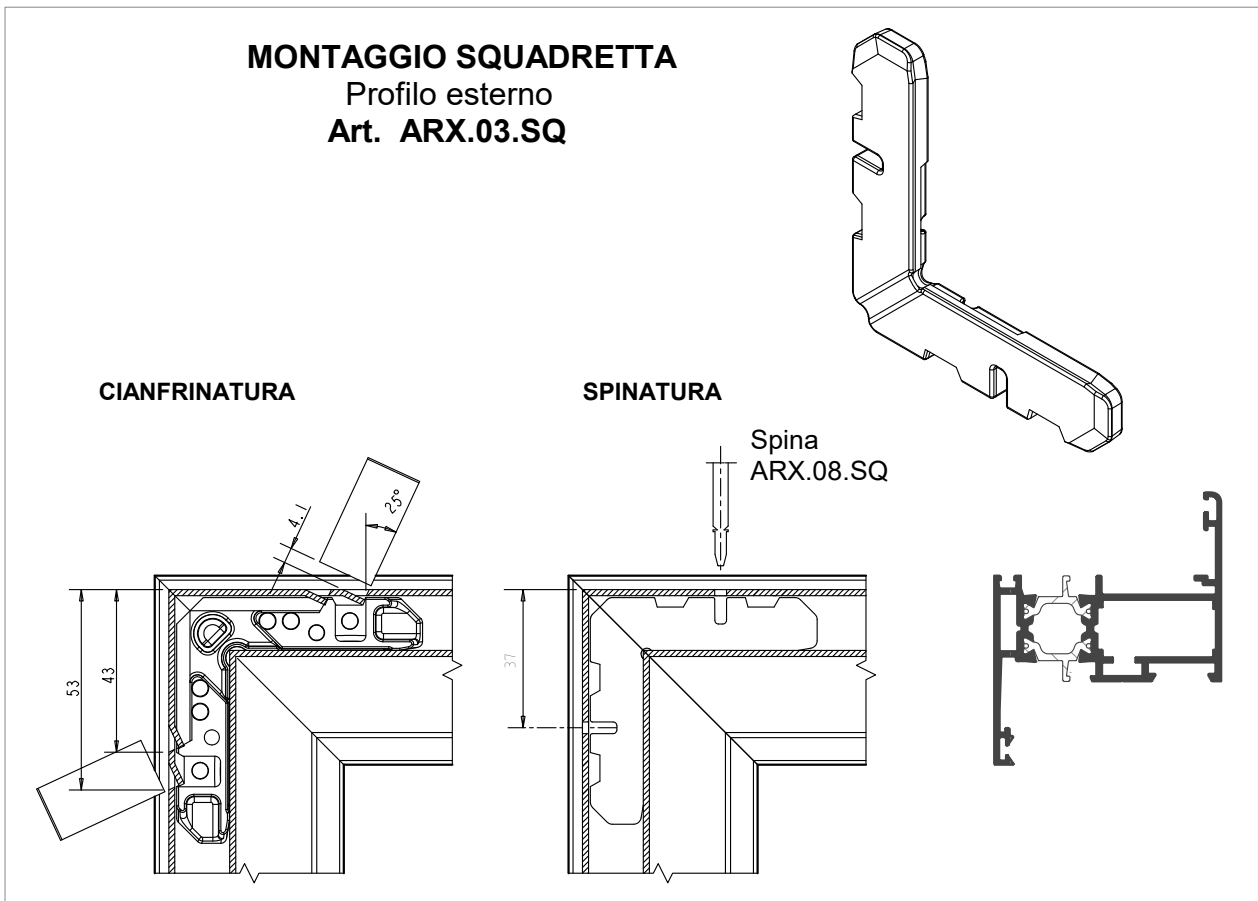
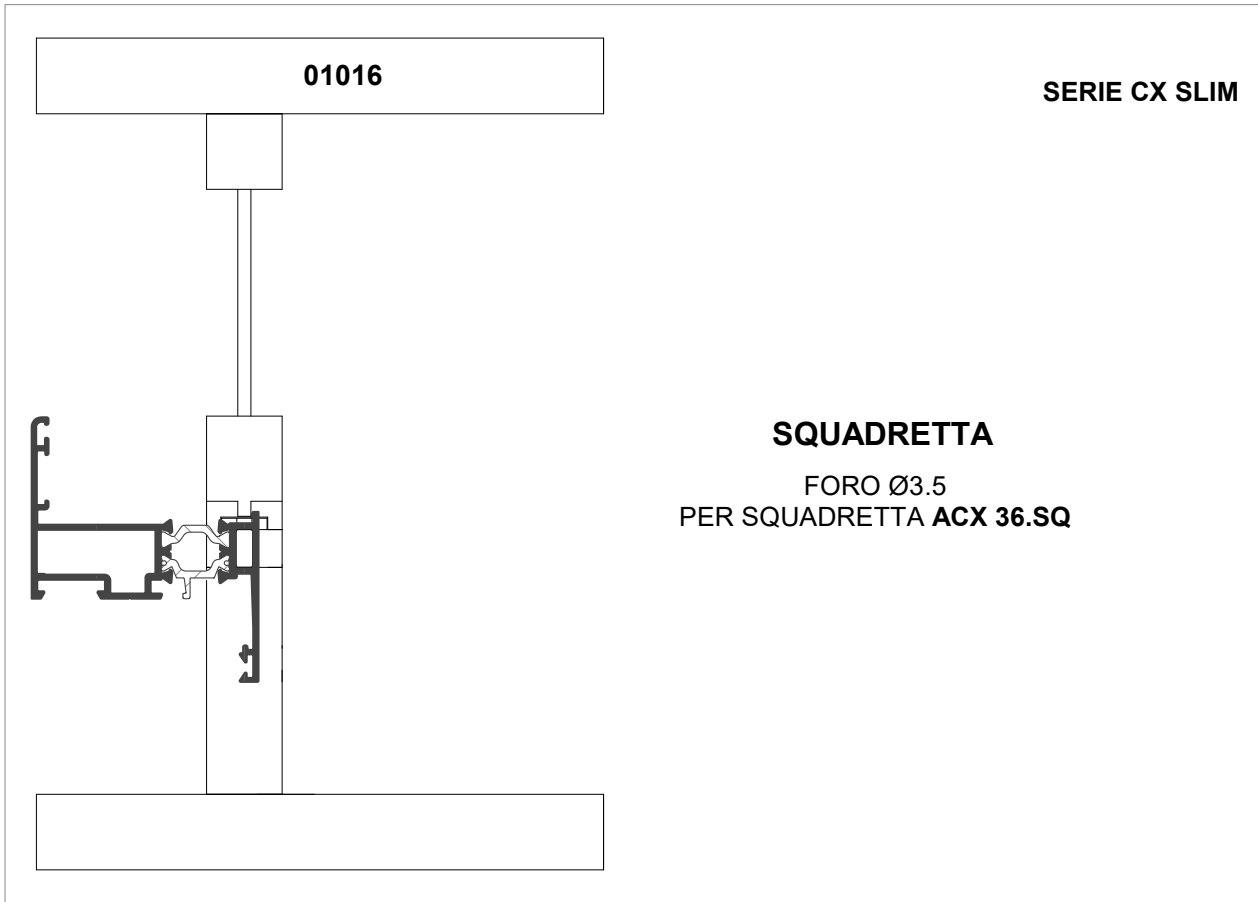



MONTAGGIO SQUADRETTA
Profilo esterno
Art. ARX.06.SQ

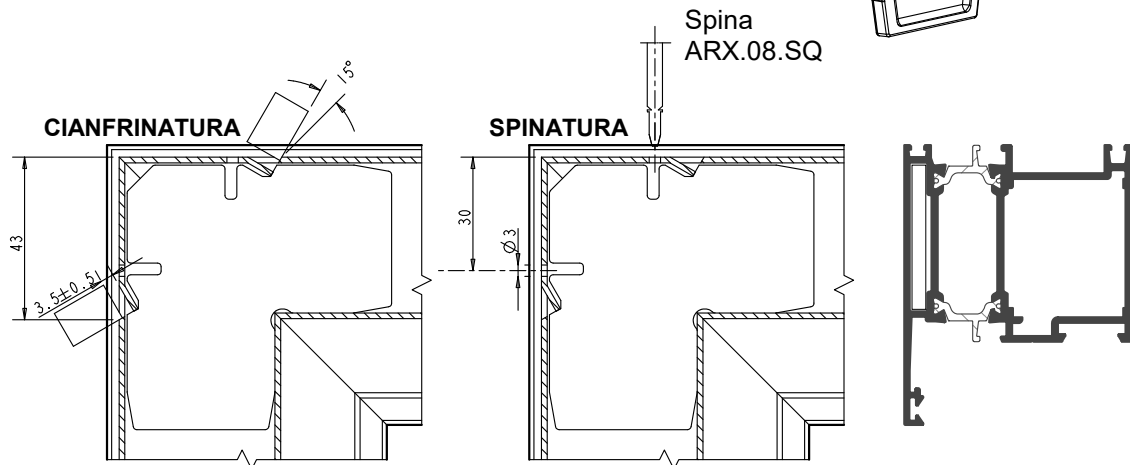
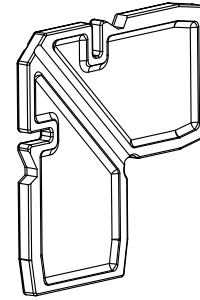

MONTAGGIO SQUADRETTA A PULSANTE
Profilo interno
Art. ACX.01.SQ

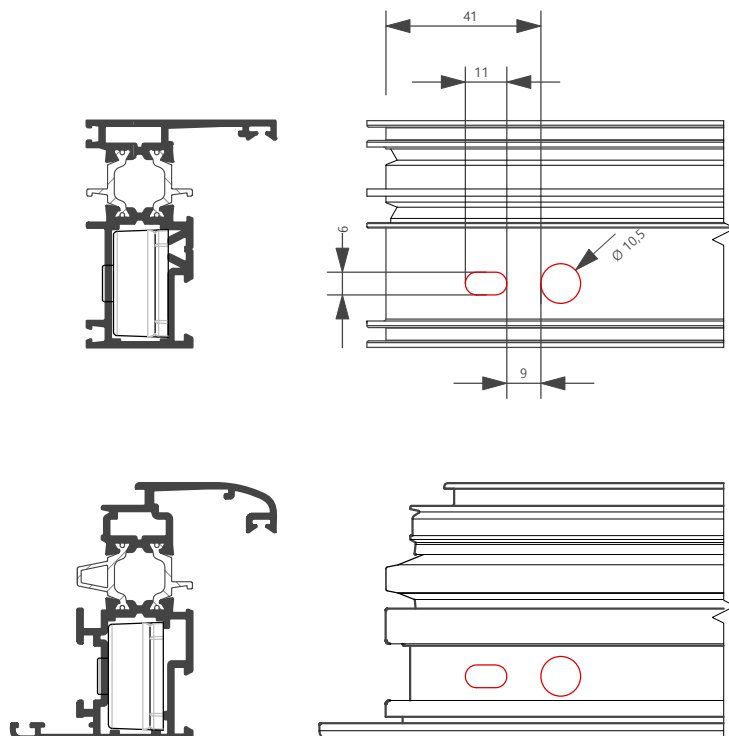
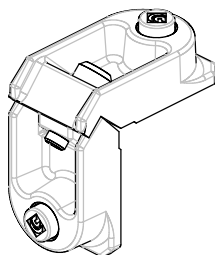



MONTAGGIO SQUADRETTA A PULSANTE

Profilo interno
Art. ARX.13.SQ

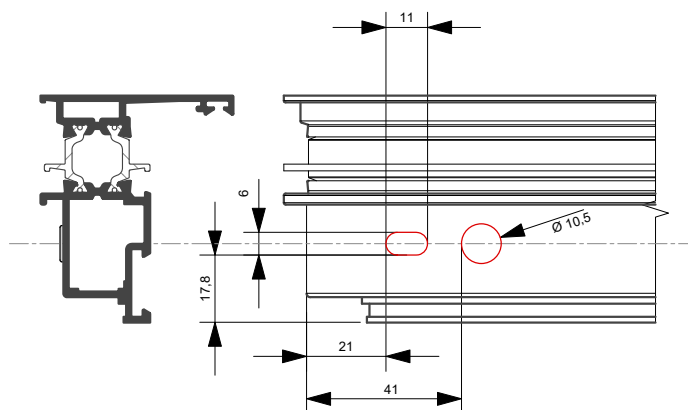
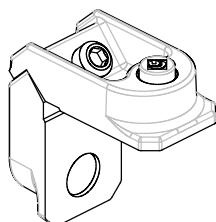

MONTAGGIO SQUADRETTA A PULSANTE

Profilo interno
Art. ACX.04.SQ (Destra e Sinistra)

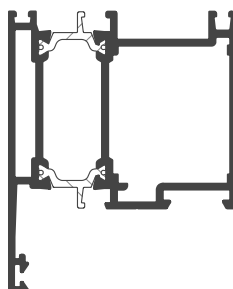
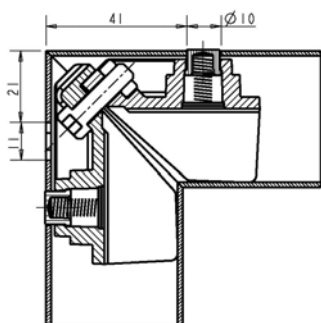
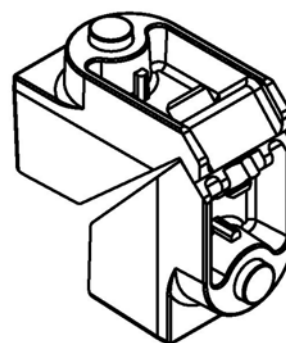

PROFILI :
.105 - .202 e similari



CIANFRINATURA

Coltello 10 mm

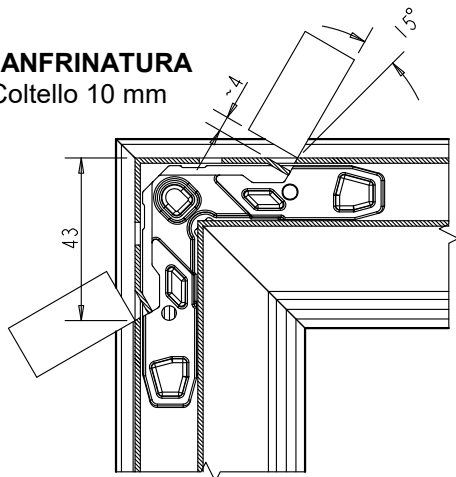

**MONTAGGIO SQUADRETTA
SPINARE, CIANFRINARE ED AVVITARE**

Art. ACX.02.SQ

AVVITATURA

VIL M5X14_D8

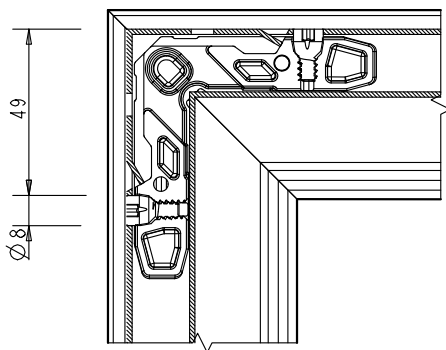

SPINATURA

SPINA ARX.07.SQ

[LM0088]

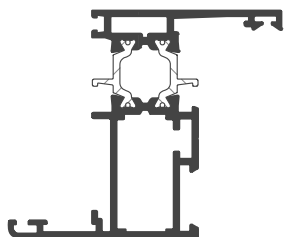
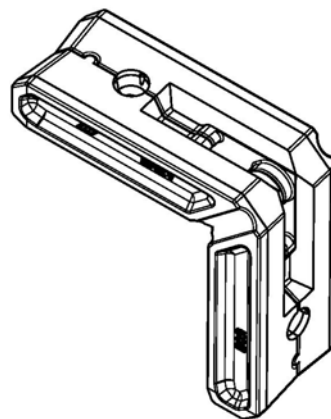
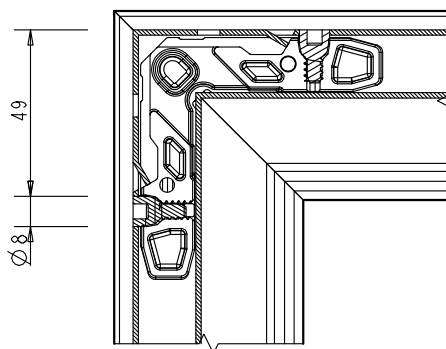

PROFILI :
.101 - .201 e similari



SPINATURA
SPINA ARX.07.SQ
[LM0088]

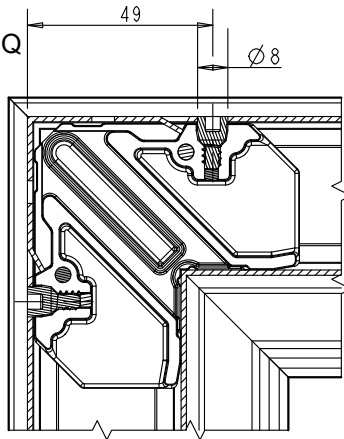

**MONTAGGIO SQUADRETTA
SPINARE, CIANFRINARE ED AVVITARE**

Art. ACX.14.SQ

AVVITATURA
VIL M5X14_D8

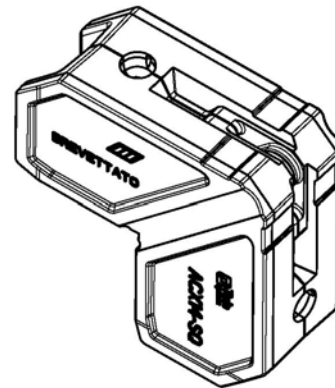
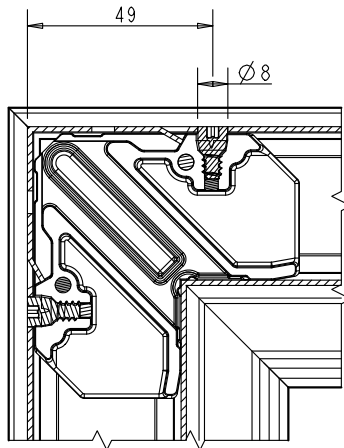

CIANFRINATURA
Coltello 10 mm

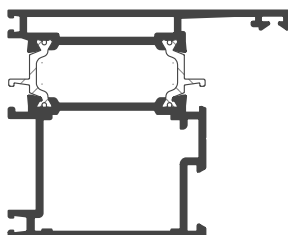
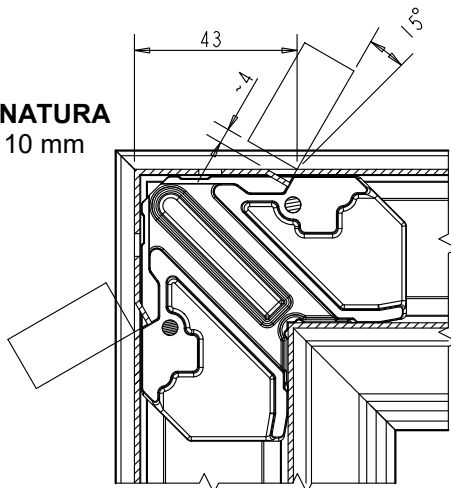

PROFILI :
.105 - .202 e similari



APPLICAZIONE ACCESSORI

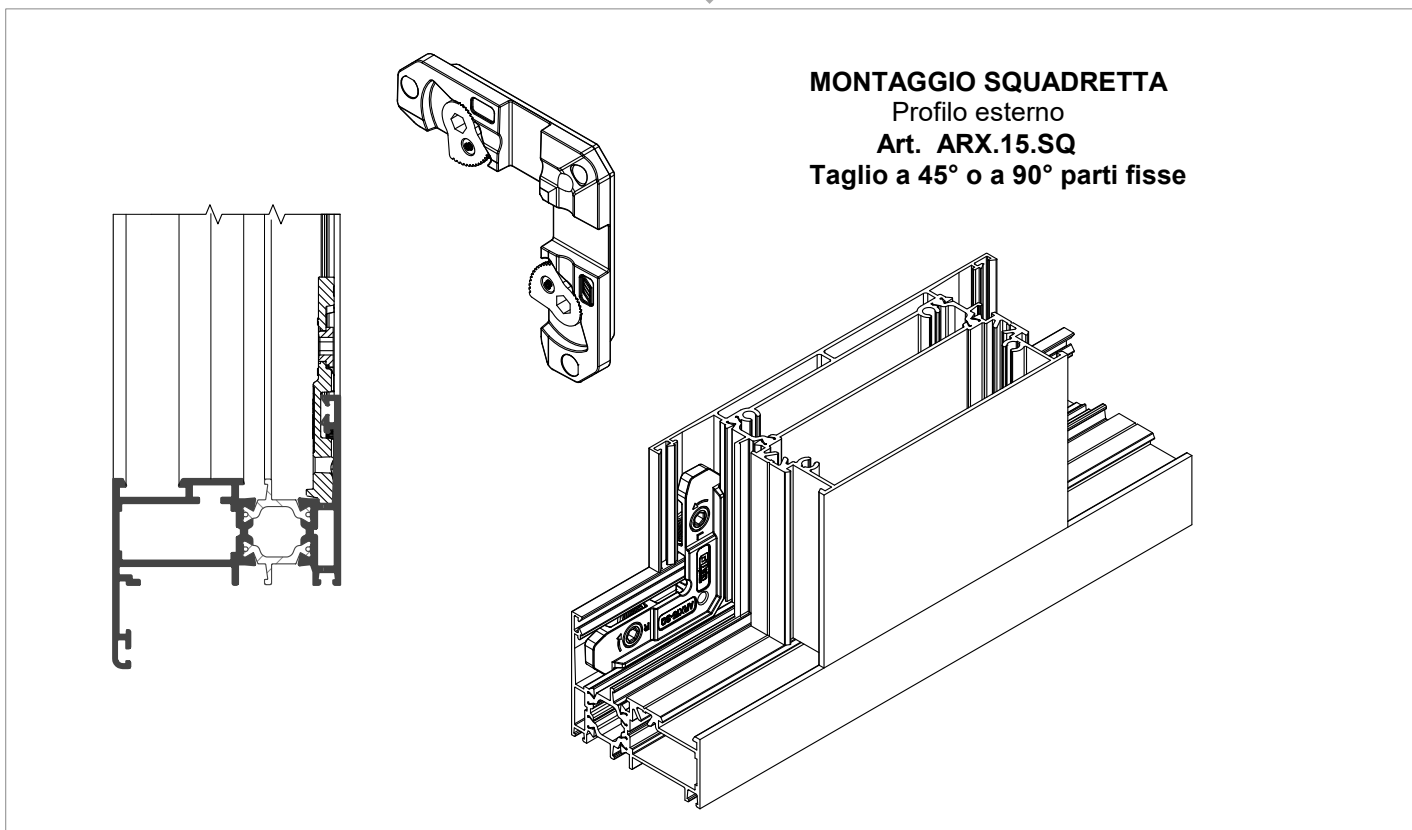

APPLICAZIONE ACCESSORI

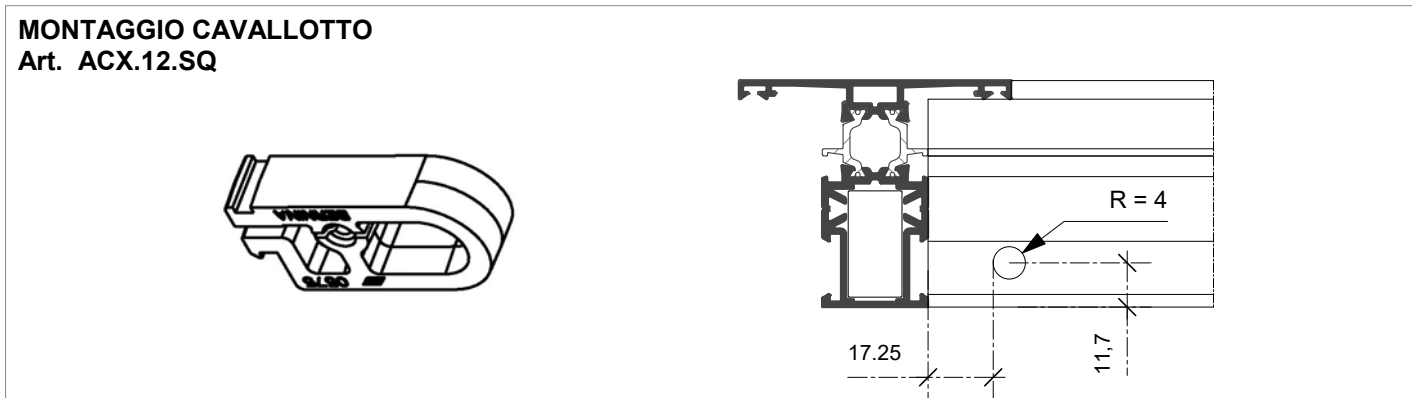

APPLICAZIONE ACCESSORI

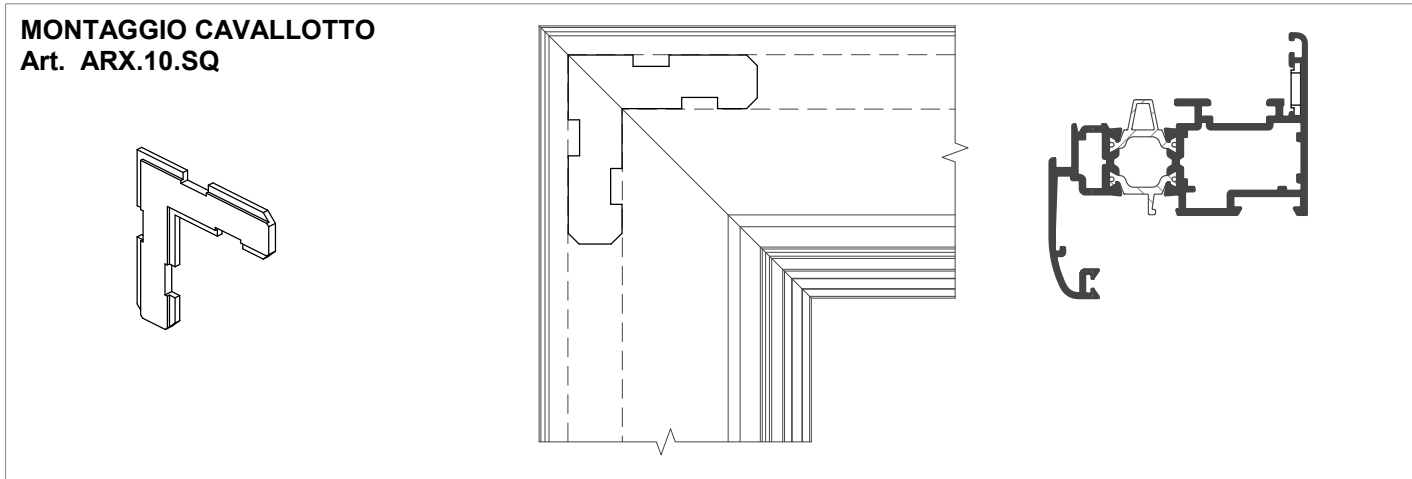



APPLICAZIONE ACCESSORI

MONTAGGIO SQUADRETTA
Art. ARX.11.SQ

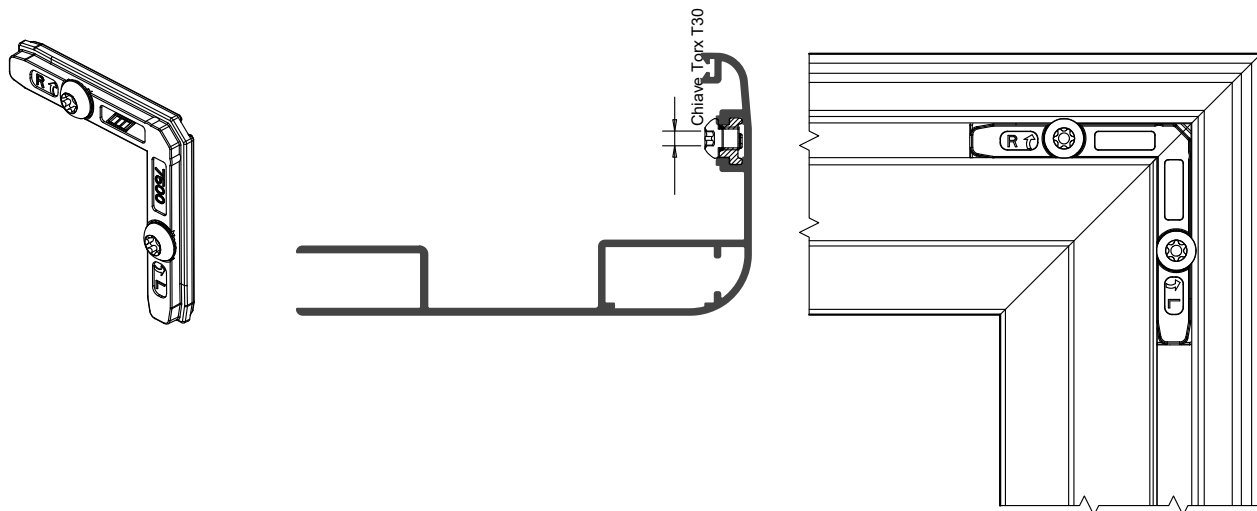

APPLICAZIONE ACCESSORI

MONTAGGIO SQUADRETTA
IN NYLON

Art. ARX.24.SQ
(alternativa alla ARX.15.SQ)

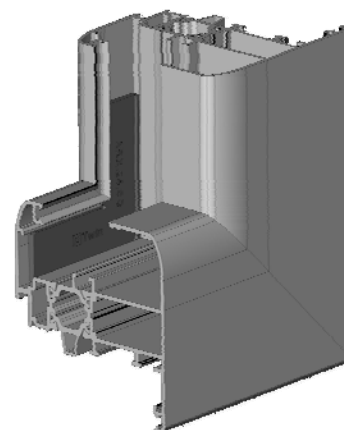

APPLICAZIONE ACCESSORI

GIUNTO PER VETRO AD INFILARE
(Fascia taglio a 90°)
Art. ACX.04.20

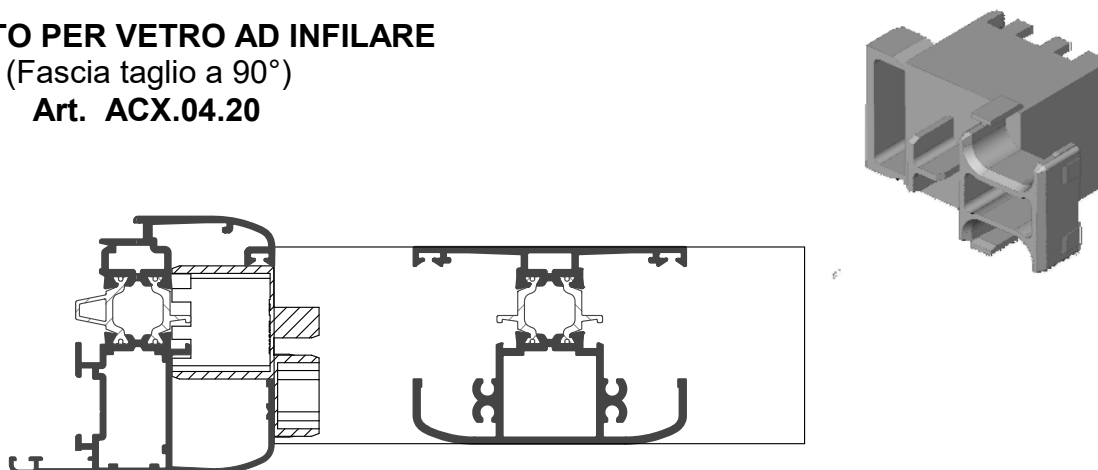



APPLICAZIONE ACCESSORI

ACX.03.12
Terminale asta

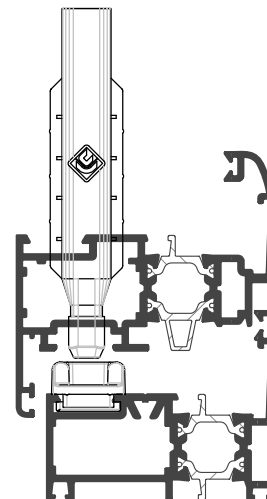
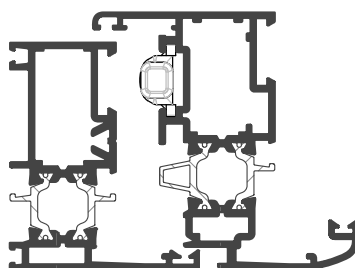

APPLICAZIONE ACCESSORI

ACX.03.18
Terminale asta in zama

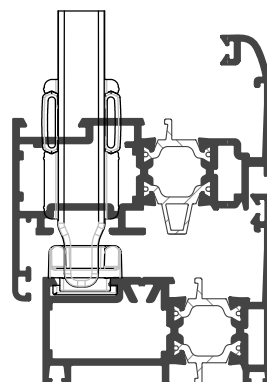
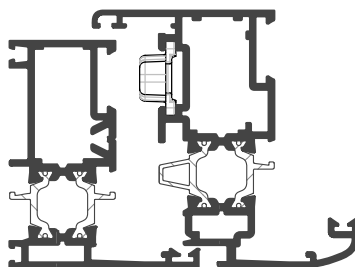
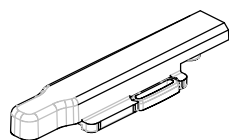

ACX.08.13
Incontro asta
singolo in zama

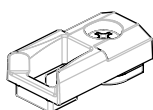



APPLICAZIONE ACCESSORI

ACX.03.11

Catenaccio a leva

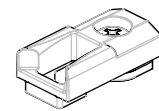
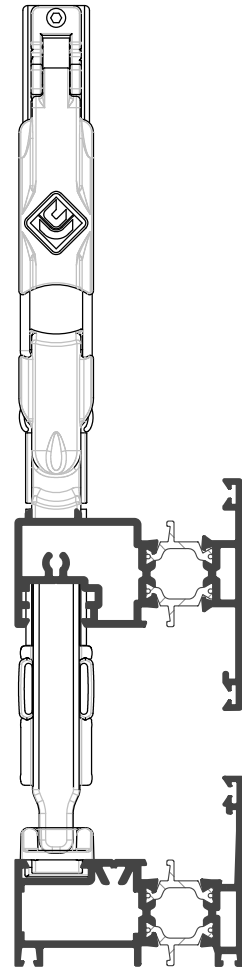
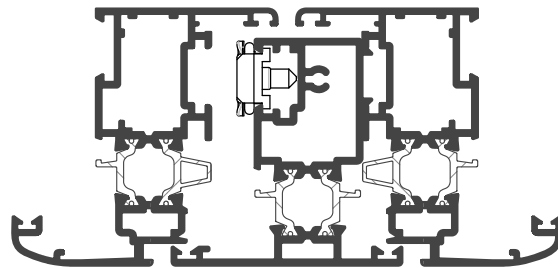
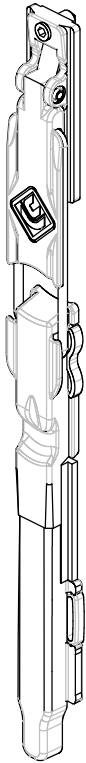

ACX.08.13

Incontro asta

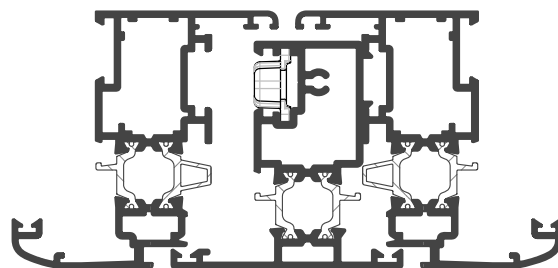



APPLICAZIONE ACCESSORI

ACX.03.16
Kit di chiusura
supplementare
con eccentrico

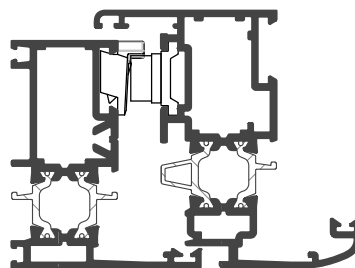
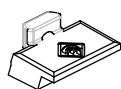

APPLICAZIONE ACCESSORI

ACX.03.63
Incontro a pozzetto d = 8 mm.

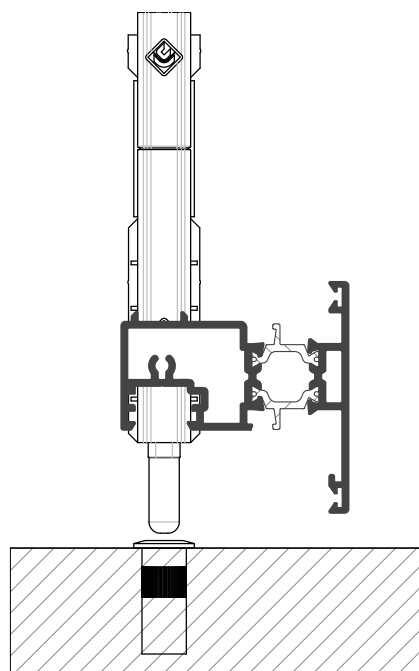
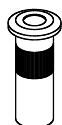

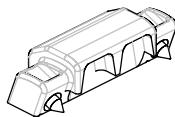
**APPLICAZIONE ACCESSORI**

ACX.03.19
Kit sostegno anta

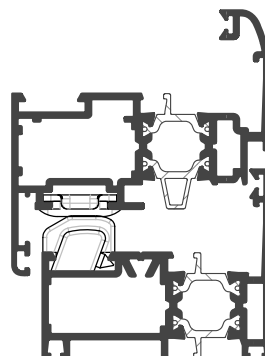
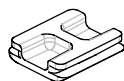
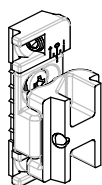
**APPLICAZIONE ACCESSORI**

ACX.03.29
Rostro regolabile

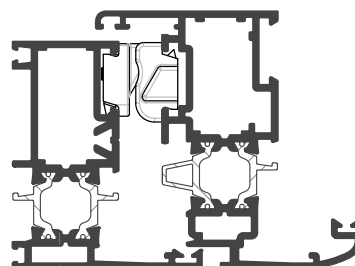
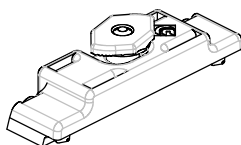
**APPLICAZIONE ACCESSORI**

ACX.03.15
Clip ferma anta

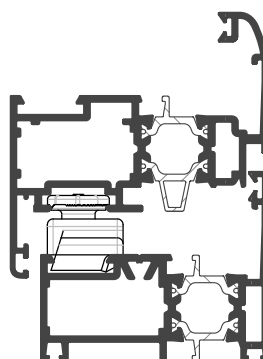



APPLICAZIONE ACCESSORI

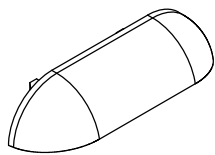

ARX.05.01
Cappetta drenaggio

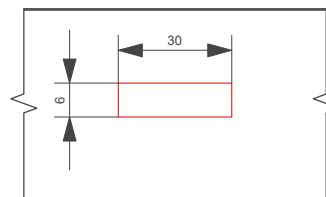
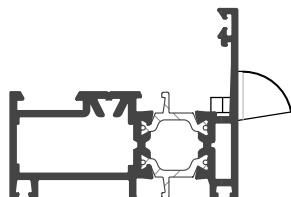

APPLICAZIONE ACCESSORI

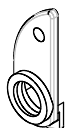

ARX.06.02
Piastrina registro telaio



ARX.06.03
Registro telaio mm.20

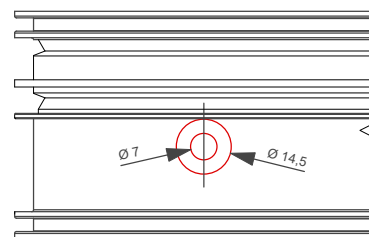
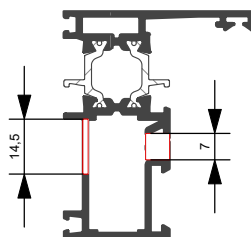
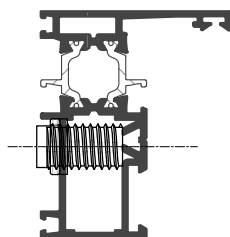

APPLICAZIONE ACCESSORI



ARX.06.01
Registro telaio universale

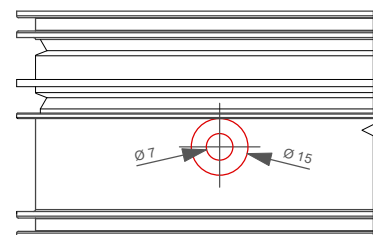
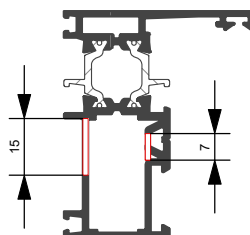
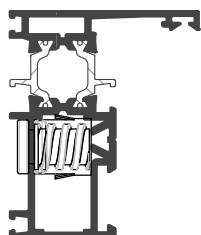



APPLICAZIONE ACCESSORI

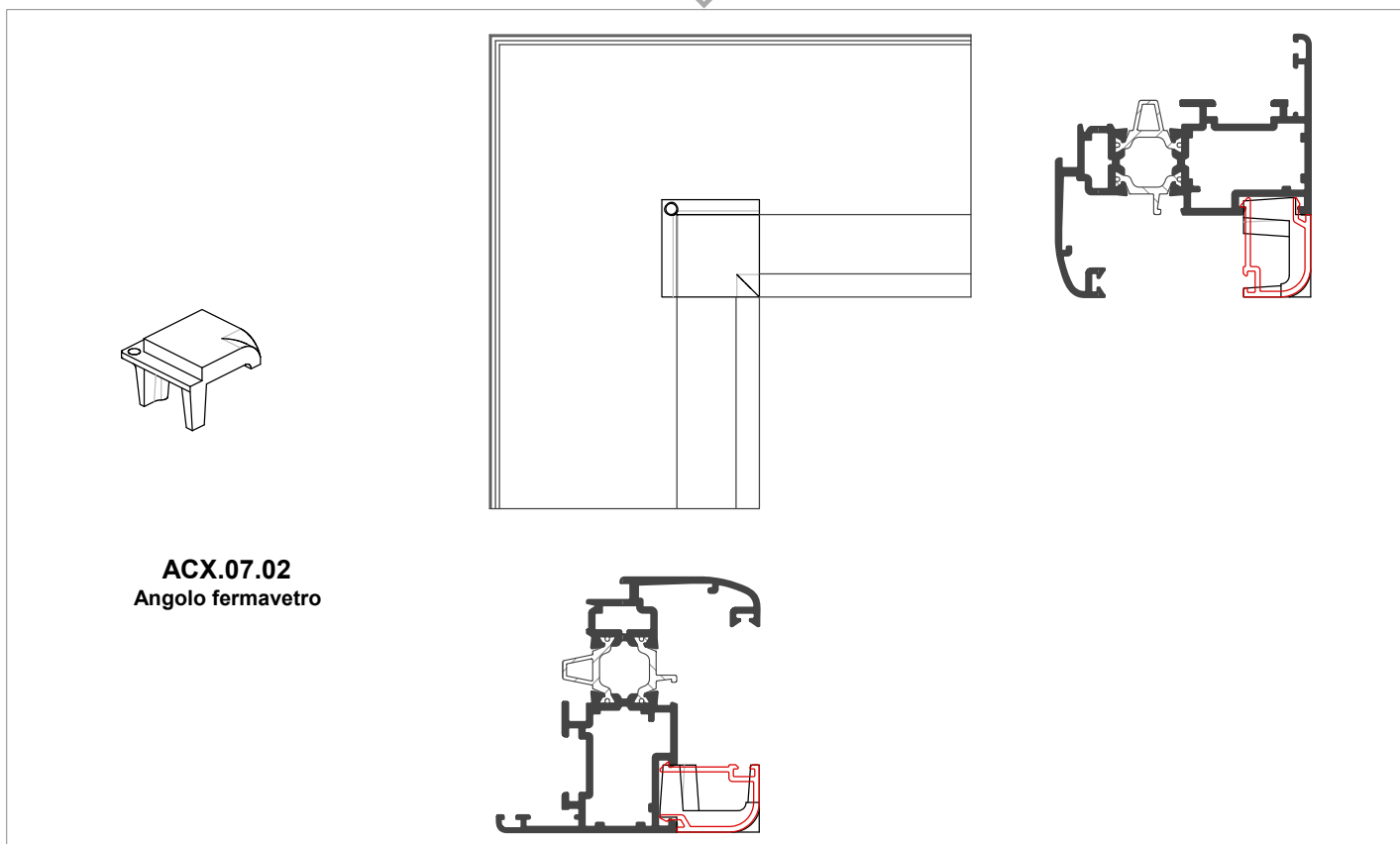

ACX.07.02
Angolo fermavetro

APPLICAZIONE ACCESSORI

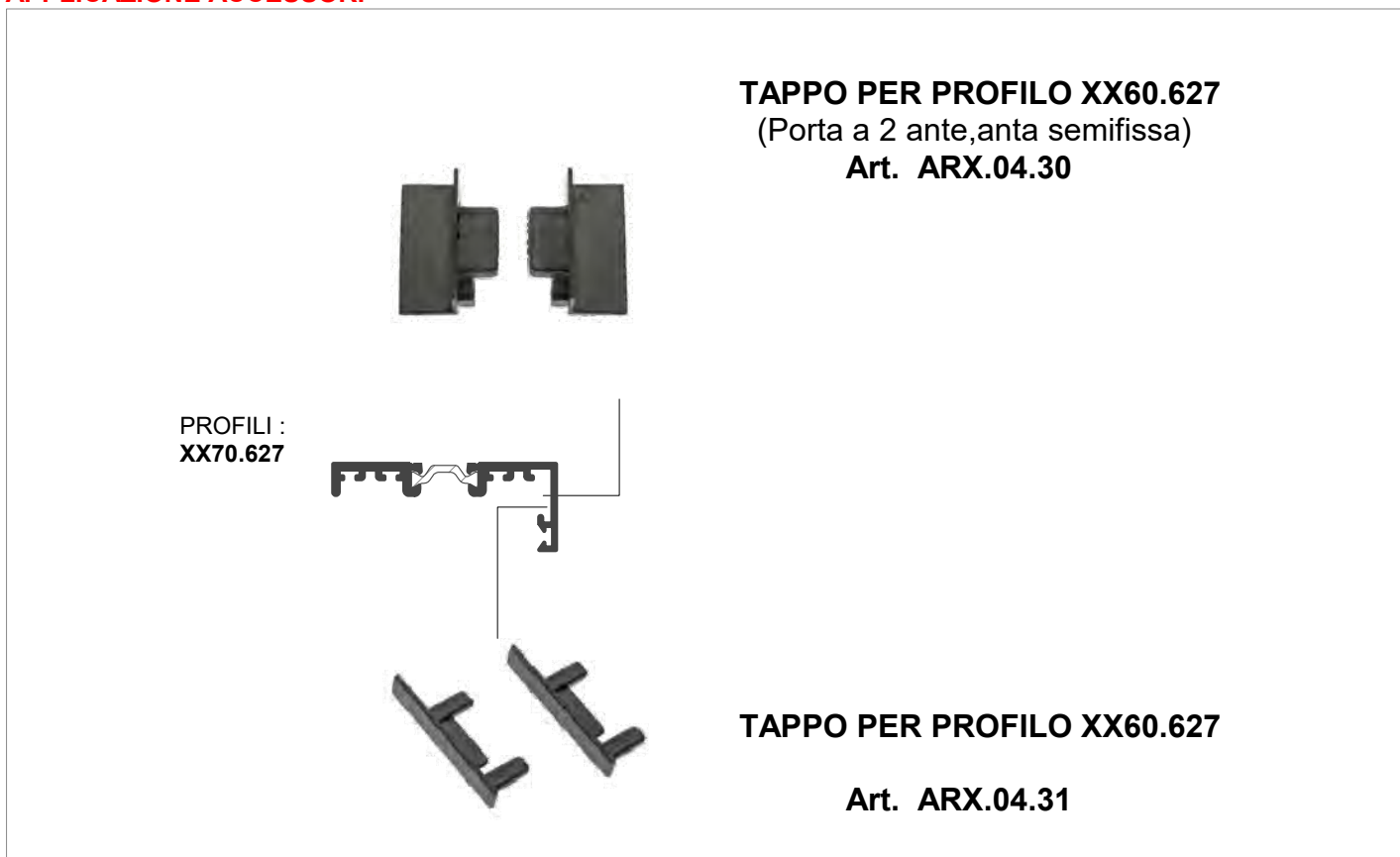

TAPPO PER PROFILO XX60.627
(Porta a 2 ante, anta semifissa)
Art. ARX.04.30

PROFILI :
XX70.627

TAPPO PER PROFILO XX60.627
Art. ARX.04.31



APPLICAZIONE ACCESSORI

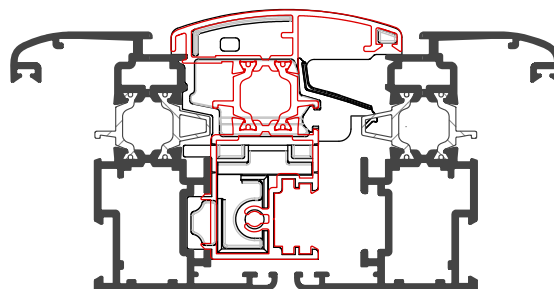
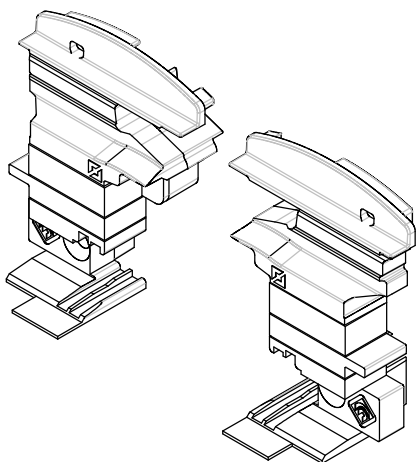

ACX.04.01HP
Coppia tappi
di riporto

APPLICAZIONE ACCESSORI

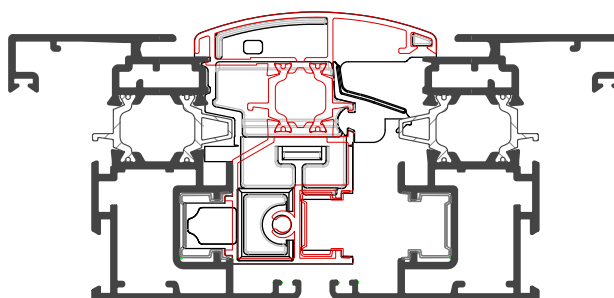
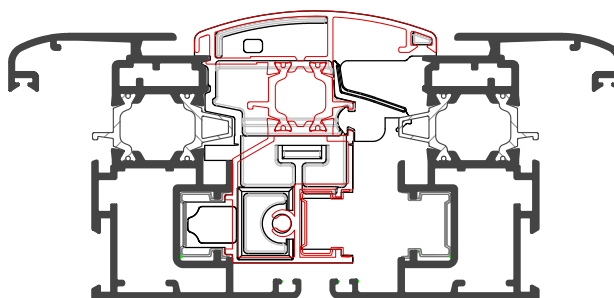
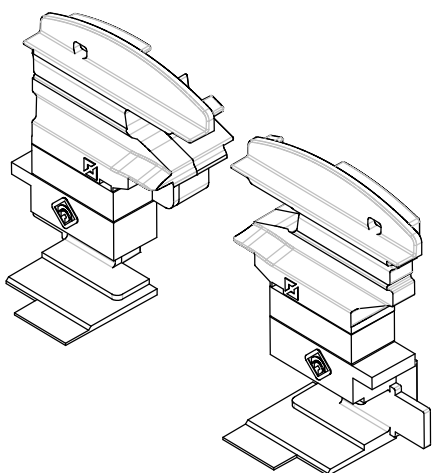

ARX.04.02HP
Coppia tappi
di riporto



APPLICAZIONE ACCESSORI

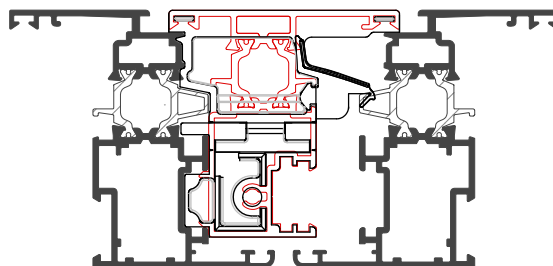
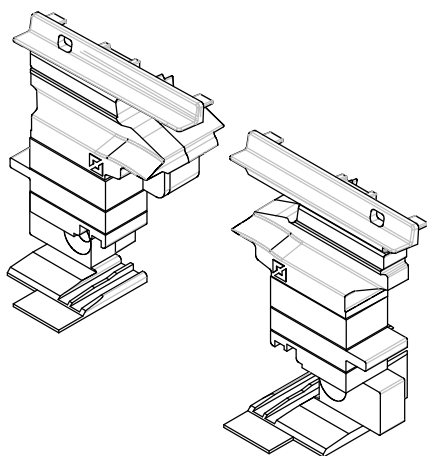

ACX.04.03HP
Coppia tappi
di riporto

APPLICAZIONE ACCESSORI

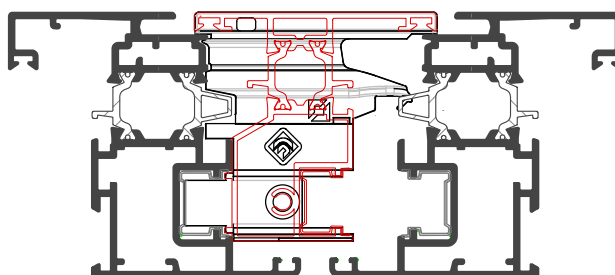
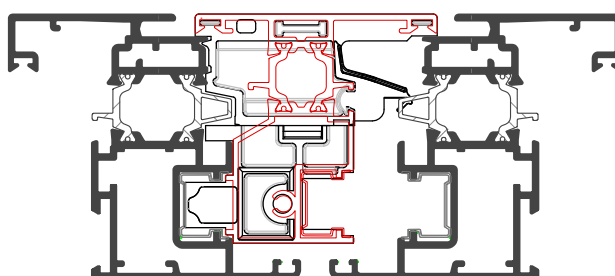
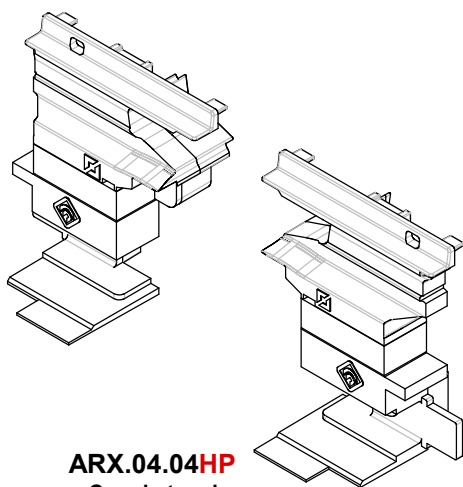

ARX.04.04HP
Coppia tappi
di riporto



APPLICAZIONE ACCESSORI

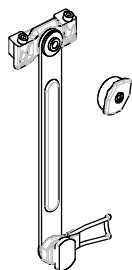

ACX.02.08
Braccio limitatore
altezza anta da 260mm a 800mm

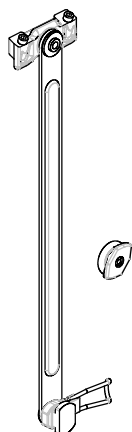

ACX.02.07
Braccio limitatore
altezza anta da 600mm a 1600mm

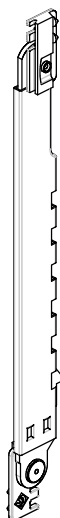

ACX.02.09
Braccio telescopico a scatto

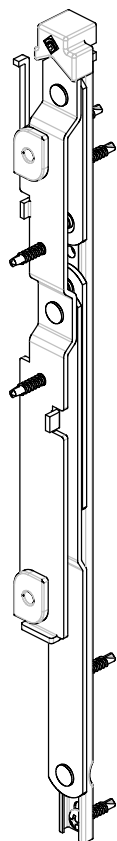
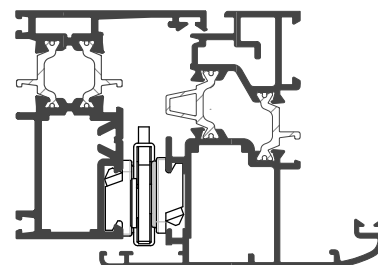
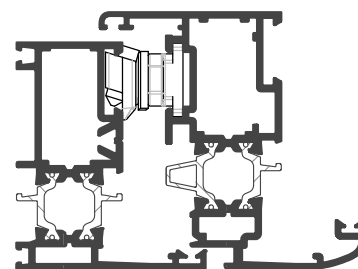

ACX.02.10
Cerniera a compasso

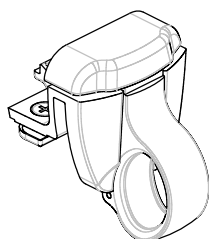
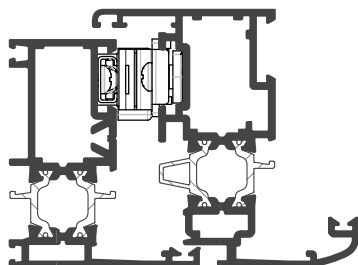

ACX.03.01
Cricchetto ad aggancio con piastrine
per telai sormonto

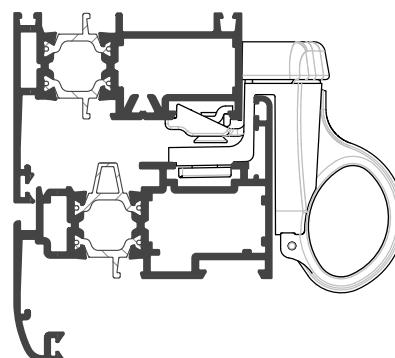



APPLICAZIONE ACCESSORI

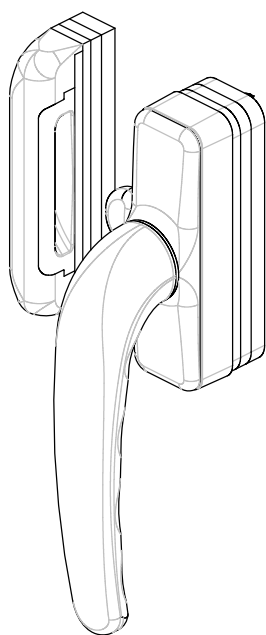
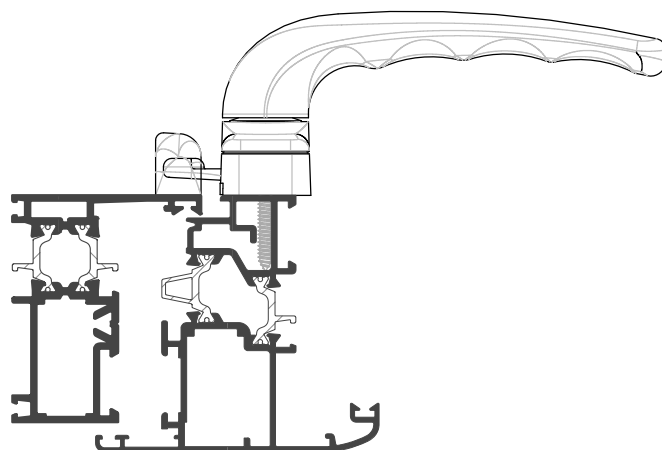

ARX.03.02
Maniglia a tavellino

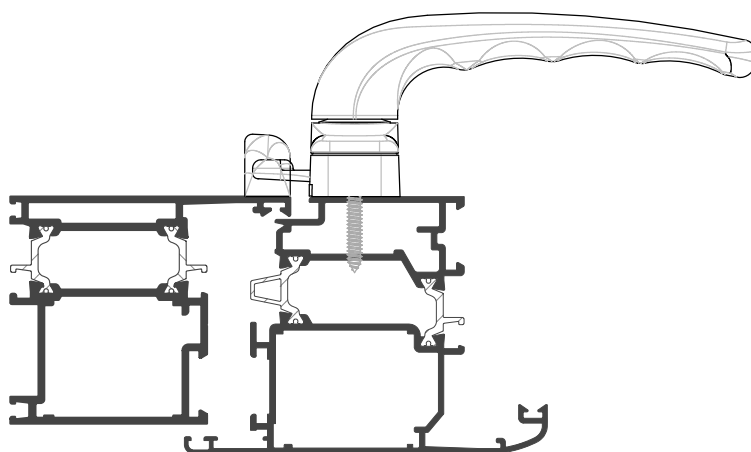



APPLICAZIONE ACCESSORI

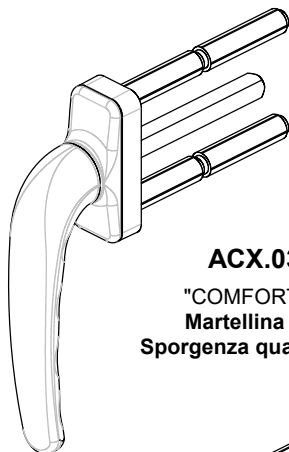

ACX.03.73
"COMFORT MINI"
Martellina ridotta
Sporgenza quadro mm.70

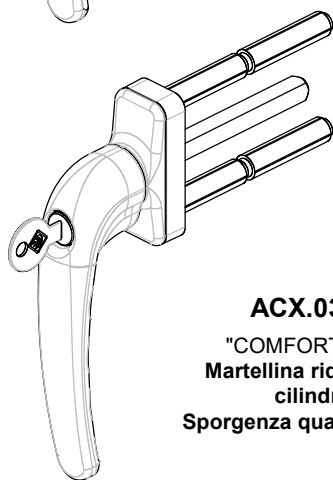
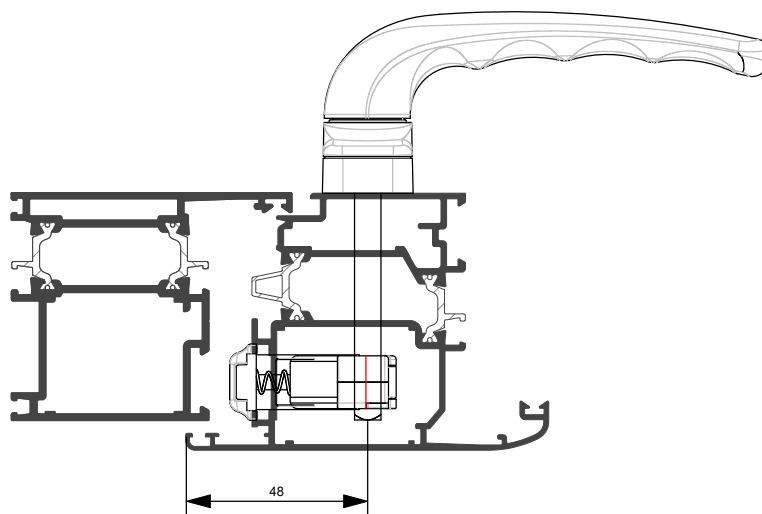

ACX.03.74
"COMFORT MINI"
Martellina ridotta con
cilindro
Sporgenza quadro mm.70

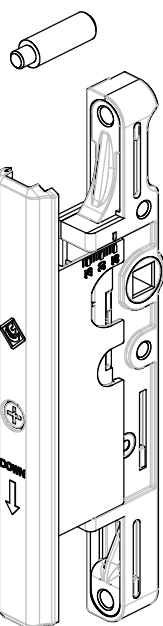
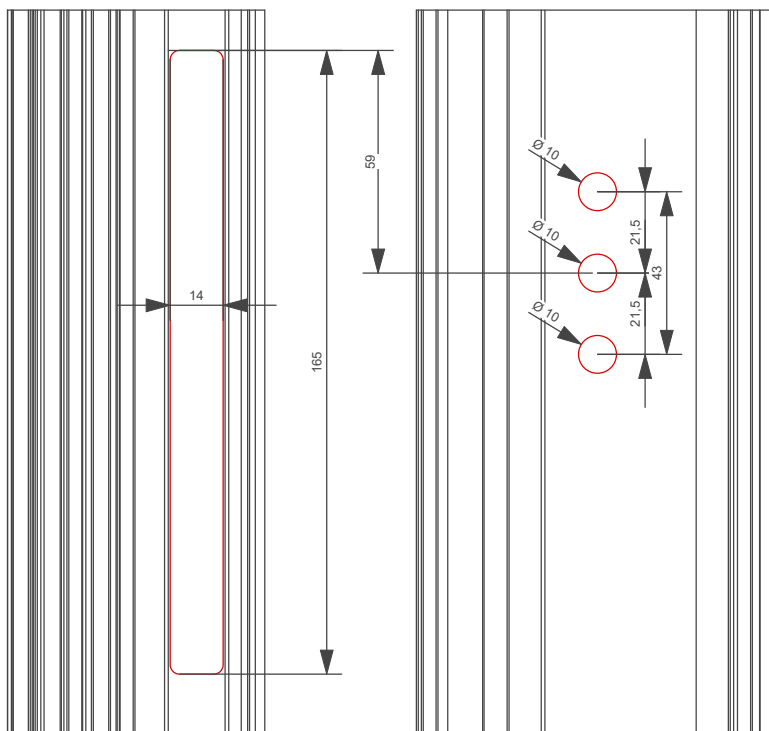

ARX.03.67
Perno di trascinamento
L = 27 mm.

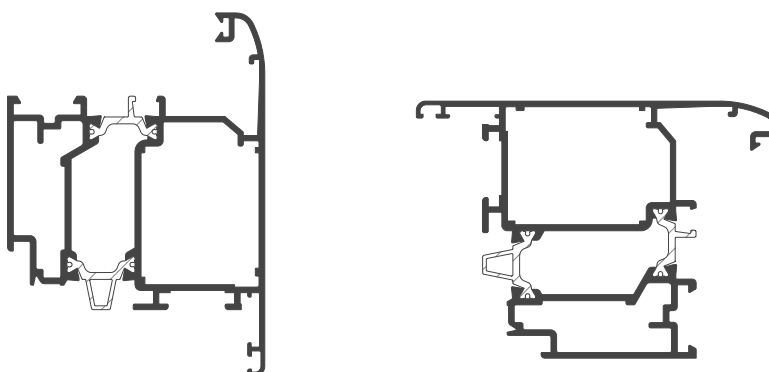

ACX.03.72
Movimentazione Bidirezionale
Interasse 23 - 35 mm.



APPLICAZIONE ACCESSORI

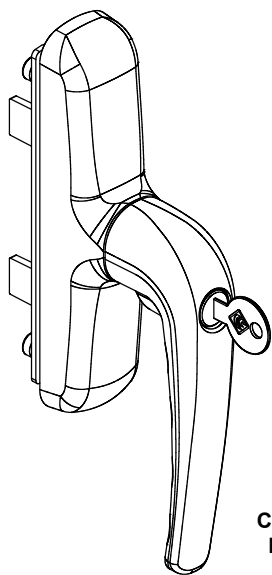

ARX.03.07
Cremonese con chiave
Interasse 84 - 92 - 104

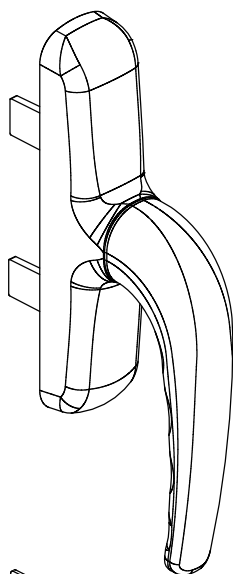
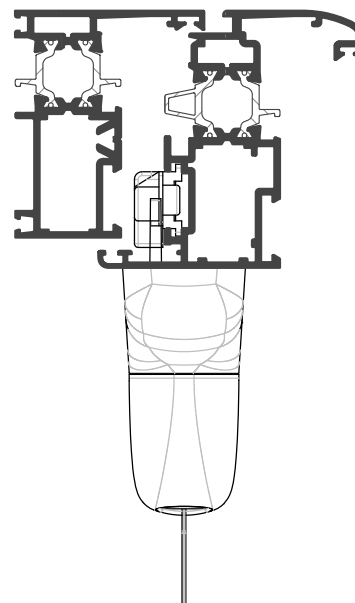
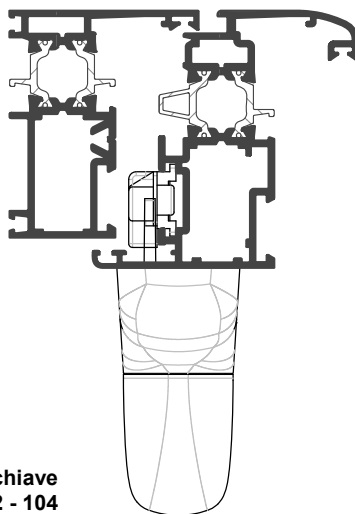

ARX.03.06
Cremonese
Interasse 84 - 92 - 104

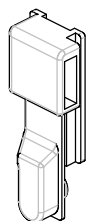
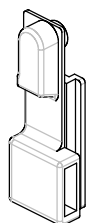
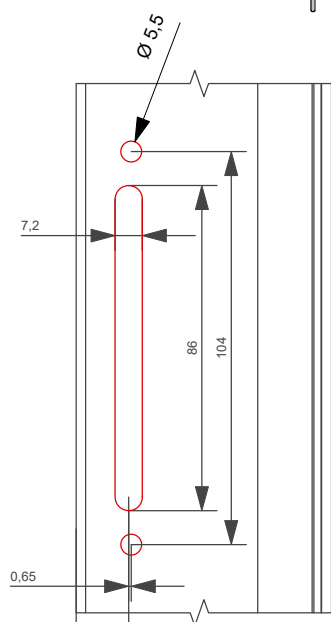

ACX.03.17
Innesti cremonese

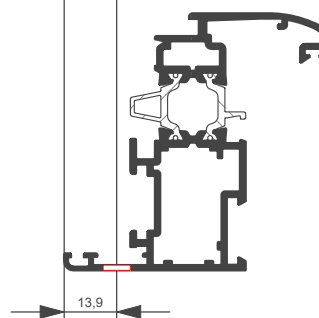



APPLICAZIONE ACCESSORI

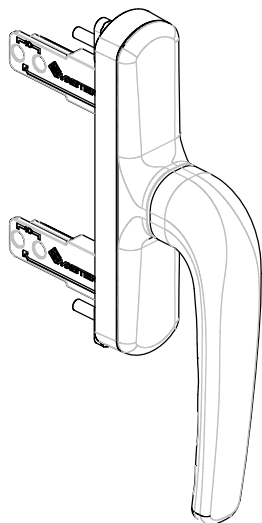

ARX.03.47

Cremonese apertura
esterna - int. 28/65mm

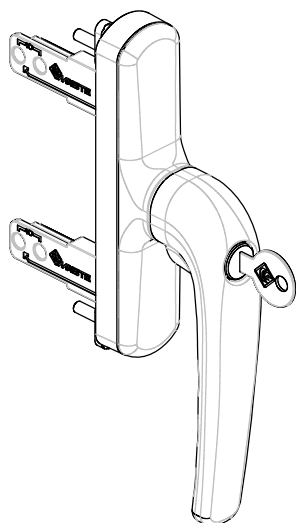
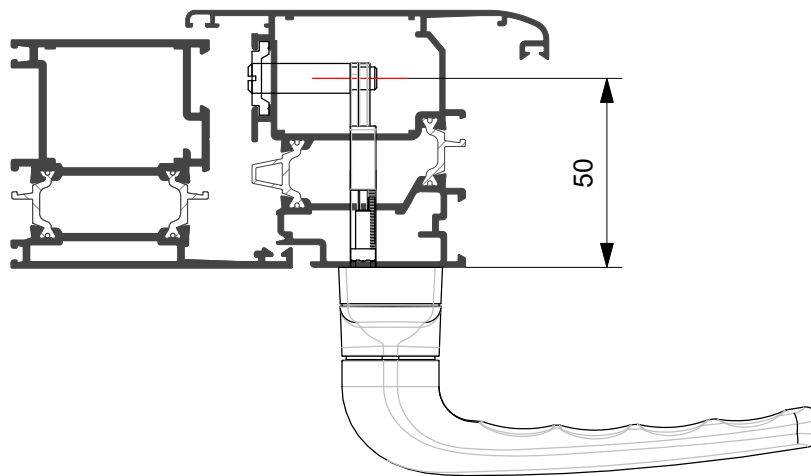

ARX.03.48

Cremonese apertura esterna
con chiave - int. 38/65mm

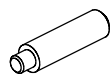
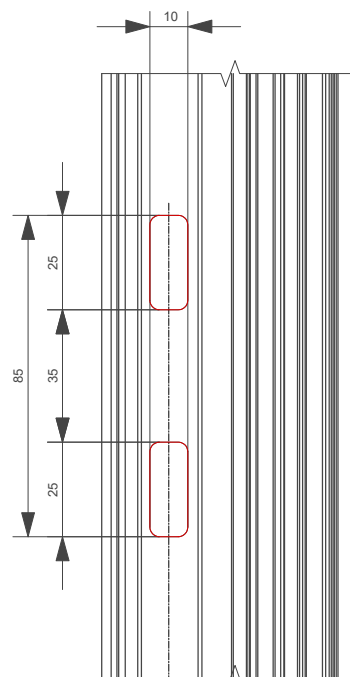
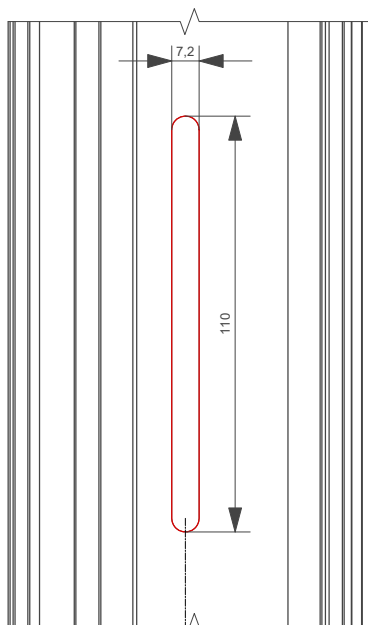

ACX.03.67

Perno di trascinamento
L=27mm

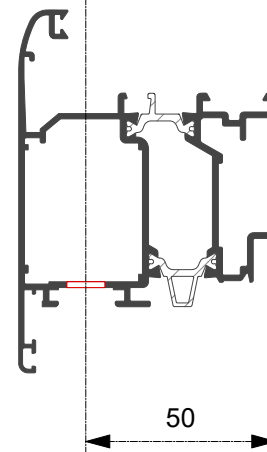
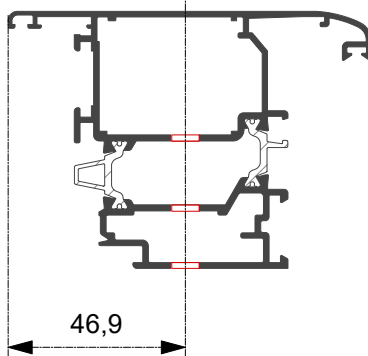



APPLICAZIONE ACCESSORI

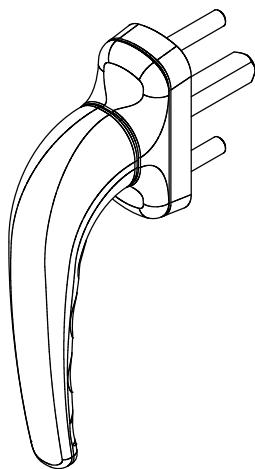

ARX.03.04

Martellina

Sporgenza quadro mm.24

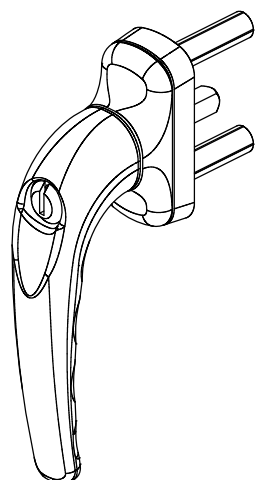

ARX.03.05

Martellina con chiave

Sporgenza quadro mm.24

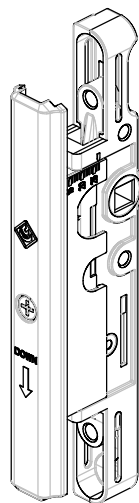

ARX.03.09

Movimentazione bidirezionale
regolabile 15 - 27 mm.



ACX.03.66

Perno 11 mm.

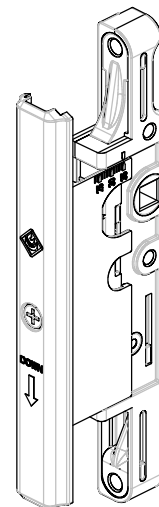

ACX.03.72

Movimentazione bidirezionale
regolabile 23 - 35 mm.

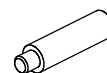

ACX.03.67

Perno 27 mm.

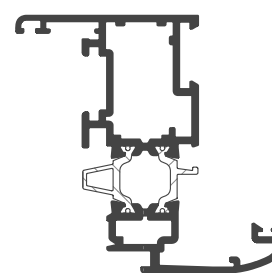
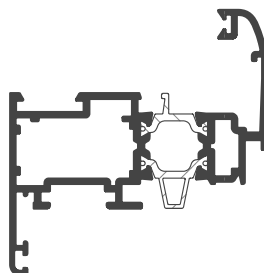
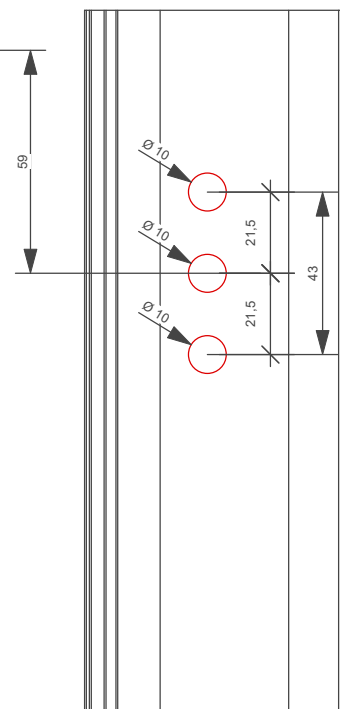
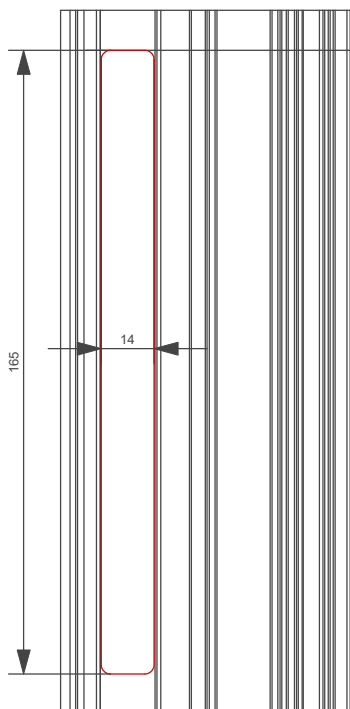
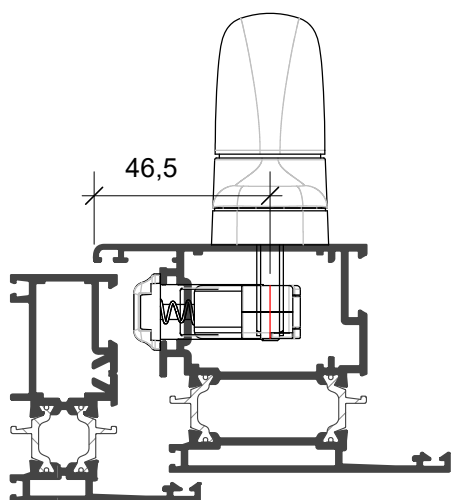
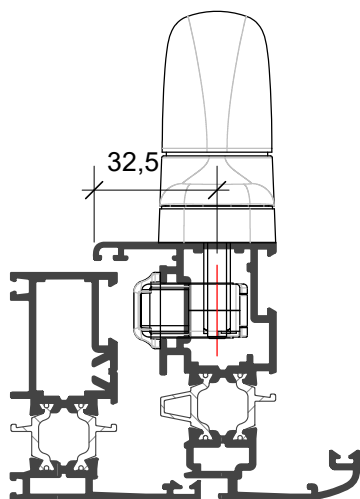



APPLICAZIONE ACCESSORI

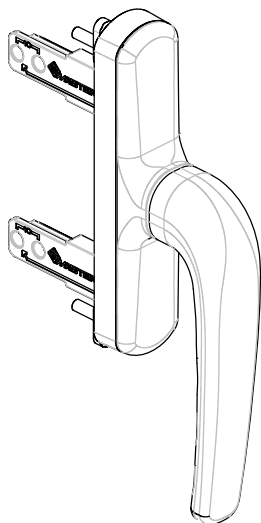

ARX.03.47

Cremonese apertura
esterna - int. 28/65mm

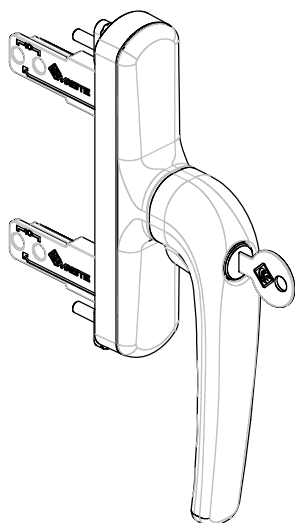
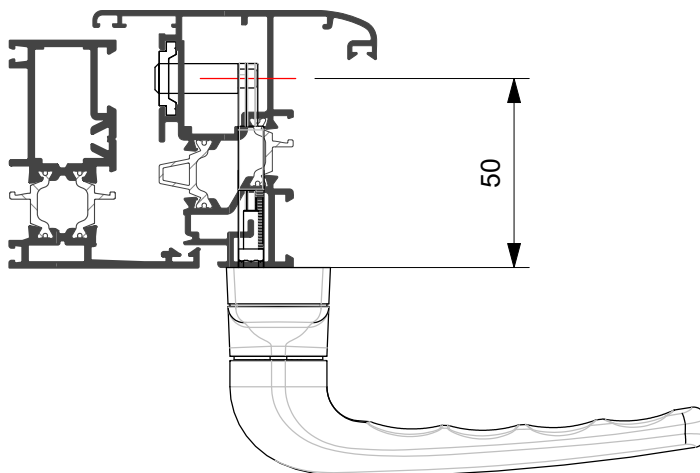

ARX.03.48

Cremonese apertura esterna
con chiave - int. 38/65mm

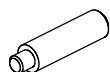
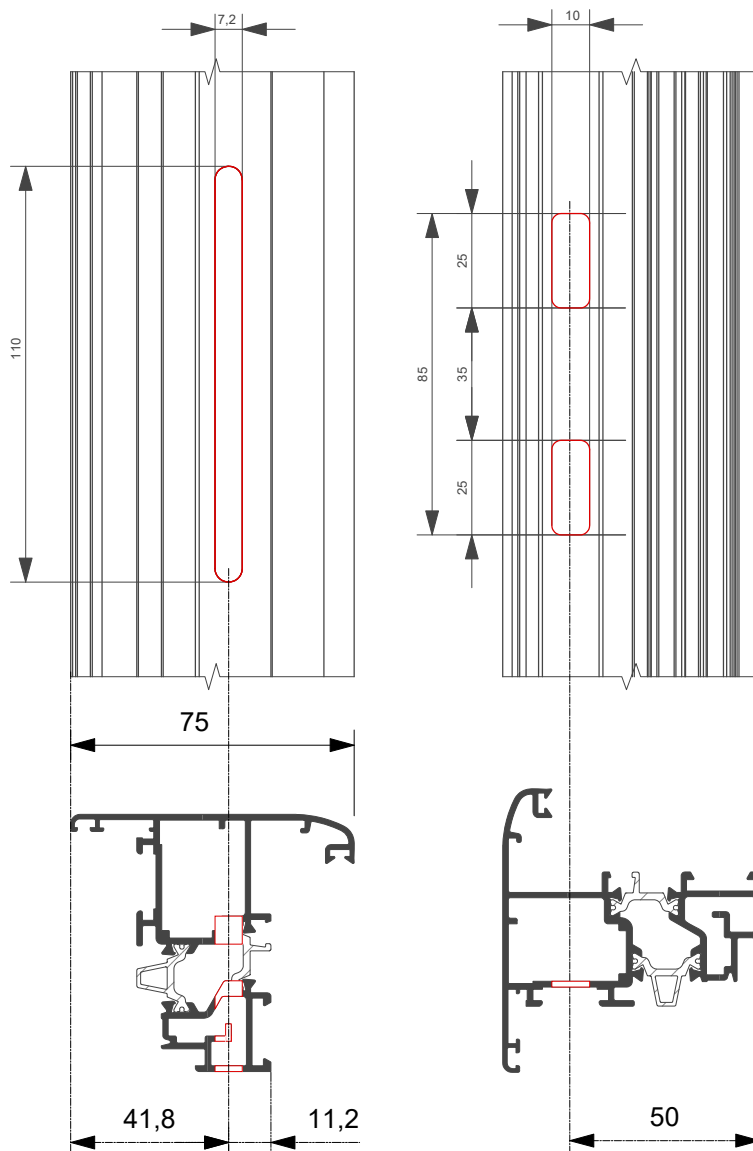

ARX.03.45

Perno di trascinamento
L=22mm



APPLICAZIONE ACCESSORI

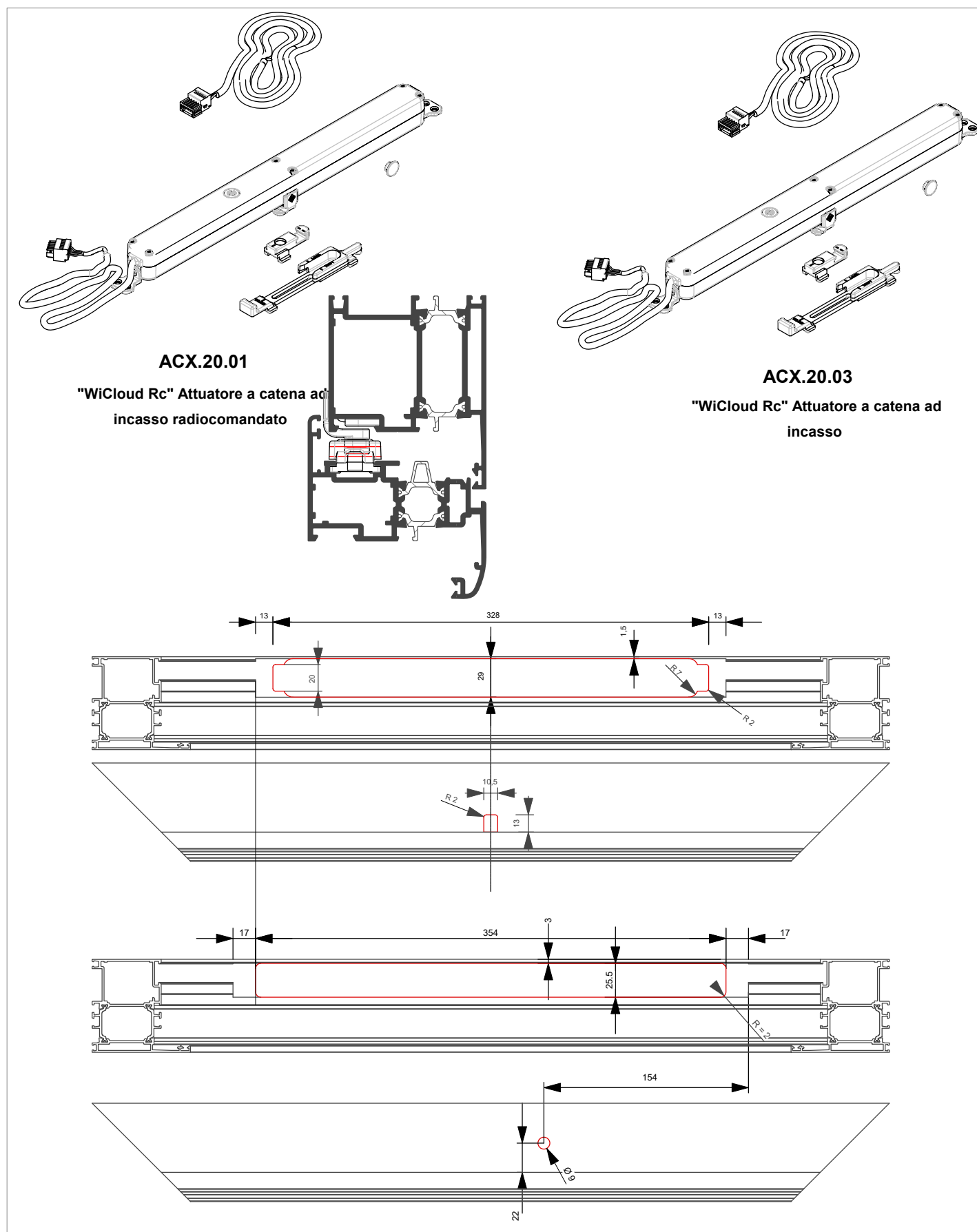

NB. Maggiori idettagli di montaggio nella confezione



APPLICAZIONE ACCESSORI

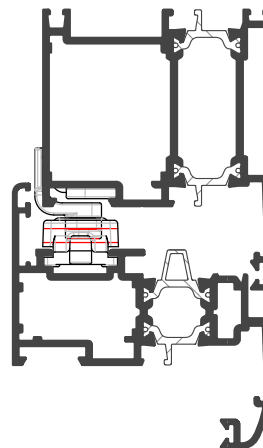
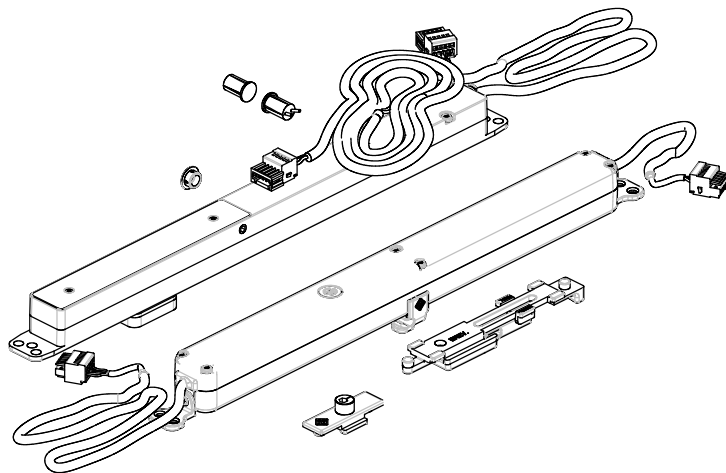

ACX.20.04

"WiCloud Rc - Lock"

Attuatore a catena radiocomandato + serratura elettromeccanica

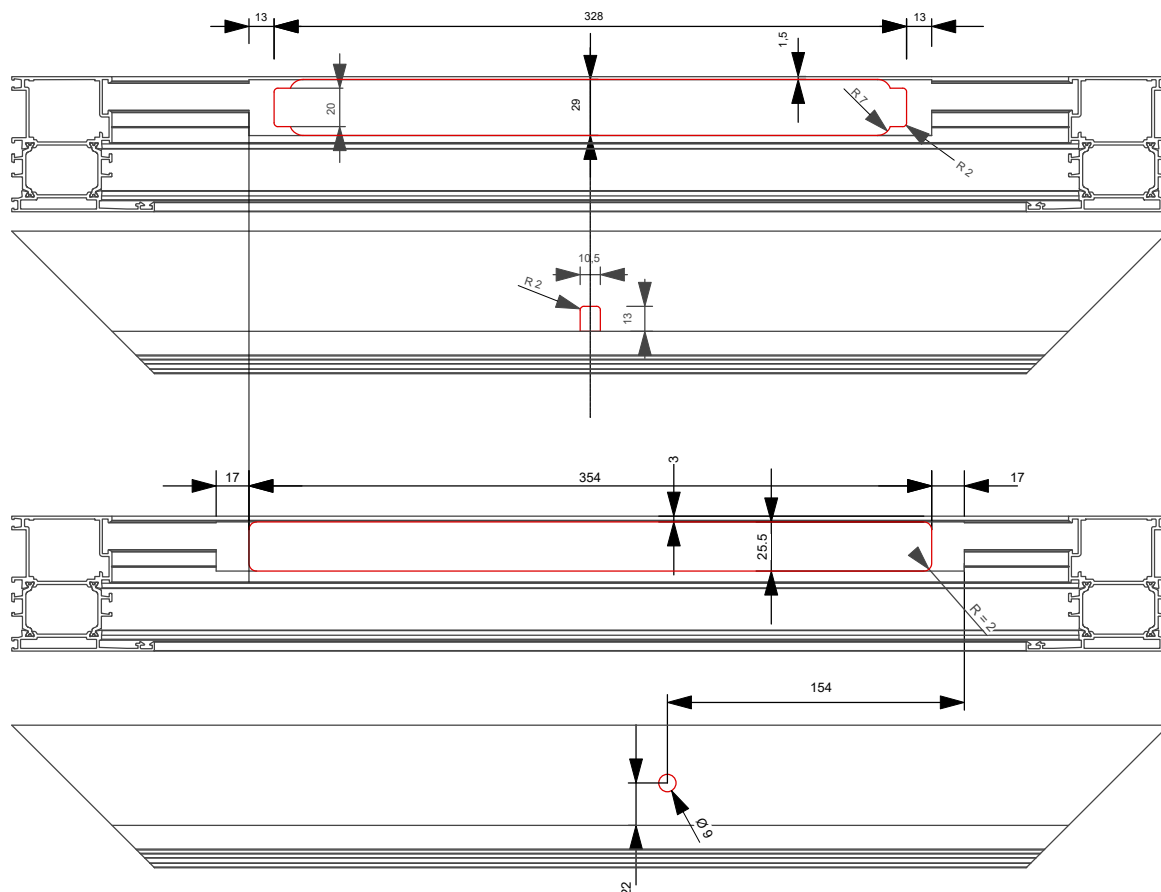

NB. Maggiori idettagli di montaggio nella confezione



GRUPPO FRESA
Art. ACX.09.02

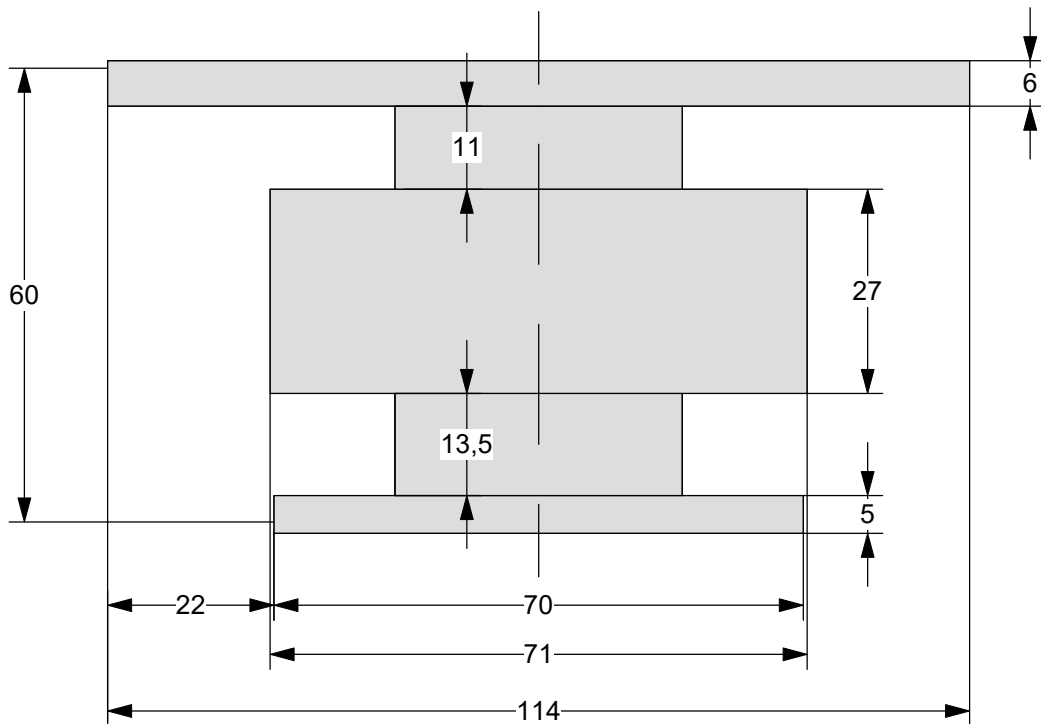
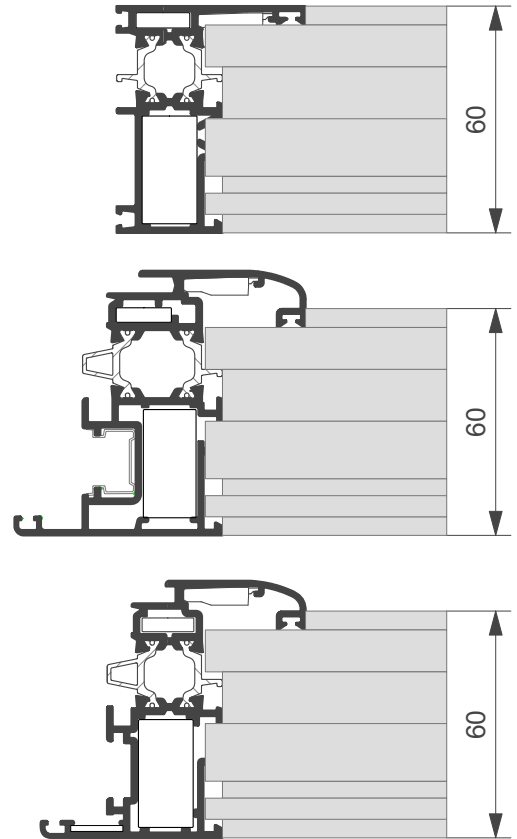



APPLICAZIONE ACCESSORI

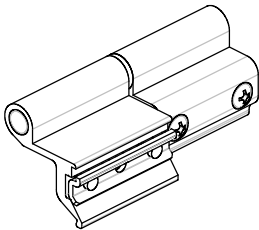

ACX.02.01

Cerniera a montaggio rapido a 2 ali

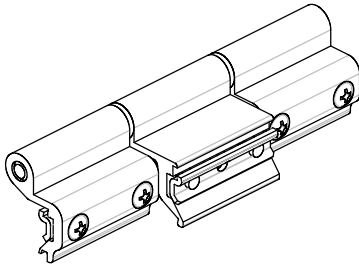

ACX.02.03

Cerniera a montaggio rapido a 3 ali

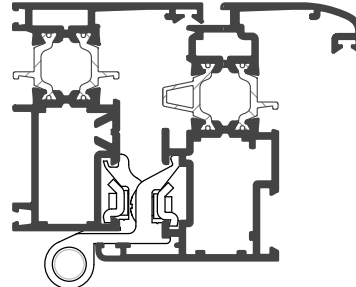

APPLICAZIONE ACCESSORI

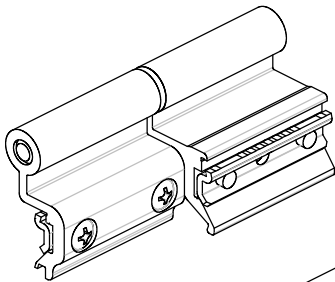

ACX.02.02

Cerniera a montaggio rapido a 2 ali

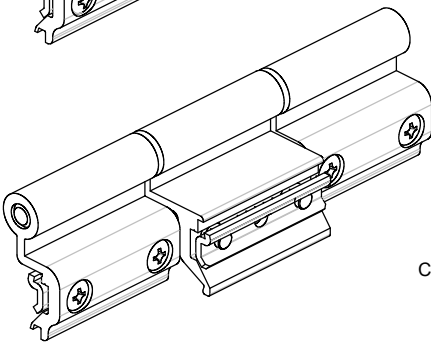

ACX.02.04

Cerniera a montaggio rapido a 3 ali

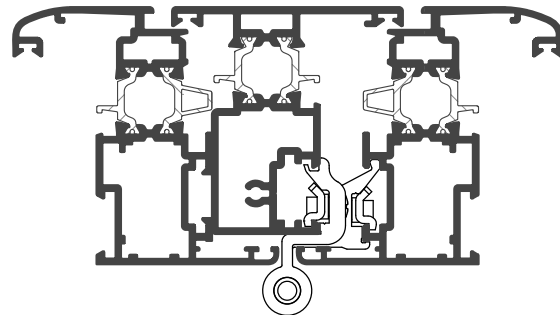

APPLICAZIONE ACCESSORI

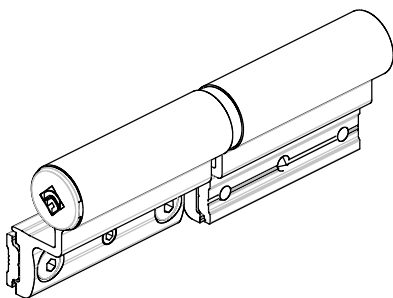

ACX.02.11

Cerniera porte a 2 ali

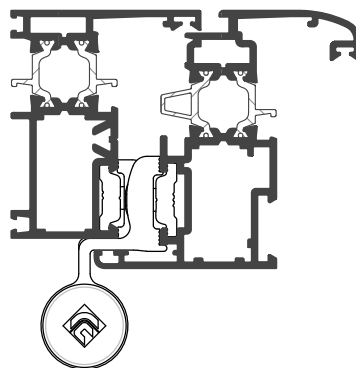



APPLICAZIONE ACCESSORI

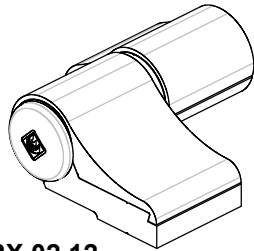
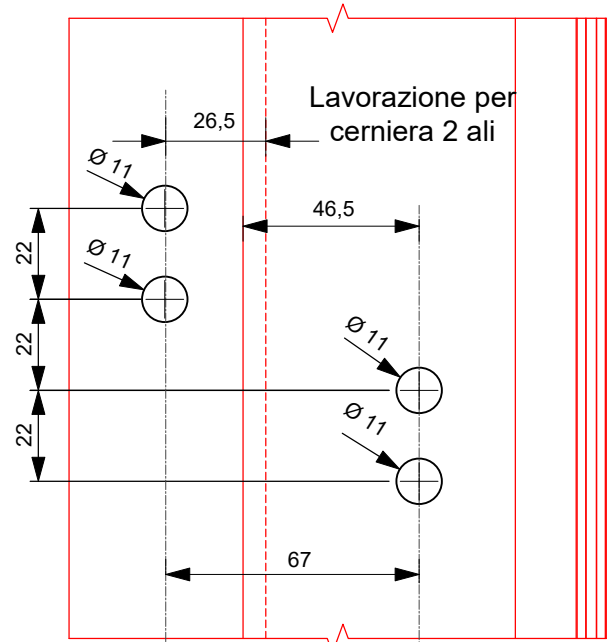
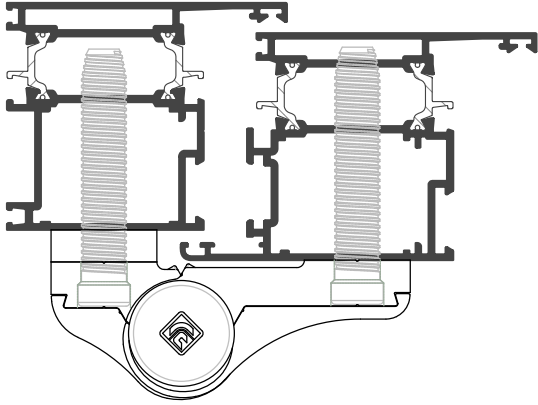

ARX.02.12

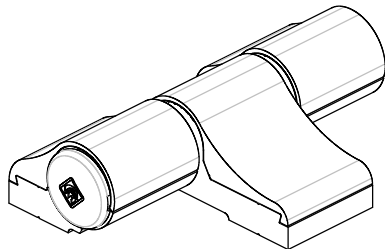
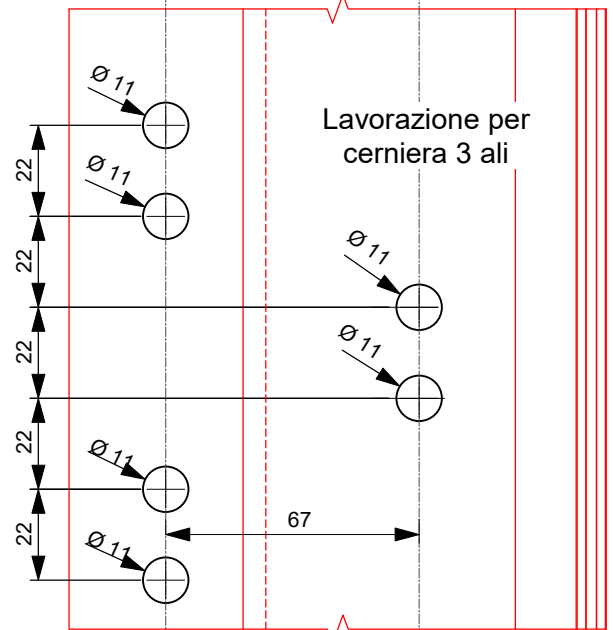

ARX.02.13

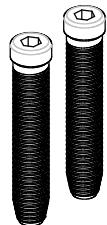

ARX.02.23

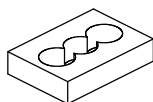
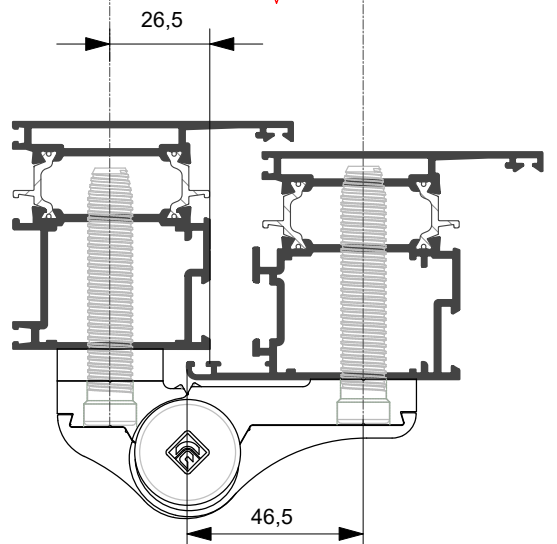

ARX.02.25



APPLICAZIONE ACCESSORI

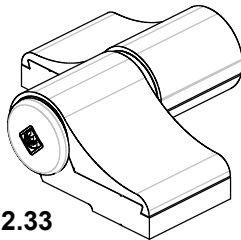
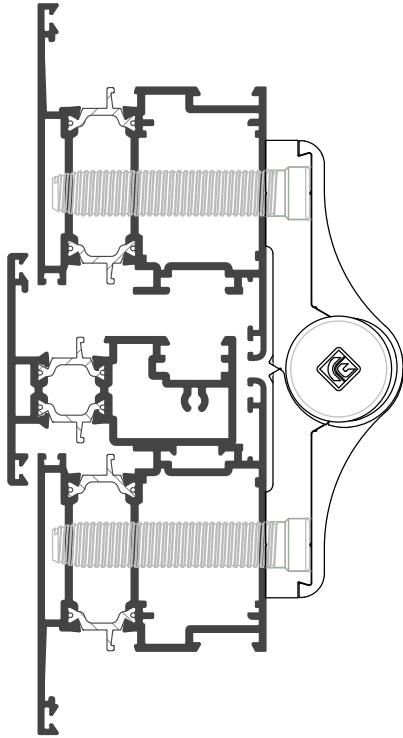

ARX.02.33

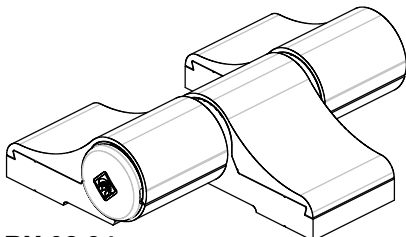

ARX.02.34

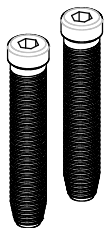

ARX.02.23

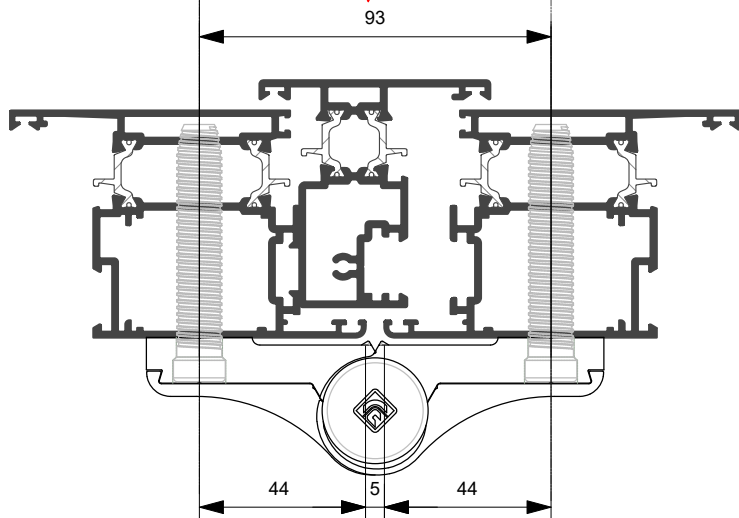
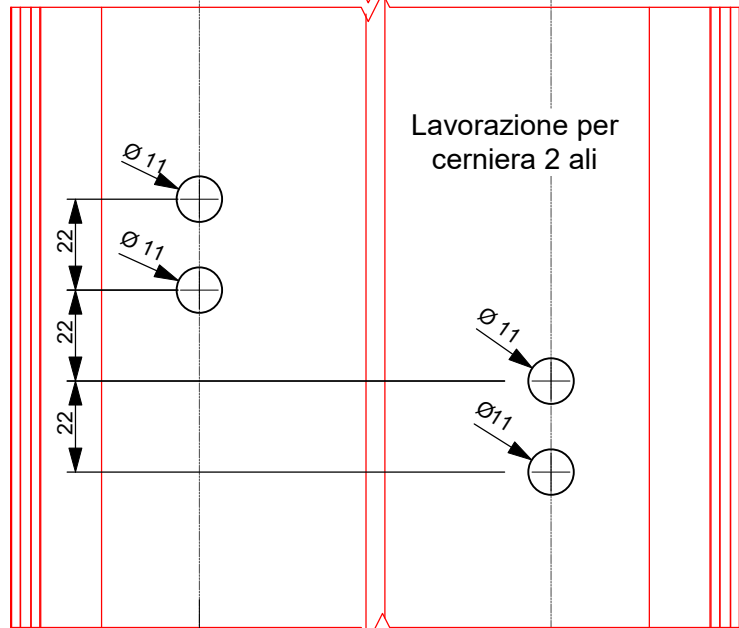
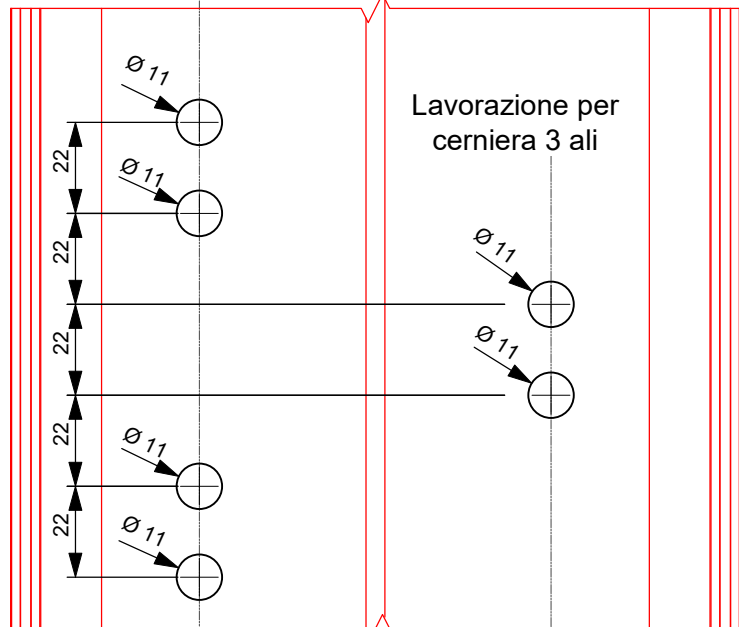



APPLICAZIONE ACCESSORI

ACX.08.39

WEEN HIDE 180- Sx/Dx Cerniera inferiore

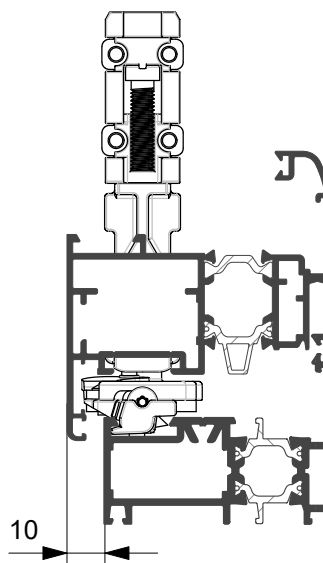
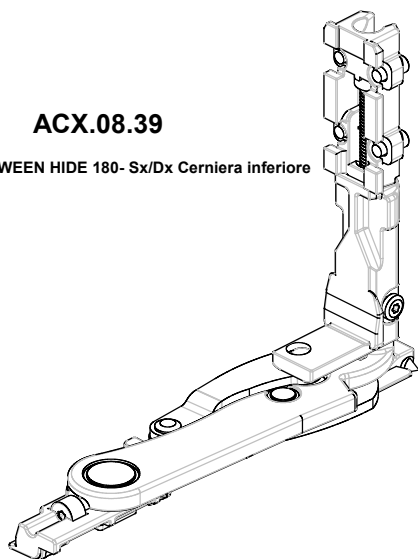

NB

Solo per anta **CX60.260** e **CX60.261**

APPLICAZIONE ACCESSORI

ACX.08.36

WEEN HIDE 180- Dx Braccio a scomparsa per apertura a battente

ACX.08.37

WEEN HIDE 180- Sx Braccio a scomparsa per apertura a battente

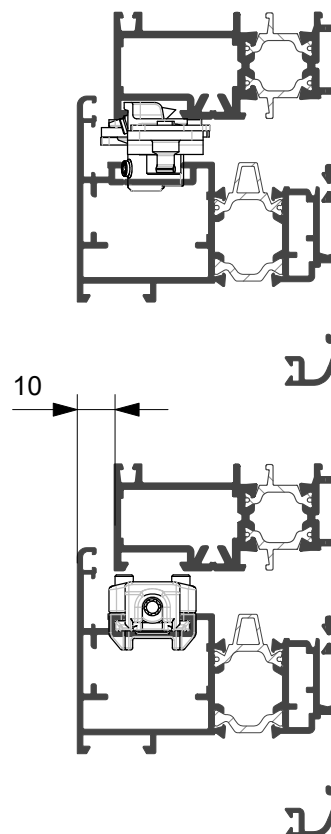
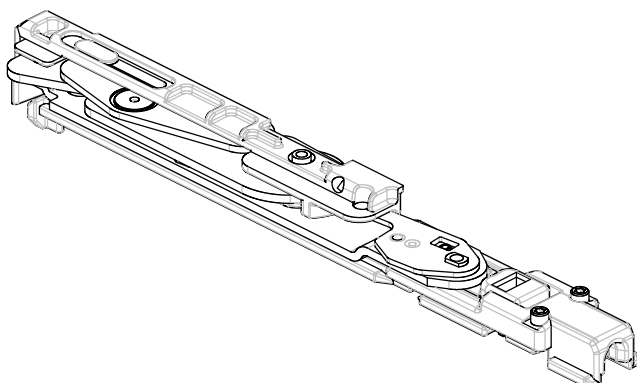

NB

Solo per anta **CX60.260** e **CX60.261**

APPLICAZIONE ACCESSORI

RIBALTA

ACX.08.40

Ween hide 180

kit base anta ribalta con anti falsa manovra sulla
cremonese ante CX60.260 e CX60.261

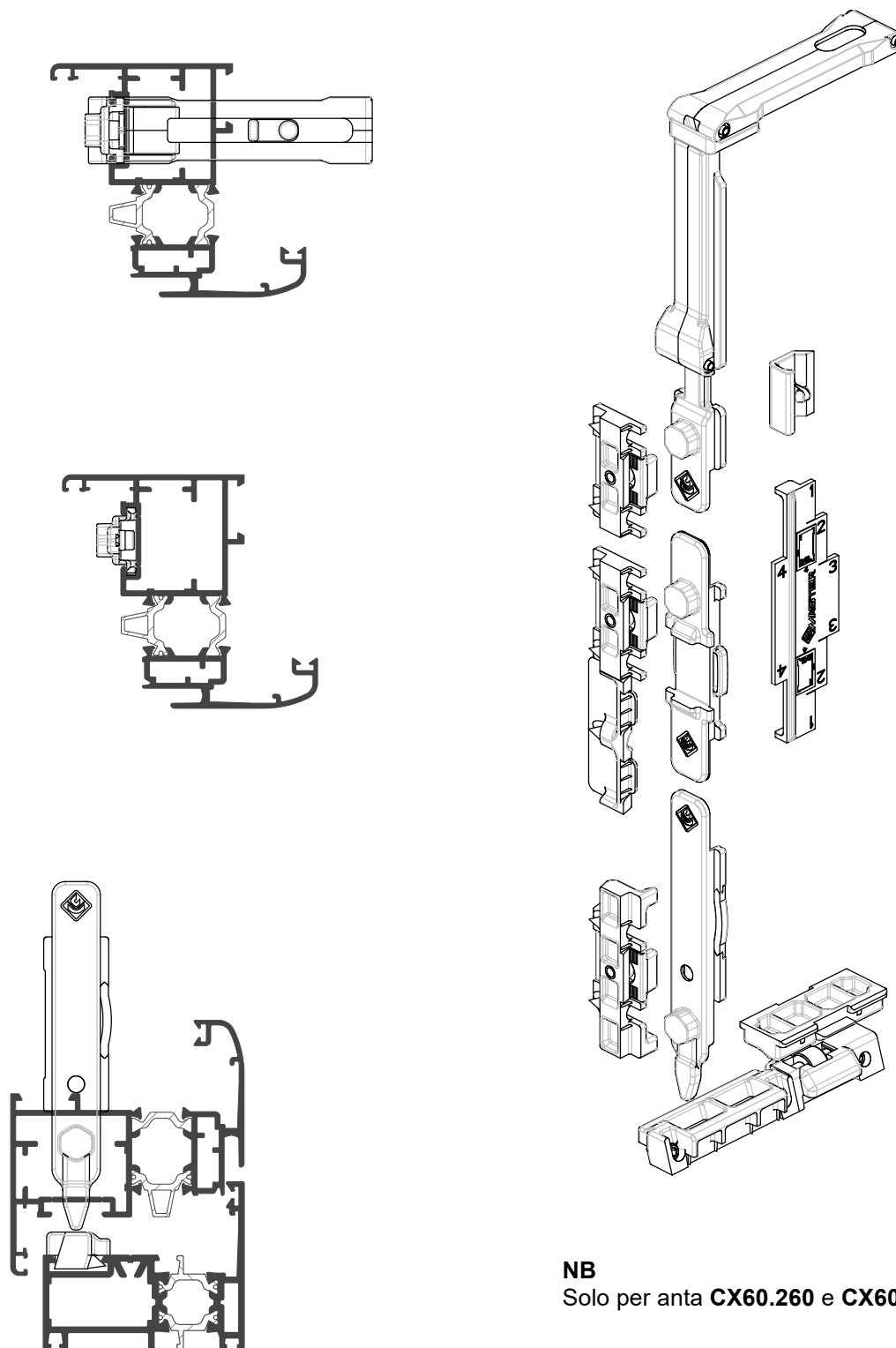

NB
Solo per anta **CX60.260** e **CX60.261**



APPLICAZIONE ACCESSORI

RIBALTA

ACX.08.41

Ween hide 180

kit base anta ribalta con anti falsa manovra sulla cremonese
ante CX60.260 e CX60.261

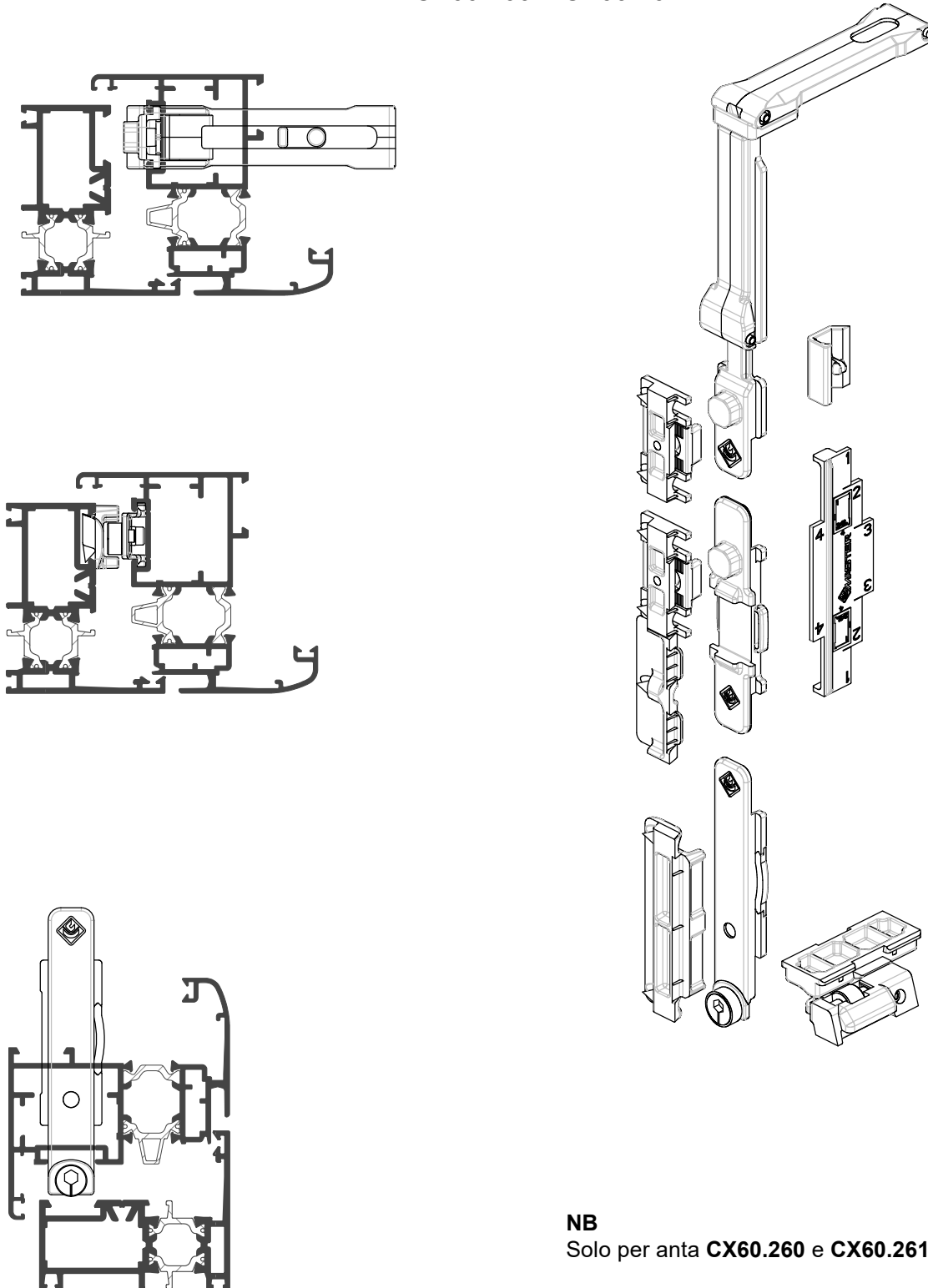

NB

Solo per anta **CX60.260** e **CX60.261**



APPLICAZIONE ACCESSORI

RIBALTA

ACX.08.01

Kit base anta ribalta

Portata massima 160Kg

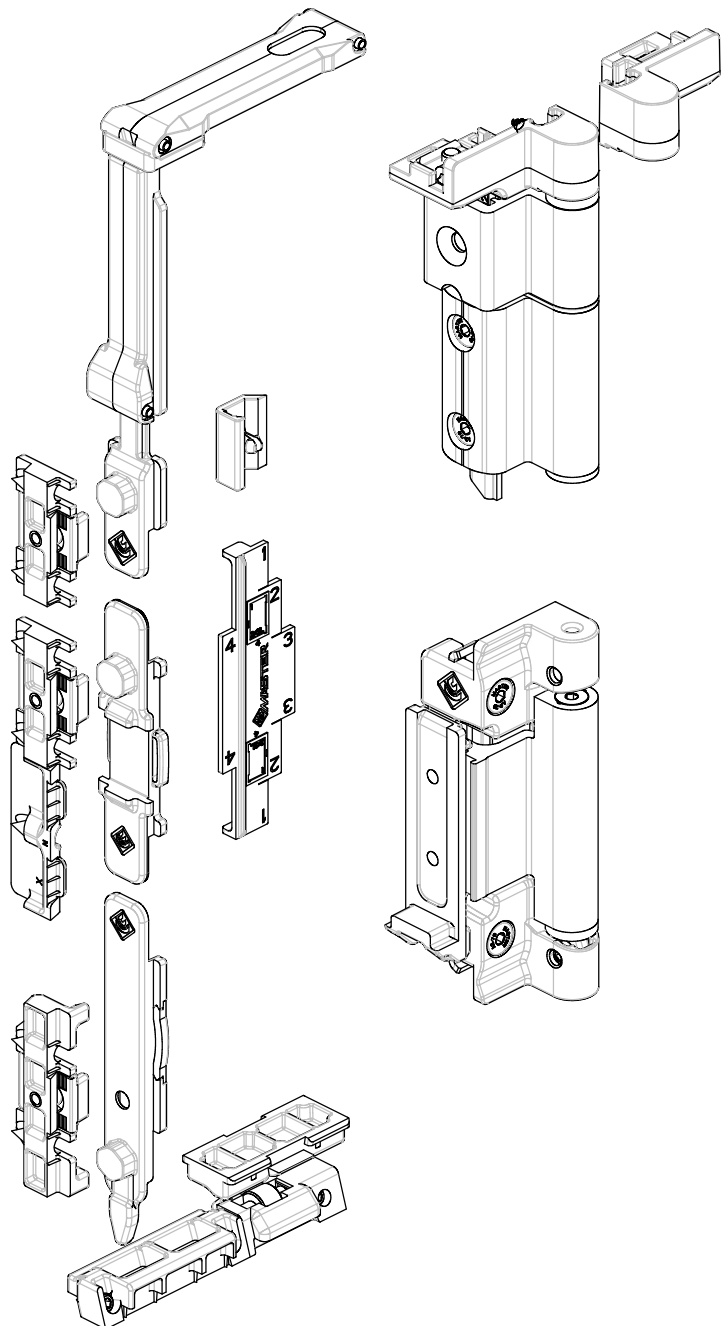
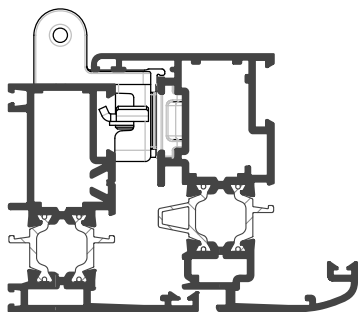
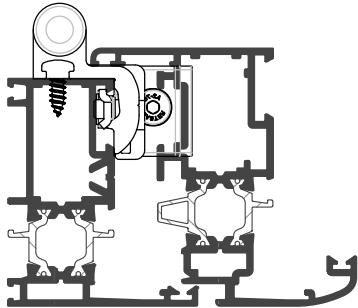

APPLICAZIONE ACCESSORI

RIBALTA

ACX.08.25

Kit cerniere e braccio per anta affiancata

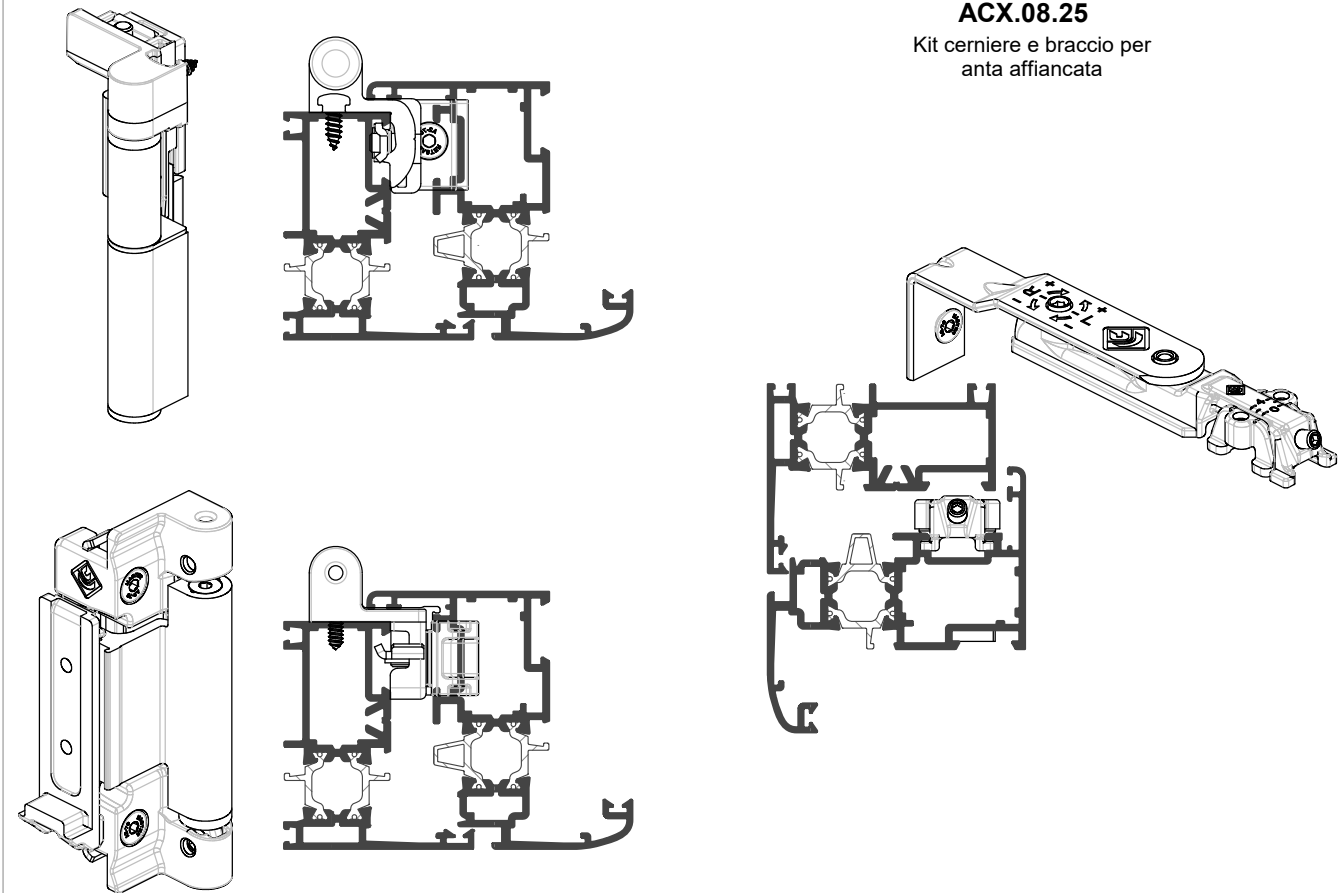

APPLICAZIONE ACCESSORI

ACX.08.24

"WEEN" Braccio lungo per anta ribalta

ACX.08.23

"WEEN" Braccio medio per anta ribalta

ACX.08.22

"WEEN" Braccio corto per anta ribalta

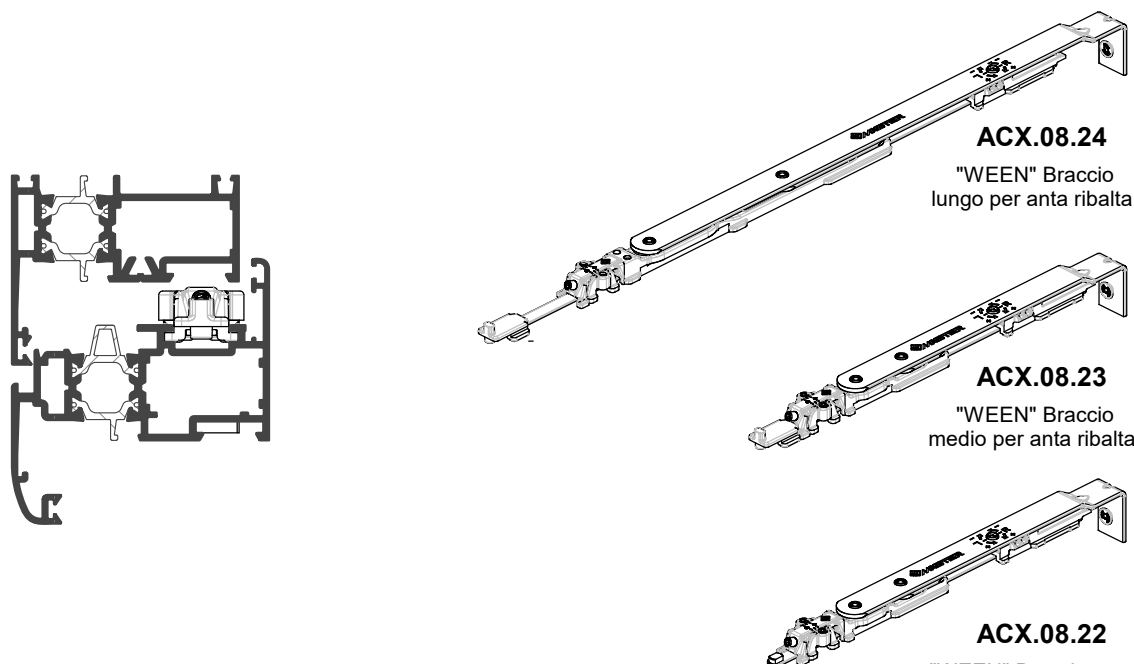



APPLICAZIONE ACCESSORI

RIBALTA

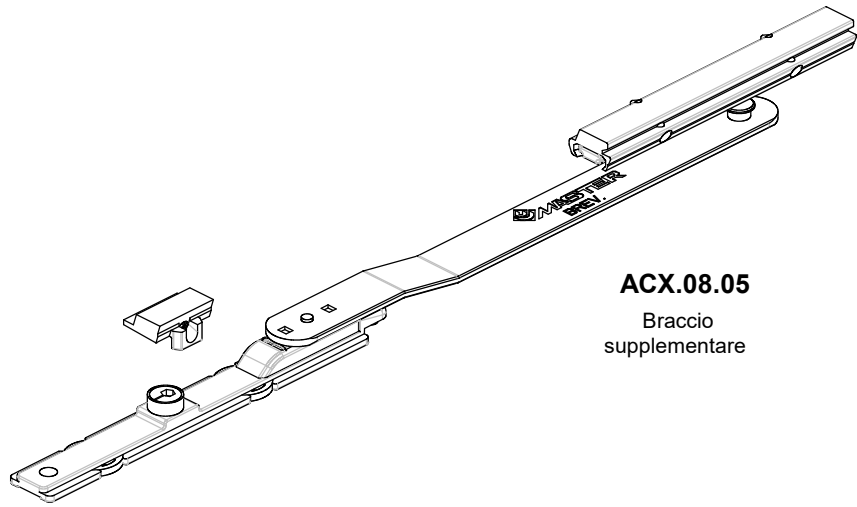
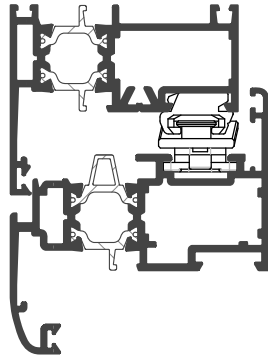

ACX.08.05
Braccio
supplementare

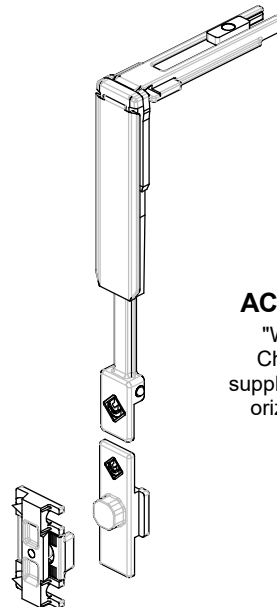
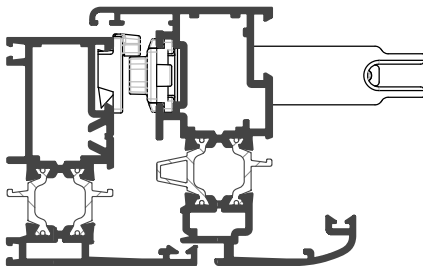

ACX.08.06
"WEEN"
Chiusura
supplementare
orizz./vert.

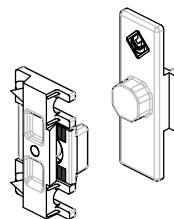
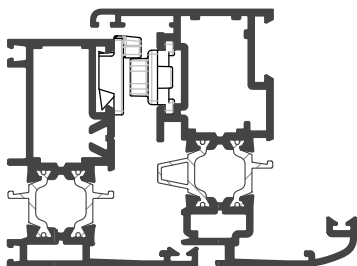

ACX.08.16
"WEEN"
Punto chiusura
supplementare



APPLICAZIONE ACCESSORI

RIBALTA

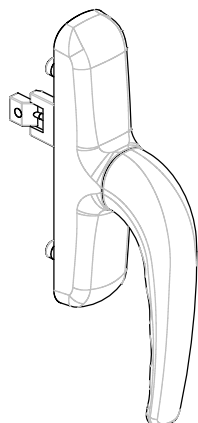

ARX.03.08
Cremonese per anta ribalta

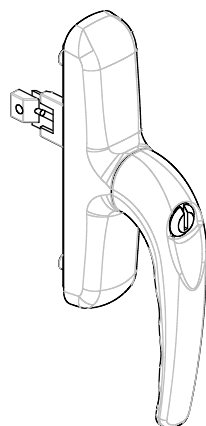
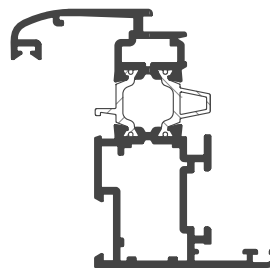
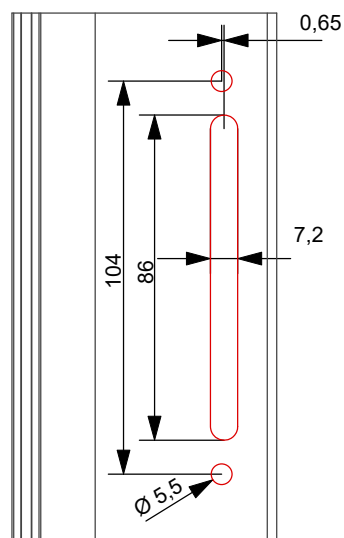
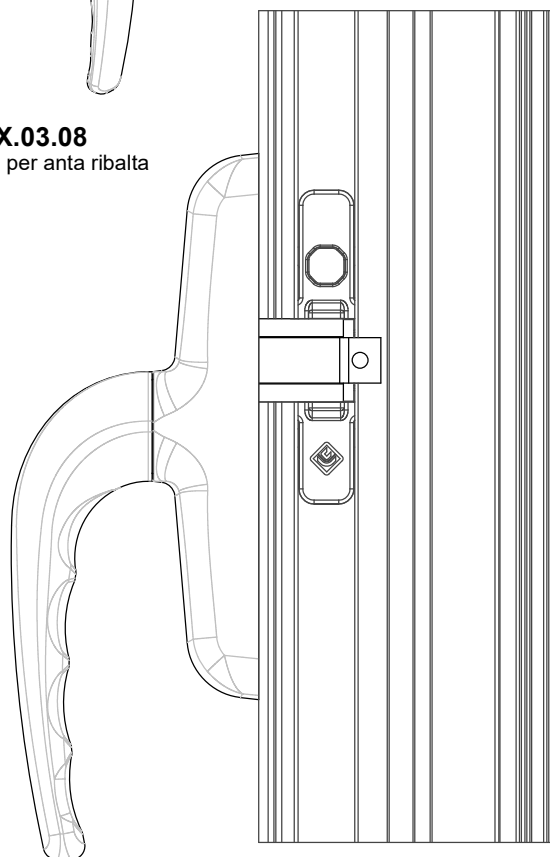

ARX.03.46
Cremonese con chiave per anta ribalta

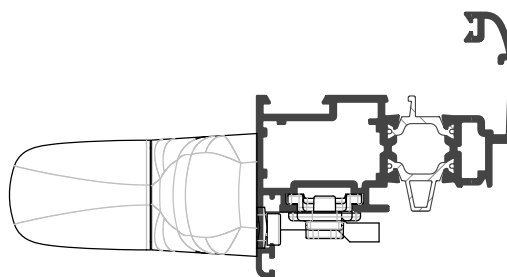

APPLICAZIONE ACCESSORI

SLIM

ACX.03.70

catenaccio a comando diretto SIRIO

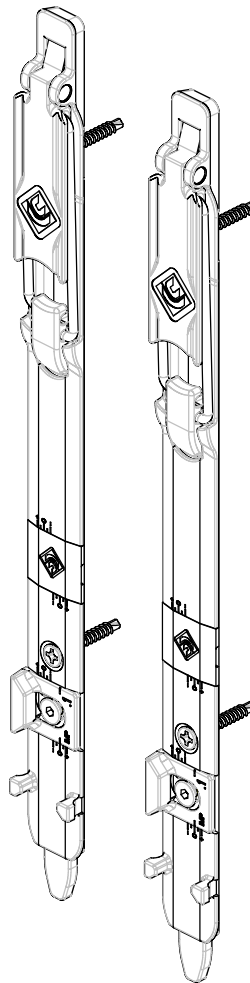
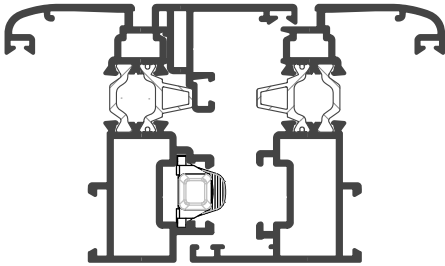
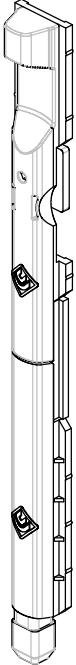

ACX.08.44

Kit catenacci a leva per anta affiancata

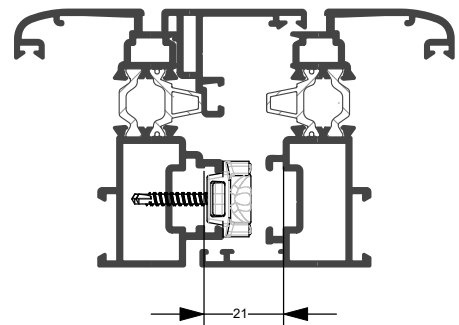

ACX.03.71

Catenaccio a leva "Mini tex"

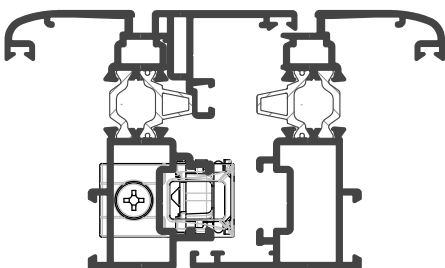
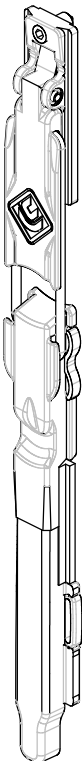



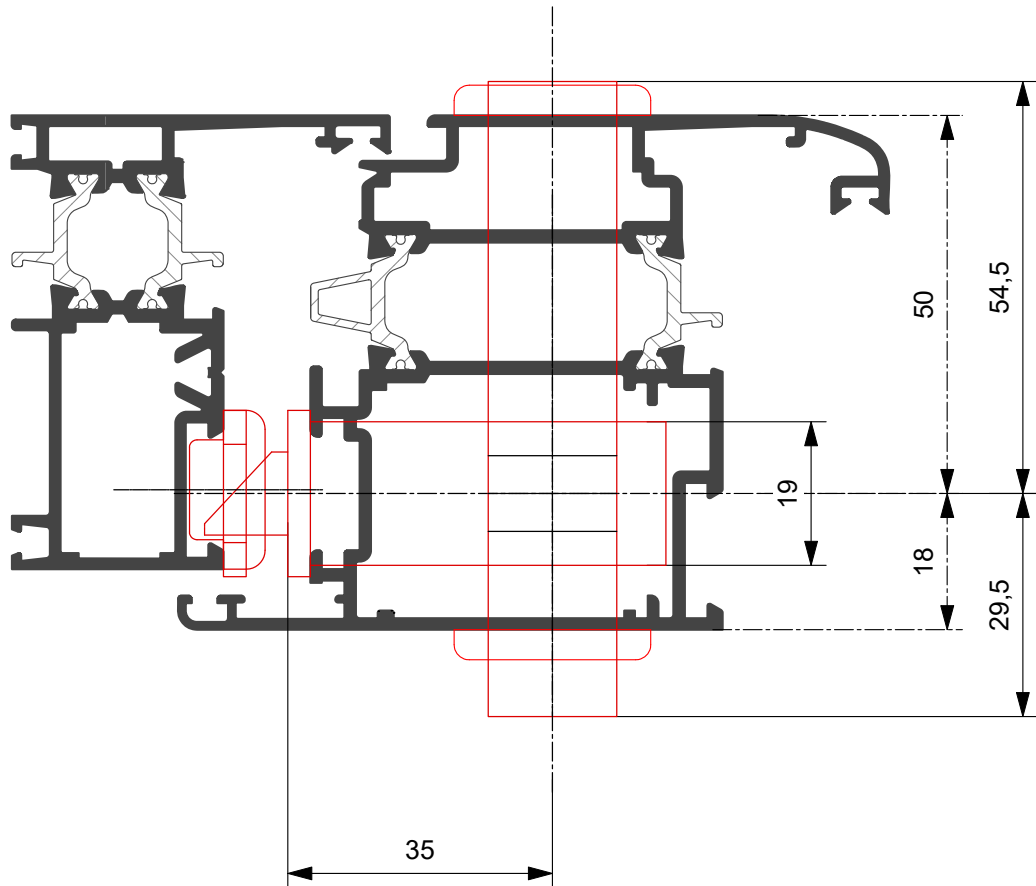

**SERRATURE DI SICUREZZA DA MONTANTE
1 PUNTO DI CHIUSURA**

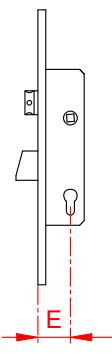

Riferimenti CISA

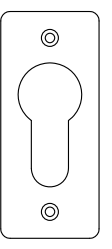
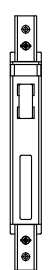



|  | Serratura E= 35 mm | | Contropiastra | | Cilindro | | Borchia |
|-------------------------------------------------------------------------------------|------------------------|-------|-------------------------------------------------------------------------------------|--------------------------------------------------------------------------------------|---------------------------------------------------------------------------------------|---------------------------------------------------------------------------------------|---------------------------------------------------------------------------------------|
| | Tipologia | Art. | Metallo | Registrabile |  |  |  |
| | Catenaccio e scrocco | 46215 |  | 06463 - 22 - 0 per serrature rullo utilizzare inserto 06141.71.0 | Tradizionale | Sicurezza | in dotazione |
| | Catenaccio e rullo | 46230 | | | 0E300. 33.0.12 | 0A3S1. 33.0.12 | |
| | Elettrica con maniglia | 16215 | | | | | |

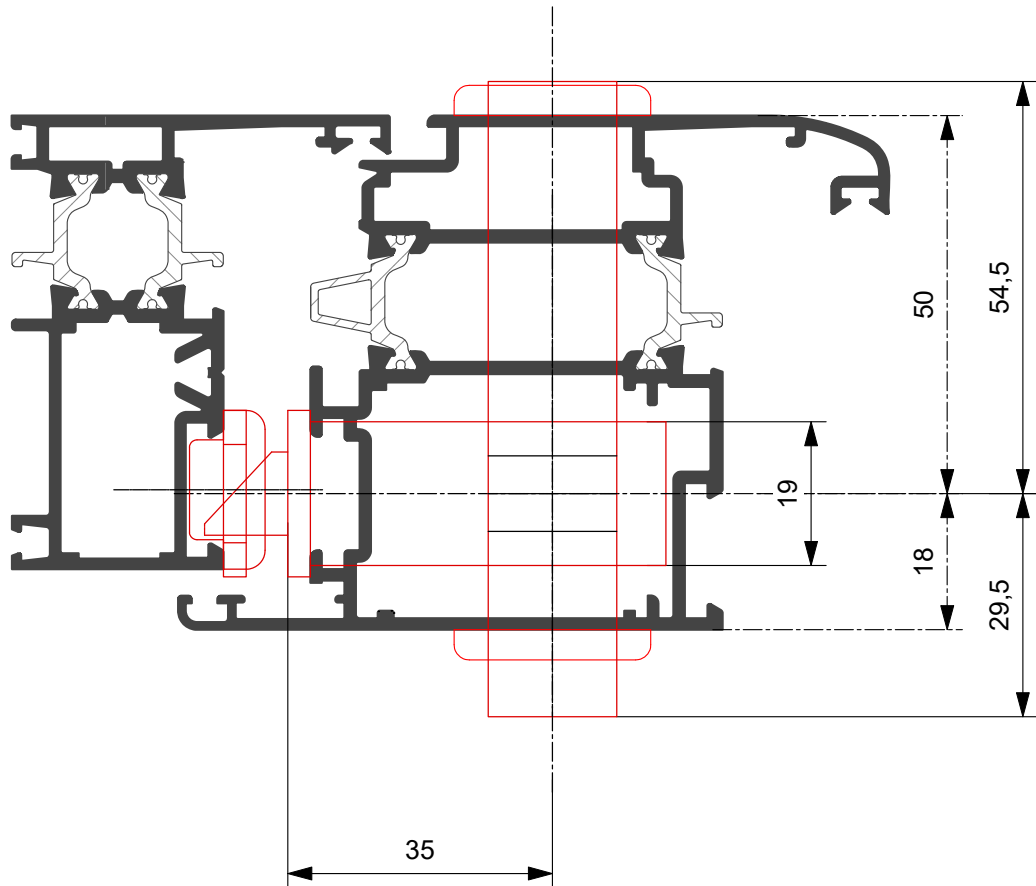

**SERRATURE DI SICUREZZA DA MONTANTE
3 PUNTI DI CHIUSURA**

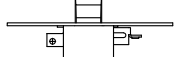

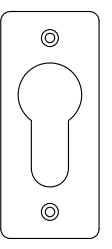
Riferimenti CISA

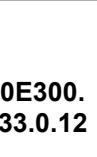
| Serratura E= 35 mm | Contropiastra | | Cilindro | | Borchia | |
|-------------------------------|---------------|------------------------------------------------------------------------------------------------------------------------------------------------------------------------------|------------------------------------------------------------------------------------------------------|-------------------------------------------------------------------------------------------------------------|--------------------------------------------------------------------------------------------------------------------------|-------------------------------------------------------------------------------------------------------|
| | Tipologia | Art. | Metallo | Registrabile | | |
| Catenaccio e scrocco | 48225 |  06463- 32- 0 per serrature rullo utilizzare inserto 06141.71.0 |  06443-21/26-0 |  Tradizionale |  Sicurezza |  in dotazione |
| Catenaccio e rullo | 48250 | | |  06465-42-0 (pz.2) |  0E300. 33.0.12 | |
| Elettrica con maniglia | 18225 | | | | | |



**SERRATURE DI SICUREZZA DA MONTANTE
3 PUNTI DI CHIUSURA - FRONTALE INTERO**

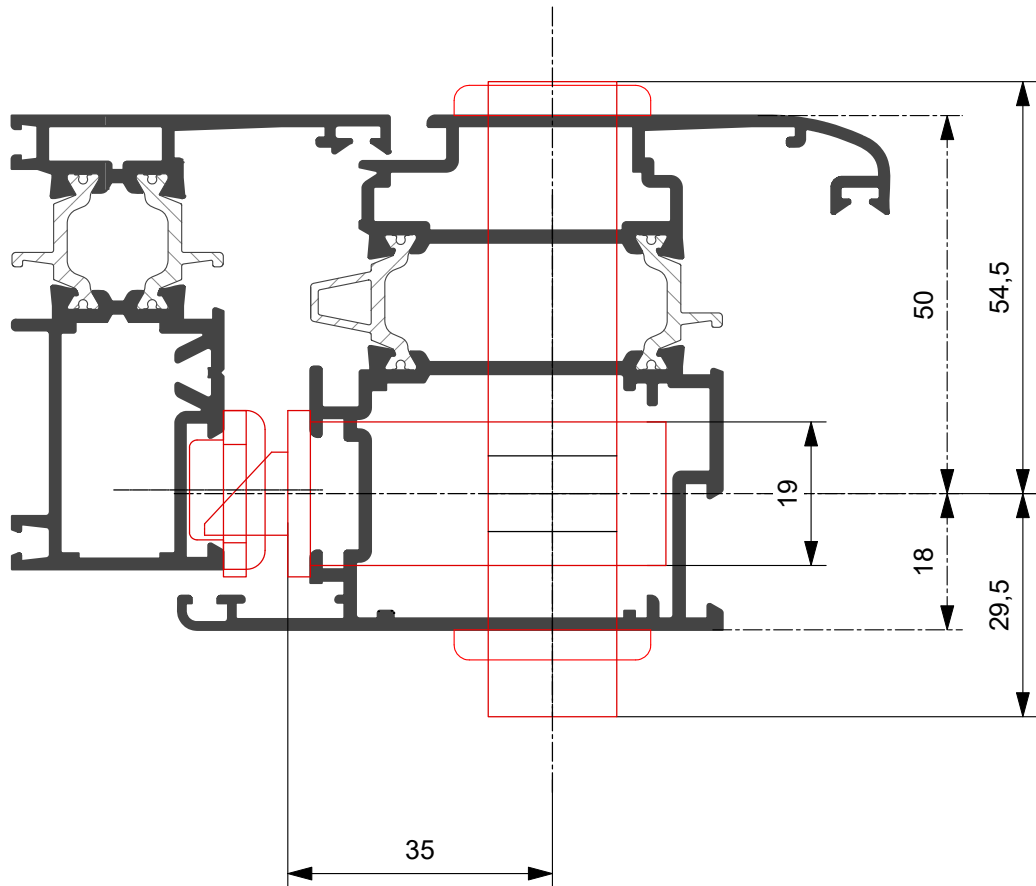

Riferimenti CISA

| Serratura E= 35 mm | Contropiastra | | Cilindro | | Borchia |
|------------------------|---------------|---------------------------------------------------------------------------------------|-----------------------------|---------------------------------|--------------|
| | Tipologia | Art. | Metallo | Registrabile | |
| Catenaccio e scrocco | 48526 | Serratura | Deviatori | Tradizionale | in dotazione |
| Catenaccio e rullo | 48551 | 06463- 32- 0 per serrature rullo utilizzare inserto 06141.71.0 | 06465-42-0 (pz.2) | Sicurezza | |
| Elettrica con maniglia | 18526 | | | 0E300. 33.0.12 | |



**SERRATURE A FASCIA
1 PUNTO DI CHIUSURA**

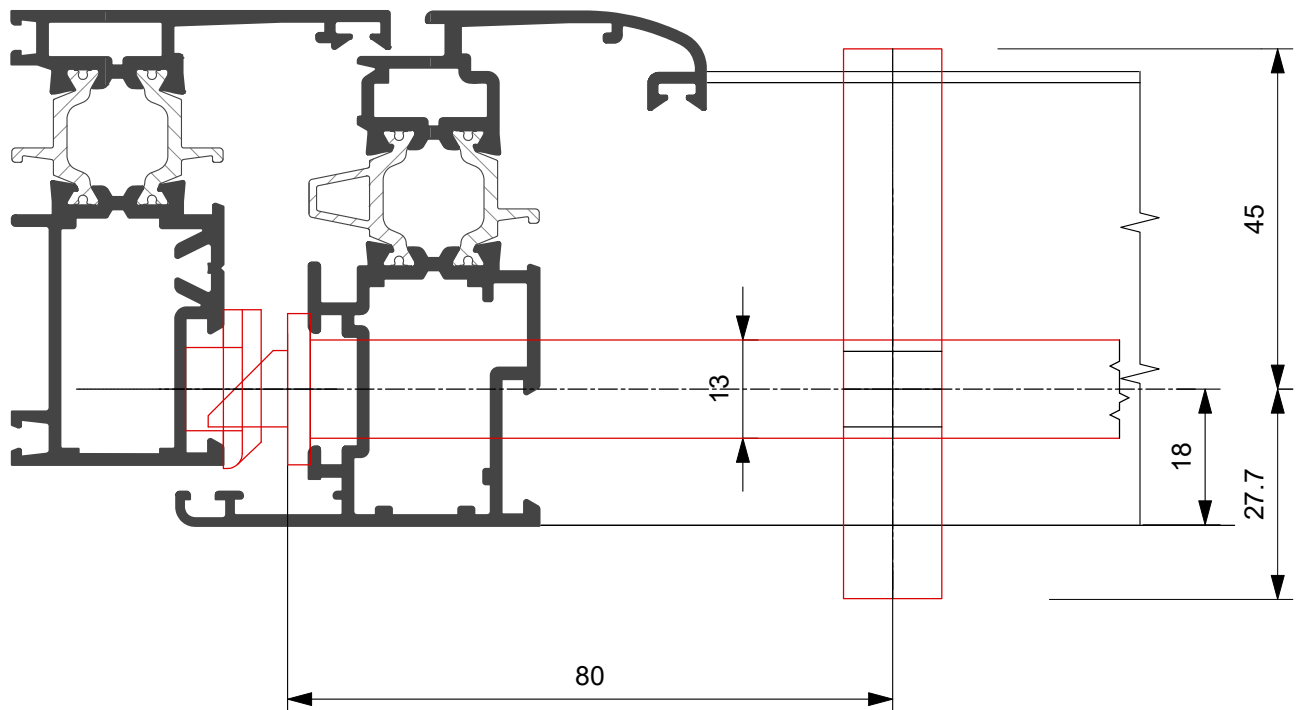

Riferimenti CISA

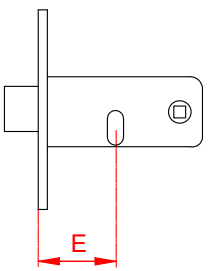
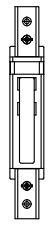
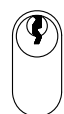
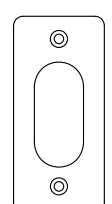



|  | Serratura E= 80 mm | | Contropiastra | | Cilindro | Borchia |
|-------------------------------------------------------------------------------------|--------------------|------------|-------------------------------------------------------------------------------------|-----------------------------------------------------------------------------------------|-------------------------------------------------------------------------------------------------------|---------------------------------------------------------------------------------------|
| | Tipologia | Art | Nylon | Metallo Registrabile | | |
| Catenaccio e scrocco | 44461 44151 | 06277-89-0 |  | 06465 - 21 - 0 per serrature rullo utilizzare inserto 06141.71.0 |  Tradizionale |  |
| Catenaccio e rullo | 44471 | 06277-90-0 | | | | |
| Elettrica con maniglia | 14451 | 06287-89-0 | | | | |

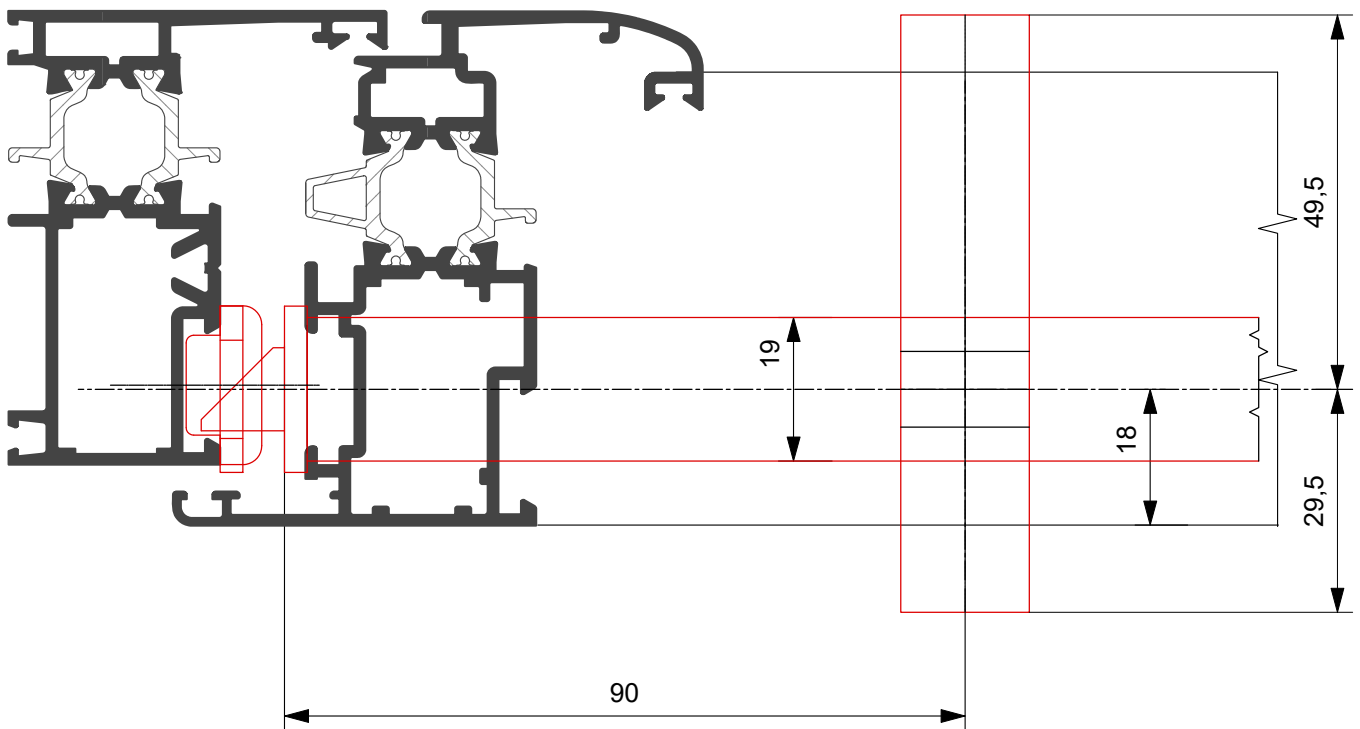

**SERRATURE DI SICUREZZA DA FASCIA A CILINDRO
3 PUNTI DI CHIUSURA**

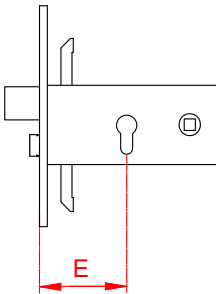

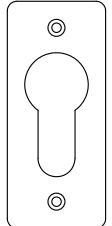
Riferimenti CISA

|  | Serratura doppia mappa E= 90 mm | | Contropiastra | | Cilindro | | Borchia |
|------------------------------------------------------------------------------------|-------------------------------------|-----------------|-------------------------------------------------------------------------------------|----------------------------------------------------------------|---------------------------------------------------------------------------------------|---------------------------------------------------------------------------------------|---------------------------------------------------------------------------------------|
| | Tipologia | Art | Metallo | Registrabile |  |  |  |
| | Catenaccio e scrocco | 56357 |  | 06465 - 22 - 0 | Tradizionale | Sicurezza | in dotazione |
| | Kit rullo | 06168.00 | | per serrature rullo utilizzare inserto 06141.71.0 | 0E300. 17.0.12 | 0A3S1. 17.0.12 | |



**SERRATURE DI SICUREZZA DA FASCIA A DOPPIA MAPPA
3 PUNTI DI CHIUSURA**

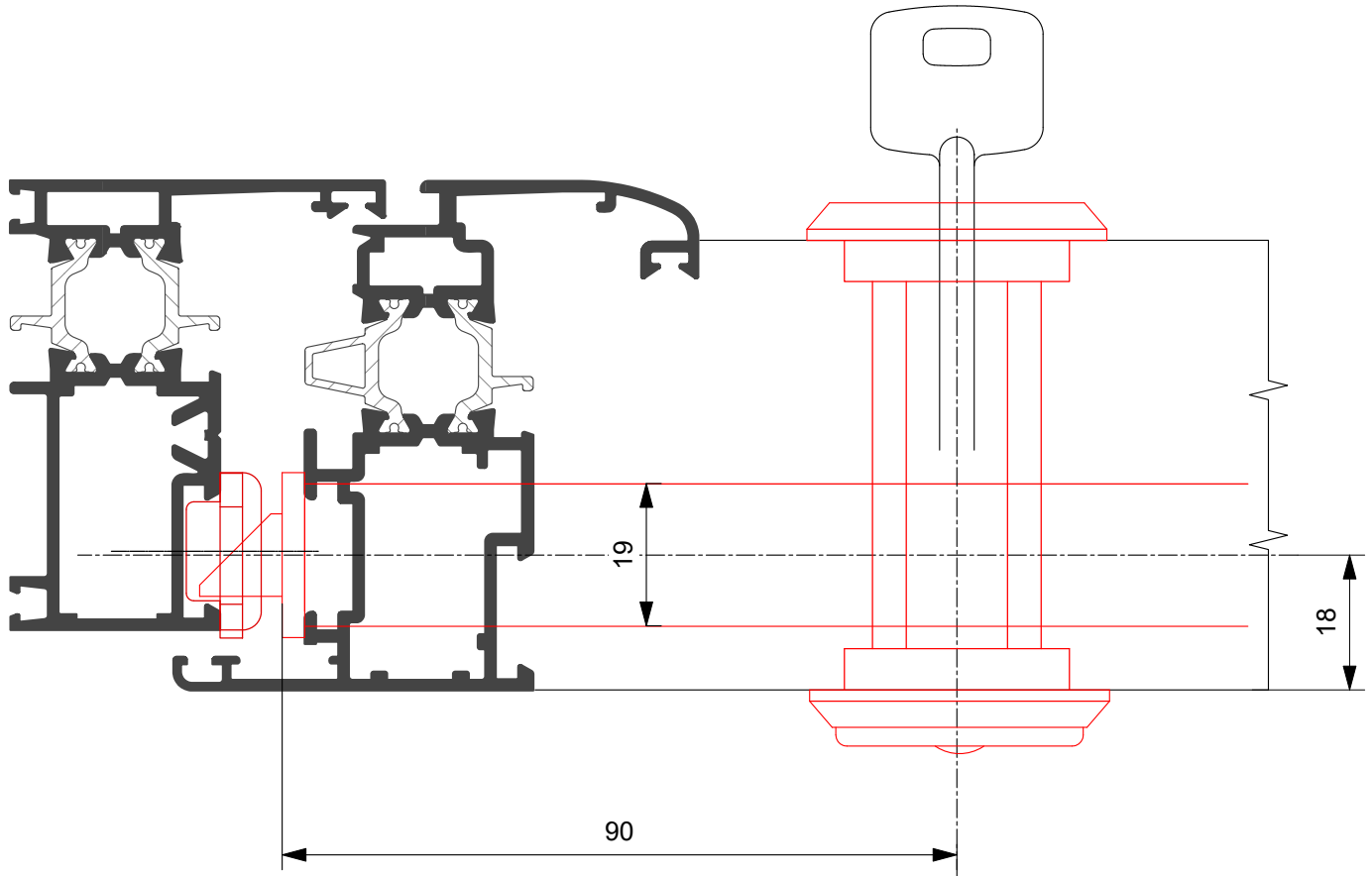

Riferimenti CISA

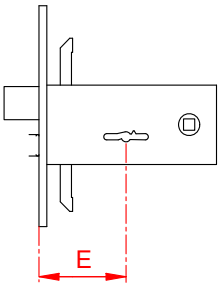
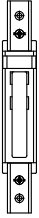
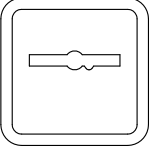

|  | Serratura Doppia Mappa E= 90 mm | | Contropiastra | Borchia |
|------------------------------------------------------------------------------------|---------------------------------|-------------------------------------------------------------------------------------|-----------------------------------------------------------------------------------------|-------------------------------------------------------------------------------------------------------|
| | Tipologia | Art | Metallo Registrabile | |
| Catenaccio e scrocco | 57357-91-0 |  | 06465 - 22 - 0 per serrature rullo utilizzare inserto 06141.71.0 |  in dotazione |
| Catenaccio e rullo | 57365-91-0 | | | |
| Elettrica con maniglia | 17357-91-0 | | | |

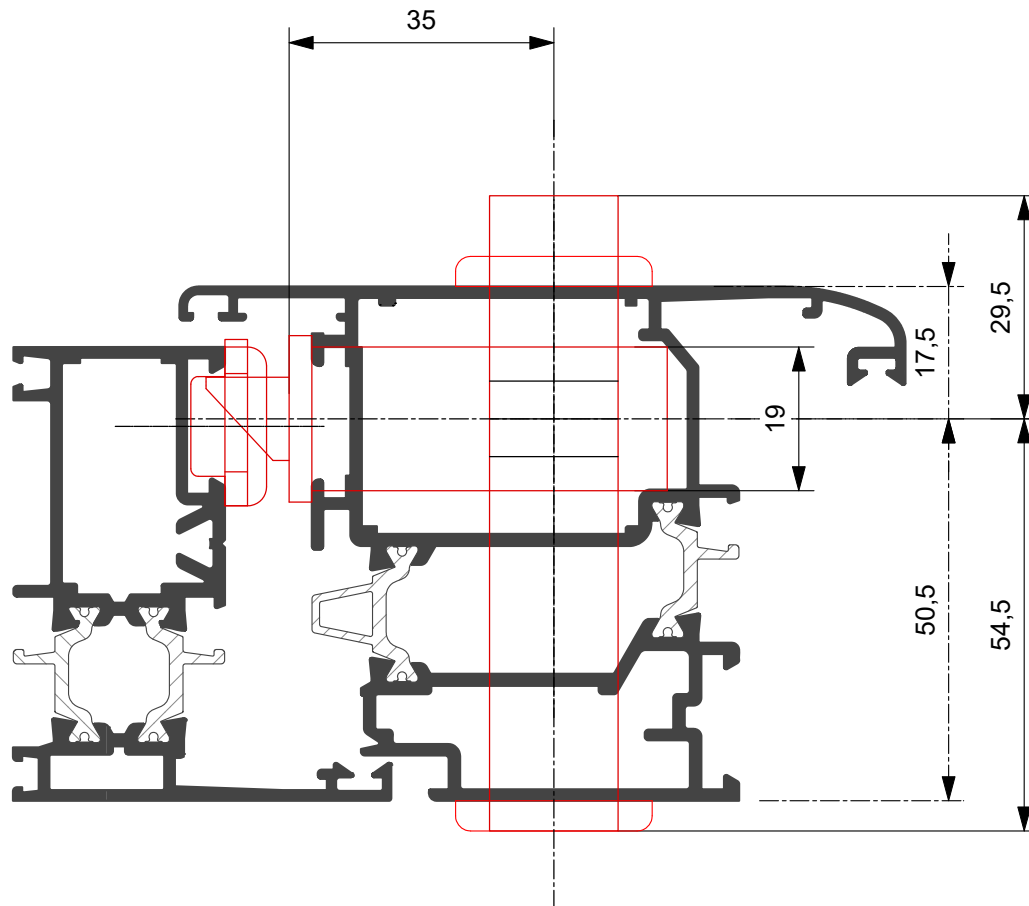

**SERRATURE DI SICUREZZA DA MONTANTE
1 PUNTI DI CHIUSURA**



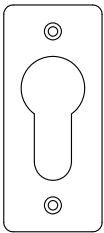

Riferimenti CISA

| Serratura E= 35 mm | Contropiastra | | Cilindro | | Borchia |
|------------------------|---------------|-------------------------------------------------------------------------------------------------------------------------------------------------------------------------|-------------------------------------------------------------------------------------------------------|----------------------------------------------------------------------------------------------------|-------------------------------------------------------------------------------------------------------|
| | Tipologia | Art. | Metallo | Registrabile | |
| Catenaccio e scrocco | 46215 |  06463 - 22- 0 per serrature rullo utilizzare inserto 06141.71.0 |  Tradizionale |  Sicurezza |  in dotazione |
| Catenaccio e rullo | 46230 | | 0E300. 33.0.12 | 0A3S1. 33.0.12 | |
| Elettrica con maniglia | 16215 | | | | |

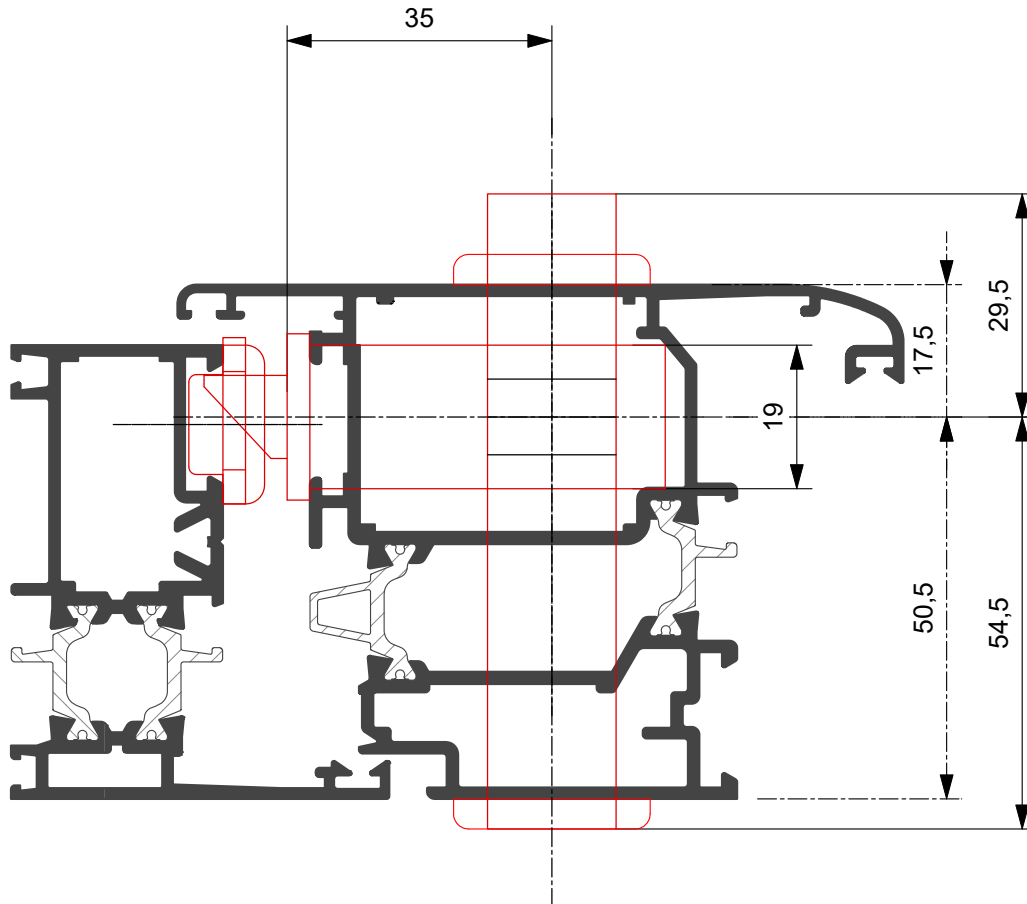
**SERRATURE DI SICUREZZA DA MONTANTE
3 PUNTI DI CHIUSURA - FRONTALE INTERO**

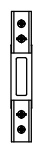

Riferimenti CISA



| Serratura E= 35 mm | Contropiastra | | Cilindro | | Borchia |
|------------------------|---------------|---------------------------------------------------------------------------------------------------------------------------------------------------------------------------|-------------------------------------------------------------------------------------------------------------|--------------------------------------------------------------------------------------------------------------------------|--------------|
| | Tipologia | Art. | Metallo | Registrabile | |
| Catenaccio e scrocco | 48526 | Serratura | Deviatori | Tradizionale | in dotazione |
| Catenaccio e rullo | 48551 |  06463- 32- 0 per serrature rullo utilizzare inserto 06141.71.0 |  06465-42-0 (pz.2) | Sicurezza | |
| Elettrica con maniglia | 18526 | | |  0E300. 33.0.12 | |

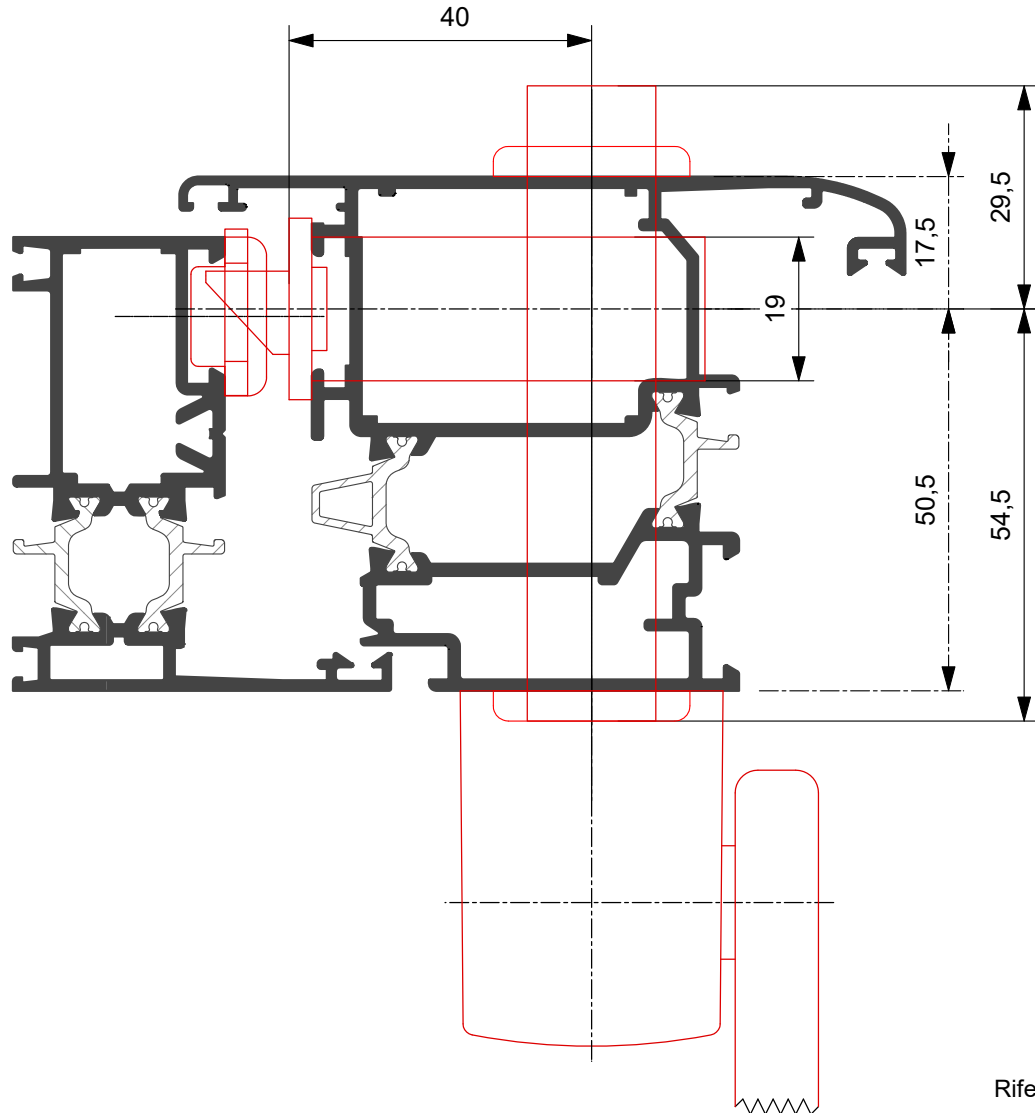

**SERRATURE DI SICUREZZA DA MONTANTE
3 PUNTI DI CHIUSURA - FRONTALE INTERO**

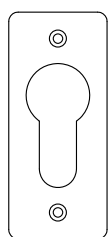
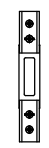
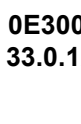
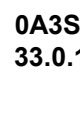

Riferimenti CISA

| Serratura E= 40 mm | Contropiastra | | Cilindro | | Borchia | | |
|-------------------------------|---------------|---------------------------------------------------------------------------------------------------------------------------------------------------------------------|-----------|-------------------------------------------------------------------------------------|----------------------------------------------------------------------------------------------------------------|----------------------------------------------------------------------------------------------------------------|-------------------------------------------------------------------------------------------------------|
| | Tipologia | Art. | Metallo | Registrabile | | | |
| Catenaccio e scrocco Fun. A/D | 43725 |  06463- 32- 0 per serrature rullo utilizzare inserto 06141.71.0 | Serratura | Deviatori |  Tradizionale |  Sicurezza |  in dotazione |
| Catenaccio e scrocco Fun. B | 43735 | | |  |  0E300. 33.0.12 |  0A3S1. 33.0.12 | |
| Maniglione | 59605.06 | | | 06465-22-0 | | | |
| Barra | 07007.61 | | | | | | |

PAM SYSTEM S.r.L.

S.S. 230 - Fornace Crocicchio 13030 Formigliana (VC)
Tel. 0161 858811 - Fax 0121 858800
www.pamsystemsrl.com | info@pamsystemsrl.com

ALQ GENOVA s.r.l.

Direzione & Magazzino

Via Colano, 9/A 12/K 16162 Genova Bolzaneto (GE)
Tel. 010 7491941 - Fax 010 7450155

Magazzino

Via Meucci, 25 Calenzano 50041 (FI)
Tel. +39 055 8825060 Fax: +39 055 8824916
www.alqsystem.it | info@alqgenovasrl.com

PAESANI GROUP

Direzione & Magazzino

Via del Grano, 260 47822 Santarcangelo di Romagna (RN)
Tel. 0541 748511

www.paesani.com | info@paesani.com

Magazzino Nord

Via Luigi Bonati, 21 29017 Fiorenzuola d'Arda (PC)
Tel. 0523 943138
magazzinonord@paesani.com

DIVA s.a.s

Via Po, 25 - Z.I. Sambuceto 66020 S.Giovanni Teatino (CH)
Tel. 085 4405210 - Fax 085 4405207

www.camel-diva.com | info@camel-diva.com

EUROALL S.r.l.

Strada Comunale della Mola Saracena, 23 00065 Fiano Romano (RM)

Tel. 0765 455228/61 - Fax 0765 455317

www.euroallslrl.it | info@euroallslrl.it

PROFILATI UMBRIA S.r.l.

Via Dei Tigli, 35 - 06083 Bastia Umbra (PG)

Tel. 075 8012385 | 075 8010328 - Fax 075 8012386

info@profilatiumbria.it

TSL ALLUMINIO S.r.l.

Via delle Industrie, 12 00030 San Cesario (Roma)

Tel. 06 2251591 (Ric. Aut.) - Fax 06 2280693

www.tslalluminio.it | info@tsllalluminio.it

ALLCAR SERVICE S.r.l.

Via Acuto, 120 - 00131 Roma

Tel. 06 4130626 (Ric. Aut.) - Fax 06.4130367

www.allcarservice.it | allcarservice@mclink.it

ALLUCOM S.r.l.

Andria

Via Vecchia Barletta 237 Z. Ind. - 76123 Andria (BT)

Tel. 0883 592213 - Fax 0883 552386

Bari

Via Zippitelli, 28/B - 70123 (BA)

Tel. 0805058608 - Fax 0805058607

www.allucom.com | info@allucom.com

CARUSO S.r.l.

Z.I. Contrada Le Macere 86019 Vinchiatturo (CB)

Tel. 0874 340024 - Fax 0874340025

carusosrl1@libero.it

CAIMAR S.n.c.

Direzione & Magazzino

Strada Prov.le Rimedio-Torregrande Km. 4
09072 Cabras (OR) - Tel. 0783 290118

Filiale

Fronte S.S. 131 Km. 17,450 - 09023 Monastir (CA)

Tel. 070 9166020 - Fax 070 9166191

www.caimar.it | caimarmail@caimar.it

SALENTO METALLI S.r.l.

Via Federico II, 13 - Zona PIP - 73020 Cavallino (LE)

Tel. 0832 614576 - Fax 0832 614635

www.salentometalli.it | info@salentometalli.it

MIDA ALLUMINIO S.r.l.

Napoli

Via Piano del Principe, 36

80047 San Giuseppe Vesuviano (NA)

Tel. 081 5297373 - Fax 081 8284449

Salerno

Loc. Terzerie, Z.I. - 80061 Ogliastro Cilento (SA)

Tel. 0974 833233 - Fax 0974 844724

www.gruppomida.it | info@gruppomida.it

ITALBACOLOR S.r.l.

C.da Valle S. Maria - 87024 Fuscaldo (CS)

Tel. 0982 618025 - Fax 0982 720235

www.italbacolor.it | commerciale@italbacolor.it

COMAS S.r.l.

Via Porta Palermo, 84 - 91011 Alcamo (TP)

Tel. 0924 507050 - Fax 0924 507051

www.comasgroup.it | info@comasgroup.it

ALUK TIM

Aluk Tim D.o.o.

Žegoti 10, 51215 Kastav Croazia, UE

Tel: +385 (0) 51/691 461 - Fax: +385 (0) 51/691 473

Filiale di Zagabria

Franje Lučića, 34A Zagabria Croazia, UE

Tel: +385 (0) 1 6462 611 - Fax: +385 (0) 1 6462 610

Mob: +385 (0) 99 2939656

zagreb@aluk.hr

Filiale Spalato

Street Sv. Nikole Tavelića, 13A 21204

Dugopolje Croazia, UE

Tel: +385 (0) 21225525

Fax: +385 (0) 21660110

Mob: +385 (0) 99 2199228

split@aluk.hr



  www.twinsystems.it
info@twinsystems.it

Consorzio TWIN SYSTEMS

Via delle Macere, 20 | 00060 Formello [Roma]

Tel./Fax 06 23260298