

CX550

FINESTRE A BATTENTE A TAGLIO TERMICO
CASEMENT WINDOWS W/THERMAL BREAK



TWIN
SYSTEMS

ARCHITETTURE IN ALLUMINIO



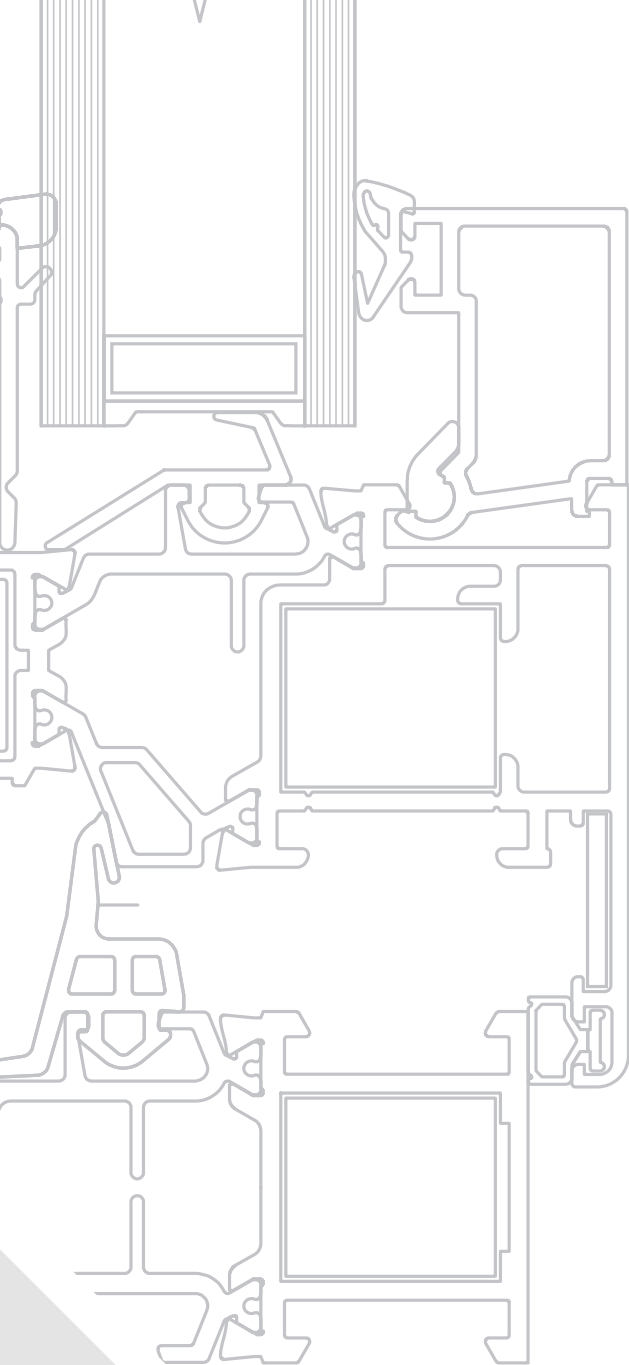

CX550

FINESTRE A BATTENTE A TAGLIO TERMICO
CASEMENT WINDOWS W/THERMAL BREAK





TWIN SYSTEMS

ARCHITETTURE IN ALLUMINIO



Gruppo A
Informazioni Generali
Informazioni Generali

Indice Generale
Caratteristiche Alluminio
Descrizione Tecnica sistema
Descrizione Tecnica Capitolato
Collaudi Prestazionali

Table of Contents
Aluminium Characteristics
Technical Description
Technical Specifications
Performance Tests

Gruppo B
Profili
Profiles

Elenco Profili
Profili Scala 1:1

Profiles List
Profiles Scale 1:1

Gruppo C
Accessori e Guarnizioni
Accessories and Gaskets

Elenco accessori
Elenco guarnizioni

List of Accessories
List of Window Gaskets

Gruppo D
Nodi
Main Sections

Sezioni principali
e Accessori
Sc. 1:1

Main Sections and
Accessories
Scale 1:1

Gruppo E
Tipologie
Types

Tipologie

Types

Gruppo F
Attacco alla Muratura
Wall Joint

Sezione particolareggiata
attacco alla muratura

Wall Joint Detail

Gruppo G
Lavorazioni/Montaggi
Tooling/Assembly

Schemi Lavorazioni
Frese
Attrezzatura

Tooling Systems
Cutters Equipments
Milling

Tutti i dati riportati sul presente catalogo sono indicativi e non impegnativi. La società si riserva il diritto di apportare in qualsiasi momento modifiche atte a migliorare i prodotti. Per informazioni tecniche riguardanti il catalogo contattare l'ufficio tecnico.

All the data shown in this catalog are indicative and not binding. The company reserves the right to make changes to improve the products at any time. For technical information regarding the catalog, contact the technical department.

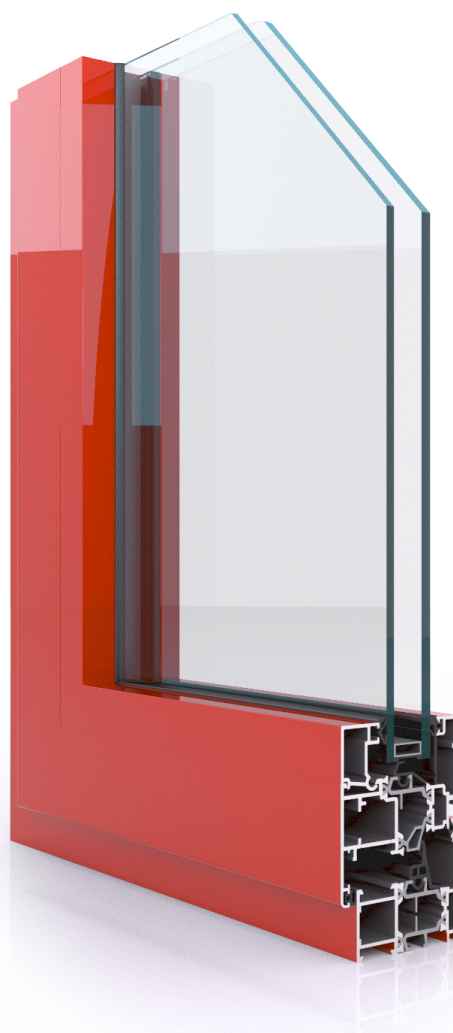

Informazioni Generali
General Information

Gruppo A

Indice Generale	<i>Table of Contents</i>
Caratteristiche Alluminio	<i>Aluminium Characteristics</i>
Descrizione Tecnica sistema	<i>Technical Description</i>
Descrizione Tecnica Capitolato	<i>Technical Specifications</i>
Collaudi Prestazionali	<i>Performance Tests</i>

**PESO PROFILATI**

Il peso indicato è quello teorico e potrà variare in funzione delle tolleranze di spessore e dimensionali dei profilati (NORMA UNI EN 12020-2)

LEGA DI ESTRUSIONE

I profilati sono estrusi in lega EN-AW-6060 (UNI EN 573/3)

DIMENSIONI DEI PROFILATI

Le dimensioni indicate sono quelle teoriche, potranno quindi variare in funzione delle tolleranze dimensionali di estrusione (norma UNI EN 12020-2). Questa variabilità che interessa tutti i profilati, può influire, anche se minimamente, sulle dimensioni di taglio e quindi finali del serramento. Anche la verniciatura, aumentando gli spessori, contribuisce a far variare la dimensione dei profilati e, particolarmente, riduce lo spazio nelle sedi di inserimento delle guarnizioni e degli accessori.

DIMENSIONI DI TAGLIO E LAVORAZIONI

Le dimensioni teoriche di taglio e le quote delle lavorazioni indicate nel presente catalogo sono esatte, ovvero matematicamente corrette, in certi casi dovranno, nella pratica, essere adattate in base alla precisione ed al tipo di impostazione delle misure delle macchine utilizzate. È pertanto consigliabile nei primi lavori o nel caso di importanti quantità di serramenti effettuare delle campionature di prova.

PROTEZIONE SUPERFICIALE

Al fine di limitare i processi di corrosione filiforme è importante applicare le seguenti regole:

- ◆ **Utilizzare accessori di assemblaggio in alluminio**
- ◆ **Utilizzare viti in acciaio inox**
- ◆ **Proteggere le parti tagliate e lavorate con prodotti idonei**
- ◆ **Evitare ristagni di condense all'interno dei profilati.**

Per la realizzazione di serramenti è necessario attenersi alla tecnologia costruttiva e utilizzare le guarnizioni e gli accessori originali riportati sul catalogo tecnico e al rispetto delle norme, prescrizioni e raccomandazioni vigenti. L'osservanza di quanto sopra determina la garanzia.

Su queste basi sono stati realizzati campioni che, collaudati in laboratorio hanno ottenuto i risultati indicati nelle certificazioni. Per il buon funzionamento e la durata degli infissi realizzati con profilati ed accessori del sistema, è necessario effettuare alcune semplici operazioni: una buona pulizia, eliminando residui di calce, cemento e/o altro.

È consigliabile peraltro proteggere il manufatto sino al momento della messa in esercizio, lubrificare con olio o grasso neutri le parti in movimento e gli organi di chiusura, controllare il corretto serraggio delle viti e dei grani, controllare gli assetti, registrandoli laddove sono previste regolazioni. Si raccomanda di effettuare queste operazioni almeno con cadenza semestrale. In caso di funzionamento anomalo di qualche componente, evitare assolutamente interventi atti a modificarne le caratteristiche e la sostituzione con ricambi non originali. Ci sembra utile ricordare che interventi di regolazione e/o sostituzione, con particolare riferimento ai meccanismi per oscillo-battente, andranno eseguiti da personale specializzato. Si raccomanda inoltre, in occasione delle operazioni di pulizia, di non utilizzare detersivi che possano deteriorare i trattamenti superficiali, escludendo tassativamente acidi, solventi, materiali abrasivi, spazzole metalliche o comunque in grado di scalfire le superfici, pagliette metalliche e altro.

WEIGHT OF PROFILES

The weight indicated is the theoretical one and may vary depending on the thickness and dimensional tolerances of the profiles (STANDARD UNI EN 12020-2)

EXTRUSION ALLOY

The profiles are made of extrusion alloy EN-AW-6060 (UNI EN 573/3)

DIMENSIONS OF PROFILES

The dimensions indicated are the theoretical ones; they may vary depending on the extrusion dimensional tolerances (STANDARD UNI EN 12020-2). This variability, which affects all the profiles, can affect, even if minimally, the cutting size and, therefore, the final size of the window. Also the coating, increasing the thickness, affects the size of the profiles and, in particular, reduces the space in the housing of window gaskets and accessories.

CUTTING AND TOOLING DIMENSIONS

The theoretical cutting and tooling sizes indicated in this catalogue are accurate, that is, they are mathematically correct. In practice, in some cases they may need to be adapted to take into consideration the precision and dimensional settings of the machines used. We therefore recommend that test samples be made in the first jobs or in the case of large quantities of windows.

SURFACE PROTECTION

The rules below should be followed to limit filiform corrosion phenomena:

- ◆ **Use aluminium assembly accessories**
 - ◆ **Use stainless steel screws**
 - ◆ **Use appropriate products to protect cut and tooled parts.**
 - ◆ **Prevent condensation from accumulating inside the profiles.**
- When making the windows, comply with the construction technology, use original window gaskets and accessories as listed in the technical catalogue and comply with applicable standards, provisions and recommendations. Non-compliance with the above rules invalidates the warranty. Samples have been made on these bases that, tested in the laboratory, have obtained the results indicated in the certifications. Some simple actions are necessary for the proper functioning and durability of window frames made with the system's profiles and accessories: good cleaning, eliminating traces of lime, cement, etc.
- The product should be protected until the time of installation, lubricate moving parts and closing devices with neutral oil or grease, check that the screws and grub screws are tightened, check the trims, adjusting them where necessary. These operations should be carried out at least once every six months. Should any component not function correctly, do nothing to modify its characteristics and do not use non-original spare parts. Remember that adjustments and/or replacements, with special reference to tilt&turn mechanisms, must be carried out by specialized personnel.
- During cleaning operations, detergents that can damage surface treatments - e.g. acids, solvents, abrasive materials, metal brushes or in any case able to scratch the surfaces, steel wool, etc. - should not be used.



DIMENSIONI E TIPOLOGIA DEI SERRAMENTI

La valutazione delle dimensioni dei serramenti, richiede la considerazione di vari fattori quali: il momento d'inerzia dei profilati, le dimensioni e il peso dei tamponamenti (vetri-pannelli), la larghezza e l'altezza delle parti apribili, caratteristiche e portate degli accessori, le condizioni e le quantità degli ancoraggi alle opere morte, l'esposizione, ecc... Fattori che sono valutabili e applicabili, grazie alla buona conoscenza dello stato dell'arte, alle informazioni riportate dai cataloghi, manuali tecnici e dalle normative vigenti. Consigliamo, al fine di evitare inutili contestazioni, di consultare il nostro servizio tecnico sistemi, prima di realizzare serramenti che, per dimensione, forma, esposizione e/o altro possono essere ritenuti atipici. Le soluzioni e le combinazioni proposte in questo catalogo, non hanno carattere limitativo, ma presentano solo le situazioni e combinazioni più comunemente riscontrabili nella realtà. Soluzioni e combinazioni diverse, così come l'adozione di componentistica particolare, ad esempio meccanismi per la realizzazione di ante scorrevoli parallele, ante scorrevoli a libro o altro, sono possibili. A questo proposito il nostro servizio tecnico prodotti per l'edilizia può valutare e proporre le soluzioni più idonee.

DIMENSIONS AND TYPE OF WINDOWS

Various factors must be taken into consideration when assessing the dimensions of the windows, such as: the moment of inertia of the profiles, the dimensions and weight of the panels (glass-panels), the width and height of the opening parts, the characteristics of the accessories, the condition and number of fastenings to the dead work, the exposure, etc. These factors can be assessed and applied, thanks to the good knowledge of the state of the art and to the information reported in catalogues, technical manuals and current regulations.

In order to avoid needless complaints, we invite you to contact our technical service before making windows that, due to their size, shape, exposure and/or other characteristic, could be considered non-standard. The solutions and combinations proposed in this catalogue are not the only ones available, but merely represent the most common situations and combinations. Different solutions and combinations, as well as the use of particular components, for example mechanisms for parallel sliding doors, folding sliding doors etc., are available. In this regard, our building products technical service can study and propose the most suitable solutions.



COMPOSIZIONE PROFILATI

I profilati per serramenti saranno in lega di alluminio ENAW 6060 (EN 573-3 e EN 755-2) con stato fisico di fornitura UNI EN 515. I telai fissi e le ante mobili dovranno essere realizzati con profilati ad interruzione di ponte termico a tre camere (profilo interno ed esterno tubolari, collegati tra di loro con barrette inb poliammide PA6.6 rinforzate con fibra di vetro).

INFISSI

Le finestre e le porte finestre dovranno avere un profilato di telaio fisso con profondità minima 55 mm. ed un profilato di anta mobile con profondità minima 63 mm. I profilati di telaio fisso dovranno prevedere, dove necessario, alette incorporate di battuta interna sulla muratura da 22 mm.

I profilati di ante mobili dovranno avere un'aletta esterna di battuta per vetro con altezza di 22 mm ed una aletta di battuta interna sul telaio fisso con sormonto di 4 mm. La barretta in poliammide del profilato anta a contatto con la guarnizione di tenuta centrale (giunto aperto), dovrà essere di forma tubolare.

ISOLAMENTO TERMICO

L'interruzione del ponte termico sarà ottenuta da barrette continue in poliammide da 18-26 mm totale e dovrà garantire un valore di trasmittanza termica per l'infisso $U_w = \dots\dots\dots W/m^2K$. L'assemblaggio dei profilati in alluminio a taglio termico dovrà garantire i valori di scorrimento (T) tra profilati in alluminio e barrette in POLIAMMIDE previsti dalla direttiva tecnica Europea (UEAtc).

DRENAGGI E VENTILAZIONE

I profilati esterni delle ante mobili dovranno prevedere una gola ribassata per la raccolta delle acque di infiltrazione e di condensa onde poter permettere il libero deflusso delle stesse attraverso apposite asole di scarico. Le barrette in poliammide dovranno avere una conformazione geometrica atta ad evitare eventuale ristagno di acque di infiltrazione e di condensa ed essere perfettamente complanari con le pareti trasversali dei profilati di alluminio.

ACCESSORI DI ASSEMBLAGGIO

Le giunzioni tra profilati orizzontali e verticali dovranno essere perfettamente solidali e ben allineate tra di loro, sia nella parte esterna che interna dei profilati ed unite mediante apposite squadrette a bottone o, in alternativa, in alluminio estruso o pressofuso, con metodo a spino-cianfrinatura od a cianfrinatura totale. Le sezioni dei profilati orizzontali e verticali dovranno essere opportunamente sigillate prima di essere unite con le squadrette. I fermavetri saranno accoppiati a scatto e posizionati nei canali dei profilati in alluminio.

GUARNIZIONI

Tutte le guarnizioni: cingivetro, di tenuta, di battuta.... dovranno essere in elastomero (EPDM). In particolare la guarnizione di tenuta centrale (giunto aperto) dovrà assicurare la continuità perimetrale mediante l'impiego di angoli vulcanizzati preformati incollati alla stessa o in alternativa mediante telai vulcanizzati.

PRESTAZIONI

I serramenti dovranno avere prestazioni di permeabilità all'aria, tenuta all'acqua e resistenza ai carichi del vento conformemente alle norme:
(UNI-EN 12207 - 12208 - 12210 e UNI-EN 1026 - 1027 - 12211)

PROFILE COMPOSITION

The window profiles are made of ENAW 6060 aluminum alloy (EN 573-3 and EN 755-2) with physical state of supply UNI EN 515. The fixed frames and sliding doors must be made with three-chamber thermal break profiles (tubular internal and external profile, connected to each other with glass fibre reinforced polyamide PA6.6 bars).

DOORS AND WINDOWS

The windows and French doors must have a fixed frame profile with a minimum depth of 55 mm and a sliding door profile with a minimum depth of 63 mm. Where necessary, the fixed frame profiles must have an incorporated 22 mm internal stop flap on the brickwork.

The profiles of sliding doors must have an external stop flap for glass with a height of 22 mm and an internal stop flap on the fixed frame with overlap of 4 mm. The polyamide bar of the door profile in contact with the central sealing gasket (open joint), must be tubular.

THERMAL BREAK

The thermal bridge will be interrupted using solid 18-26 mm polyamide bars guarantee a heat transmission value of the frame $U_w = \dots\dots\dots W/m^2K$. The assembly of aluminum profiles with thermal break will guarantee the slide values (T) between the aluminium profiles and polyamide bars set forth in the European Technical Directive (UEAtc).

DRAINAGE AND VENTILATION

The junctions between horizontal and vertical profiles must be perfectly integral and well aligned with each other; both in the external and internal part of the profiles and joined by means of special button brackets or, alternatively, in extruded or die-cast aluminum, with the pin-crimping method or with total crimping. The sections of the horizontal and vertical profiles must be properly sealed before being joined with the brackets. The glazing beads will be snap coupled and positioned in the channels of the aluminum profiles.

ASSEMBLY ACCESSORIES

The joints between the horizontal and vertical profiles must be perfectly united and correctly aligned with each other, both externally and internally and joined by means of special slot corner joints or, alternatively, in extruded or die-cast aluminum, with a dowel-crimping or full crimping method. The sections of the horizontal and vertical profiles must be properly sealed before being joined with the corner joints. The glazing beads will be snap-coupled and positioned in the channels of the aluminum profiles.

WINDOW GASKETS

All window gaskets: glazing, sealing, rabbet.... must be made of elastomer (EPDM). Specifically, the central sealing gasket (open joint) must ensure perimeter continuity using preformed vulcanized corner joints glued to it or, alternatively, vulcanized frames.

PRESTAZIONI

I serramenti dovranno avere prestazioni di permeabilità all'aria, tenuta all'acqua e resistenza ai carichi del vento conformemente alle norme:
(UNI-EN 12207 - 12208 - 12210 e UNI-EN 1026 - 1027 - 12211)

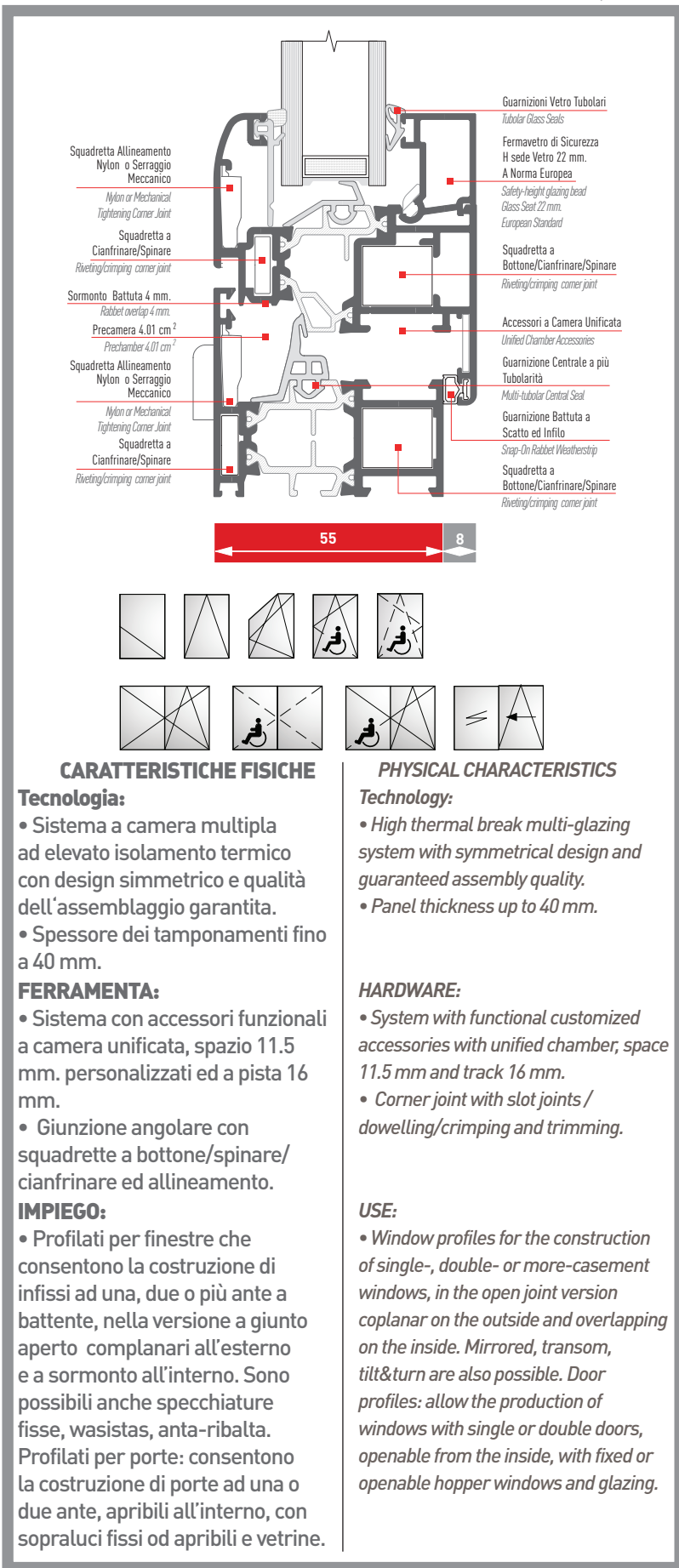

CARATTERISTICHE FISICHE

Tecnologia:

- Sistema a camera multipla ad elevato isolamento termico con design simmetrico e qualità dell'assemblaggio garantita.
- Spessore dei tamponamenti fino a 40 mm.

FERRAMENTA:

- Sistema con accessori funzionali a camera unificata, spazio 11.5 mm. personalizzati ed a pista 16 mm.
- Giunzione angolare con squadrette a bottone/spinare/cianfrinare ed allineamento.

IMPIEGO:

- Profilati per finestre che consentono la costruzione di infissi ad una, due o più ante a battente, nella versione a giunto aperto coplanari all'esterno e a sormonto all'interno. Sono possibili anche specchiature fisse, wasistas, anta-ribalta. Profilati per porte: consentono la costruzione di porte ad una o due ante, apribili all'interno, con sopraluci fissi od apribili e vetrine.

PHYSICAL CHARACTERISTICS

Technology:

- High thermal break multi-glazing system with symmetrical design and guaranteed assembly quality.
- Panel thickness up to 40 mm.

HARDWARE:

- System with functional customized accessories with unified chamber, space 11.5 mm and track 16 mm.
- Corner joint with slot joints/dowelling/crimping and trimming.

USE:

- Window profiles for the construction of single-, double- or more-casement windows, in the open joint version coplanar on the outside and overlapping on the inside. Mirrored, transom, tilt&turn are also possible. Door profiles: allow the production of windows with single or double doors, openable from the inside, with fixed or openable hopper windows and glazing.

CARATTERISTICHE FISICHE | PHYSICAL CHARACTERISTICS

- ♦ Telaio Fisso | Fixed Frame: **55 mm.**
- ♦ Telaio Mobile | Window Frame: **63 mm.**
- ♦ Barrette Isolanti | Insulating Rods: **18 - 26 mm.**
- ♦ Fuga Perimetrale | Perimeter Gap: **5 mm.**
- ♦ Alloggiamento Accessori | Accessories Housing: **Camera Europea dim. 11.5 mm.** [European Chamber]
- ♦ Giunzione Angolare | Corner Joint: **Bottone, Spinare, Cianfrinare** [Dowelling/Crimping and Trimming Riveting Slot]

PRESTAZIONI CERTIFICATE | CERTIFIED PERFORMANCES

AAV

- ♦ Permeabilità all'aria | Air Permeability: **Classe 4**
- ♦ Tenuta all'acqua | Watertightness: **Classe E 1350**
- ♦ Carico di vento | Wind load resistance: **Classe C5**
- ♦ Isolamento acustico | Sound Insulation: **fino a dB**
- ♦ Resistenza all'effrazione | Breakage resistance: **Classe RC 2**

Risultati dei test / CE product pass conforme ad:
Tests Results / CE product pass Compliant with:
UNI EN 14351-1:2006+A1:2010

TRASMITTANZA | TRANSMITTANCE

- 1 ANTA | Single SASH: **U_w = 1.32 W/(m²K)**
- 2 ANTE | Double SASH: **U_w = 1.45 W/(m²K)**

SERRAMENTO CAMPIONE | SAMPLE FRAME

- ♦ Vetro Certificato | Certified Glass: Double Glazing U_g = 1.0 W/(m²K)
- ♦ Canalina | Duct: psi = 0.036 W/(m²K)
- ♦ Finestra normalizzata | Normalized Window: H = 1480 mm. ed L = 1535 mm.

- 1 ANTA | Single SASH: **U_w = 1.00 W/(m²K)**
- 2 ANTE | Double SASH: **U_w = 1.16 W/(m²K)**

SERRAMENTO CAMPIONE | SAMPLE FRAME

- ♦ Vetro Certificato | Certified Glass: Triple Glazing U_g = 0.6 W/(m²K)
- ♦ Canalina | Duct: psi = 0.031 W/(m²K)
- ♦ Finestra normalizzata | Normalized Window: H = 1480 mm. ed L = 1535 mm.

■ **Dimensioni massime ammesse per il calcolo Uw su serramento campione fino a 2.3 m2 (secondo norma UNI EN 14351-1:2006+A1:2010)**

■ **Maximum allowable dimensions for calculation of the Uw on sample window frame up to 2.3 m² (according to UNI EN 14351-1:2006+A1:2010)**

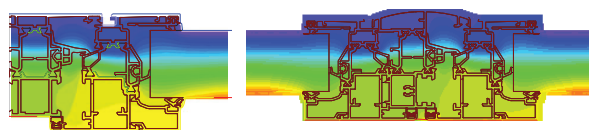

■ **Analisi termica con FLIXO vers.8 e WinIso2D Professional 7.8**
■ **Thermicon FLIXO vers.8 e WinIso2D Professional 7.8**



Agenti Atmosferici | Atmospherics

Tenuta all'Acqua
Watertightness



Capacità di un inso di impedire infiltrazioni quando è investito da un flusso d'acqua ed è presente una differente pressione tra interno ed esterno.
Capacity of a window to prevent infiltrations when impacted by a gush of water and there is a different internal and external pressure.

Press.	0Pa5	0Pa	100Pa	150Pa	200Pa	250Pa	300Pa	450Pa	600Pa	750Pa	900Pa	1050Pa	1200Pa	1350Pa	1500Pa	178
Velocità	03	24	55	56	47	27	89	6	111	126	138	149	159	169	178	
Classe	- 1	A2	A3	A4	A5	A6	A7	A8	A	E750	E900	E1050	E1200	E1350	E1500	178

Classe | Class
1350
EN 1027 - EN 12208

Tenuta all'Aria
Air Permeability



Caratteristica di un inso chiuso di lasciare trarre aria quando è presente una differenza di pressione tra l'interno e l'esterno; minori saranno i volumi dispersi, maggiore sarà la qualità del serramento.
Characteristic of a closed window to let air filter through when there is a different internal and external pressure; the lower the dispersed volumes, the higher the quality of the frame.

Press.	150Pa	300Pa	450Pa	600Pa	Pressure	L'infisso TWIN ha superato la prova con Pressione Vento = 111 k/h (600Pa) The frame TWIN has passed the test with a Wind Pressure = 111 Km/h (600Pa)
Classe	1	2	3	4	Class	

Classe | Class
4
EN 1026 - EN 12207

Resist. al Vento
Wind Resistance



Capacità di un inso sottoposto a forti pressioni e/o depressioni, come quelle causate dal vento, di mantenere una deformazione ammissibile, di conservare le proprietà iniziali a salvaguardia della sicurezza degli utenti.
Capacity of a window subject to high positive and/or negative pressures, like that caused by the wind, to maintain an admissible deformation, to conserve its initial properties and to safeguard users against breakage.

Press.	400Pa	800Pa	1200Pa	1600Pa	2000Pa	>2000Pa	Pressure
Flessione	A (≤ 1/150)	B (≤ 1/200)	C (≤ 1/300)				Flexure
Classe	12	34	5E	xxx			Class

Classe | Class
C5
EN 12211-EN 12210

* Serramento a 2 ante, dimensione L = mm.1495 ed H = mm.1500 - Certificato n° RP/1994/2001 (Altre Certificazioni Disponibili)
Double Casement window, dimension L = mm.1495 ed H = mm.1500 - Test certificate no. RP no. RP/1994/2001 (Other certifications available).

Fonoisolamento
Sound Insulation



Perdita di isolamento acustico rispetto al vetro DR_w (dB) a partire dalla classe di permeabilità all'aria dell'infisso (UNI EN 12207)
Capacity of a window to resist violent intrusion following the application of a physical force or with the aid of tools.

Classe	1	2	3	4	Class	DR _w ≤ 38 dB	Ammesso l'utilizzo di questo metodo tabellare Admitted This table method
Perdita	8dB	6dB	4dB	2dB	Loss	DR _w > 39 dB	Necessario realizzare un campione al vero e sottoporre a prove di Laboratorio. An actual sample must be made and tested in the laboratory.

Abbattimento Acustico
Noise Reduction
dB
EN ISO140-3 | 717-1

Trasmissione
Transmittance

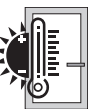

Flusso di calore che passa attraverso il serramento per m2 di superficie e per ogni grado di differenza di temperatura tra interno ed esterno.
Flow of heat that passes through the window per m2 of surface and for every degree of difference in temperature between outdoors and indoors.

U _w	1.45 W/m²K
	Finestra a 2 ante normalizzata (1535 mm. x 1480 mm; vetro doppio U _g = 1.0 W/m²K certificato con canalina psi = 0.036 W/m²K) Normalised 2 Sashes window (1535 mm x 1480 mm; double glazing U _g = 1.0 W/m²K certified with duct psi = 0.036 W/m²K)
U _w	1.16 W/m²K
	Finestra a 2 ante normalizzata (1535 mm. x 1480 mm; vetro triplo U _g = 0.6 W/m²K certificato con canalina psi = 0.031 W/m²K) Normalised 2 Sashes window (1535 mm x 1480 mm; triple glazing U _g = 0.6 W/m²K certified with duct psi = 0.031 W/m²K)

Effrazione | Breakage

Antieffrazione
Breakage Resistance



Capacità di un infisso di resistere ad un'intrusione violenta a seguito di una applicazione di una forza fisica e con l'aiuto di attrezzi Finestra a 2 ante (1230 mm. x 1480 mm) - CERTIFICATO RT/480/2023
Capacity of a window to resist violent intrusion following the application of a physical force or with the aid of tools. 2 sashes window (990 mm x 2145 mm) - CERTIFICATE RT/480/2023

Classe	RC1	RC2	RC3	L'infisso TWIN, resiste in modo efficace ai tentativi di intrusione interna. The TWIN window effectively resists attempted breakins
Intrusione	Forza Fisica (Calci, Pugni, Spallate)	Semplice Attrezzatura (Cunei, Cacciaviti)	R2 + Piede di Porco	
Intrusion	Physical strength (kicks, pushing, pushing with shoulder)	Simple Tools (Wedges, Screwdrivers)	R2 + Crowbar	

Resistenza Effrazione
Breakage Resistance
RC 3

Resistenze Meccaniche | Mechanical Strength

Azionamento
Handling



Classe	0	1	2	Classe	L'infisso TWIN consente grande facilità di apertura con uno sforzo minimo The frame TWIN allows easy opening with minimal effort
Forza				Force	

Classe | Class
1
EN 13115

Forze Applicate
Applied Forces

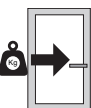

Resistenza di un infisso a carichi applicati senza riportare rotture, deformazioni permanenti o torsioni tali da pregiudicare il suo corretto esercizio
Capacity of a window to resist applied loads without torsion, permanent deformation or breakage undermining its correct functioning.

Classe	1	2	3	4	Classe	L'infisso TWIN resiste ai carichi applicati senza torsioni, deformazioni permanenti o rotture. The frame TWIN is resistant to applied loads without torsion, permanent deformation or breakage.
Carico Verticale	200 N	400 N	600 N	800 N	Vertical Load	
Torsione Statica					Static Torsion	

Classe | Class
4
EN 13115 EN 12046

Cicli di Utilizzo
Cycles of Use

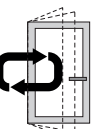

Capacità di un infisso di resistere nel tempo a ripetuti cicli di Apertura e Chiusura | Capacity of a window to resist opening and closing cycles over time.

Grado	3	4	5	Grado	L'infisso TWIN resiste ai cicli di Apertura e Chiusura The TWIN window effectively resists opening and closing cycles.
N° Cicli	10'000 A/C	15'000 A/C	25'000 A/C	N. of Cycles	

Grado | Grade
5
EN 1326 - 4

Urti
Impacts



Capacità di un infisso di resistere in caso di Urti involontari o accidentali | Capacity of a window to resist in the case of involuntary or accidental impacts.

Classe	1	2	3	4	5	Classe	L'infisso TWIN resiste efficacemente agli Urti [Metodo di Prova con "CORPO DURO"] The TWIN effectively resists impacts. ["HEAVY BODY" Test Method]
Altezza Caduta	200mm.	300 mm.	450 mm.	700 mm.	950 mm.	Drop Height	

Classe | Class
1
EN 13115 EN 12046



Battente una e Due Ante
Cerniere: ACX 02.01 e ACX 02.03

Single and Double Sash Casement Window
Hinges: ACX 02.01 e ACX 02.03

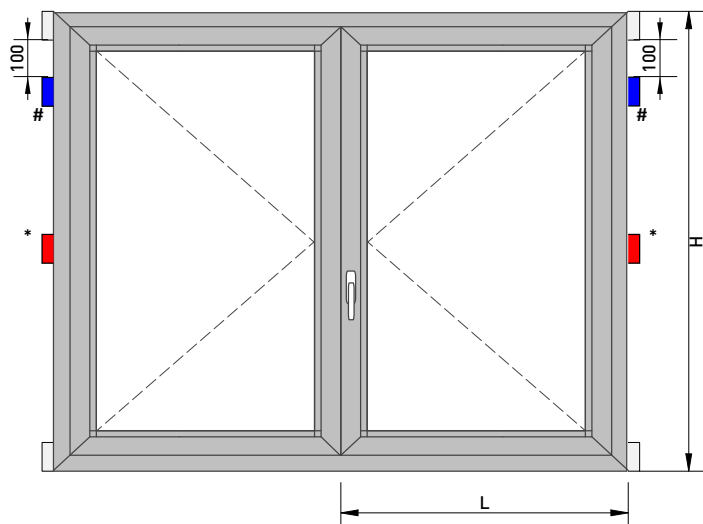
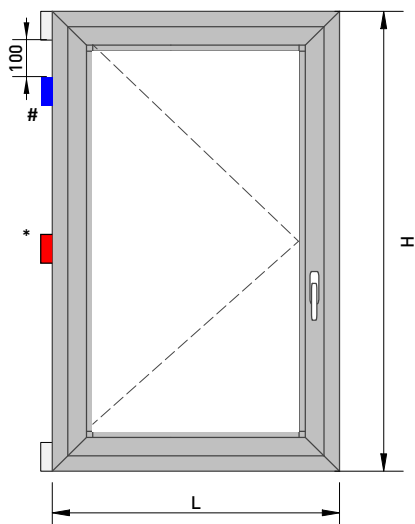

■ Dimensioni Anta Minima (LxH): ■ Minimum Sash Dimension (WxH):
430 mm. x 500 mm.

Norma per Stringa di Prodotto / Standard for Product String: EN 1935:2004

Tipo Type	(1) Cat. D'Uso Cat. of Use	(2) Durabilità Durability	(3) Massa Mass	(4) Resist. Fuoco Fire Resistance	(5) Sicurezza D'Uso Safety of Use	(6) Resist. Corrosione Corrosion Resist.	(7) Resist. Effrazione Breakage Resist.	(8) Grado Degree
ACX 02.01	1	4	2 (80Kg)	0	1	4	0	6
ACX 02.03	1	4	3 (80Kg)	0	1	4	0	9

Dimensioni Massime Anta (LxH) / Maximum Sash Size (WxL)

Anta Singola 2 Cerniere Single Sash 2 Hinges	Anta Singola 3 Cerniere Single Sash 3 Hinges	Anta Singola 4 Cerniere * + # Single Sash 4 Hinges * + #
1000x1600 mm.	1200x1800 mm.	1300x2100 mm.
Due Ante 2 Cerniere Double Sash 2 Hinges	Due Ante 3 Cerniere Double Sash 3 Hinges	Due Ante 4 Cerniere * + # Double Sash 4 Hinges * + #
1000x1500 mm.	1000x1700 mm.	1000x2100 mm.

Legenda Stringa di Prodotto / Product String Key

(1) Cat. D'Uso Cat. of Use	(2) Durabilità Durability	(3) Massa Mass	(4) Resist. Fuoco Fire Resistance	(5) Sicurezza D'Uso Safety of Use	(6) Resist. Corrosione Corrosion Resist.	(7) Effrazione Breakage	(8) Grado Degree
1= Leggero Lightweigh	3:10'000	2: 40Kg	0: Non Idoneo. Not Suitable	1: Soddisfatto. Met	4: 240h in nebbia salina in accordo a UNI EN 1670:2008. 240h in salt spray in accordance with UNI EN 1670:2008	1	Valore: Combinazione di Massa e cicli. Combination of Mass and Cycles
2= Medio Medium	4:25.000	3: 60 Kg					
3= Pesante Heavy	7:200.000	4: 80 Kg	1: Idoneo. Met				
4= Intenso vintense							



Battente Una e Due Ante
Cerniere a pettine: ACX 08.09

Single and Double Casement Window
Comb Hinges: ACX 08.09

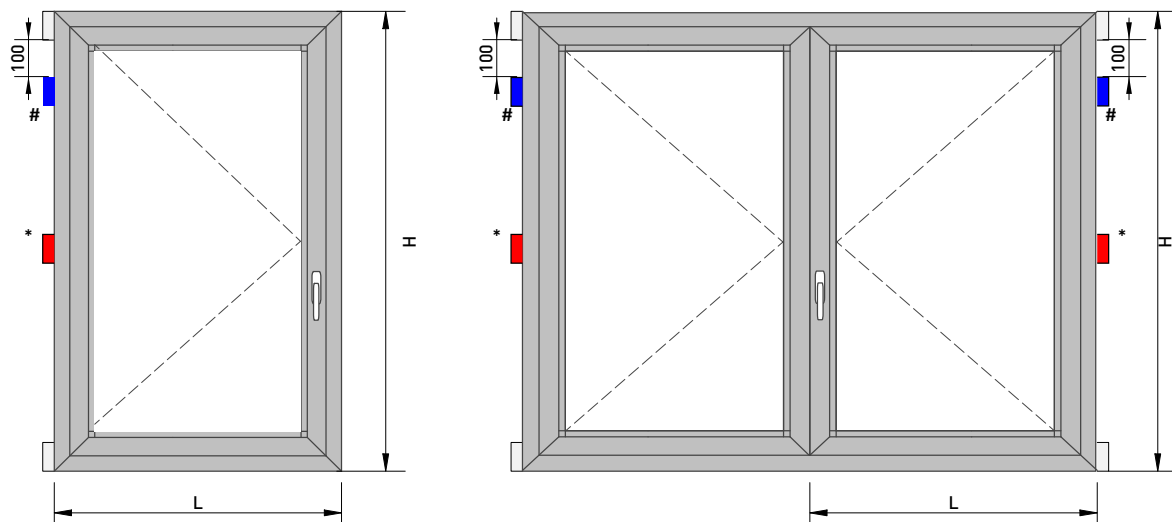

■ **Dimensioni Anta Minima (LxH):** ■ *Minimum Sash Dimension (WxH):*
430 mm. x 500 mm.

Norma per Stringa di Prodotto / Standard for Product String: EN 1935:2004

Tipo Type	(1) Cat. D'Uso Cat. of Use	(2) Durabilità Durability	(3) Massa Mass	(4) Resist. Fuoco Fire Resistance	(5) Sicurezza D'Uso Safety of Use	(6) Resist. Corrosione Corrosion Resist.	(7) Resist. Effrazione Breakage Resist.	(8) Grado Degree
ACX08.09	2	7	2 (80Kg)	0	1	4	0	7

Dimensioni Massime Anta (LxH) / Maximum Sash Size (WxL)

Anta Singola 2 Cerniere <i>Single Sash 2 Hinges</i>	Anta Singola 3 Cerniere <i>Single Sash 3 Hinges</i>	Anta Singola 4 Cerniere * + # <i>Single Sash 4 Hinges * + #</i>
1000x1600 mm.	1200x1800 mm.	1300x2100 mm.
Due Ante 2 Cerniere <i>Double Sash 2 Hinges</i>	Due Ante 3 Cerniere <i>Double Sash 3 Hinges</i>	Due Ante 4 Cerniere * + # <i>Double Sash 4 Hinges * + #</i>
1000x1500 mm.	1000x1700 mm.	1000x2100 mm.

Legenda Stringa di Prodotto / Product String Key

(1) Cat. D'Uso Cat. of Use	(2) Durabilità Durability	(3) Massa Mass	(4) Resist. Fuoco Fire Resistance	(5) Sicurezza D'Uso Safety of Use	(6) Resist. Corrosione Corrosion Resist.	(7) Effrazione Breakage	(8) Grado Degree
1= Leggero <i>Lightweigh</i>	3:10'000	2: 40Kg	0: Non Idoneo. <i>Not Suitable</i>	1: Soddisfatto. <i>Met</i>	4: 240h in nebbia salina in accordo a UNI EN 1670:2008. <i>240h in salt spray in accordance with UNI EN 1670:2008</i>	1	Valore: Combinazione di Massa e cicli. <i>Combination of Mass and Cycles</i>
2= Medio <i>Medium</i>	4:25.000	3: 60 Kg					
3= Pesante <i>Heavy</i>	7:200.000	4: 80 Kg	1: Idoneo. <i>Met</i>				
4= Intenso <i>vintense</i>							



Profili Porte Applicazione Esterna
Cerniere:
ACX 02.12 [2Alì] e ACX 02.13 [3 Alì]

Profiles for External Application
Hinges:
ACX 02.12 [2 Flaps] e ACX 02.13 [3 Flaps]

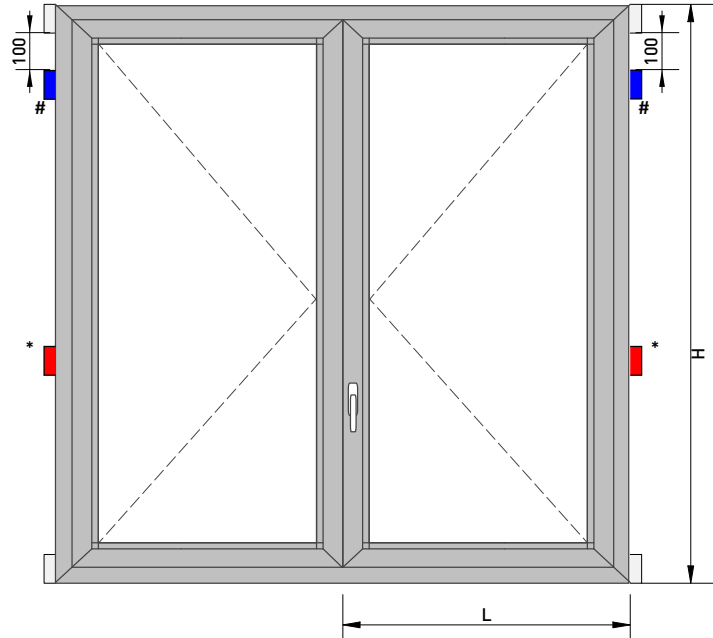
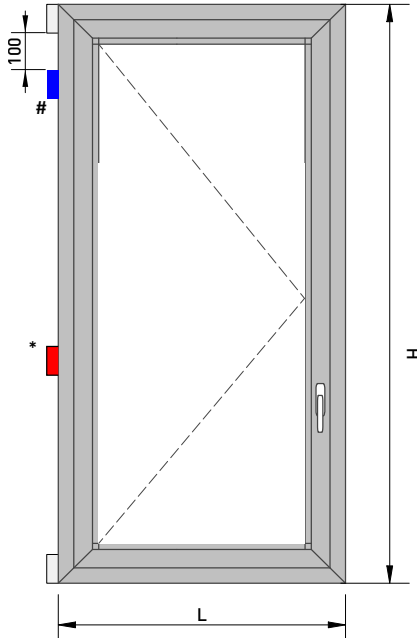

Norma per Stringa di Prodotto / Standard for Product String: EN 1935:2004

Tipo Type	(1) Cat. D'Uso Cat. of Use	(2) Durabilità Durability	(3) Massa Mass	(4) Resist. Fuoco Fire Resistance	(5) Sicurezza D'Uso Safety of Use	(6) Resist. Corrosione Corrosion Resist.	(7) Resist. Effrazione Breakage Resist.	(8) Grado Degree
ACX02.12	3	7	4 [160Kg]	0	1	4	0	11
ACX02.13	3	7	5 [200Kg]	0	1	4	0	12

Dimensioni Massime Anta (LxH) / Maximum Sash Size (WxL)

Anta Singola 2 Cerniere Single Sash 2 Hinges	Anta Singola 3 Cerniere Single Sash 3 Hinges	Anta Singola 4 Cerniere * + # Single Sash 4 Hinges * + #
1000x2200 mm.	1200x2200 mm.	1300x2200 mm.
Due Ante 2 Cerniere Double Sash 2 Hinges	Due Ante 3 Cerniere Double Sash 3 Hinges	Due Ante 4 Cerniere * + # Double Sash 4 Hinges * + #
800x2200 mm.	1000x2200 mm.	-

Legenda Stringa di Prodotto / Product String Key

(1) Cat. D'Uso Cat. of Use	(2) Durabilità Durability	(3) Massa Mass	(4) Resist. Fuoco Fire Resistance	(5) Sicurezza D'Uso Safety of Use	(6) Resist. Corrosione Corrosion Resist.	(7) Effrazione Breakage	(8) Grado Degree
1= Leggero Lightweigh	3:10'000	2: 40Kg	0: Non Idoneo. Not Suitable	1: Soddisfatto. Met	4: 240h in nebbia salina in accordo a UNI EN 1670:2008. 240h in salt spray in accordance with UNI EN 1670:2008	1	Valore: Combinazione di Massa e cicli. Combination of Mass and Cycles
2= Medio Medium	4:25.000	3: 60 Kg					
3= Pesante Heavy	7:200.000	4: 80 Kg	1: Idoneo. Met				
4= Intenso vintense							



Aperture Oscillo battenti (140 Kg.) Una e Due Ante
Cerniere: ACX 08.01 e ACX 08.01L

Tilt&turn Openings (140 Kg.) Single and Double Sash
Hinges: ACX.08.01 and ACX.08.01L

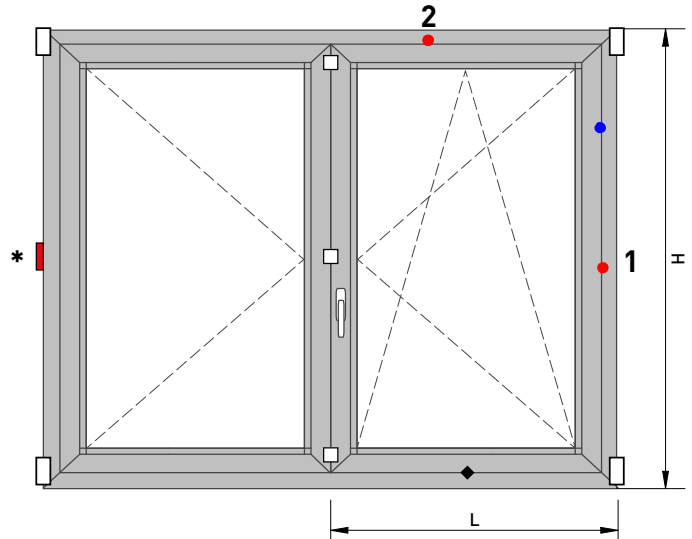
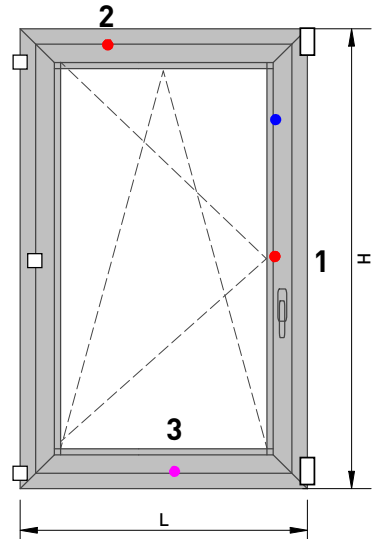

Punti di chiusura | **Locking Points**
 su KIT base / on Base KIT
 □ ACX 08.01 ◆ □ ACX 08.01L

Punti di chiusura Supplementari | **Additional Locking Points**
 su KIT base / on Base KIT
 ● ACX 08.06 ● ACX 08.16 ● ACX 08.16

Norma per Stringa di Prodotto / Standard for Product String: EN 13126-8:2006

Tipo Type	(1) Cat. D'Uso Cat. of Use	(2) Durabilità Durability	(3) Massa Mass	(4) Resist. Fuoco Fire Resistance	(5) Sicurezza D'Uso Safety of Use	(6) Corrosione Corrosion	(7) Effrazione Breakage	(8) Applicazione Application	(9) Dim Provino Test Size
ACX 08.01	-	4	140 Kg	0	1	4	-	11	1550x1400
ACX 08.01L	-	4	140 Kg	0	1	4	-	12	1550x1400

Limiti Dimensionali per Braccio Corto | Size Limits for Short Arm: ACX 08.22 | ACX 08.22L

	Anta Singola (LxH) Single Sash (WxL)	Anta Doppia (LxH) Double Sash (WxL)	Punti di Chiusura Locking Points
MIN	395x500 mm.	395x500 mm.	ACX 08.01 - ACX 08.01L
MAX	450x500 mm.	450x500 mm.	ACX 08.01 - ACX 08.01L

Limiti Dimensionali per Braccio Medio | Size Limits for Medium Arm: ACX 08.03 | ACX 08.22L

	Anta Singola (LxH) Single Sash (WxL)	Anta Doppia (LxH) Double Sash (WxL)	Punti di Chiusura Locking Points
MIN	451x500 mm.	451x500 mm.	ACX 08.01 - ACX 08.01L
MAX	650x1200 mm.	650x1200 mm.	KIT + ACX 08.06
MAX	650x2200 mm.	650x2200 mm.	KIT + ACX 08.06 + ACX 08.16

Limiti Dimensionali per Braccio Corto | Size Limits for Short Arm: ACX 08.24 | ACX 08.24L

	Anta Singola (LxH) Single Sash (WxL)	Anta Doppia (LxH) Double Sash (WxL)	Punti di Chiusura Locking Points
MIN	651x600 mm.	651x600 mm.	ACX 08.01 - ACX 08.01L
MAX	651x1400 mm.	651x1400 mm.	ACX 08.01 - ACX 08.06
MAX	651x2200 mm.	651x2200 mm.	KIT + ACX 08.06 - ACX 08.16
MAX	1200x1400 mm.	1200x1400 mm.	KIT + ACX 08.06 - ACX 08.16 [Qt. x2]
MAX	1200x2200 mm.	1200x2200 mm.	KIT + ACX 08.06 - ACX 08.16 [Qt. x3]
MAX	1200x2200 mm.	-	KIT + ACX 08.06 - ACX 08.16 [Qt. x3]
MAX	1200x2200 mm.	-	-

Legenda Stringa di Prodotto / Product String Key

(1) Cat. D'Uso Cat. of Use	(2) Durabilità Durability	(3) Massa Mass	(4) Resist. Fuoco Fire Resistance	(5) Sicurezza D'Uso Safety of Use	(6) Corrosione Corrosion	(7) Effrazione Breakage	(8) Applicazione Application	(9) Dim Provino Test Size
-	4:15,000 a/r+5,000 Battente (Swing)	Portata Certificata (Certification Scope)	0: Non Idoneo 0: Not Met	1: Soddisfatto 1: Met	4: 240h UNI EN 1670:2008	-	8: Privato 8: Private	Dimensioni Campione Test Dimension



LA MARCATURA CE DELLE FINESTRE E PORTE PEDONALI [Senza caratteristiche di resistenza al fuoco e/o di tenuta al fumo]

Il marchio CE, apposto sui prodotti da costruzione, attesta la loro conformità ai requisiti essenziali definiti dalla direttiva 89/106/CE "Prodotti da costruzione", emanata dal Consiglio della Comunità Europea il 21/12/1988 ed attuata, in Italia, dal D.P.R. n. 246 del 21/04/1993. La marcatura CE di uno specifico prodotto da costruzione diviene obbligatoria, al fine di immettere il prodotto in un mercato della Comunità Europea, allorché sia stata emessa dal CEN, su mandato della Comunità Europea, una "specificazione tecnica" (norma o benessere tecnico) che regolamenti la sua applicazione.

La responsabilità per la verifica dei requisiti del prodotto e per l'apposizione della marcatura CE spetta al suo fabbricante.

Al fine di garantire i requisiti richiesti dalle relative norme, il fabbricante è tenuto a:

- ◆ **Predisporre un piano di controllo della produzione (FPC). E' un sistema di procedure e controlli da eseguire durante le fasi di produzione**
- ◆ **Effettuare delle "prove iniziali di tipo" (ITT) sul prodotto al fine di determinare le prestazioni. Le modalità di prova dei requisiti del prodotto sono definite dalle norme richiamate dalla specifica norma prodotto".**

Alcune prove possono essere eseguite dal produttore stesso, secondo le disposizioni delle relative norme armonizzate, mentre altri requisiti sono di competenza di laboratori in possesso di una notifica attribuita loro dallo stato membro di appartenenza (organismi notificati).

IL FABBRICANTE PUO' PROCEDERE IN PIU' MODI

- ◆ **Eseguire autonomamente i test sui propri prodotti presso un istituto Notificato, diventando quindi titolare degli ITT**
- ◆ **Far riferimento ai risultati di prove effettuate dal detentore del sistema di serramento, purché quest'ultimo abbia espresso il proprio consenso per mezzo di un contratto di licenza d'uso stipulato tra le parti.**

Da Febbraio 2010 è obbligatoria la marcatura CE per finestre e porte pedonabili senza caratteristiche di resistenza al fuoco e tenuta al fumo.

L'appendice ZA della norma UNI EN 14351-1 specifica le caratteristiche essenziali per finestre e porte e attribuisce le competenze delle prove iniziali di tipo.

Il requisito relativo ad una determinata caratteristica non è applicabile in quegli Stati Membri nei quali non sussistono requisiti di regolamentazione per tale caratteristica per l'impiego previsto del prodotto. In questo caso, i fabbricanti che immettono i loro prodotti sul mercato di questi Stati membri non sono obbligati a determinare né a dichiarare le prestazioni dei loro prodotti in relazione a questa caratteristica e può essere utilizzata l'opzione "Nessuna Prestazione Determinata" (NPD) nelle informazioni che accompagnano la marcatura CE (vedere punto ZA.3). Tuttavia, l'opzione NPD non può essere utilizzata nel caso in cui la caratteristica sia soggetta a un livello soglia. (Citazione integrale tratta dalla norma UNI EN 14351-1 - appendice ZA)

CE MARKING OF PEDESTRIAN WINDOWS AND DOORS [Without fire resistance and/or smoke resistance characteristics]

The CE marking, affixed to products, certifies their compliance with the essential requirements of Directive 89/106/EC "Construction products", issued by the Council of the European Community on 21/12/1988 and implemented, in Italy, by Presidential Decree no. 246 of 21/04/1993. The CE marking of a specific product is mandatory when the product is to be placed on a European Community market, whenever a "technical specification" (standard or technical approval) that regulates its application has been issued by CEN, under mandate of the European Community.

The manufacturer is responsible for verifying product requirements and affixing the CE marking. To ensure fulfilment of the requirements of the relevant standards, the manufacturer must:

- ◆ **Draw up a production control plan (PCP). This system of procedures and controls are performed during the production stages.**
- ◆ **Carry out "initial type tests" (ITT) on the product in order to determine performance. The test methods of the product requirements are defined by the standards referred to in the specific product standard".**

Some tests can be carried out by the manufacturer, in accordance with the provisions of the relevant harmonised standards, while others are the responsibility of laboratories awarded notified body status by their Member State (notified bodies).

THE MANUFACTURER MAY PROCEED IN SEVERAL WAYS:

- ◆ **Carry out the tests on its products independently at a Notified Body, thus becoming the holder of the ITTs**
- ◆ **Refer to the results of tests carried out by the holder of the window and door system, provided that the latter has given his consent by means of a user licence agreement signed by the parties.**

From February 2010, CE marking is mandatory for pedestrian windows and doors without fire resistance and smoke resistance characteristics.

Appendix ZA of standard UNI EN 14351-1 specifies the essential characteristics for windows and doors and attributes responsibilities for the initial type tests.

The requirement for a given characteristic does not apply in the Member States where there are no regulatory requirements for that characteristic for the intended use of the product. In this case, manufacturers who place their products on the market of these Member States shall not be obliged to determine or to declare the performance of their products for same characteristic and the "No Performance Determined" (NPD) option may be used in the information accompanying the CE marking (see point ZA.3). However, the NPD option cannot be used when the characteristic is subject to a threshold level. (Full quote from UNI EN 14351-1 - Appendix ZA)



Per finestre e porte senza funzione di compartimentazione del fuoco o fumo e non poste nelle vie di fuga (sistema di attestazione della conformità 3):

For windows and doors without a fire or smoke compartmentalization function and not located in run off areas (conformity attestation system 3):

CARATTERISTICHE FONDAMENTALI FUNDAMENTAL CHARACTERISTICS	Espressioni di Prestazione Expressions of Performance	Competenze Prove Iniziali Tipo Initial Type Test Responsibilities		
		ON= Organismo Notificato; PR= Produttore ON=Notified Body; PR= Manufacturer		
		Finestre Windows	Porte Doors	Lucernari Hopper Windows
Comportamento al FUOCO Dall'Esterno <i>External Fire Behaviour</i>				ON
Resistenza al FUOCO <i>Fire Reaction</i>	Euroclassi <i>Euroclasses</i>			ON
Tenuta all'ACQUA <i>Watertightness</i>	Classi Tecniche <i>Technical Classes</i>	ON	ON	ON
Sostanze Pericolose <i>Hazardous Substances</i>		ON	ON	
Resistenza al Carico del VENTO <i>Wind Load Resistance</i>	Classi Tecniche <i>Technical Classes</i>	ON	ON	PR
Resistenza al Carico della NEVE e Carico Permanente <i>Snow Load and Permenent Load</i>	Classi Tecniche <i>Technical Classes</i>			PR
Resistenza all'URTO <i>Shock Resistance</i>	KN/m² <i>KN/sqm</i>		PR	ON
Capacità Portante dei Dispositivi di Sicurezza <i>Load-bearing Capacity of Savety evices</i>	Soglia	ON	ON	ON
Altezza <i>Height</i>	mm.		PR	
Forze di azionamento (solo dispositivi automatici) <i>Operating forces (automatic devices only)</i>	Classi Tecniche <i>Technical Classes</i>		ON	
Prestazione acustica <i>Acoustic Performance</i>	dB	ON	ON	ON
Trasmittanza termica <i>Heat Transmittance</i>	W/m²K	ON	ON	ON
Proprietà radioattive <i>Radioactive properties</i>				PR
Permeabilità all'ARIA <i>AIR Permeability</i>	Classi Tecniche <i>Technical Classes</i>	ON	ON	PR

La valutazione delle caratteristiche da dichiarare è funzione della destinazione d'uso del prodotto e della legislazione vigente nello Stato Membro, ove esso è immesso.

The characteristics to be declared depend on the intended use of the product and the legislation in force in the Member State where it is sold.



TEST INIZIALI di TIPO (ITT)

La serie riportata nel presente catalogo è stata sottoposta a test iniziali di tipo (ITT) relativamente ai requisiti previsti dalla norma prodotto UNI EN 14351-1. I risultati dei test iniziali di tipo sono estendibili a serramenti di differente tipologia e con differenti dimensioni e componenti, secondo le indicazioni fornite dalla norma EN 14351-1 in Appendice A (interdipendenza fra le caratteristiche e i componenti), Appendice E (determinazione delle caratteristiche) ed Appendice F (selezione facoltativa di provini rappresentativi per le finestre)

Il costruttore di serramenti ha la responsabilità di verificare la rispondenza del serramento prodotto rispetto al campione sottoposto a prova. Il consorzio TWIN Systems mette a disposizione dei propri clienti i risultati dei test effettuati, a seguito della stipulazione di un contratto d'uso gratuito degli stessi.

Dichiarazione di Conformità

Il fabbricante del serramento è tenuto a consegnare al committente una dichiarazione di conformità la quale, in accordo alla norma UNI EN 14351-1, deve includere :

- ◆ **Nome ed indirizzo del fabbricante o del suo rappresentante autorizzato con sede nella EEA;**
- ◆ **Descrizione del prodotto (tipo, identificazione, impiego, ecc.) e una copia delle informazioni che accompagnano la marcatura CE;**
- ◆ **Disposizioni alle quali il prodotto è conforme (appendice AZ della norma prodotto UNI EN 14351-1);**
- ◆ **Condizioni particolari applicabili all'impiego del prodotto (per esempio disposizioni per l'impiego in determinante condizioni, ecc.);**
- ◆ **Nome e indirizzo del/i laboratorio/i approvato/i.**
- ◆ **Nome e qualifica della persona incaricata di firmare la dichiarazione per conto del fabbricante o del suo rappresentante autorizzato.**

La dichiarazione e il certificato devono essere presentati nella lingua o nelle lingue ufficiali dello Stato Membro in cui il prodotto deve essere utilizzato.

Etichettatura e Marcatura

Il fabbricante deve fornire informazioni sufficienti ad assicurare la rintracciabilità del suo prodotto fornendo il collegamento fra il prodotto, il fabbricante e la produzione. Queste informazioni devono essere contenute su un'etichetta o specificate in documenti di accompagnamento nelle specifiche tecniche pubblicate dal fabbricante. Le informazioni seguenti devono accompagnare il simbolo di marcatura CE:

- ◆ **Nome e indirizzo registrato o marchio di identificazione del fabbricante;**
- ◆ **Ultime due cifre dell'anno in cui la marcatura CE è stata applicata;**
- ◆ **Riferimento alla norma di prodotto (EN 14351-1);**
- ◆ **Descrizione del prodotto: nome generico, materiale, dimensioni, ecc. e impiego previsto;**
- ◆ **Informazioni sulle caratteristiche essenziali che devono essere dichiarate presentate come:**
- ◆ **Valori dichiarati o livelli e/o classi;**
- ◆ **NPD - " Nessuna prestazione determinata" per le caratteristiche quando è pertinente.**

INITIAL TYPE TESTS (ITT)

The series in this catalogue has been subjected to initial type tests (ITT) for the requirements of product standard UNI EN 14351-1.

The results of the initial type tests can be extended to doors and windows of different types and of different sizes and compositions, according to the indications provided for by EN 14351-1 in Appendix A (interdependence between the characteristics and compositions), Appendix E (determination of characteristics) and Appendix F (optional selection of representative samples for the windows).

The door and window manufacturer is responsible for verifying compliance of the window with the sample under test. The TWIN Systems consortium makes the results of the test performed available to its customer, after the free usage agreement has been signed.

Declaration of Conformity

The window and door manufacturer must provide the customer with a declaration of conformity which, in accordance with UNI EN 14351-1, must include:

- ◆ **Name and address of the manufacturer or its authorised representative established in the EEA;**
- ◆ **Description of the product (type, identification, use, etc.) and a copy of the information accompanying the CE marking;**
- ◆ **Provisions with which the product complies (Appendix AZ of product standard UNI EN 14351-1);**
- ◆ **Special conditions applicable to the use of the product (e.g. provisions for use under certain conditions, etc.);**
- ◆ **Name and address of the approved laboratory(ies).**
- ◆ **Name and capacity of the person empowered to sign the declaration on behalf of the manufacturer or his authorised representative.**

The declaration and certificate must be done in the official language or languages of the Member State where the product is to be used.

Labelling and Marking

The manufacturer must provide sufficient information to ensure the traceability of the product providing the link between the product, the manufacturer and the production. This information must be contained on a label or specified in accompanying documents in the technical specifications published by the manufacturer. The following information must accompany the CE marking symbol:

- ◆ **Manufacturer's name and registered address or identification mark;**
- ◆ **Last two digits of the year in which the CE marking was applied;**
- ◆ **Reference to the product standard (EN 14351-1);**
- ◆ **Description of the product: generic name, material, size, etc. and intended use;**
- ◆ **Information about the essential characteristics that must be declared:**
- ◆ **Declared values or levels and/or classes;**
- ◆ **NPD - " No Performance Determined" for characteristics when relevant.**



Il simbolo della marcatura CE e le informazioni di accompagnamento devono essere apposti in modo visibile, leggibile e indelebile in una o più delle posizioni seguenti (gerarchia di preferenza del fabbricante):

Qualsiasi parte idonea del prodotto stesso, purché sia assicurata la visibilità quando si aprono le ante; Su un'etichetta attaccata; Sul suo imballaggio; Sul documento commerciale di accompagnamento.

DOCUMENTAZIONE TECNICA DI ACCOMPAGNAMENTO

Il fabbricante deve fornire informazioni su quanto segue:

- *Immagazzinaggio e movimentazione, se il fabbricante non è responsabile dell'installazione del prodotto;*
- *Requisiti e tecniche d'installazione (sul posto), se il fabbricante non è responsabile dell'installazione del prodotto (Guida UNCSAAL)*
- *Manutenzione e pulizia (Manuale Consorzio TWIN SYSTEMS)*
- *Istruzioni d'uso finali incluse le istruzioni per la sostituzione di componenti*
- *Istruzioni per l'uso in condizioni di sicurezza.*

In Italia i requisiti obbligatori per la Marcatura CE sono:

- *Permeabilità dell'aria*
- *Trasmittanza termica*
- *Proprietà radiative (Fattore solare g, Trasmissione luminosa (TV))*

In Spagna e in Portogallo i requisiti obbligatori per la Marcatura CE sono:

- *Permeabilità all'aria*
- *Tenuta all'acqua*
- *Resistenza al vento*
- *Trasmittanza termica*
- *Isolamento acustico*

The CE marking and accompanying information must be affixed in a visible, legible and indelible way in one or more of the following positions (manufacturer's hierarchy of preference):

Any suitable part of the product itself, provided that visibility is ensured when opening the doors; On an attached label; On its packaging; On the accompanying commercial document.

ACCOMPANYING TECHNICAL DOCUMENTATION

The manufacturer will provide information about:

- *Storage and handling, if the manufacturer is not responsible for the installation of the product*
- *Requirements and installation methods (on site), if the manufacturer is not responsible for the installation of the product (UNCSAAL Guide)*
- *Maintenance and cleaning (TWIN SYSTEMS Consortium Manual)*
- *Final instructions for use including instructions for replacing components; Instructions for safe use.*

In Italy, the mandatory requirements for CE marking are:

- *Air permeability*
- *Heat Transmittance*
- *Radiative properties (Solar factor g, Light transmission (TV)).*

In Spain and Portugal the mandatory requirements for CE marking are :

- *Air permeability*
- *Watertightnes*
- *Wind resistance*
- *Heat Transmittance*
- *Sound insulation*



TRASMITTANZA TERMICA DEI SERRAMENTI

HEAT TRANSMISSION OF WINDOWS

E' necessario sapere che le prescrizioni dettate dal decreto ministeriale cambiano in funzione della tipologia di intervento edilizio (nuova costruzione, ristrutturazione importante di primo oppure secondo livello, riqualificazione energetica) e si applicano ad edifici sia pubblici sia privati.

Per edifici di nuova costruzione si intendono quei fabbricati il cui titolo abilitativo sia stato richiesto dopo l'entrata in vigore del decreto.

Sono assimilati agli edifici di nuova costruzione gli edifici sottoposti a demolizione e ricostruzione, qualunque sia il titolo abilitativo necessario, e gli ampliamenti di edifici esistenti la cui nuova porzione abbia un volume lordo climatizzato superiore al 15% di quello esistente o comunque superiore a 500 m³.

Per interventi di ristrutturazione importante di primo livello si intendono quelli che interessano l'involucro edilizio con un'incidenza superiore al 50 per cento della superficie disperdente lorda complessiva dell'edificio, comprendendo anche la ristrutturazione dell'impianto termico per il servizio di climatizzazione invernale e/o estiva asservito all'intero edificio.

Per interventi di ristrutturazione importante di secondo livello si intendono quelli che interessano l'involucro edilizio con un'incidenza superiore al 25 per cento della superficie disperdente lorda complessiva dell'edificio e possono interessare l'impianto termico per il servizio di climatizzazione invernale e/o estiva.

Negli interventi di riqualificazione energetica rientrano gli interventi non riconducibili agli interventi succitati e che hanno un impatto sulla prestazione energetica dell'edificio. Rientrano quindi anche:

- Le ristrutturazioni che interessano l'involucro edilizio con un'incidenza inferiore o uguale al 25% della superficie disperdente lorda complessiva dell'edificio e/o consistono nella nuova installazione, nella ristrutturazione di un impianto termico asservito all'edificio o di altri interventi parziali, ivi compresa la sostituzione del generatore;
- Gli ampliamenti di edifici esistenti la cui nuova porzione abbia un volume lordo climatizzato inferiore o uguale al 15% di quello esistente o comunque inferiore a 500 m³.

Per gli edifici di nuova costruzione e per quelli sottoposti a ristrutturazioni di primo livello, non sono previsti specifici limiti di trasmittanza termica da rispettare per le chiusure trasparenti. Sussiste l'obbligo di rispettare limiti per quanto concerne altri parametri tecnici che connotano gli impianti, l'involucro edilizio e l'edificio nel loro complesso (per esempio coefficiente medio globale di scambio termico per trasmissione per unità di superficie disperdente HT' - area solare equivalente estiva per unità di superficie utile Asol,est/Asup utile - indice di prestazione termica utile per riscaldamento EPH,nd - indice di prestazione termica utile per il raffrescamento EPC,nd - indice di prestazione energetica globale dell'edificio EPgl,tot, ecc.) contenuti nell'Allegato A del decreto

Note that the requirements as of the ministerial decree depend on the type of construction (new construction, major first or second level renovation, energy upgrading) and apply to both public and private buildings.

New buildings are those whose building permit has been requested following the promulgation of the decree.

Buildings subject to demolition and reconstruction, irrespective of the type of building permit, and extensions to existing buildings whose new portion has a gross air-conditioned volume of more than 15% of the existing one or in any case more than 500 m³ are considered new buildings.

Major first level renovations are those affecting the building shell with an impact of more than 50% of the building's total gross dispersant surface, also including the renovation of the heating system for the winter and/or summer air conditioning service of the entire building.

For major second-level renovation interventions, those that concern the building shell with an impact of more than 25 percent of the building's total gross dispersant surface and can regard the heating plant system for the winter and/or summer air conditioning service.

Energy upgrading works include activities that are not attributable to the aforementioned activities and that have an impact on the building's energy performance. The following are therefore also included:

- Renovations that affect the building shell with an impact of less than or equal to 25% of the building's total gross dispersant surface and/or the new installation or upgrading of the building's heating plant or other partial works, including the replacement of the generator;
- Extensions of existing buildings whose new portion has a gross air-conditioned volume of less than or equal to 15% of the existing one or in any case less than 500 m³.

For new buildings and buildings undergoing first level renovations, there are no specific heat transmission limits to be respected for transparent doors. There is an obligation to respect the limits of other technical parameters that characterise the plants, shell and building as a whole (for example, average overall heat exchange coefficient for transmission by dispersant surface unit HT' - equivalent summer solar area per unit of surface area Asol,est/Asup - useful heat performance index for heating EPH,nd - heat performance index for cooling EPC,nd - overall energy performance index of the building EPgl,tot, etc.) contained in Annex A of the decree



I limiti dell'Allegato A sul coefficiente medio globale di scambio termico per trasmissione per unità di superficie disperdente HT' sono da rispettare anche per gli interventi di ristrutturazione importante di secondo livello.

Nell'ambito degli interventi di ristrutturazione importante di secondo livello e degli interventi di riqualificazione energetica sono invece da rispettare i limiti riportati nell'Appendice B del decreto relativamente:

- Alla trasmittanza termica U_w dei serramenti (**trasparenti, opachi**) e dei cassonetti **posti a delimitazione di ambienti climatizzati verso l'esterno oppure verso ambienti non climatizzati (cfr. tabella 1);**
- Al fattore di trasmissione solare totale g_{gl+sh} dei serramenti vetriati in combinazione con schermature solari mobili **posizionati sui fronti dell'edificio SUD, EST, OVEST, SUD-EST, SUD-OVEST (cfr. tabella 2).**

The limits of Annex A on the overall average coefficient of heat exchange through transmission by unit of dispersant surface HT' must also be respected for major second-level renovations.

In the case of major second level renovations and energy upgrading works, the limits set out in Appendix B of the decree must be respected for:

- Heat transmission U_w of the windows (transparent, opaque) and shutter boxes positioned to delimit air-conditioned environments towards the outside or towards non-conditioned environments (see table 1);
- The total solar transmission factor g_{gl+sh} glazed windows in combination with mobile solar shields positioned on the SOUTH, EAST, WEST, SOUTH-EAST, SOUTH-WEST building façades (see table 2).

Tabella/Table 1

Valori limite della trasmittanza U_w dei serramenti (trasparenti, opachi) e dei cassonetti posti a delimitazione di ambienti climatizzati verso l'esterno oppure verso ambienti non climatizzati.

ZONA CLIMATICA	U_w [W/m ² K]	
	2021	ECOBONUS
Zona A	3.00	2.60
Zona B	3.00	2.60
Zona C	2.00	1.75
Zona D	1.80	1.67
Zona E	1.40	1.30
Zona F	1.00	1.00

Tabella/Table 2

Valori limite del fattore di trasmissione solare totale g_{gl+sh} chiusure trasparenti in presenza di schermature solari mobili installate su fronti dell'edificio SUD, EST, OVEST, SUD-EST, SUD-OVEST

ZONA CLIMATICA CLIMATIC ZONE	g_{gl+sh}
	2021
Zone TUTTE ALL ZONES	0.35

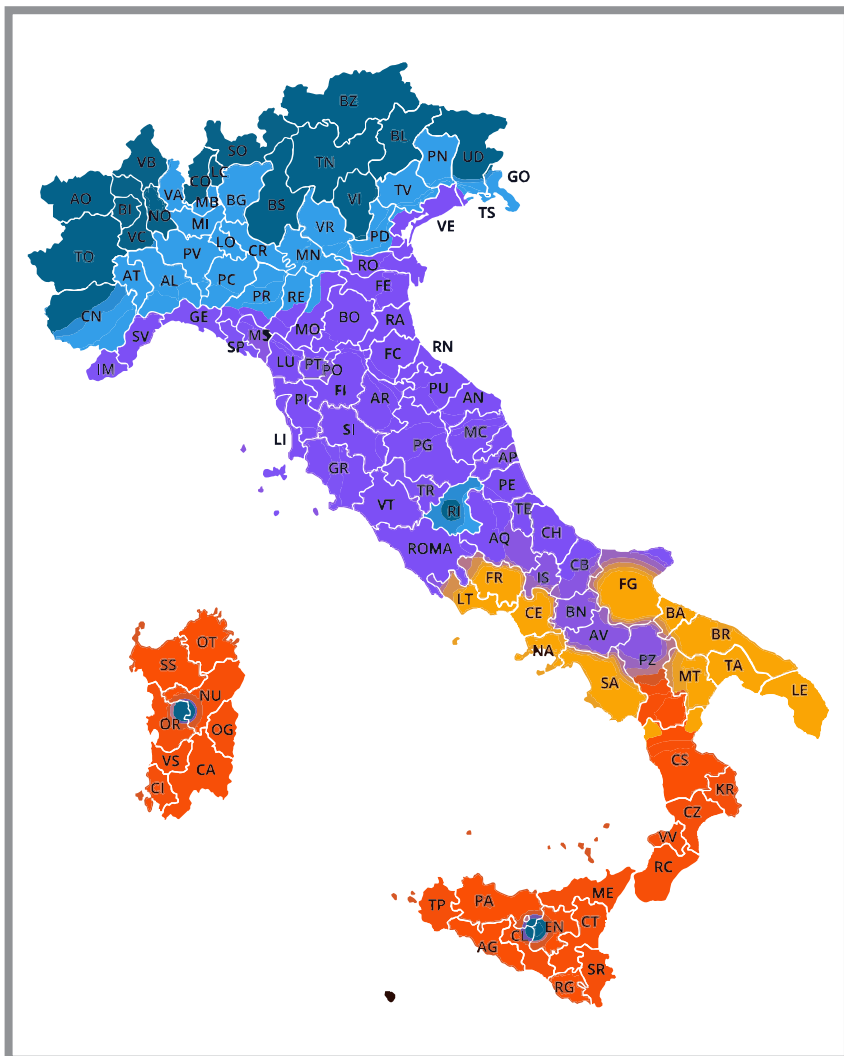



VALUTAZIONE DELLA PRESTAZIONE TERMICA DEI SERRAMENTI

TRASMITTANZA TERMICA:

La trasmittanza termica rappresenta il parametro più significativo per la valutazione del comportamento termico di un prodotto edilizio: minore è il suo valore migliore è la prestazione termica posseduta dal componente stesso.

Il calcolo semplificato della trasmittanza termica del componente finestrato U_w composta da un singolo serramento e relativo vetro (o pannello) si esegue con la formula:

VALUTAZIONE DELLA PRESTAZIONE TERMICA DEI SERRAMENTI

HEAT TRANSMISSION:

Heat transmission is the most significant factor in the evaluation of the thermal performance of a building product: the lower its value, the higher the thermal performance of the product.

The simplified heat transmission calculation of the product glazing U_w comprising a single window and related glass (or panel) the formula is:

$$U_w = \frac{A_g U_g + A_f U_f + l_g \emptyset_g}{A_g + A_f}$$

■ A_g : Area del vetro in m^2

■ U_g : Trasmittanza termica riferito all'area centrale della vetrata, e non include l'effetto del distanziatore del vetro lungo il bordo della vetrata stessa

■ A_f : Area del telaio

■ U_f : Trasmittanza termica del telaio applicabile in assenza della vetrata

■ l_g : Lunghezza del perimetro del vetro

■ \emptyset_g : Trasmittanza termica lineare concernente la conduzione di calore supplementare che avviene a causa dell'interazione tra telaio, vetri e distanziatore dei vetri in funzione delle proprietà termiche di ognuno di questi componenti e si rileva, secondo quanto precisato nell'allegato E della norma UNI EN ISO 10077-1, preferibilmente con il calcolo numerico eseguito in accordo con la norma ISO 10077-2; quando non sono disponibili i risultati di calcolo dettagliati ci si può riferire ai prospetti E.1 ed E.2 i quali indicano i valori \emptyset_g di default per le tipiche combinazioni di telai, vetri e distanziatori.

■ A_g : Area of the glass in m^2

■ U_g : Heat transmission of the central area of the window, not including the effect of the glass spacer along the edge of the window

■ A_f : Frame area

■ U_f : Heat transmission of the frame applicable in absence of the glass

■ l_g : Length of the perimeter of the glass

■ \emptyset_g : Linear heat transmission concerning the additional heat conduction that occurs due to the interaction between the frame, glass and spacer of the glass as a function of the thermal properties of each of these components and it is noted, as specified in Annex E of standard UNI EN ISO 10077-1, preferably with the numerical calculation performed in accordance with ISO 10077-2; when the detailed calculation results are not available you can refer to the default \emptyset_g for the typical combinations of frames, glass and spacers.

ESTENDIBILITÀ

L'appendice F della norma di prodotto UNI EN 14351-1 suggerisce le tipologie di serramento rappresentative e le relative estensioni, ma essendo la tabella puramente informativa, sta allo stesso produttore scegliere i campioni.

EXTENSIBILITY

Appendix F of the product standard UNI EN 14351-1 suggests the types of typical windows and their extensions, but since the table is purely informative, it is up to the manufacturer to choose the samples.

TIPO DI FINESTRA WINDOW TYPE	POSSIBILE ESTENSIONE Possible Extension
Anta FISSA <i>Fixed</i>	Finestra Battente/Ribalta <i>Tilt & Turn Window</i>
Porta Finestra ad Anta Singola (Apertura Interna o Esterna) <i>Single door window (internal or external opening)</i>	
Finestra Anta Singola con Ribalta <i>Single Sash Tilt & Turn Window</i>	
Finestra con DUE o più Porte (Apertura Interna o Esterna) <i>Window with two or more doors (internal or external opening)</i>	Stessa Tipologia <i>Same Type</i>
Finestra a UNA o DUE ante orizzontali scorrevoli <i>Window with ONE or TWO horizontal sliding sashes</i>	
Finestra con DUE Ante Scorrevoli <i>Window with TWO Sliding Sashes</i>	Stessa Tipologia <i>Same Type</i>
Finestra a UNA o DUE ante orizzontali scorrevoli con Ribalta <i>Window with ONE or TWO horizontal sliding sashes with Tilt & Turn</i>	Stessa Tipologia <i>Same Type</i>
Bilico Orizzontale o Verticale <i>Horizontal or vertical pivoting window</i>	Stessa Tipologia <i>Same Type</i>
Finestra a Soffietto <i>Folding Window</i>	Stessa Tipologia <i>Same Type</i>

La norma UNI EN 14351-1 prevede che il calcolo effettuato su di un serramento aventi dimensioni:

1230 (±25%) x 1480 (-25%)
1480 (+25%) x 2180 (±25%)

Le analisi termiche effettuate con le misure sopra descritte, possono essere estese a tutti i serramenti di tutte le dimensioni, purché il vetro utilizzato abbia come valore di U_g uguale o inferiore a $1.9 \text{ w/m}^2\text{K}$, altrimenti la norma delle regole di estensione dei valori calcolati sull'infisso normalizzato ad infissi di diverse dimensioni.

Ovviamente i calcoli devono essere effettuati sulle stesse tipologie di infissi, e s'intende che una modifica del componente modifica la caratteristica in questione. In termini di prestazioni termiche è ovvio che andando a togliere o ad aggiungere elementi (per esempio passare da una finestra ad una anta, da una a due e così via), determina un variazione dei valori finali.

The UNI EN 14351-1 standard sets forth the calculation carried out on a window with dimensions:

1230 (±25%) x 1480 (-25%)
1480 (+25%) x 2180 (±25%)

The thermal analyses carried out with the measurements described above can be extended to doors and windows of all sizes, provided that the glass used has a U_g value equal to or less than $1.9 \text{ w/m}^2\text{K}$, otherwise the standard of the rules of the values calculated on the normalised frame is extended to frames of different sizes.

Obviously, the calculations must be carried out on the same types of frames, and it is understood that any modification to the component changes the characteristic in question. In terms of thermal performance, it is clear that, removing or adding elements (for example, switching from a window with one door to one with two doors, and so on) results in a change in the final values.



POSA QUALITÀ

IL MARCHIO

Il Marchio Posa Qualità Serramenti distinguerà i migliori costruttori italiani di serramenti di tutti i materiali, offrendo ai consumatori italiani uno strumento tangibile per distinguere le migliori aziende con una garanzia assicurativa post vendita sul prodotto installato fino a 10 anni.

In questo modo il costruttore di serramenti potrà qualificare al cliente non solo le prestazioni «astratte» di un serramento, bensì quelle reali, una volta installato, potrà attestare la qualificazione della propria Azienda e potrà garantire nel tempo ciò che ha venduto.

Perché un Marchio rigoroso sulla Posa è l'unica forma di garanzia tangibile da offrire al consumatore.

Il progetto Marchi Posa Qualità prevede un piano di formazione che coinvolgerà tutta la filiera industriale del serramento, un Marchio che certificherà la qualità della progettazione della posa attraverso severi test di laboratorio e un Marchio che garantirà e verificherà la sua corretta esecuzione attraverso controlli a campione.

il consorzio TWIN SYSTEMS è certificato PROGETTAZIONE Posa Qualità Serramenti dal 2020. I suoi consorziati organizzano periodicamente corsi professionali per l'acquisizione dei patentini professionali per i posatori.



POSA QUALITÀ

THE TRADEMARK

The Posa Qualità Serramenti Trademark identifies the best Italian manufacturers of windows and doors in all materials, offering Italian consumers a tangible way of identifying the best companies with an after-sales warranty on the installed product of up to 10 years.

In this way, the window manufacturer will be able to offer the customer not only a guaranteed "generic" good performance of the window, but real guarantees and, once installed, it will be able to attest the quality of the company and guarantee the products sold over time.

Because guaranteed good installation is the only way offering customers peace of mind.

The Posa Qualità Brands project includes a training plan that will involve the entire window supply chain, a Brand that will certify the quality of the installation by means of strict laboratory tests and guarantee correct installation through spot checks.

The TWIN SYSTEMS Consortium has been certified Posa Qualità Serramenti DESIGN since 2020. The consortium members organise periodic training courses for installers with the award of professional licenses.

MANUALE e CATALOGO PRODOTTI TWIN SYSTEMS POSA QUALITÀ



IL MANUALE e CATALOGO PRODOTTI TWIN SYSTEMS per la POSA QUALITÀ è

- Disponibile presso le sedi dei consorziati e dei serramentisti di riferimento
- Liberamente scaricabile sul sito www.twinsystems.it nella sezione CATALOGHI

The TWIN SYSTEMS MANUAL and PRODUCT CATALOGUE for POSA QUALITÀ

- Is available from consortium members and reference window and door manufacturers
- Free download from the website www.twinsystems.it in the CATALOGUES section

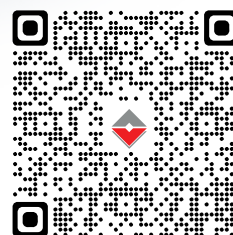

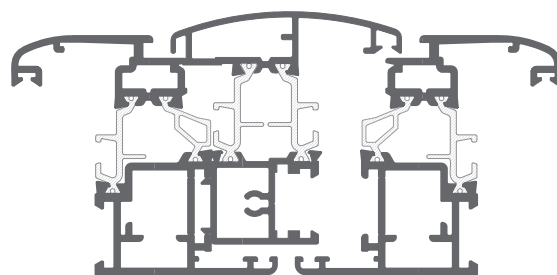
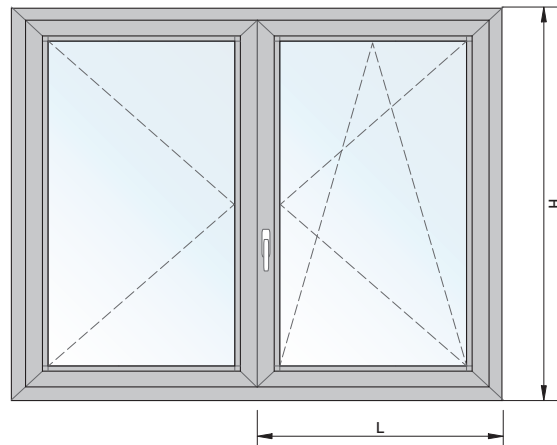
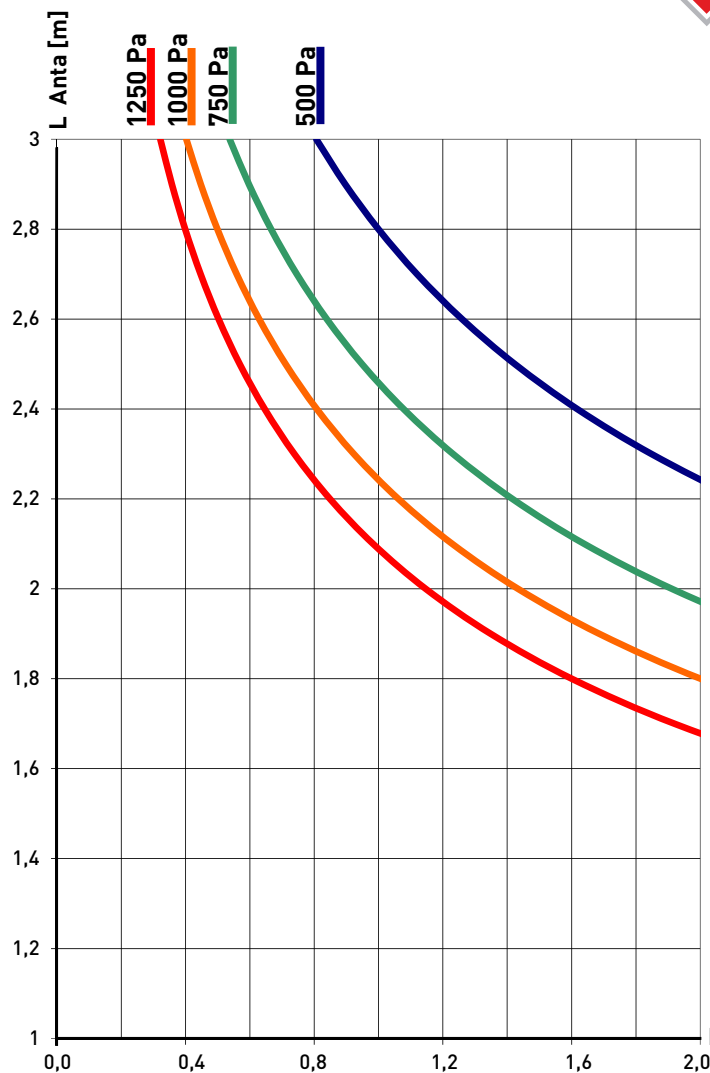

CX55.201 + CX55.301 + CX55.201

**Infisso a 2 ante.
Deflessione del nodo centrale**

Il dimensionamento risultante dal grafico è solo indicativo. Il progettista o il serramentista, nel determinare le dimensioni massime dei serramenti, dovrà considerare e valutare, oltre le dimensioni ed il momento d'inerzia dei profilati, anche le caratteristiche applicative e meteorologiche quali l'altezza dal suolo, l'esposizione alla pioggia e la velocità dei venti nella zona.

Per questi dati consigliamo di consultare e seguire le "Raccomandazioni UNCSAAL" elaborate sulla base delle norme UNI, UNI-EN e UNI-CNR esistenti in merito. Verificare che la freccia del profilato sia compatibile con quella del vetro utilizzato.

Le curve rappresentano la larghezza massima dell'anta in funzione della sua altezza e della pressione del vento. Il serramento è considerato a 2 ante uguali. Le curve sono calcolate sulla base della deformazione elastica di 1/300 dell'altezza del serramento.



ATTENZIONE:
Dimensionamento minimo anta L=430 H=750

**Double sash windows.
Deflection of the central node**

In determining the maximum dimensions of the doors and windows, in addition to the dimensions and moment of inertia of the profiles, the designer or manufacturer must also consider and evaluate the application and meteorological conditions such as the height from the ground, exposure to rain and the speed of the winds in the area.

For these data, we recommend consulting and following the "UNCSAAL Recommendations" drawn up on the basis of the relative UNI, UNI-EN and UNI-CNR standards.

Check that the arrow on the profile is compatible with the arrow on the glass used.

The curves represent the maximum width of the door as a function of its height and wind pressure. The frame is considered to have 2 doors. The curves are calculated on the basis of the elastic deformation of 1/300 of the height of the window.



ATTENZIONE:
Minimum Sash Dimension W=430 H=750

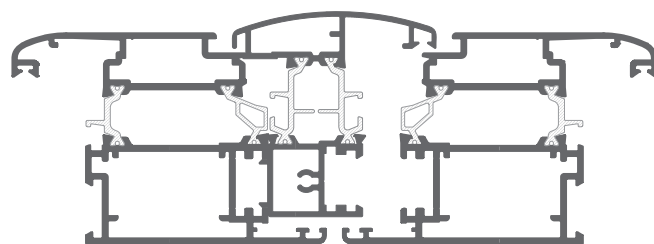
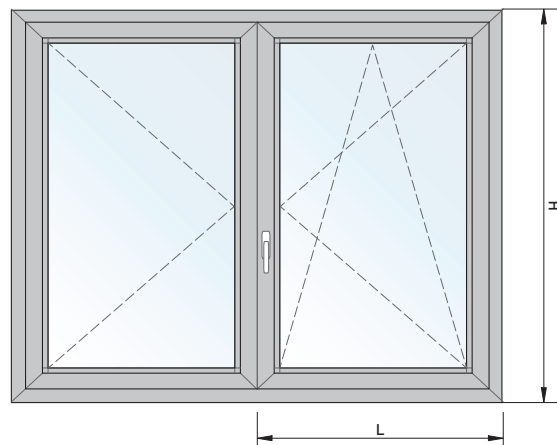
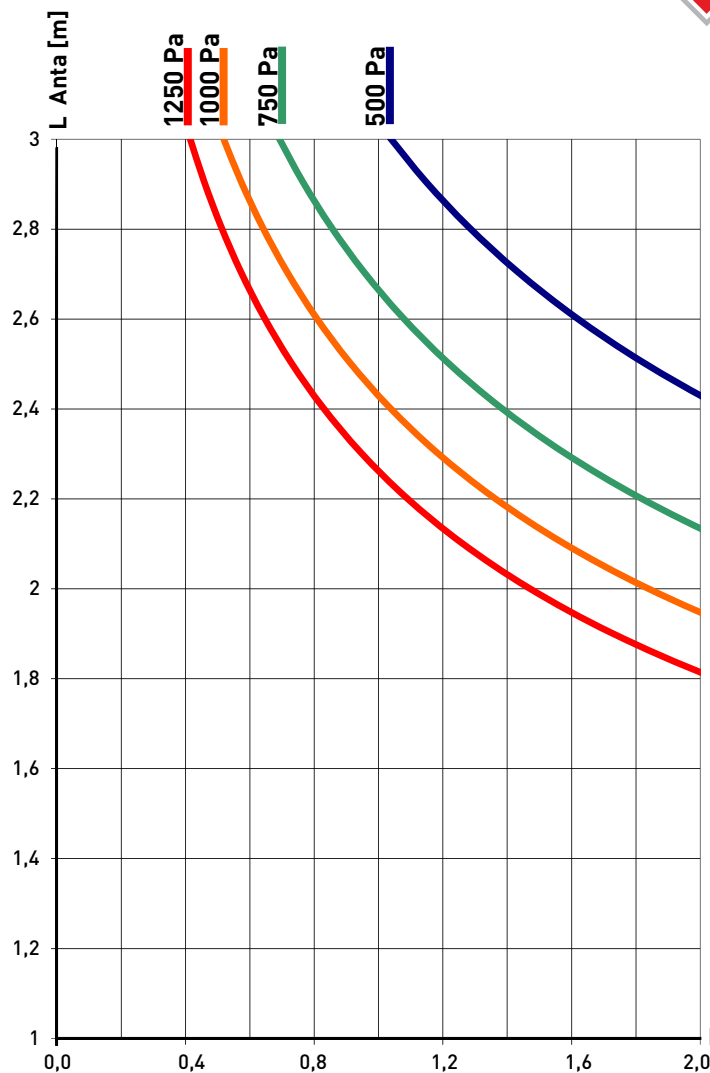

H Anta [m]

CX55.202 + CX55.301 + CX55.202

Infisso a 2 ante.

Deflessione del nodo centrale

Il dimensionamento risultante dal grafico è solo indicativo. Il progettista o il serramentista, nel determinare le dimensioni massime dei serramenti, dovrà considerare e valutare, oltre le dimensioni ed il momento d'inerzia dei profilati, anche le caratteristiche applicative e meteorologiche quali l'altezza dal suolo, l'esposizione alla pioggia e la velocità dei venti nella zona.

Per questi dati consigliamo di consultare e seguire le "Raccomandazioni UNCSAAL" elaborate sulla base delle norme UNI, UNI-EN e UNI-CNR esistenti in merito. Verificare che la freccia del profilato sia compatibile con quella del vetro utilizzato.

Le curve rappresentano la larghezza massima dell'anta in funzione della sua altezza e della pressione del vento. Il serramento è considerato a 2 ante uguali. Le curve sono calcolate sulla base della deformazione elastica di 1/300 dell'altezza del serramento.



ATTENZIONE:

Dimensionamento minimo anta L=430 H=750

Double sash windows.

Deflection of the central node

In determining the maximum dimensions of the doors and windows, in addition to the dimensions and moment of inertia of the profiles, the designer or manufacturer must also consider and evaluate the application and meteorological conditions such as the height from the ground, exposure to rain and the speed of the winds in the area.

For these data, we recommend consulting and following the "UNCSAAL Recommendations" drawn up on the basis of the relative UNI, UNI-EN and UNI-CNR standards.

Check that the arrow on the profile is compatible with the arrow on the glass used.

The curves represent the maximum width of the door as a function of its height and wind pressure.

The frame is considered to have 2 doors.

The curves are calculated on the basis of the elastic deformation of 1/300 of the height of the window.



ATTENZIONE:

Minimum Sash Dimension W=430 H=750



Profili
Profiles

Gruppo B

Elenco Profili
Profili Scala 1:1

Profiles List
Profiles Scale 1:1

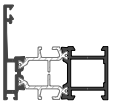
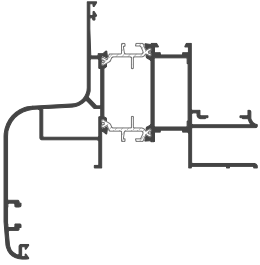
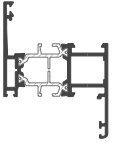
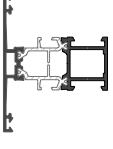
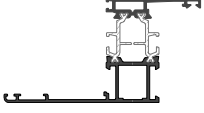
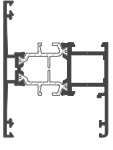
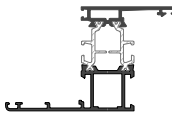
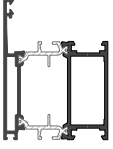
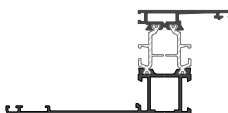
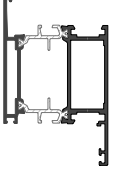
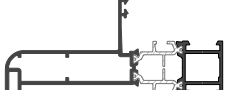
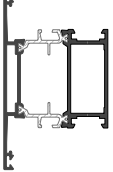
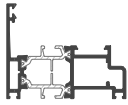
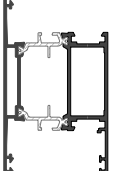
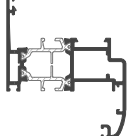

<p>CX55.101</p> <p>Telaio ad L piccolo <i>Small L Frame</i></p> <p>Peso Weight kg/ml 1.074</p> <p>Jx 14.38 cm⁴ Wx 4.76 cm³</p> <p>Jy 5.01 cm⁴ Wy 1.52 cm³</p>	 <p>Tavola Table 9</p>	<p>CX55.109</p> <p>Telaio per capannoni <i>Industrial Sheds Fr.</i></p> <p>Peso Weight kg/ml 2.888</p> <p>Jx 156.32 cm⁴ Wx 20.73 cm³</p> <p>Jy 84.84 cm⁴ Wy 11.69 cm³</p>	 <p>Tavola Table 10</p>
<p>CX55.102</p> <p>Telaio a Z piccolo <i>Small Z Frame</i></p> <p>Peso Weight kg/ml 1.184</p> <p>Jx 14.38 cm⁴ Wx 4.76 cm³</p> <p>Jy 5.01 cm⁴ Wy 1.52 cm³</p>	 <p>Tavola Table 9</p>		
<p>CX55.103</p> <p>Telaio a T piccolo <i>Small T Frame</i></p> <p>Peso Weight kg/ml 1.182</p> <p>Jx 14.38 cm⁴ Wx 4.76 cm³</p> <p>Jy 5.01 cm⁴ Wy 1.52 cm³</p>	 <p>Tavola Table 9</p>	<p>CX55.110</p> <p>Telaio a Z aletta battuta 54 mm. <i>Glazing bead Flap Z-fr. 54 mm.</i></p> <p>Peso Weight kg/ml 1.352</p> <p>Jx 14.38 cm⁴ Wx 4.76 cm³</p> <p>Jy 5.01 cm⁴ Wy 1.52 cm³</p>	 <p>Tavola Table 11</p>
<p>CX55.104</p> <p>Telaio ad H piccolo soglia <i>Low Threshold H Fr.</i></p> <p>Peso Weight kg/ml 1.292</p> <p>Jx 14.38 cm⁴ Wx 4.76 cm³</p> <p>Jy 5.01 cm⁴ Wy 1.52 cm³</p>	 <p>Tavola Table 9</p>	<p>CX55.111</p> <p>Telaio a Z aletta battuta 40 mm. <i>Glazing bead Flap Z-fr. 40 mm.</i></p> <p>Peso Weight kg/ml 1.281</p> <p>Jx 14.38 cm⁴ Wx 4.76 cm³</p> <p>Jy 5.01 cm⁴ Wy 1.52 cm³</p>	 <p>Tavola Table 11</p>
<p>CX55.105</p> <p>Telaio ad L grande <i>Big L Frame</i></p> <p>Peso Weight kg/ml 1.550</p> <p>Jx 14.38 cm⁴ Wx 4.76 cm³</p> <p>Jy 5.01 cm⁴ Wy 1.52 cm³</p>	 <p>Tavola Table 10</p>	<p>CX55.112</p> <p>Telaio a Z aletta battuta 70 mm. <i>Glazing bead Flap Z-fr. 70 mm.</i></p> <p>Peso Weight kg/ml 1.438</p> <p>Jx 14.38 cm⁴ Wx 4.76 cm³</p> <p>Jy 5.01 cm⁴ Wy 1.52 cm³</p>	 <p>Tavola Table 11</p>
<p>CX55.106</p> <p>Telaio a Z grande <i>Big Z Frame</i></p> <p>Peso Weight kg/ml 1.671</p> <p>Jx 14.38 cm⁴ Wx 4.76 cm³</p> <p>Jy 5.01 cm⁴ Wy 1.52 cm³</p>	 <p>Tavola Table 10</p>	<p>CX55.116</p> <p>Semi-pilastrino <i>Semi Pillar</i></p> <p>Peso Weight kg/ml 1.668</p> <p>Jx 14.38 cm⁴ Wx 4.76 cm³</p> <p>Jy 5.01 cm⁴ Wy 1.52 cm³</p>	 <p>Tavola Table 13</p>
<p>CX55.107</p> <p>Telaio ad T grande <i>Big T Frame</i></p> <p>Peso Weight kg/ml 1.667</p> <p>Jx 14.38 cm⁴ Wx 4.76 cm³</p> <p>Jy 5.01 cm⁴ Wy 1.52 cm³</p>	 <p>Tavola Table 10</p>	<p>CX55.119</p> <p>Tel. a L complanare piccolo <i>Small coplanar L-frame</i></p> <p>Peso Weight kg/ml 1.141</p> <p>Jx 14.38 cm⁴ Wx 4.76 cm³</p> <p>Jy 5.01 cm⁴ Wy 1.52 cm³</p>	 <p>Tavola Table 14</p>
<p>CX55.108</p> <p>Telaio ad H grande <i>Big H Frame</i></p> <p>Peso Weight kg/ml 1.788</p> <p>Jx 14.38 cm⁴ Wx 4.76 cm³</p> <p>Jy 5.01 cm⁴ Wy 1.52 cm³</p>	 <p>Tavola Table 10</p>	<p>CX55.120</p> <p>Tel. a Z compl. picc. aletta 25 mm. <i>Small coplanar Z-frame flap 25 mm.</i></p> <p>Peso Weight kg/ml 1.315</p> <p>Jx 14.38 cm⁴ Wx 4.76 cm³</p> <p>Jy 5.01 cm⁴ Wy 1.52 cm³</p>	 <p>Tavola Table 14</p>











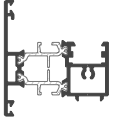
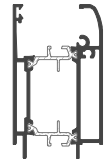
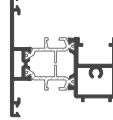
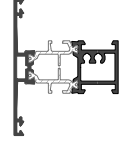
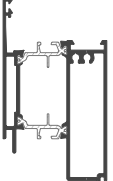

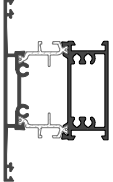

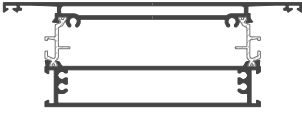
<p>CX55.121</p> <p>Tel. a Z compl. picc. aletta 40 mm. <i>Small coplanar Z-frame flap 40 mm.</i></p> <p>Peso Weight kg/ml 1.403</p> <p>Jx 26.26 cm⁴ Wx 7.64 cm³ Jy 18.94 cm⁴ Wy 3.91 cm³</p>		Tavola Table 14	<p>CX55.172</p> <p>Tel. a Z aletta battuta 32 mm. <i>Glazing bead flap Z-frame 32 mm.</i></p> <p>Peso Weight kg/ml 1.247</p> <p>Jx 18.80 cm⁴ Wx 6.41 cm³ Jy 11.38 cm⁴ Wy 2.58 cm³</p>		Tavola Table 11
<p>CX55.122</p> <p>Telaio / anta piccolo <i>Frame / Small Sash</i></p> <p>Peso Weight kg/ml 1.257</p> <p>Jx 17.47 cm⁴ Wx 6.32 cm³ Jy 8.55 cm⁴ Wy 2.34 cm³</p>		Tavola Table 14	<p>CX55.201</p> <p>Anta tonda Piccola c/fermavetro <i>Small round Sash with glazing bead</i></p> <p>Peso Weight kg/ml 1.351</p> <p>Jx 22.95 cm⁴ Wx 7.09 cm³ Jy 9.92 cm⁴ Wy 2.82 cm³</p>		Tavola Table 16
<p>CX55.123</p> <p>Telaio / anta grande <i>Frame / Large Sash</i></p> <p>Peso Weight kg/ml 1.912</p> <p>Jx 24.75 cm⁴ Wx 8.85 cm³ Jy 28.12 cm⁴ Wy 5.78 cm³</p>		Tavola Table 14	<p>CX55.202</p> <p>Anta tonda Grande c/fermavetro <i>Large round Sash with glazing bead</i></p> <p>Peso Weight kg/ml 1.887</p> <p>Jx 32.09 cm⁴ Wx 10.01 cm³ Jy 30.74 cm⁴ Wy 6.49 cm³</p>		Tavola Table 16
<p>CX55.124</p> <p>Tel. L piccolo Ridotto <i>Small Rounded L. Fr.</i></p> <p>Peso Weight kg/ml 1.046</p> <p>Jx 13.45 cm⁴ Wx 4.60 cm³ Jy 4.75 cm⁴ Wy 1.47 cm³</p>		Tavola Table 12	<p>CX55.203</p> <p>Anta tonda Piccola v/infilare <i>Small round door glass to insert</i></p> <p>Peso Weight kg/ml 1.565</p> <p>Jx 25.75 cm⁴ Wx 7.35 cm³ Jy 15.63 cm⁴ Wy 3.99 cm³</p>		Tavola Table 17
<p>CX55.125</p> <p>Tel. Z piccolo Ridotto <i>Small Rounded Z Fr.</i></p> <p>Peso Weight kg/ml 1.156</p> <p>Jx 16.33 cm⁴ Wx 5.64 cm³ Jy 8.31 cm⁴ Wy 2.22 cm³</p>		Tavola Table 12	<p>CX55.204</p> <p>Anta tonda Piccola f/nastro <i>Small round Sash tape hardware</i></p> <p>Peso Weight kg/ml 1.673</p> <p>Jx 29.399 cm⁴ Wx 9.04 cm³ Jy 15.21 cm⁴ Wy 3.93 cm³</p>		Tavola Table 21
<p>CX55.152</p> <p>Tel. bombato L piccolo <i>Small L Fr. Reduced</i></p> <p>Peso Weight kg/ml 1.221</p> <p>Jx 20.67 cm⁴ Wx 5.84 cm³ Jy 6.82 cm⁴ Wy 2.14 cm³</p>		Tavola Table 15	<p>CX55.205</p> <p>Anta apertura Esterna <i>External opening Sash</i></p> <p>Peso Weight kg/ml 2.147</p> <p>Jx 33.20 cm⁴ Wx 9.06 cm³ Jy 36.35 cm⁴ Wy 7.30 cm³</p>		Tavola Table 26
<p>CX55.153</p> <p>Tel. bombato Z piccolo <i>Small Z. Fr. Reduced</i></p> <p>Peso Weight kg/ml 1.331</p> <p>Jx 42.01 cm⁴ Wx 11.98 cm³ Jy 15.78 cm⁴ Wy 4.61 cm³</p>		Tavola Table 15	<p>CX55.206</p> <p>Anta tonda Grande v/infilare <i>Large round door - glass to insert</i></p> <p>Peso Weight kg/ml 2.037</p> <p>Jx 35.20 cm⁴ Wx 7.09 cm³ Jy 42.73 cm⁴ Wy 8.26 cm³</p>		Tavola Table 17
<p>CX55.163</p> <p>Tel. compensazione <i>Levelling Frame</i></p> <p>Peso Weight kg/ml 1.162</p> <p>Jx 29.12 cm⁴ Wx 8.09 cm³ Jy 11.48 cm⁴ Wy 3.10 cm³</p>		Tavola Table 27	<p>CX55.207</p> <p>Anta apertura Bilico <i>Pivoting Sash</i></p> <p>Peso Weight kg/ml 2.014</p> <p>Jx 33.22 cm⁴ Wx 8.93 cm³ Jy 37.29 cm⁴ Wy 7.32 cm³</p>		Tavola Table 26

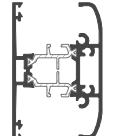

<p>CX55.209</p> <p>Anta piccola ellittica v/infilare <i>Small elliptical door glass to insert</i></p> <p>Peso Weight kg/ml 1.600</p> <p>Jx 27.54 cm⁴ Wx 0.766 cm³</p> <p>Jy 16.14 cm⁴ Wy 04.16 cm³</p>		Tavola Table 17	<p>CX55.233</p> <p>Anta grande ornamentale v/infilare <i>Large ornamental door - glass to insert</i></p> <p>Peso Weight kg/ml 2.102</p> <p>Jx 39.44 cm⁴ Wx 11.06 cm³</p> <p>Jy 45.00 cm⁴ Wy 08.72 cm³</p>		Tavola Table 18
<p>CX55.210</p> <p>Anta grande ellittica v/infilare <i>Large elliptical door glass to insert</i></p> <p>Peso Weight kg/ml 2.704</p> <p>Jx 37.78 cm⁴ Wx 10.78 cm³</p> <p>Jy 43.73 cm⁴ Wy 08.47 cm³</p>		Tavola Table 17	<p>CX55.235</p> <p>Anta dritta rientro 5 mm. <i>Straight Sash recess 5 mm.</i></p> <p>Peso Weight kg/ml 1.315</p> <p>Jx 22.80 cm⁴ Wx 06.95 cm³</p> <p>Jy 08.56 cm⁴ Wy 02.38 cm³</p>		Tavola Table 20
<p>CX55.215</p> <p>Anta dritta piccola c/fermavetro <i>Small straight Sash w/glazing bead</i></p> <p>Peso Weight kg/ml 1.372</p> <p>Jx 23.79 cm⁴ Wx 07.48 cm³</p> <p>Jy 10.77 cm⁴ Wy 03.02 cm³</p>		Tavola Table 19	<p>CX55.237</p> <p>Anta piccola ap. ext. <i>Small ext. op. Sash</i></p> <p>Peso Weight kg/ml 1.611</p> <p>Jx 24.70 cm⁴ Wx 6.63 cm³</p> <p>Jy 13.14 cm⁴ Wy 3.47 cm³</p>		Tavola Table 22
<p>CX55.225</p> <p>Anta tonda grande f/nastro <i>Large round Sash tape hardware</i></p> <p>Peso Weight kg/ml 2.249</p> <p>Jx 42.28 cm⁴ Wx 12.89 cm³</p> <p>Jy 50.34 cm⁴ Wy 9.46 cm³</p>		Tavola Table 22	<p>CX55.238</p> <p>Anta dritta piccola f/nastro <i>Small straight Sash tape hardware</i></p> <p>Peso Weight kg/ml 1.694</p> <p>Jx 30.90 cm⁴ Wx 9.45 cm³</p> <p>Jy 16.27 cm⁴ Wy 4.15 cm³</p>		Tavola Table 22
<p>CX55.226</p> <p>Anta dritta grande c/fermavetro <i>Large straight Sash w/glazing bead</i></p> <p>Peso Weight kg/ml 1.909</p> <p>Jx 33.13 cm⁴ Wx 10.50 cm³</p> <p>Jy 32.29 cm⁴ Wy 06.74 cm³</p>		Tavola Table 19	<p>CX55.262</p> <p>Anta dritta grande f/nastro <i>Large straight Sash tape hardware</i></p> <p>Peso Weight kg/ml 2.271</p> <p>Jx 43.22 cm⁴ Wx 13.03 cm³</p> <p>Jy 52.43 cm⁴ Wy 9.75 cm³</p>		Tavola Table 22
<p>CX55.227</p> <p>Anta doppia battuta grande <i>Large double panelled Sash</i></p> <p>Peso Weight kg/ml 1.896</p> <p>Jx 32.33 cm⁴ Wx 10.14 cm³</p> <p>Jy 31.08 cm⁴ Wy 6.58 cm³</p>		Tavola Table 20	<p>CX55.301</p> <p>Riporto tondo <i>Round wing</i></p> <p>Peso Weight kg/ml 1.309</p> <p>Jx 20.20 cm⁴ Wx 6.16 cm³</p> <p>Jy 7.72 cm⁴ Wy 2.17 cm³</p>		Tavola Table 16
<p>CX55.230</p> <p>Anta tonda f/nastro <i>Round Sash tape hardware</i></p> <p>Peso Weight kg/ml 1.902</p> <p>Jx 34.31 cm⁴ Wx 9.47 cm³</p> <p>Jy 22.66 cm⁴ Wy 5.29 cm³</p>		Tavola Table 21	<p>CX55.302</p> <p>Riporto tondo f/nastro <i>Round wing tape Hardware</i></p> <p>Peso Weight kg/ml 1.372</p> <p>Jx 21.71 cm⁴ Wx 6.65 cm³</p> <p>Jy 8.86 cm⁴ Wy 2.41 cm³</p>		Tavola Table 21
<p>CX55.232</p> <p>Anta picc. ornamentale v/infilare <i>Small ornamental door glass to insert</i></p> <p>Peso Weight kg/ml 1.615</p> <p>Jx 28.48 cm⁴ Wx 07.82 cm³</p> <p>Jy 16.55 cm⁴ Wy 04.26 cm³</p>		Tavola Table 18	<p>CX55.303</p> <p>Riporto/inversione bilico <i>Wing/reverse pivoting</i></p> <p>Peso Weight kg/ml 1.214</p> <p>Jx 15.59 cm⁴ Wx 4.16 cm³</p> <p>Jy 7.07 cm⁴ Wy 2.17 cm³</p>		Tavola Table 28

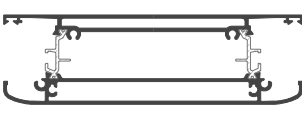

<p>CX55.304</p> <p>Riporto dritto <i>Straight wing</i></p> <p>Peso Weight kg/ml 1.228</p> <p>Jx 17.00 cm⁴ Wx 05.57 cm³</p> <p>Jy 06.90 cm⁴ Wy 01.97 cm³</p>		<p>Tavola Table 16</p>	<p>CX55.407</p> <p>Soprazzoccolo v/infilare 74 mm. <i>Over Sill glass to insert 74 mm.</i></p> <p>Peso Weight kg/ml 1.666</p> <p>Jx 19.24 cm⁴ Wx 8.08 cm³</p> <p>Jy 27.79 cm⁴ Wy 6.63 cm³</p>		<p>Tavola Table 23</p>
<p>CX55.308</p> <p>Riporto dritto f/nastro <i>Straight wing tape Hardware</i></p> <p>Peso Weight kg/ml 1.319</p> <p>Jx 19.09 cm⁴ Wx 6.15 cm³</p> <p>Jy 8.11 cm⁴ Wy 2.25 cm³</p>		<p>Tavola Table 21</p>	<p>CX55.408</p> <p>Traverso piccolo 72 mm. <i>Small Crosspiece 72 mm.</i></p> <p>Peso Weight kg/ml 1.270</p> <p>Jx 17.69 cm⁴ Wx 5.67 cm³</p> <p>Jy 8.53 cm⁴ Wy 2.34 cm³</p>		<p>Tavola Table 28</p>
<p>CX55.401</p> <p>Soprazzoccolo <i>Over Sill</i></p> <p>Peso Weight kg/ml 1.803</p> <p>Jx 26.39 cm⁴ Wx 9.50 cm³</p> <p>Jy 37.17 cm⁴ Wy 7.31 cm³</p>		<p>Tavola Table 24</p>	<p>CX55.409</p> <p>Soglia bassa <i>Low Threshold</i></p> <p>Peso Weight kg/ml 0.942</p> <p>Jx 9.58 cm⁴ Wx 3.44 cm³</p> <p>Jy 8.39 cm⁴ Wy 10.51 cm³</p>		<p>Tavola Table 12</p>
<p>CX55.402</p> <p>Traverso 96 mm. <i>Crosspiece 96 mm.</i></p> <p>Peso Weight kg/ml 1.906</p> <p>Jx 26.25 cm⁴ Wx 8.56 cm³</p> <p>Jy 27.99 cm⁴ Wy 5.81 cm³</p>		<p>Tavola Table 24</p>	<p>CX55.414</p> <p>Soglia bassa per porte <i>Door Low Threshold</i></p> <p>Peso Weight kg/ml 0.747</p> <p>Jx 6.57 cm⁴ Wx 2.30 cm³</p> <p>Jy 0.61 cm⁴ Wy 00.68 cm³</p>		<p>Tavola Table 25</p>
<p>CX55.403</p> <p>Fascia 158 mm. <i>Band 158 mm.</i></p> <p>Peso Weight kg/ml 2.978</p> <p>Jx 48.01 cm⁴ Wx 15.67 cm³</p> <p>Jy 179.67 cm⁴ Wy 22.74 cm³</p>		<p>Tavola Table 25</p>	<p>CX55.415</p> <p>Fascia compl. da 78x158 mm. <i>Complementary Sash 78x158 mm.</i></p> <p>Peso Weight kg/ml 3.076</p> <p>Jx 62.91 cm⁴ Wx 18.73 cm³</p> <p>Jy 185.49 cm⁴ Wy 23.47 cm³</p>		<p>Tavola Table 20</p>
<p>CX55.404</p> <p>Zoccolo 158 mm. <i>Sill 158 mm.</i></p> <p>Peso Weight kg/ml 3.195</p> <p>Jx 51.27 cm⁴ Wx 17.30 cm³</p> <p>Jy 198.61 cm⁴ Wy 24.40 cm³</p>		<p>Tavola Table 25</p>	<p>CX70.521</p> <p>Fermavetro tondo 14 mm. <i>Round glazing bead 14 mm.</i></p> <p>Peso Weight kg/ml 0.266</p> <p>Jx 00.00 cm⁴ Wx 00.00 cm³</p> <p>Jy 00.00 cm⁴ Wy 00.00 cm³</p>		<p>Tavola Table 35</p>
<p>CX55.405</p> <p>Traverso v/infilare 72 mm. <i>Crosspiece glass to insert 72 mm.</i></p> <p>Peso Weight kg/ml 1.504</p> <p>Jx 17.48 cm⁴ Wx 6.77 cm³</p> <p>Jy 16.94 cm⁴ Wy 4.70 cm³</p>		<p>Tavola Table 23</p>	<p>CX70.522</p> <p>Fermavetro tondo 18 mm. <i>Round glazing bead 18 mm.</i></p> <p>Peso Weight kg/ml 0.277</p> <p>Jx 00.00 cm⁴ Wx 00.00 cm³</p> <p>Jy 00.00 cm⁴ Wy 00.00 cm³</p>		<p>Tavola Table 35</p>
<p>CX55.406</p> <p>Traverso v/infilare 158 mm. <i>Crosspiece glass to insert 158 mm.</i></p> <p>Peso Weight kg/ml 3.123</p> <p>Jx 39.09 cm⁴ Wx 16.12 cm³</p> <p>Jy 218.96 cm⁴ Wy 27.71 cm³</p>		<p>Tavola Table 23</p>	<p>CX70.523</p> <p>Fermavetro tondo 22 mm. <i>Round glazing bead 22 mm.</i></p> <p>Peso Weight kg/ml 0.294</p> <p>Jx 00.00 cm⁴ Wx 00.00 cm³</p> <p>Jy 00.00 cm⁴ Wy 00.00 cm³</p>		<p>Tavola Table 35</p>











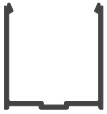

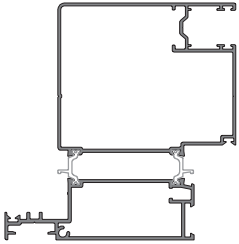

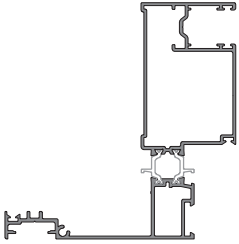
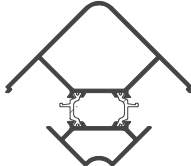
<p>CX70.524</p> <p>Fermavetro tondo 26 mm. <i>Round glazing bead 26 mm.</i></p> <p>Peso Weight kg/ml 0.314</p> <p>Jx 00.00 cm⁴ Wx 00.00 cm³</p> <p>Jy 00.00 cm⁴ Wy 00.00 cm³</p>		Tavola Table 35	<p>CX70.532</p> <p>Fermavetro dritto 35 mm. <i>Straight glazing bead 35 mm.</i></p> <p>Peso Weight kg/ml 0.383</p> <p>Jx 00.00 cm⁴ Wx 00.00 cm³</p> <p>Jy 00.00 cm⁴ Wy 00.00 cm³</p>		Tavola Table 36
<p>CX70.525</p> <p>Fermavetro tondo 30 mm. <i>Round glazing bead 30 mm.</i></p> <p>Peso Weight kg/ml 0.350</p> <p>Jx 00.00 cm⁴ Wx 00.00 cm³</p> <p>Jy 00.00 cm⁴ Wy 00.00 cm³</p>		Tavola Table 35	<p>CX70.533</p> <p>Fermavetro dritto 5 mm. <i>Straight glazing bead 5 mm.</i></p> <p>Peso Weight kg/ml 0.252</p> <p>Jx 00.00 cm⁴ Wx 00.00 cm³</p> <p>Jy 00.00 cm⁴ Wy 00.00 cm³</p>		Tavola Table 36
<p>CX70.526</p> <p>Fermavetro dritto 14 mm. <i>Straight glazing bead 14 mm.</i></p> <p>Peso Weight kg/ml 0.279</p> <p>Jx 00.00 cm⁴ Wx 00.00 cm³</p> <p>Jy 00.00 cm⁴ Wy 00.00 cm³</p>		Tavola Table 36	<p>CX70.537</p> <p>Fermavetro dritto 40 mm. <i>Straight glazing bead 40 mm.</i></p> <p>Peso Weight kg/ml 0.403</p> <p>Jx 00.00 cm⁴ Wx 00.00 cm³</p> <p>Jy 00.00 cm⁴ Wy 00.00 cm³</p>		Tavola Table 36
<p>CX70.527</p> <p>Fermavetro dritto 18 mm. <i>Straight glazing bead 18 mm.</i></p> <p>Peso Weight kg/ml 0.290</p> <p>Jx 00.00 cm⁴ Wx 00.00 cm³</p> <p>Jy 00.00 cm⁴ Wy 00.00 cm³</p>		Tavola Table 36	<p>CX70.539</p> <p>Fermavetro dritto 10 mm. <i>Straight glazing bead 10 mm.</i></p> <p>Peso Weight kg/ml 0.245</p> <p>Jx 00.00 cm⁴ Wx 00.00 cm³</p> <p>Jy 00.00 cm⁴ Wy 00.00 cm³</p>		Tavola Table 36
<p>CX70.528</p> <p>Fermavetro dritto 22 mm. <i>Straight glazing bead 22 mm.</i></p> <p>Peso Weight kg/ml 0.307</p> <p>Jx 00.00 cm⁴ Wx 00.00 cm³</p> <p>Jy 00.00 cm⁴ Wy 00.00 cm³</p>		Tavola Table 36	<p>CX70.562</p> <p>Fermavetro Sicurezza 14 mm. <i>Safety glazing bead 14 mm.</i></p> <p>Peso Weight kg/ml 0.309</p> <p>Jx 00.00 cm⁴ Wx 00.00 cm³</p> <p>Jy 00.00 cm⁴ Wy 00.00 cm³</p>		Tavola Table 38
<p>CX70.529</p> <p>Fermavetro dritto 26 mm. <i>Straight glazing bead 26 mm.</i></p> <p>Peso Weight kg/ml 0.327</p> <p>Jx 00.00 cm⁴ Wx 00.00 cm³</p> <p>Jy 00.00 cm⁴ Wy 00.00 cm³</p>		Tavola Table 36	<p>CX70.563</p> <p>Fermavetro Sicurezza 18 mm. <i>Safety glazing bead 18 mm.</i></p> <p>Peso Weight kg/ml 0.330</p> <p>Jx 00.00 cm⁴ Wx 00.00 cm³</p> <p>Jy 00.00 cm⁴ Wy 00.00 cm³</p>		Tavola Table 38
<p>CX70.530</p> <p>Fermavetro dritto 30 mm. <i>Straight glazing bead 30 mm.</i></p> <p>Peso Weight kg/ml 0.362</p> <p>Jx 00.00 cm⁴ Wx 00.00 cm³</p> <p>Jy 00.00 cm⁴ Wy 00.00 cm³</p>		Tavola Table 36	<p>CX70.564</p> <p>Fermavetro Sicurezza 22 mm. <i>Safety glazing bead 22 mm.</i></p> <p>Peso Weight kg/ml 0.348</p> <p>Jx 00.00 cm⁴ Wx 00.00 cm³</p> <p>Jy 00.00 cm⁴ Wy 00.00 cm³</p>		Tavola Table 38
<p>CX70.531</p> <p>Fermavetro tondo 35 mm. <i>Round glazing bead 35 mm.</i></p> <p>Peso Weight kg/ml 0.370</p> <p>Jx 00.00 cm⁴ Wx 00.00 cm³</p> <p>Jy 00.00 cm⁴ Wy 00.00 cm³</p>		Tavola Table 35	<p>CX70.565</p> <p>Fermavetro Sicurezza 26 mm. <i>Safety glazing bead 26 mm.</i></p> <p>Peso Weight kg/ml 0.372</p> <p>Jx 00.00 cm⁴ Wx 00.00 cm³</p> <p>Jy 00.00 cm⁴ Wy 00.00 cm³</p>		Tavola Table 38

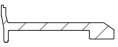

<p>CX70.566</p> <p>Fermavetro Sicurezza 30 mm. Safety glazing bead 30 mm.</p> <p>Peso Weight kg/ml 0.400</p> <p>Jx 00.00 cm⁴ Wx 00.00 cm³</p> <p>Jy 00.00 cm⁴ Wy 00.00 cm³</p>		Tavola Table 38	<p>CX70.581</p> <p>Fermavetro Clips Tondo 35 mm. Round glazing bead Clips 35 mm.</p> <p>Peso Weight kg/ml 0.361</p> <p>Jx 00.00 cm⁴ Wx 00.00 cm³</p> <p>Jy 00.00 cm⁴ Wy 00.00 cm³</p>		Tavola Table 37
<p>CX70.567</p> <p>Fermavetro Sicurezza 35 mm. Safety glazing bead 35 mm.</p> <p>Peso Weight kg/ml 0.437</p> <p>Jx 00.00 cm⁴ Wx 00.00 cm³</p> <p>Jy 00.00 cm⁴ Wy 00.00 cm³</p>		Tavola Table 38	<p>XX70.601</p> <p>Gocciolatoio Drip Tray</p> <p>Peso Weight kg/ml 0.269</p> <p>Jx 00.00 cm⁴ Wx 00.00 cm³</p> <p>Jy 00.00 cm⁴ Wy 00.00 cm³</p>		Tavola Table 24
<p>CX70.568</p> <p>Fermavetro Sicurezza 10 mm. Safety glazing bead 10 mm.</p> <p>Peso Weight kg/ml 0.273</p> <p>Jx 00.00 cm⁴ Wx 00.00 cm³</p> <p>Jy 00.00 cm⁴ Wy 00.00 cm³</p>		Tavola Table 38	<p>XX70.603</p> <p>Soglia piana Flat Threshold</p> <p>Peso Weight kg/ml 0.275</p> <p>Jx 00.00 cm⁴ Wx 00.00 cm³</p> <p>Jy 00.00 cm⁴ Wy 00.00 cm³</p>		Tavola Table 24
<p>CX70.571</p> <p>Fermavetro Clips Tondo 14 mm. Round glazing bead Clips 14 mm.</p> <p>Peso Weight kg/ml 0.216</p> <p>Jx 00.00 cm⁴ Wx 00.00 cm³</p> <p>Jy 00.00 cm⁴ Wy 00.00 cm³</p>		Tavola Table 37	<p>CX55.604</p> <p>Inversione di Battuta Rabbet Reversal</p> <p>Peso Weight kg/ml 1.132</p> <p>Jx 11.44 cm⁴ Wx 3.43 cm³</p> <p>Jy 4.38 cm⁴ Wy 1.38 cm³</p>		Tavola Table 28
<p>CX70.572</p> <p>Fermavetro Clips Tondo 18 mm. Round glazing bead Clips 18 mm.</p> <p>Peso Weight kg/ml 0.274</p> <p>Jx 00.00 cm⁴ Wx 00.00 cm³</p> <p>Jy 00.00 cm⁴ Wy 00.00 cm³</p>		Tavola Table 37	<p>CX70.605</p> <p>Astina Bar</p> <p>Peso Weight kg/ml 0.146</p> <p>Jx 00.00 cm⁴ Wx 00.00 cm³</p> <p>Jy 00.00 cm⁴ Wy 00.00 cm³</p>		Tavola Table 19
<p>CX70.573</p> <p>Fermavetro Clips Tondo 22 mm. Round glazing bead Clips 22 mm.</p> <p>Peso Weight kg/ml 0.299</p> <p>Jx 00.00 cm⁴ Wx 00.00 cm³</p> <p>Jy 00.00 cm⁴ Wy 00.00 cm³</p>		Tavola Table 37	<p>XX70.606</p> <p>Scivolo Esterno Soglia Bassa Bottom threshold external slide</p> <p>Peso Weight kg/ml 0.322</p> <p>Jx 00.00 cm⁴ Wx 00.00 cm³</p> <p>Jy 00.00 cm⁴ Wy 00.00 cm³</p>		Tavola Table 12
<p>CX70.574</p> <p>Fermavetro Clips Tondo 26 mm. Round glazing bead Clips 26 mm.</p> <p>Peso Weight kg/ml 0.329</p> <p>Jx 00.00 cm⁴ Wx 00.00 cm³</p> <p>Jy 00.00 cm⁴ Wy 00.00 cm³</p>		Tavola Table 37	<p>CX55.607</p> <p>Scivolo Interno Soglia Bassa Bottom threshold internal slide</p> <p>Peso Weight kg/ml 0.170</p> <p>Jx 00.00 cm⁴ Wx 00.00 cm³</p> <p>Jy 00.00 cm⁴ Wy 00.00 cm³</p>		Tavola Table 12
<p>CX70.575</p> <p>Fermavetro Clips Tondo 30 mm. Round glazing bead Clips 30 mm.</p> <p>Peso Weight kg/ml 0.353</p> <p>Jx 00.00 cm⁴ Wx 00.00 cm³</p> <p>Jy 00.00 cm⁴ Wy 00.00 cm³</p>		Tavola Table 37	<p>RX70.609</p> <p>Chiusura Rinforzo Montanti Uprights reinforcement closure depth</p> <p>Peso Weight kg/ml 0.393</p> <p>Jx 0.10 cm⁴ Wx 0.11 cm³</p> <p>Jy 3.99 cm⁴ Wy 1.53 cm³</p>		Tavola Table 13





<p>RX70.610</p> <p>Rinforzo Montanti <i>Uprights reinforcement</i></p> <p>Peso Weight kg/ml 0.994</p> <p>Jx 14.38 cm⁴ Wx 4.76 cm³</p> <p>Jy 5.01 cm⁴ Wy 1.52 cm³</p>		<p>Tavola Table 13</p>	<p>XX70.643</p> <p>Porta Spazzolino Anta <i>Sash Brush Holder</i></p> <p>Peso Weight kg/ml 0.264</p> <p>Jx 00.00 cm⁴ Wx 00.00 cm³</p> <p>Jy 00.00 cm⁴ Wy 00.00 cm³</p>		<p>Tavola Table 13</p>
<p>XX70.611</p> <p>Profilo per squadretta <i>Corner Joint Profile</i></p> <p>Peso Weight kg/ml 3.476</p> <p>Jx 00.00 cm⁴ Wx 00.00 cm³</p> <p>Jy 00.00 cm⁴ Wy 00.00 cm³</p>		<p>Tavola Table 24</p>	<p>CX55.701</p> <p>Spalla laterale chiusa <i>Closed Side Reveal</i></p> <p>Peso Weight kg/ml 3.106</p> <p>Jx 203.13 cm⁴ Wx 29.65 cm³</p> <p>Jy 129.18 cm⁴ Wy 19.16 cm³</p>		<p>Tavola Table 29</p>
<p>XX70.612</p> <p>Profilo bancalino <i>Pallet profile</i></p> <p>Peso Weight kg/ml 0.254</p> <p>Jx 00.00 cm⁴ Wx 00.00 cm³</p> <p>Jy 00.00 cm⁴ Wy 00.00 cm³</p>		<p>Tavola Table 12</p>	<p>CX55.702</p> <p>Spalla laterale aperta <i>Open Side Reveal</i></p> <p>Peso Weight kg/ml 2.538</p> <p>167.98 cm⁴ 27.02 cm³</p> <p>87.13 cm⁴ 10.95 cm³</p>		<p>Tavola Table 29</p>
<p>XX70.613</p> <p>Angolo universale <i>Universal Corner profile</i></p> <p>Peso Weight kg/ml 1.861</p> <p>Jx 00.00 cm⁴ Wx 00.00 cm³</p> <p>Jy 00.00 cm⁴ Wy 00.00 cm³</p>		<p>Tavola Table 27</p>			
<p>CX55.627</p> <p>Battuta riportata per zoccolo <i>Added rabbet for sill</i></p> <p>Peso Weight kg/ml 0.622</p> <p>Jx 7.36 cm⁴ Wx 2.40 cm³</p> <p>Jy 7.16 cm⁴ Wy 3.94 cm³</p>		<p>Tavola Table 25</p>	<p>XX70.503</p> <p>Coprifilo <i>Casing Profile</i></p> <p>Peso Weight kg/ml 0.224</p> <p>Jx 00.00 cm⁴ Wx 00.00 cm³</p> <p>Jy 00.00 cm⁴ Wy 00.00 cm³</p>		<p>Tavola Table 24</p>
<p>XX60.635</p> <p>Battuta riportata per telaio <i>Added rabbet for frame</i></p> <p>Peso Weight kg/ml 0.306</p> <p>Jx 00.00 cm⁴ Wx 00.00 cm³</p> <p>Jy 00.00 cm⁴ Wy 00.00 cm³</p>		<p>Tavola Table 12</p>	<p>XX70.504</p> <p>Coprifilo <i>Casing Profile</i></p> <p>Peso Weight kg/ml 0.238</p> <p>Jx 00.00 cm⁴ Wx 00.00 cm³</p> <p>Jy 00.00 cm⁴ Wy 00.00 cm³</p>		<p>Tavola Table 24</p>
<p>CX55.640</p> <p>Profilo Sostegno Inversione <i>Support Profile Reversal</i></p> <p>Peso Weight kg/ml 0.861</p> <p>Jx 00.00 cm⁴ Wx 00.00 cm³</p> <p>Jy 00.00 cm⁴ Wy 00.00 cm³</p>		<p>Tavola Table 28</p>	<p>XX70.703</p> <p>Traverso Superiore Monoblocco <i>Upper Monobloc Crosspiece</i></p> <p>Peso Weight kg/ml 0.832</p> <p>Jx 00.00 cm⁴ Wx 00.00 cm³</p> <p>Jy 00.00 cm⁴ Wy 00.00 cm³</p>		<p>Tavola Table 30</p>
<p>XX70.2040</p> <p>Gocciolatoio Minil <i>Mini Drip Tray</i></p> <p>Peso Weight kg/ml 0.095</p> <p>Jx 00.00 cm⁴ Wx 00.00 cm³</p> <p>Jy 00.00 cm⁴ Wy 00.00 cm³</p>		<p>Tavola Table 19</p>	<p>XX70.704</p> <p>Coprivite <i>Screw Cover</i></p> <p>Peso Weight kg/ml 0.135</p> <p>Jx 00.00 cm⁴ Wx 00.00 cm³</p> <p>Jy 00.00 cm⁴ Wy 00.00 cm³</p>		<p>Tavola Table 30</p>



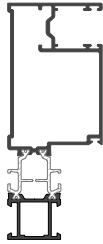

XX70.705			Tavola Table 30
Profilo battuta cassonetto <i>Shutter box rabbet profile</i>			
Peso Weight	kg/ml 0.155		
Jx 00.00 cm ⁴	Wx 00.00 cm ³		
Jy 00.00 cm ⁴	Wy 00.00 cm ³		

CX55.706			Tavola Table 30
Mezza spalla monoblocco <i>Monobloc Half Reveal</i>			
Peso Weight	kg/ml 1.984		
Jx 117.11 cm ⁴	Wx 17.59 cm ³		
Jy 18.60 cm ⁴	Wy 6.48 cm ³		

XX70.801			Tavola Table 33
Imbotte da 120 mm. <i>Jamb 120 mm.</i>			
Peso Weight	kg/ml 1.321		
Jx 76.93 cm ⁴	Wx 9.91 cm ³		
Jy 20.54 cm ⁴	Wy 4.10 cm ³		

XX70.802			Tavola Table 33
Prolunga Imbotte 90 mm. <i>90 mm. Jamb Extension</i>			
Peso Weight	kg/ml 0.882		
Jx 00.00 cm ⁴	Wx 00.00 cm ³		
Jy 00.00 cm ⁴	Wy 00.00 cm ³		

XX70.803			Tavola Table 33
Prolunga Imbotte 50 mm. <i>50 mm. Jamb Extension</i>			
Peso Weight	kg/ml 0.574		
Jx 00.00 cm ⁴	Wx 00.00 cm ³		
Jy 00.00 cm ⁴	Wy 00.00 cm ³		

XX70.808			Tavola Table 33
Jolly per Imbotte <i>Jolly for Jamb</i>			
Peso Weight	kg/ml 0.750		
Jx 00.00 cm ⁴	Wx 00.00 cm ³		
Jy 00.00 cm ⁴	Wy 00.00 cm ³		

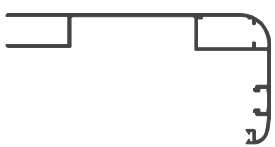
XX70.809			Tavola Table 33
Imbotte 140 mm. <i>Jamb 140 mm.</i>			
Peso Weight	kg/ml 1.500		
Jx 123.04 cm ⁴	Wx 13.89 cm ³		
Jy 22.31 cm ⁴	Wy 4.30 cm ³		

CX45.3362			Tavola Table 31
Centrale per Cassonetto <i>Central Shutter Box</i>			
Peso Weight	kg/ml 1.153		
Jx 00.00 cm ⁴	Wx 00.00 cm ³		
Jy 00.00 cm ⁴	Wy 00.00 cm ³		

CX45.3363			Tavola Table 31
Super./Infer. Cassonetto <i>Upper/Lower Shutter Box</i>			
Peso Weight	kg/ml 1.385		
Jx 00.00 cm ⁴	Wx 00.00 cm ³		
Jy 00.00 cm ⁴	Wy 00.00 cm ³		

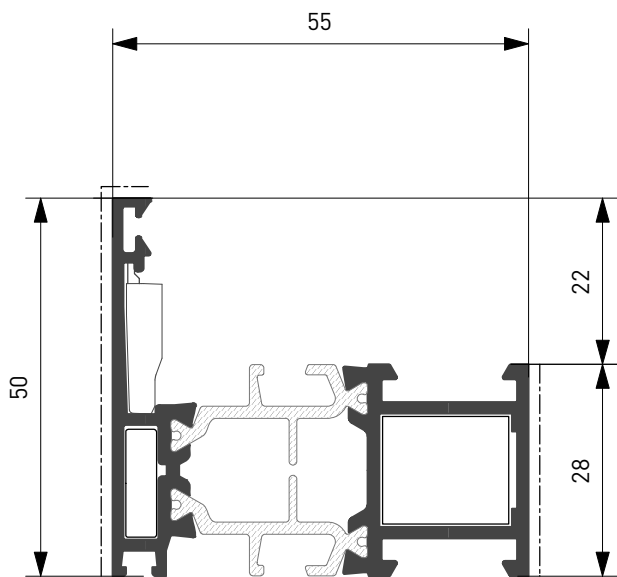

CX55.101

Kg/ml 1.077
--- mm. 78,0

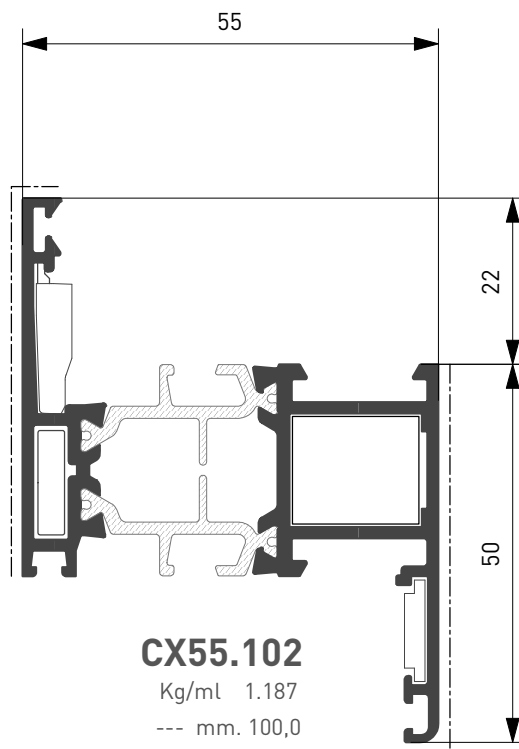

CX55.102

Kg/ml 1.187
--- mm. 100,0

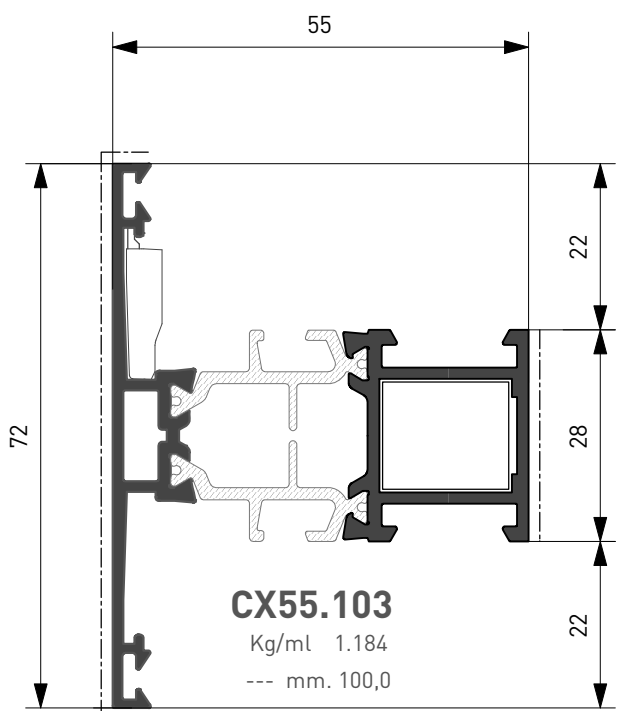

CX55.103

Kg/ml 1.184
--- mm. 100,0

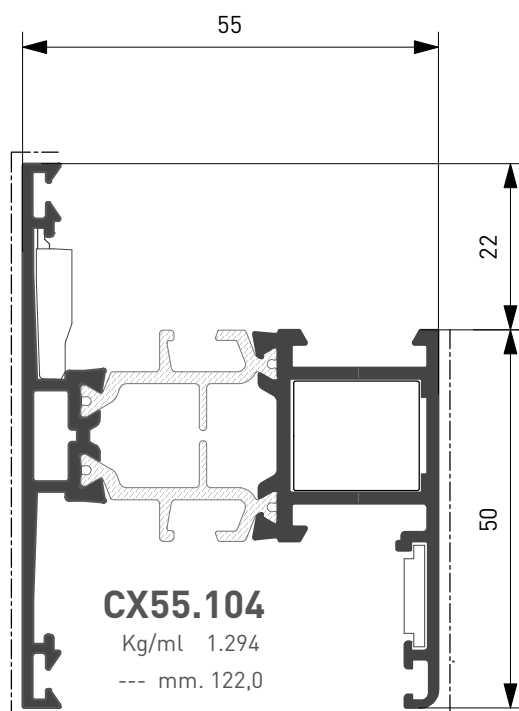

CX55.104

Kg/ml 1.294
--- mm. 122,0

Profilato Profile	Squadretta esterna External Corner Joint		Squadretta interna Internal Corner Joint				Sq. Allineamento Alining Corner J.	
	Cianfrinare Riveting	Spinare Crimping	Bottone Slot	Cianfrinare Riveting	Spinare Crimping	Avvitare Screw	Esterna External	Interna Internal
CX55.101	ARX.03.SQ	ARX.03.SQ + ARX.08.SQ	AWX.16.SQ		AWX.19.SQ		ARX.15.SQ	
CX55.102	ARX.03.SQ	ARX.03.SQ + ARX.08.SQ	AWX.16.SQ		AWX.19.SQ		ARX.15.SQ	ARX.10.SQ
CX55.103			AWX.16.SQ		AWX.19.SQ		ARX.15.SQ	
CX55.104			AWX.16.SQ		AWX.19.SQ		ARX.15.SQ	ARX.10.SQ

ATTENZIONE! per spinatura aggiungere anche LM0088 | Per avvitatura aggiungere anche VILM 5x14_D8
ATTENTION! For crimping add LM0088 | For screw add VILM 5x14_D8

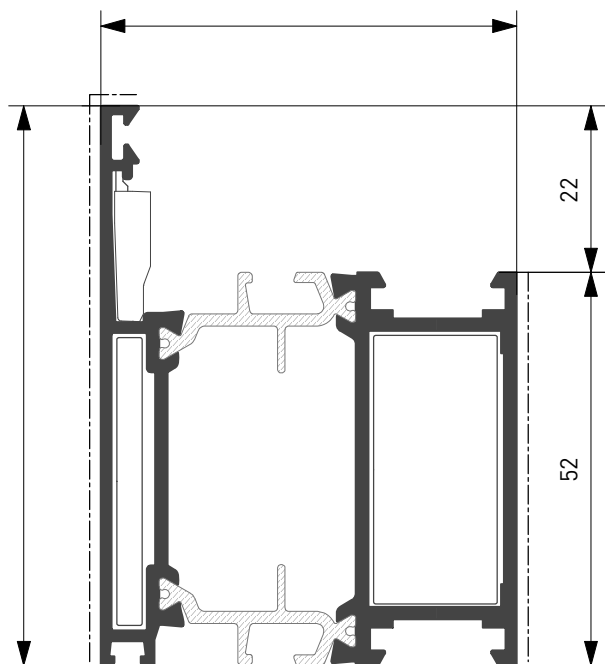

CX55.105

Kg/ml 1.522
--- mm. 126,0

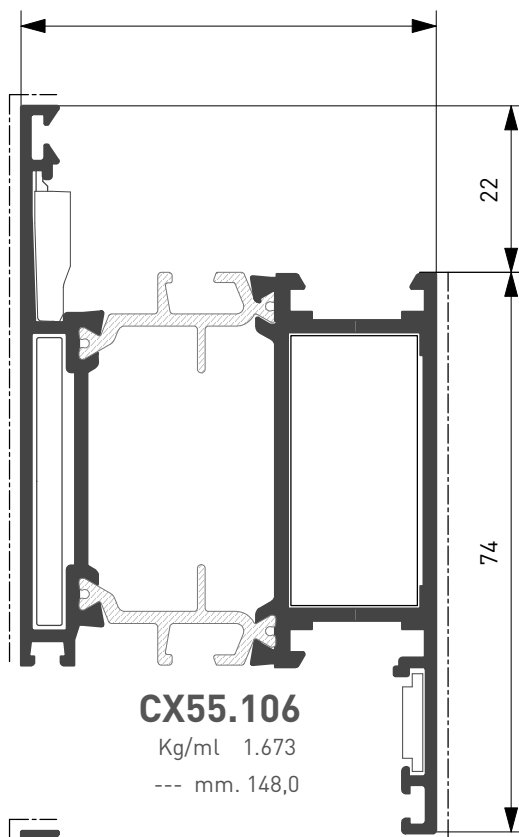

CX55.106

Kg/ml 1.673
--- mm. 148,0

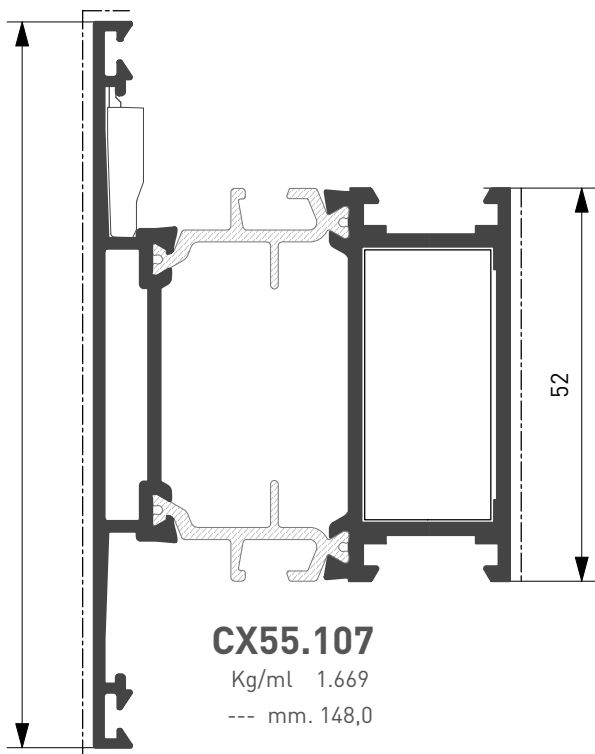

CX55.107

Kg/ml 1.669
--- mm. 148,0

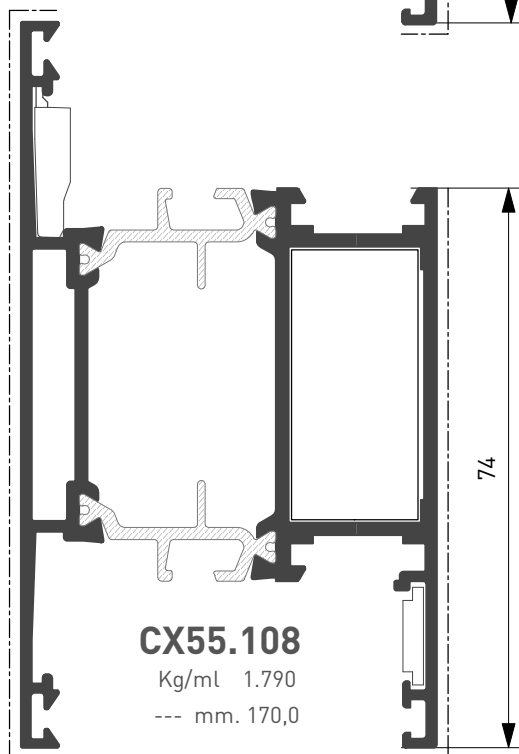

CX55.108

Kg/ml 1.790
--- mm. 170,0

Profilato Profile	Squadretta esterna External Corner Joint		Squadretta interna Internal Corner Joint				Sq. Allineamento Alining Corner J.	
	Cianfrinare Riveting	Spinare Crimping	Bottone Slot	Cianfrinare Riveting	Spinare Crimping	Avvitare Screw	Esterna External	Interna Internal
CX55.105	ARX.06.SQ	ARX.06.SQ + ARX.08.SQ			AWX.17.SQ		ARX.15.SQ	
CX55.106	ARX.06.SQ	ARX.06.SQ + ARX.08.SQ			AWX.17.SQ		ARX.15.SQ	ARX.10.SQ
CX55.107					AWX.17.SQ		ARX.15.SQ	
CX55.108					AWX.17.SQ		ARX.15.SQ	ARX.10.SQ

ATTENZIONE! per spinatura aggiungere anche LM0088 | Per avvitatura aggiungere anche VILM 5x14_D8
ATTENTION! For crimping add LM0088 | For screw add VILM 5x14_D8

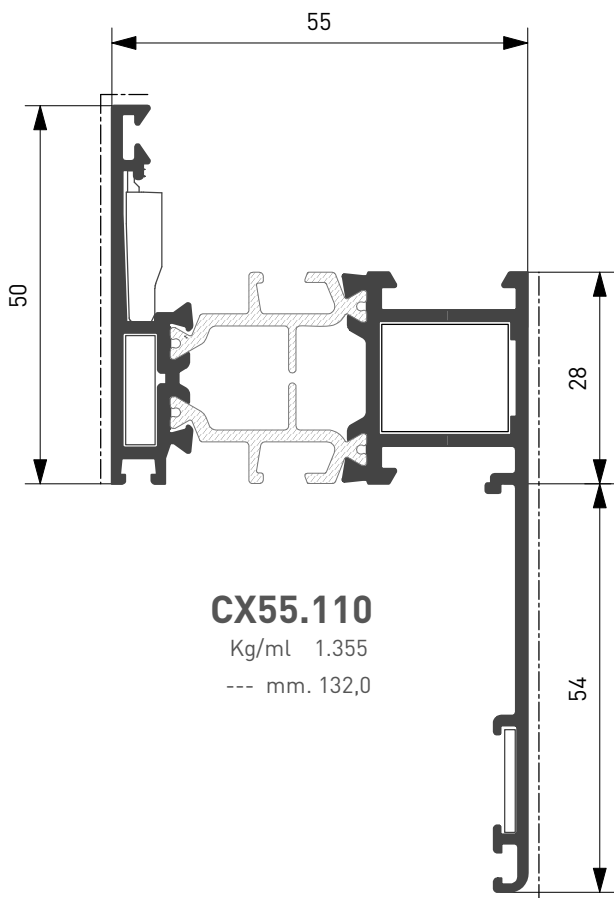

CX55.110

Kg/ml 1.355
--- mm. 132,0

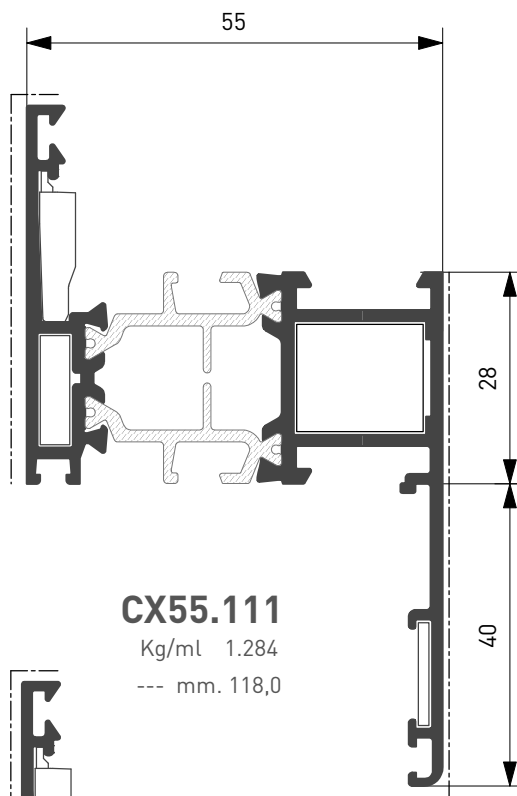

CX55.111

Kg/ml 1.284
--- mm. 118,0

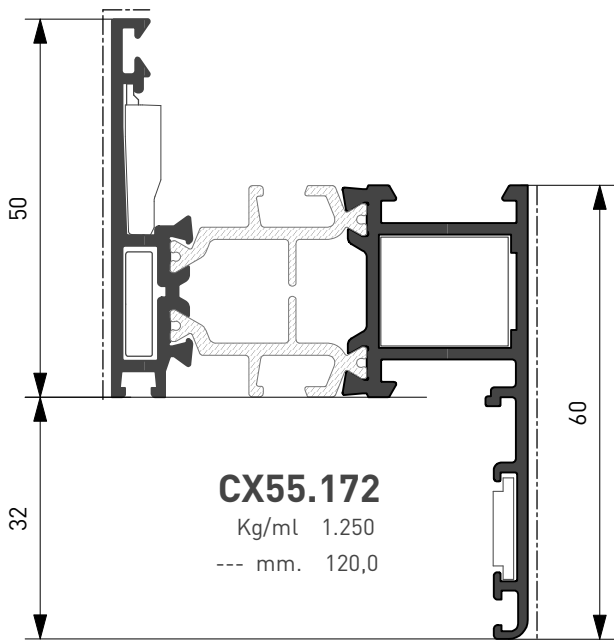

CX55.172

Kg/ml 1.250
--- mm. 120,0

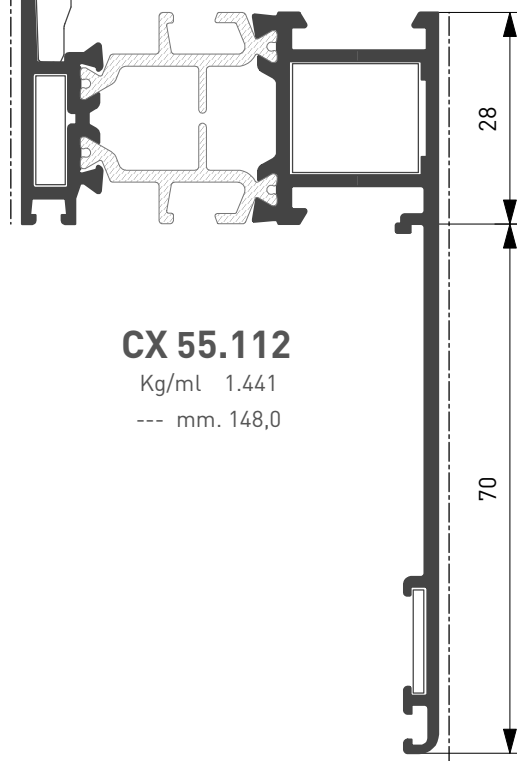

CX55.112

Kg/ml 1.441
--- mm. 148,0

Profilato Profile	Squadretta esterna External Corner Joint		Squadretta interna Internal Corner Joint				Sq. Allineamento Alining Corner J.	
	Cianfrinare Riveting	Spinare Crimping	Bottone Slot	Cianfrinare Riveting	Spinare Crimping	Avvitare Screw	Esterna External	Interna Internal
CX55.110	ARX.03.SQ	ARX.03.SQ + ARX.08.SQ	AWX.16.SQ		AWX.19.SQ		ARX.15.SQ	ARX.10.SQ
CX55.111	ARX.03.SQ	ARX.03.SQ + ARX.08.SQ	AWX.16.SQ		AWX.19.SQ		ARX.15.SQ	ARX.10.SQ
CX55.112	ARX.03.SQ	ARX.03.SQ + ARX.08.SQ	AWX.16.SQ		AWX.19.SQ		ARX.15.SQ	ARX.10.SQ
CX55.172	ARX.03.SQ	ARX.03.SQ + ARX.08.SQ	AWX.16.SQ		AWX.19.SQ		ARX.15.SQ	ARX.10.SQ

ATTENZIONE! per spinatura aggiungere anche LM0088 | Per avvitatura aggiungere anche VILM 5x14_D8
ATTENTION! For crimping add LM0088 | For screw add VILM 5x14_D8

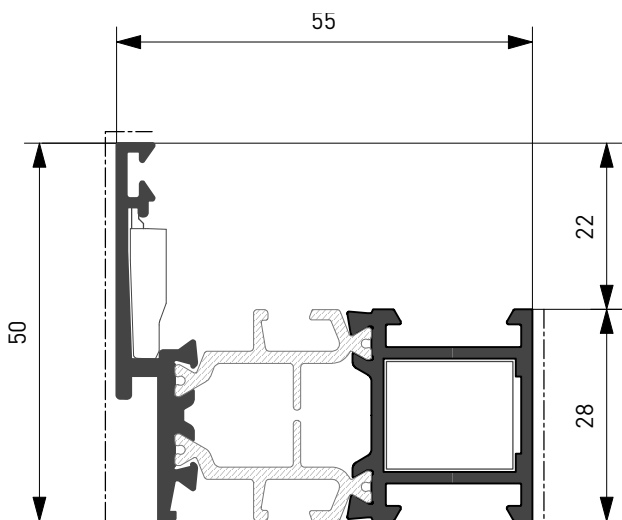

CX55.124

Kg/ml 1.048
--- mm. 78,0

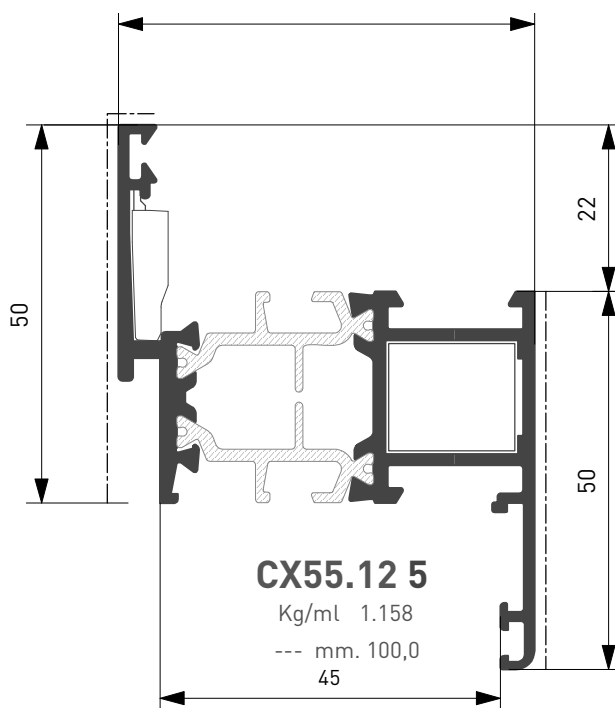

CX55.125

Kg/ml 1.158
--- mm. 100,0
45

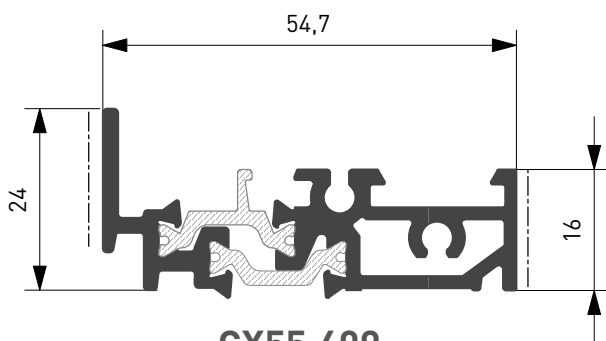

CX55.409

Kg/ml 0.939
--- mm. 34,0

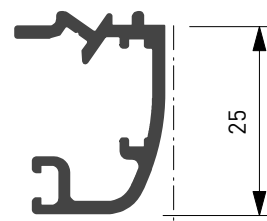

XX60.635

Kg/ml 0.306
--- mm. 41,0

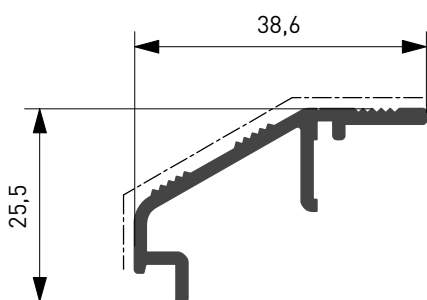

XX70.606

Kg/ml 0.322
--- mm. 50,0

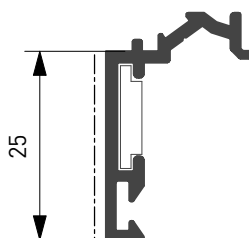

XX70.612

Kg/ml 0.245
--- mm. 25,0

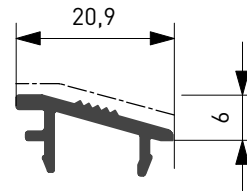

CX55.607

Kg/ml 0.149
--- mm. 32,0

Profilato Profile	Squadretta esterna External Corner Joint		Squadretta interna Internal Corner Joint				Sq. Allineamento Alining Corner J.	
	Cianfrinare Riveting	Spinare Crimping	Bottone Slot	Cianfrinare Riveting	Spinare Crimping	Avvitare Screw	Esterna External	Interna Internal
CX55.124			AWX.16.SQ		AWX.19.SQ		ARX.15.SQ	
CX55.125			AWX.16.SQ		AWX.19.SQ		ARX.15.SQ	ARX.10.SQ

ATTENZIONE! per spinatura aggiungere anche LM0088 | Per avvitatura aggiungere anche VILM 5x14_D8
ATTENTION! For crimping add LM0088 | For screw add VILM 5x14_D8

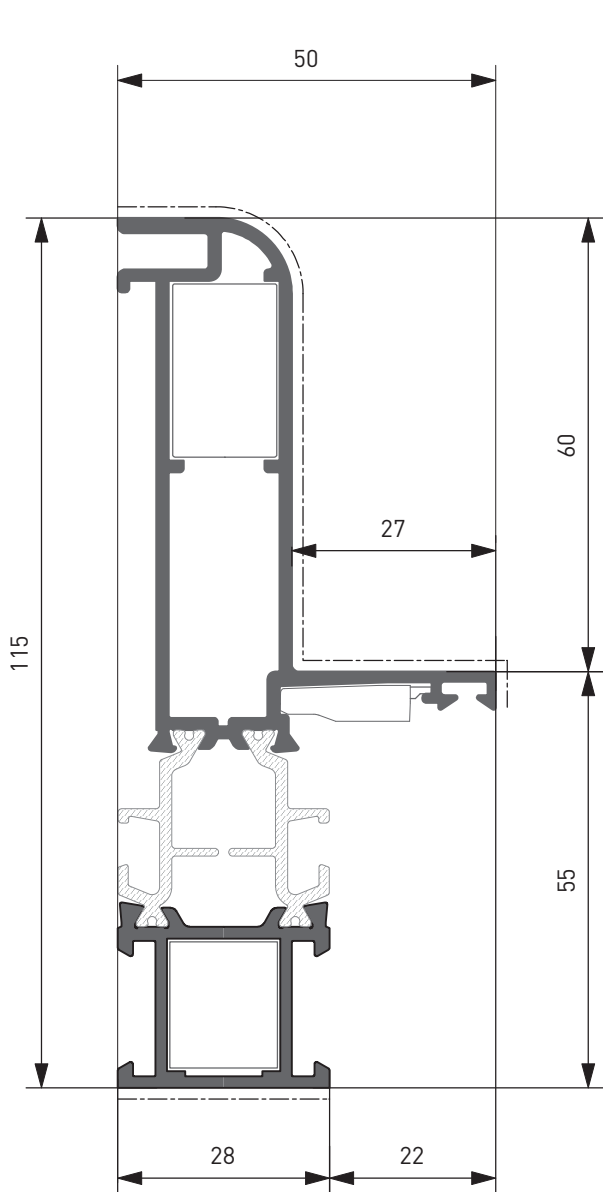

CX55.116
Kg/ml 1.670
--- mm. 143,0

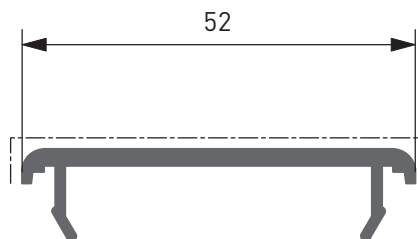

RX70.609
Kg/ml 0,393
--- mm. 55,0

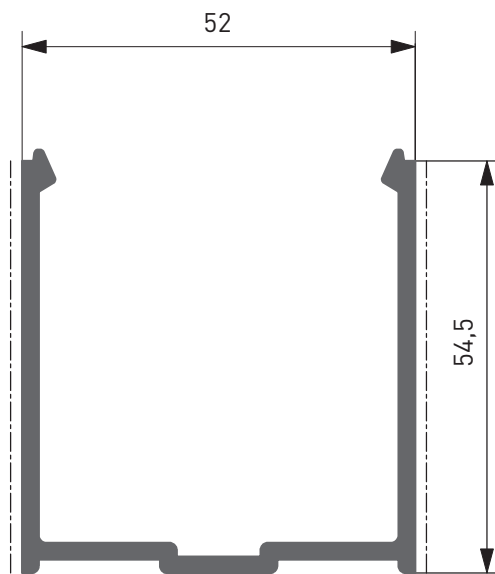

RX70.610
Kg/ml 0,994
--- mm. 109,0

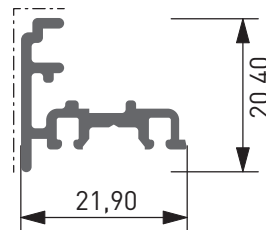

XX70.643
Kg/ml 0,264
--- mm. 28,0

Profilato Profile	Squadretta esterna External Corner Joint		Squadretta interna Internal Corner Joint			Sq. Allineamento Alining Corner J.	
	Bottone Slot		Cianfrinare Riveting	Spinare Crimping	Avvitare Screw	Esterna External	Interna Internal
CX55.116	ARX.13.SQ a bottone		AWX.16.SQ	AWX.19.SQ		ARX.15.SQ	

ATTENZIONE! per spinatura aggiungere anche LM0088 | Per avvitatura aggiungere anche VILM 5x14_D8
ATTENTION! For crimping add LM0088 | For screw add VILM 5x14_D8

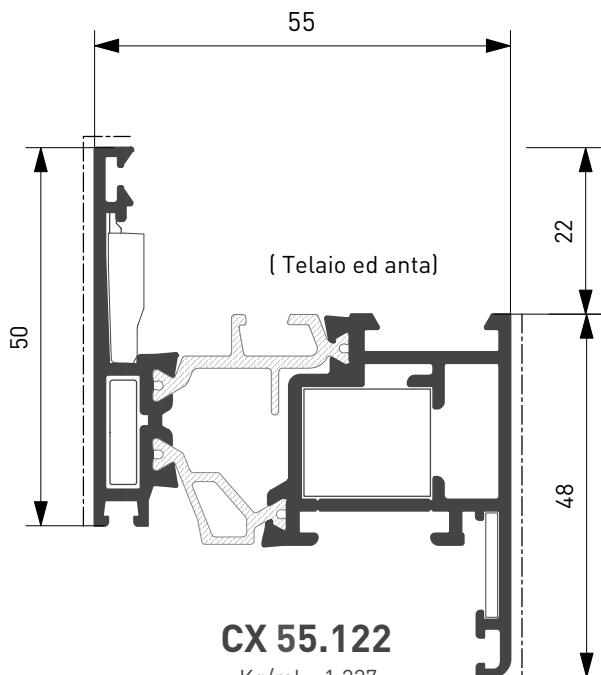

CX 55.122

Kg/ml 1.227

--- mm. 98

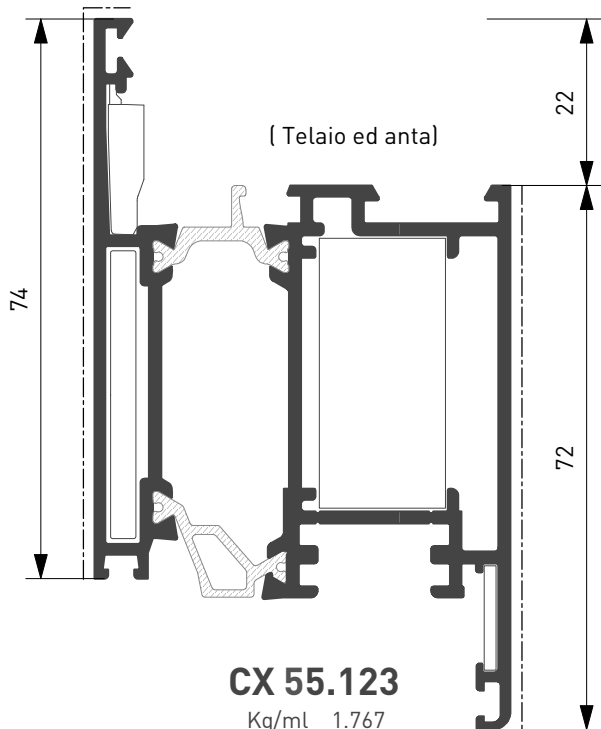

CX 55.123

Kg/ml 1.767

--- mm. 146

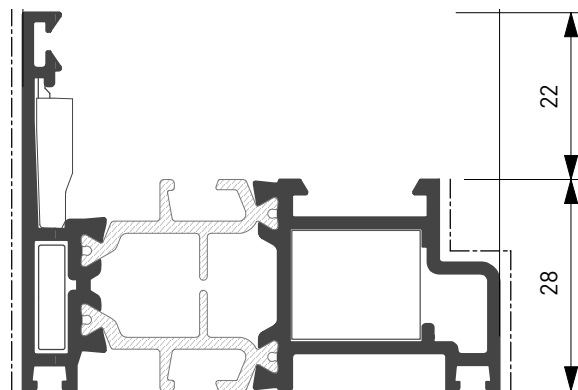

CX 55.119

Kg/ml 1.144

--- mm. 86,0

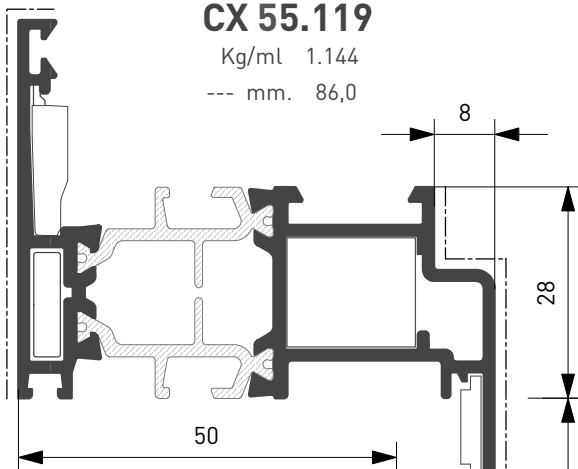

CX 55.120

Kg/ml 1.388

--- mm. 111,0

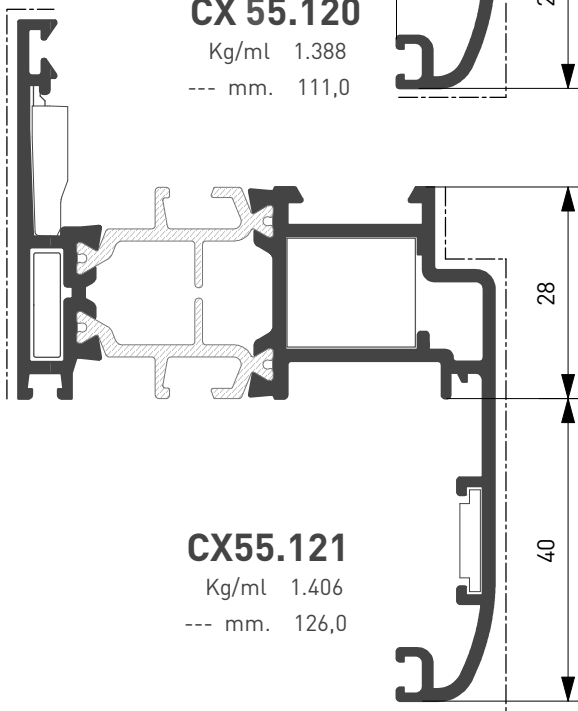

CX55.121

Kg/ml 1.406

--- mm. 126,0

Profilato Profile	Squadretta esterna External Corner Joint		Squadretta interna Internal Corner Joint				Sq. Allineamento Alining Corner J.			
	Cianfrinare Riveting	Spinare Crimping	Bottone Slot	Cianfrinare Riveting	Spinare Crimping	Avvitare Screw	Esterna External	Interna Internal	Esterna External	Interna Internal
CX55.119	ARX.03.SQ	ARX.03.SQ + ARX.08.SQ	AWX.16.SQ		AWX.19.SQ		ARX.15.SQ			
CX55.120	ARX.03.SQ	ARX.03.SQ + ARX.08.SQ	AWX.16.SQ		AWX.19.SQ		ARX.15.SQ		ARX.10.SQ	
CX55.121	ARX.03.SQ	ARX.03.SQ + ARX.08.SQ	AWX.16.SQ		AWX.19.SQ		ARX.15.SQ		ARX.10.SQ	
CX55.122	ARX.03.SQ	ARX.03.SQ + ARX.08.SQ	AWX.16.SQ		AWX.19.SQ		ARX.15.SQ		ARX.10.SQ	
CX55.123	ARX.06.SQ	ARX.06.SQ + ARX.08.SQ	AWX.16.SQ		AWX.19.SQ		ARX.15.SQ		ARX.10.SQ	

ATTENZIONE! per spinatura aggiungere anche LM0088 | **Per avvitatura aggiungere anche VILM 5x14_D8**
ATTENTION! For crimping add LM0088 | **For screw add VILM 5x14_D8**

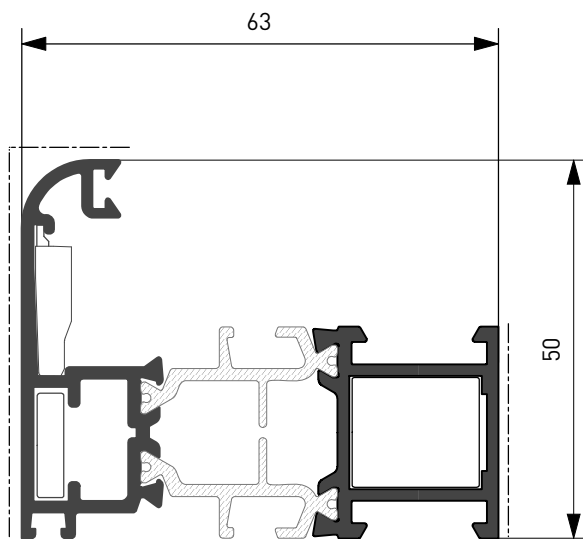

CX55.152

Kg/ml 1.223

--- mm. 86,0

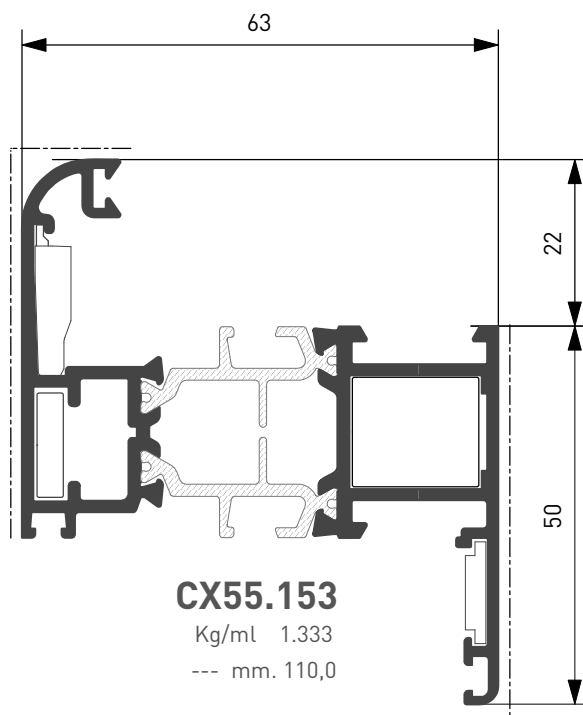

CX55.153

Kg/ml 1.333

--- mm. 110,0

Profilato Profile	Squadretta esterna External Corner Joint				Squadretta interna Internal Corner Joint						Sq. Allineamento Alining Corner J.			
	Cianfrinare Riveting		Spinare Crimping		Bottone Slot	Cianfrinare Riveting	Spinare Crimping	Avvitare Screw		Esterna External	Interna Internal			
CX55.152	ARX.03.SQ	ARX.03.SQ + ARX.08.SQ		AWX.16.SQ		AWX.19.SQ				ARX.15.SQ				
CX55.153	ARX.03.SQ	ARX.03.SQ + ARX.08.SQ		AWX.16.SQ		AWX.19.SQ				ARX.15.SQ		ARX.10.SQ		

ATTENZIONE! per spinatura aggiungere anche LM0088 | Per avvitatura aggiungere anche VILM 5x14_D8
ATTENTION! For crimping add LM0088 | For screw add VILM 5x14_D8

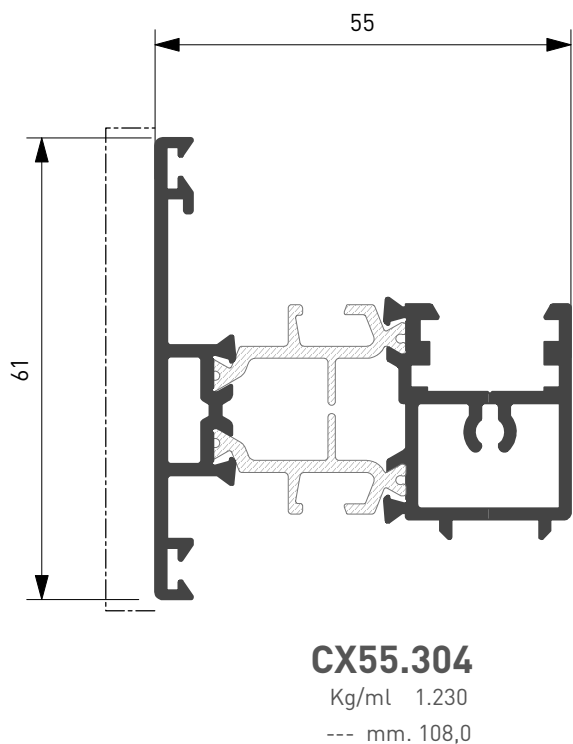
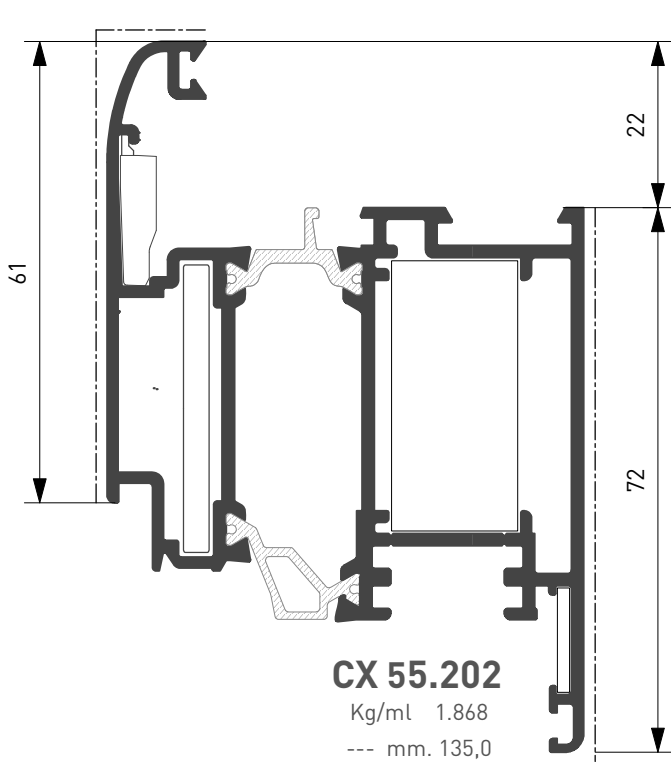
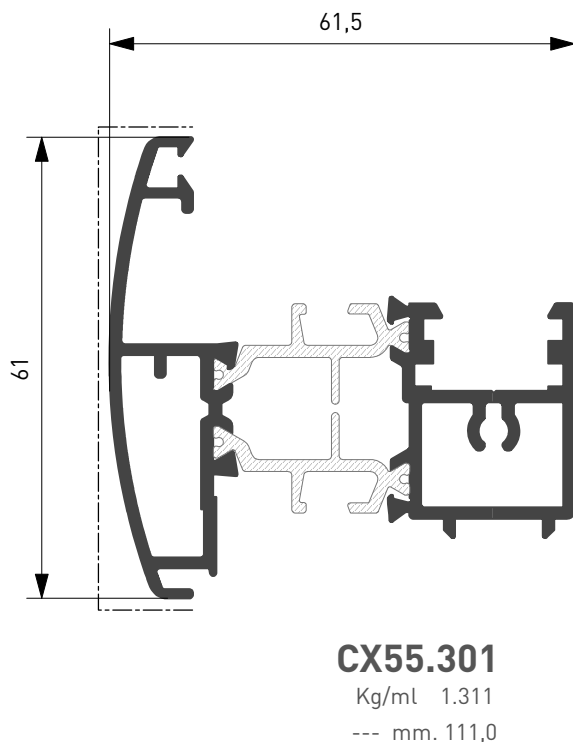
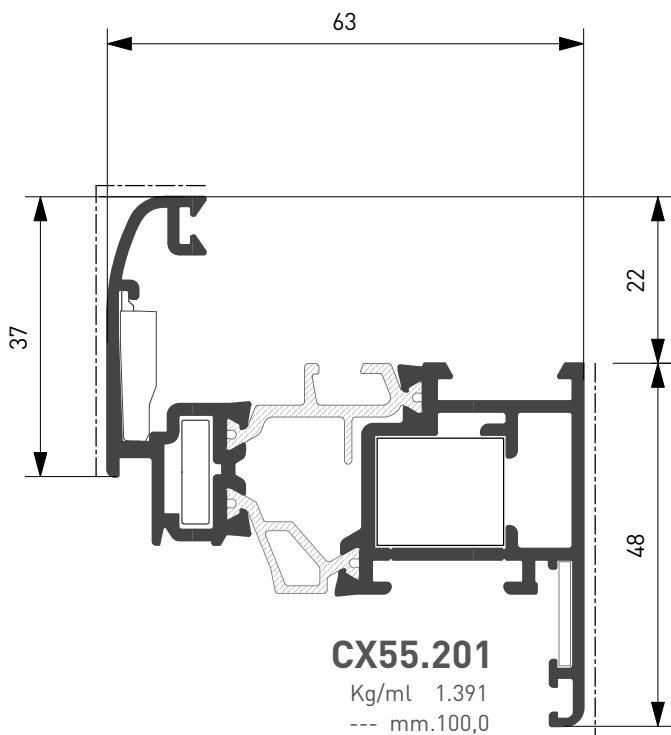

Profilato Profile	Squadretta esterna External Corner Joint		Squadretta interna Internal Corner Joint				Sq. Allineamento Alining Corner J.	
	Cianfrinare Riveting	Spinare Crimping	Bottone Slot	Cianfrinare Riveting	Spinare Crimping	Avvitare Screw	Esterna External	Interna Internal
CX55.201	ARX.03.SQ	ARX.03.SQ + ARX.08.SQ	AWX.16.SQ		AWX.19.SQ		ARX.15.SQ	ARX.10.SQ
CX55.202	ARX.06.SQ	ARX.06.SQ + ARX.08.SQ			AWX.17.SQ		ARX.15.SQ	ARX.10.SQ

ATTENZIONE! per spinatura aggiungere anche LM0088 | Per avvitatura aggiungere anche VILM 5x14_D8
ATTENTION! For crimping add LM0088 | For screw add VILM 5x14_D8

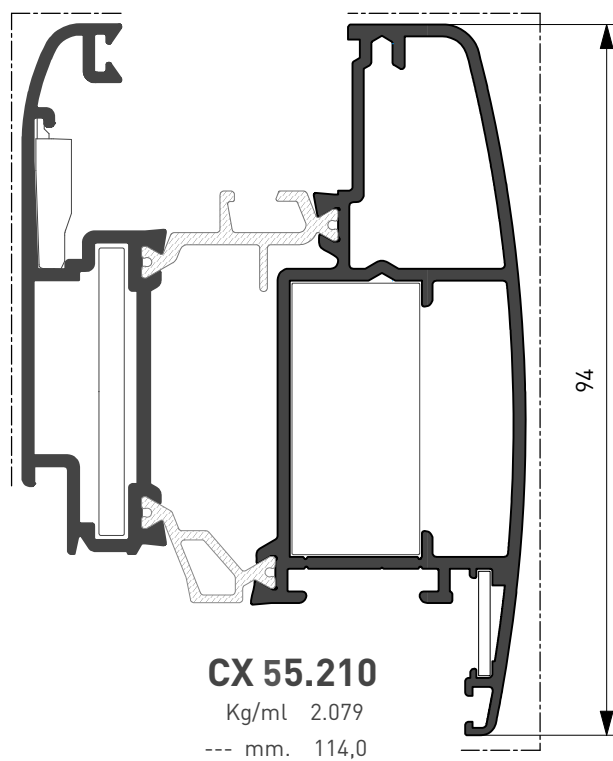
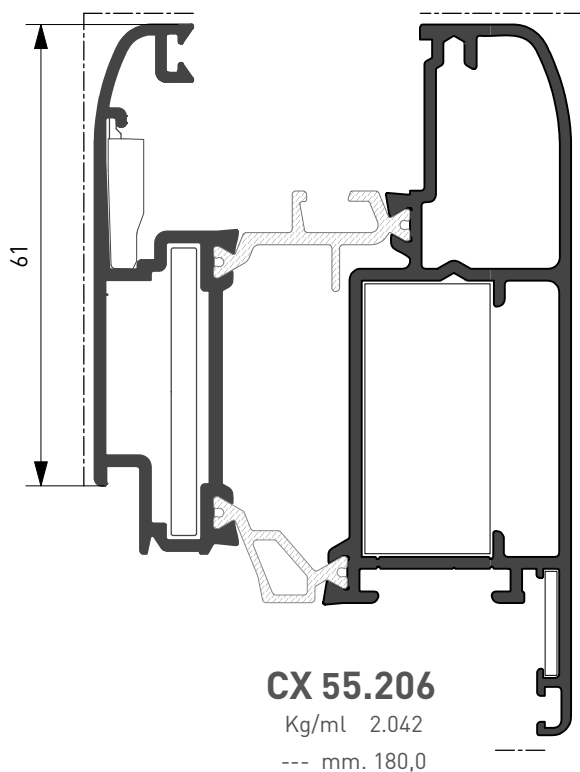
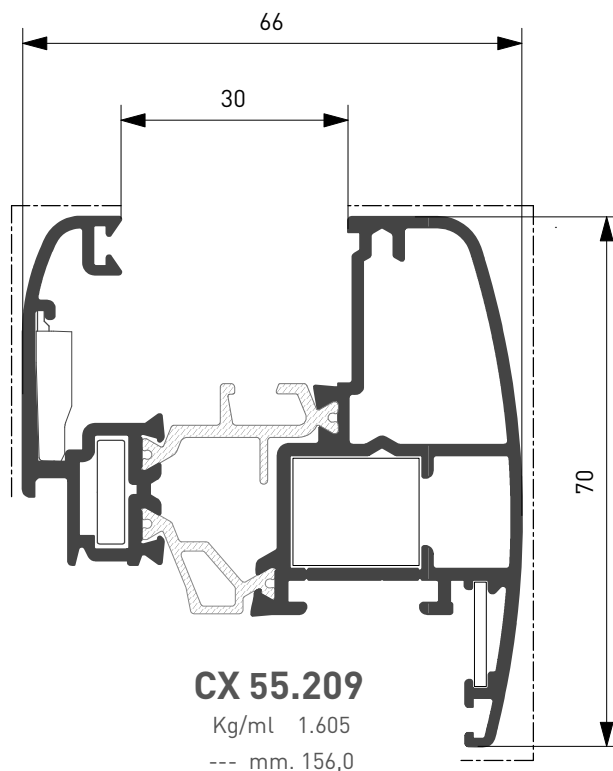
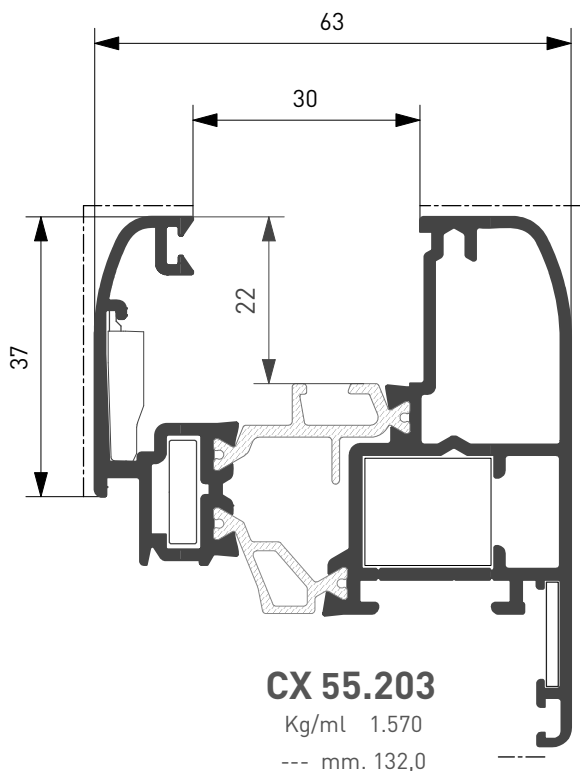

Profilato Profile	Squadretta esterna External Corner Joint		Squadretta interna Internal Corner Joint				Sq. Allineamento Alining Corner J.	
	Cianfrinare Riveting	Spinare Crimping	Bottone Slot	Cianfrinare Riveting	Spinare Crimping	Avvitare Screw	Esterna External	Interna Internal
CX55.203		ARX.03.SQ + ARX.08.SQ	AWX.16.SQ		AWX.19.SQ		ARX.15.SQ	ARX.10.SQ
CX55.206		ARX.06.SQ + ARX.08.SQ			AWX.17.SQ		ARX.15.SQ	ARX.10.SQ
CX55.209		ARX.03.SQ + ARX.08.SQ	AWX.16.SQ		AWX.19.SQ		ARX.15.SQ	ARX.10.SQ
CX55.210		ARX.06.SQ + ARX.08.SQ			AWX.17.SQ		ARX.15.SQ	

ATTENZIONE! per spinatura aggiungere anche LM0088 | Per avvitatura aggiungere anche VILM 5x14_D8
ATTENTION! For crimping add LM0088 | For screw add VILM 5x14_D8

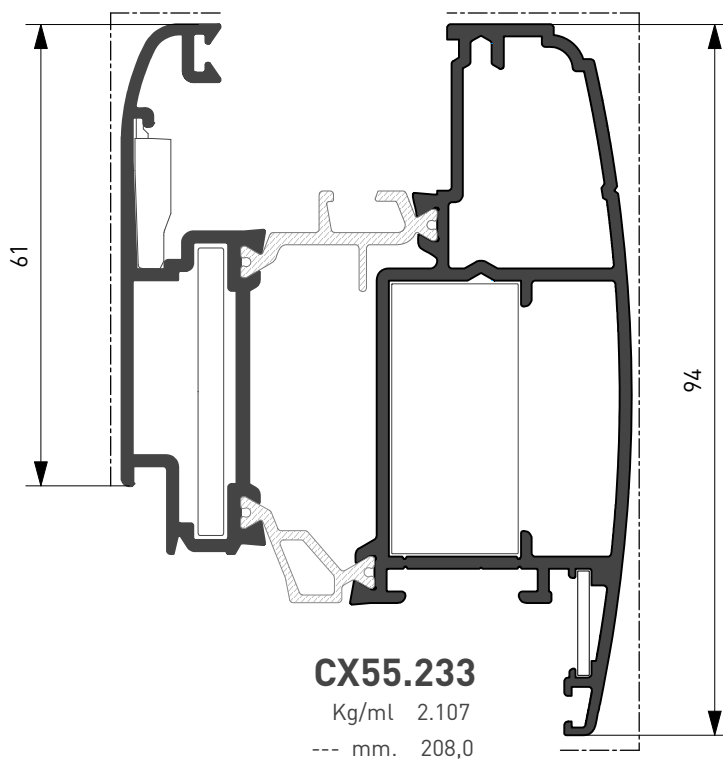
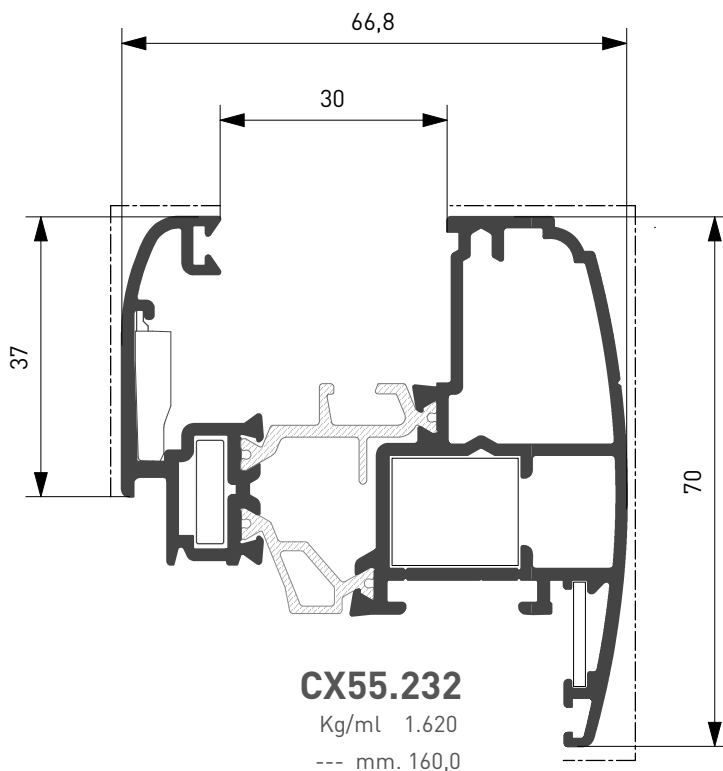

Profilato Profile	Squadretta esterna External Corner Joint				Squadretta interna Internal Corner Joint						Sq. Allineamento Alining Corner J.			
	Cianfrinare Riveting		Spinare Crimping		Bottone Slot	Cianfrinare Riveting	Spinare Crimping	Avvitare Screw		Esterna External	Interna Internal			
CX55.232	ARX.03.SQ	ARX.03.SQ + ARX.08.SQ			AWX.16.SQ		AWX.19.SQ				ARX.15.SQ		ARX.10.SQ	
CX55.233	ARX.06.SQ	ARX.06.SQ + ARX.08.SQ					AWX.17.SQ				ARX.15.SQ		ARX.10.SQ	

ATTENZIONE! per spinatura aggiungere anche LM0088 | Per avvitatura aggiungere anche VILM 5x14_D8
ATTENTION! For crimping add LM0088 | For screw add VILM 5x14_D8

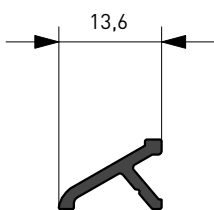
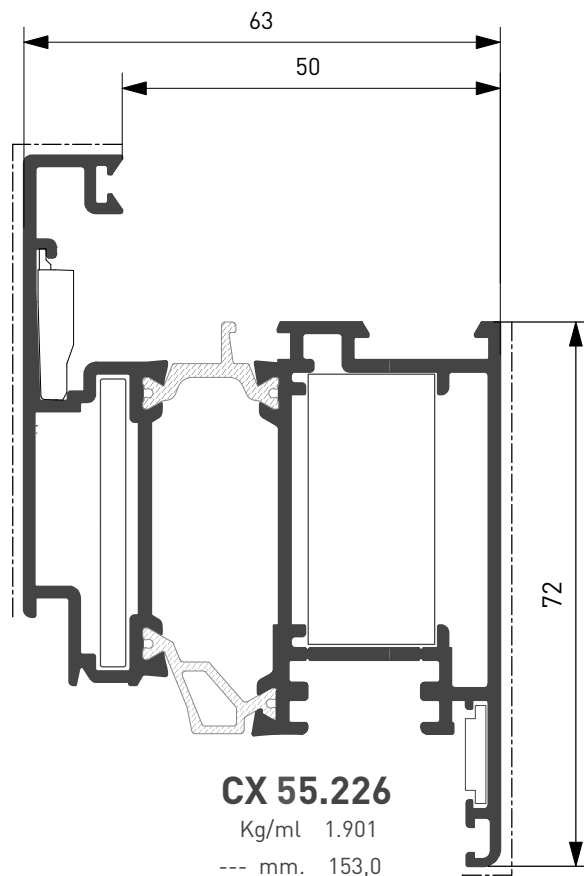
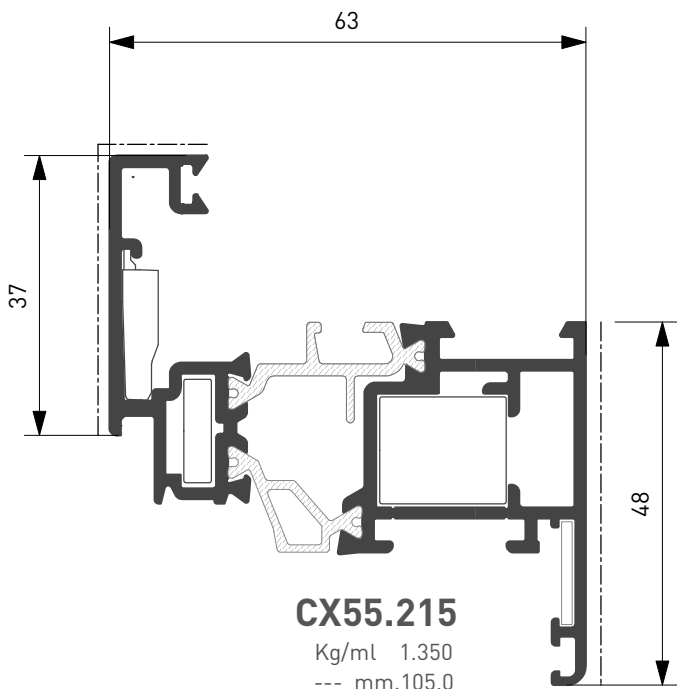

CX70.605
Kg/ml 0,146
--- mm. 14,0

Profilato Profile	Squadretta esterna External Corner Joint		Squadretta interna Internal Corner Joint				Sq. Allineamento Alining Corner J.	
	Cianfrinare Riveting	Spinare Crimping	Bottone Slot	Cianfrinare Riveting	Spinare Crimping	Avvitare Screw	Esterna External	Interna Internal
CX55.215	ARX.03.SQ	ARX.03.SQ + ARX.08.SQ	AWX.16.SQ		AWX.19.SQ		ARX.15.SQ	ARX.10.SQ
CX55.226	ARX.06.SQ	ARX.06.SQ + ARX.08.SQ			AWX.17.SQ		ARX.15.SQ	ARX.10.SQ

ATTENZIONE! per spinatura aggiungere anche LM0088 | Per avvitatura aggiungere anche VILM 5x14_D8
ATTENTION! For crimping add LM0088 | For screw add VILM 5x14_D8



FERRAMENTA A NASTRO
TAPE HARDWARE

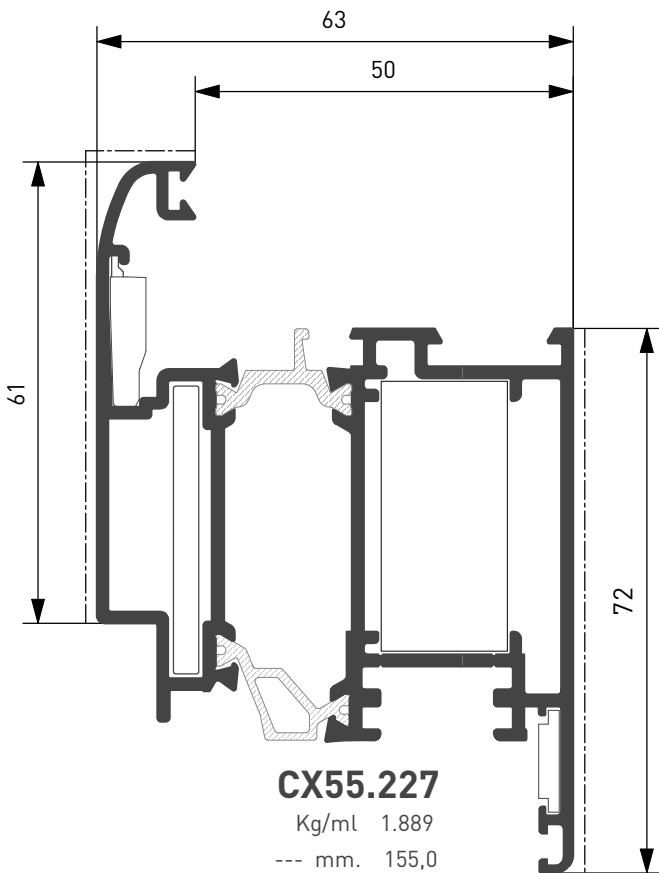
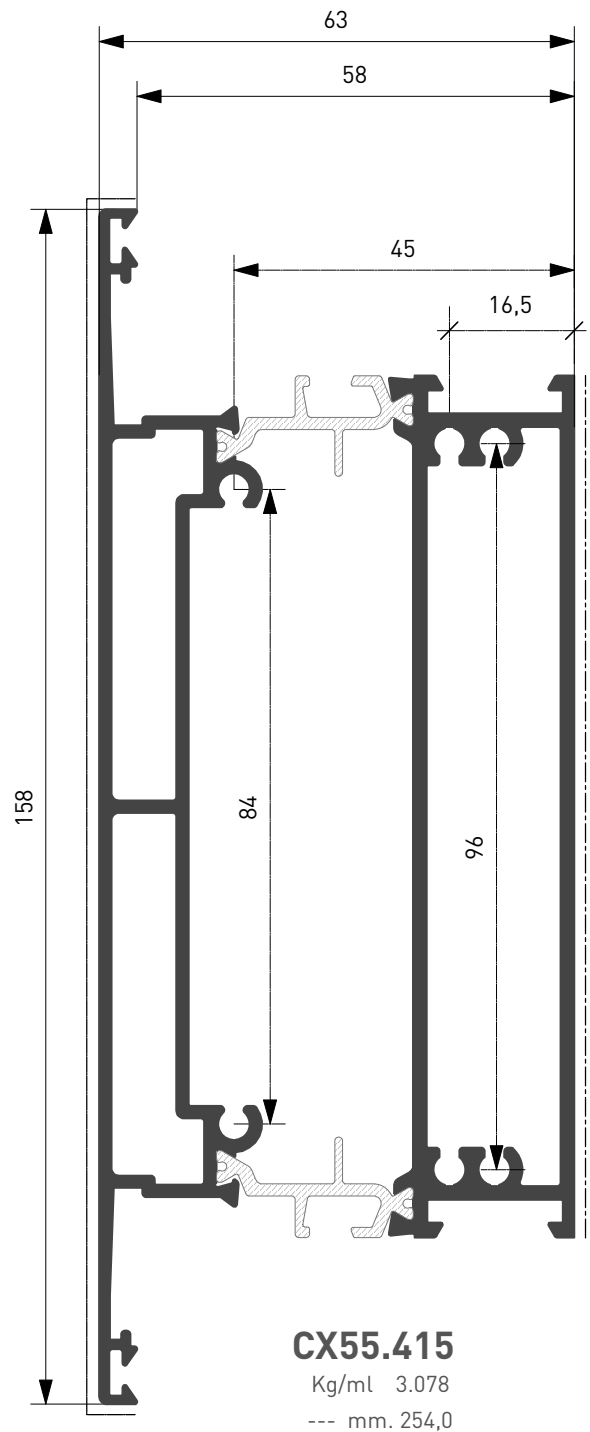
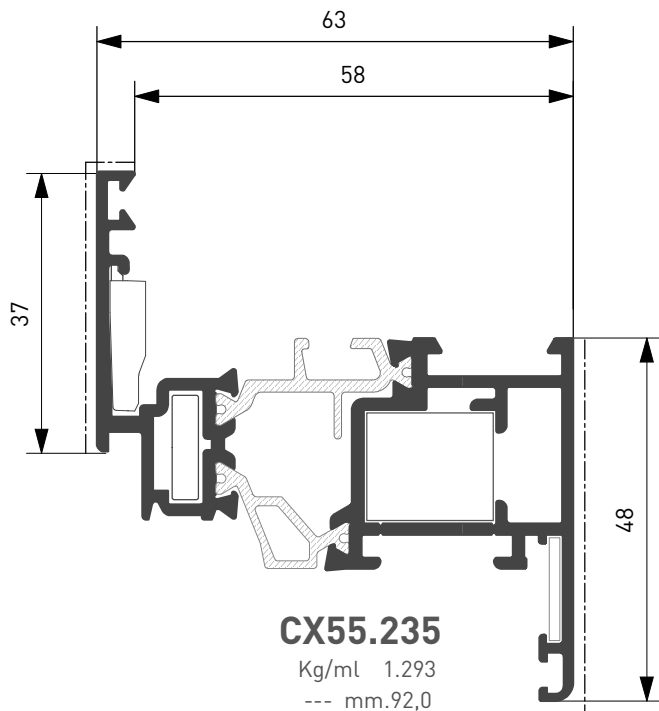

Profilato Profile	Squadretta esterna External Corner Joint		Squadretta interna Internal Corner Joint					Sq. Allineamento Alining Corner J.	
	Cianfrinare Riveting	Spinare Crimping	Bottone Slot	Cianfrinare Riveting	Spinare Crimping	Avvitare Screw	Esterna External	Interna Internal	
CX55.227	ARX.06.SQ	ARX.06.SQ + ARX.08.SQ			AWX.17.SQ		ARX.15.SQ	ARX.10.SQ	
CX55.235	ARX.03.SQ	ARX.03.SQ + ARX.08.SQ	AWX.16.SQ		AWX.19.SQ		ARX.15.SQ	ARX.10.SQ	

ATTENZIONE! per spinatura aggiungere anche LM0088 | Per avvitatura aggiungere anche VILM 5x14_D8
ATTENTION! For crimping add LM0088 | For screw add VILM 5x14_D8



Ferramenta a nastro
Tape Hardware

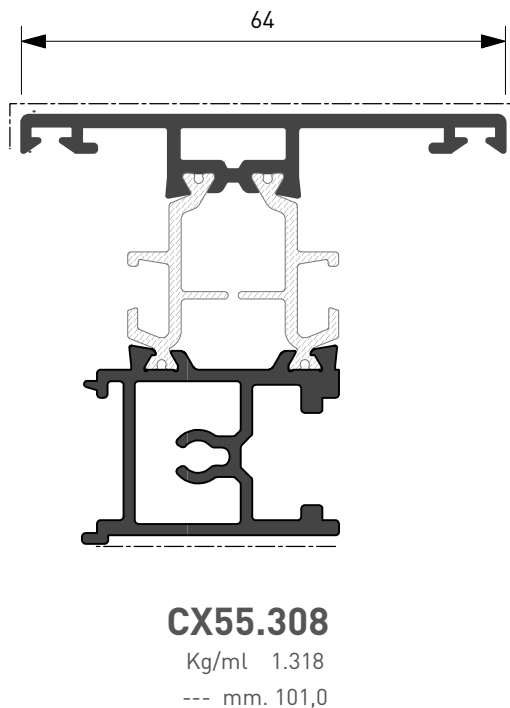
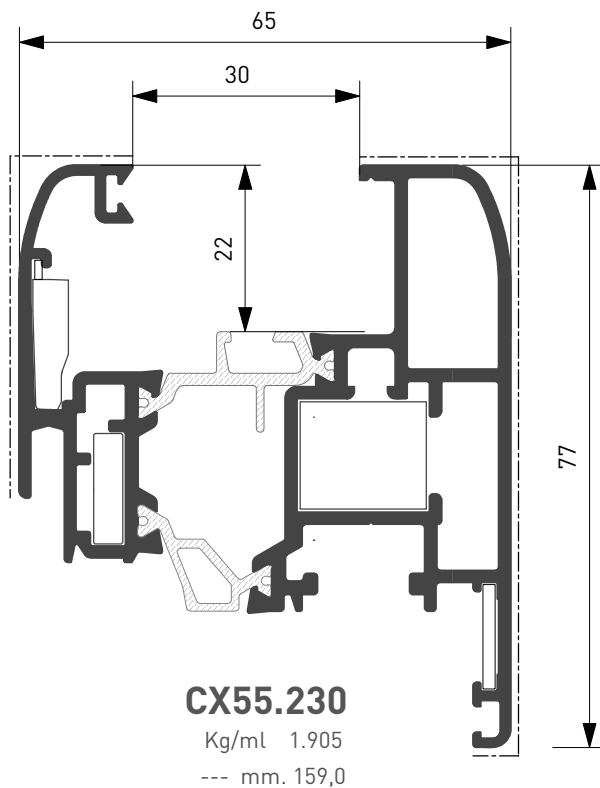
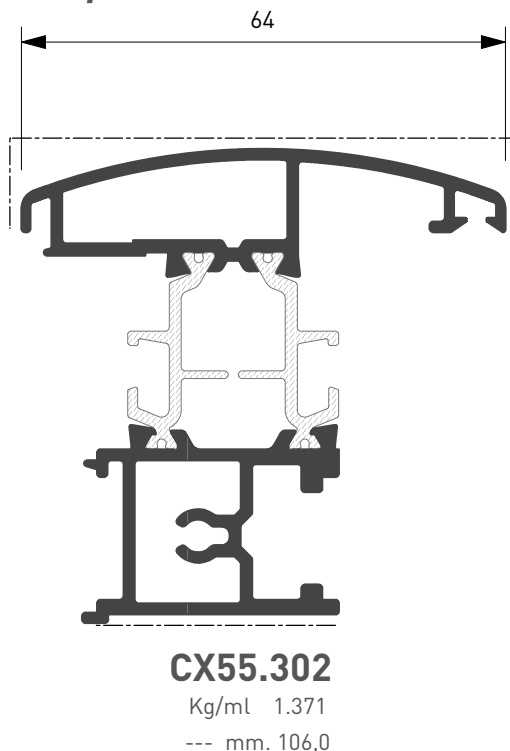
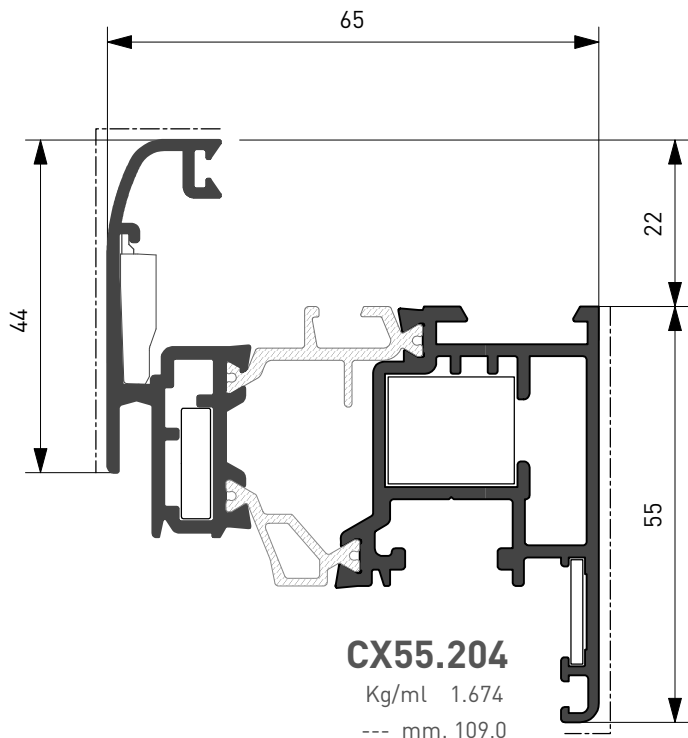

Profilato Profile	Squadretta esterna External Corner Joint		Squadretta interna Internal Corner Joint					Sq. Allineamento Alining Corner J.	
	Cianfrinare Riveting	Spinare Crimping	Bottone Slot	Cianfrinare Riveting	Spinare Crimping	Avvitare Screw	Esterna External	Interna Internal	
CX55.204	ARX.03.SQ	ARX.03.SQ + ARX.08.SQ	AWX.16.SQ		AWX.19.SQ		ARX.15.SQ		
CX55.230	ARX.03.SQ	ARX.03.SQ + ARX.08.SQ	AWX.16.SQ		AWX.19.SQ		ARX.15.SQ		

ATTENZIONE! per spinatura aggiungere anche LM0088 | Per avvitatura aggiungere anche VILM 5x14_D8
ATTENTION! For crimping add LM0088 | For screw add VILM 5x14_D8

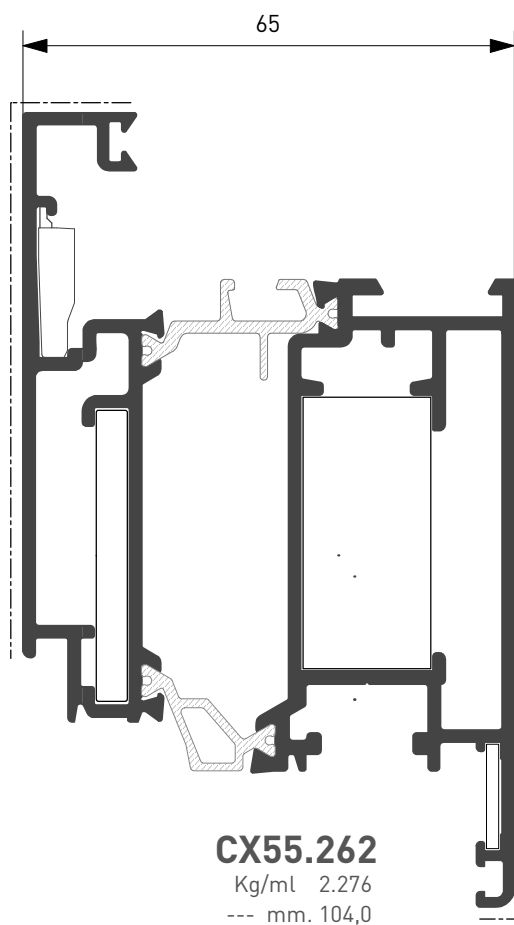
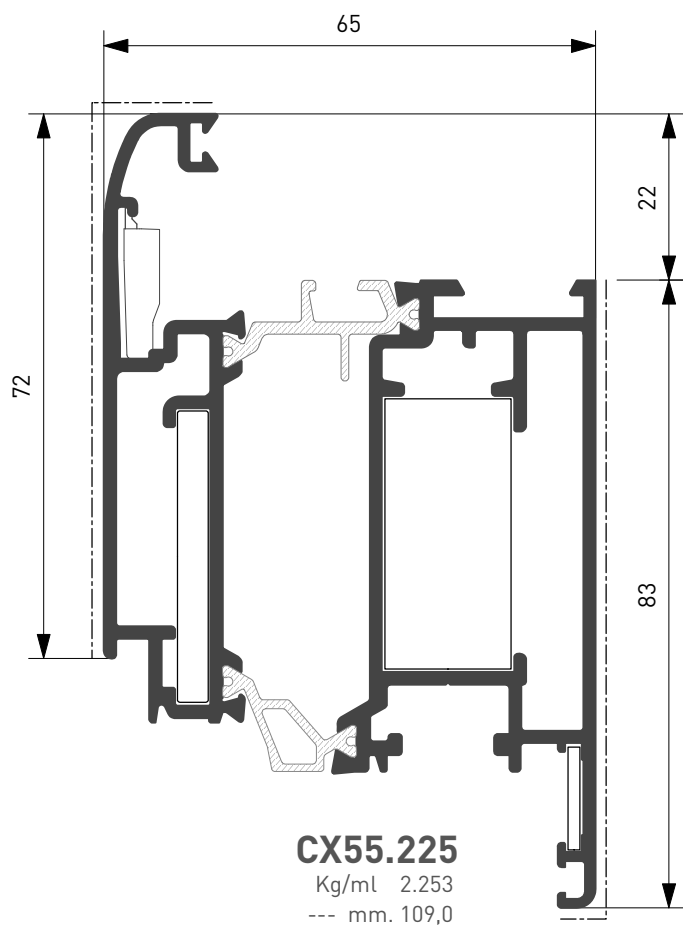
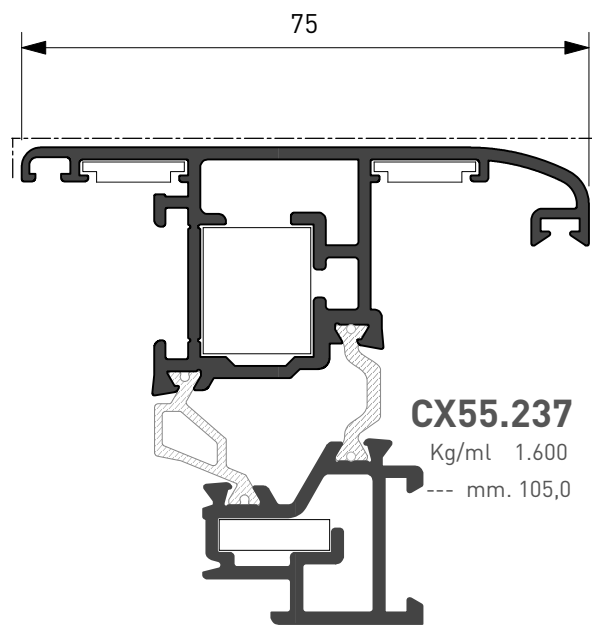
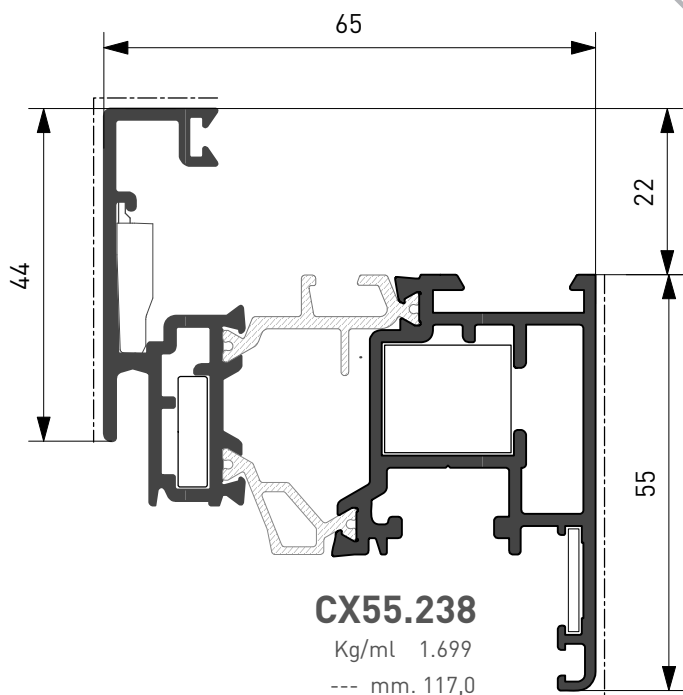

Profilato Profile	Squadretta esterna External Corner Joint		Squadretta interna Internal Corner Joint					Sq. Allineamento Alining Corner J.	
	Cianfrinare Riveting	Spinare Crimping	Bottone Slot	Cianfrinare Riveting	Spinare Crimping	Avvitare Screw	Esterna External	Interna Internal	
CX55.225	ARX.06.SQ	ARX.06.SQ + ARX.08.SQ			AWX.17.SQ		ARX.15.SQ		
CX55.237	ARX.03.SQ	ARX.03.SQ + ARX.08.SQ	AWX.16.SQ		AWX.19.SQ		ARX.10.SQ		
CX55.238	ARX.03.SQ	ARX.03.SQ + ARX.08.SQ	AWX.16.SQ		AWX.19.SQ		ARX.10.SQ		
CX55.262	ARX.06.SQ	ARX.06.SQ + ARX.08.SQ			AWX.17.SQ		ARX.15.SQ		

ATTENZIONE! per spinatura aggiungere anche LM0088 | Per avvitatura aggiungere anche VILM 5x14_D8
ATTENTION! For crimping add LM0088 | For screw add VILM 5x14_D8

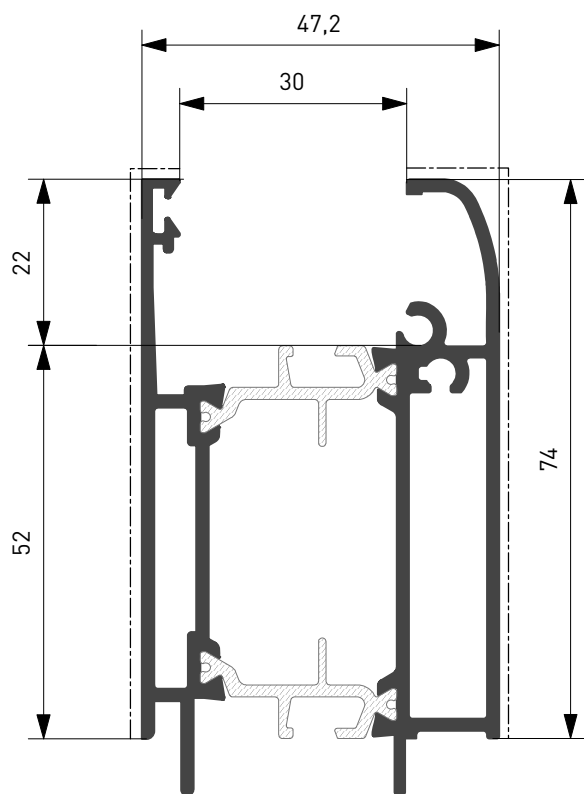

CX55.407

Kg/ml 1.689
--- mm. 162,0

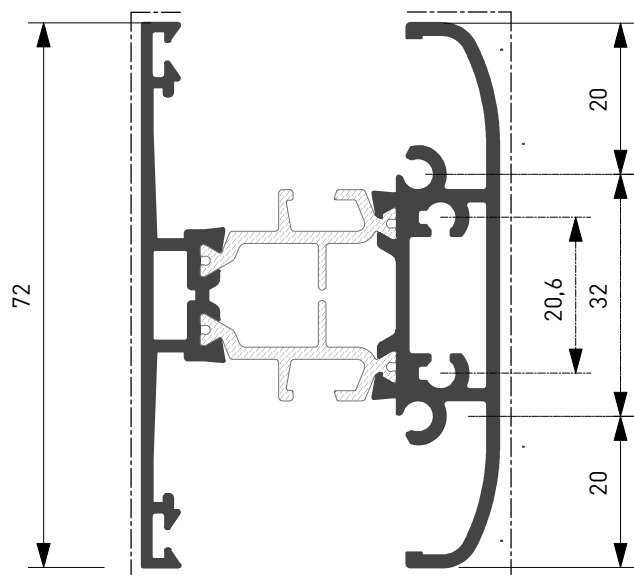

CX55.405

Kg/ml 1.506
--- mm. 1700

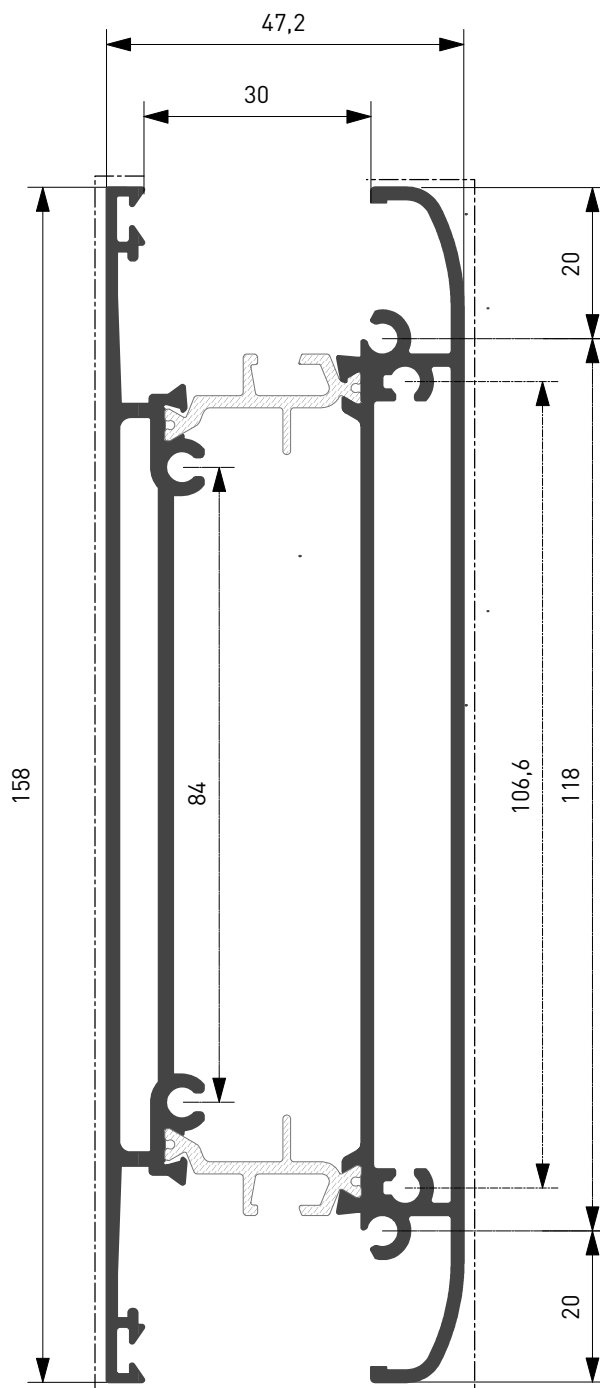

CX55.406

Kg/ml 3.125

Profilato Profile	Squadretta esterna External Corner Joint				Squadretta interna Internal Corner Joint						Sq. Allineamento Alining Corner J.			
	Cianfrinare Riveting		Spinare Crimping		Bottone Slot	Cianfrinare Riveting		Spinare Crimping		Avvitare Screw		Esterna External		Interna Internal

ATTENZIONE! per spinatura aggiungere anche LM0088 | Per avvitatura aggiungere anche VILM 5x14_D8
ATTENTION! For crimping add LM0088 | For screw add VILM 5x14_D8

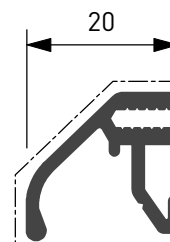
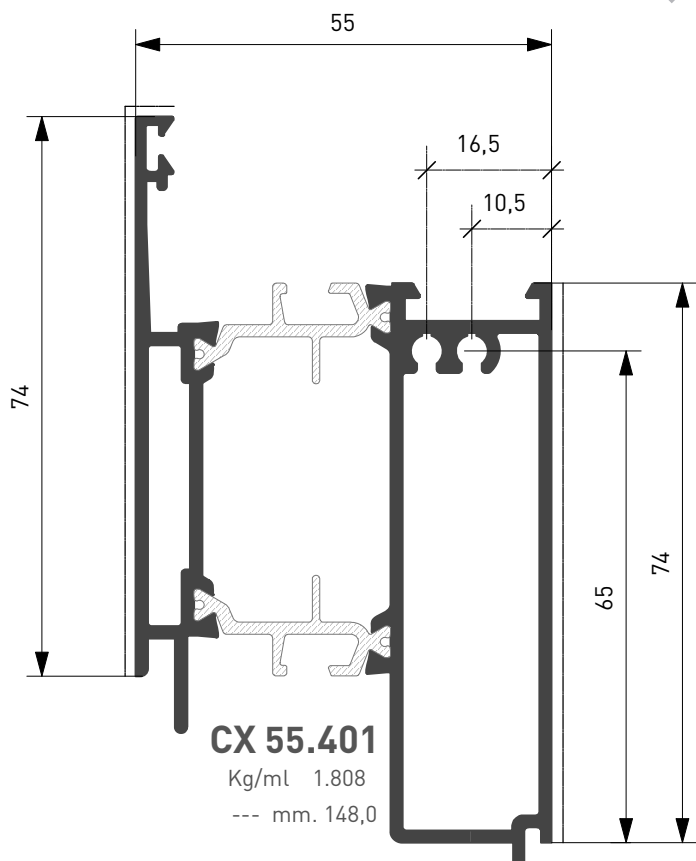

XX70.601
Kg/ml 0.269
--- mm. 28,0

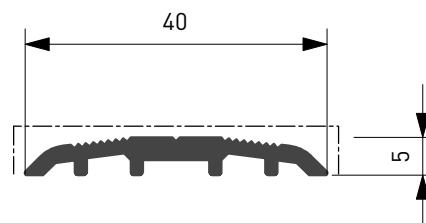

XX70.603
Kg/ml 0.275
--- mm. 40,0

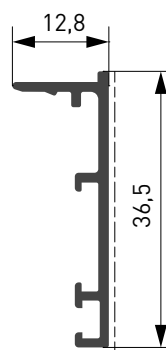
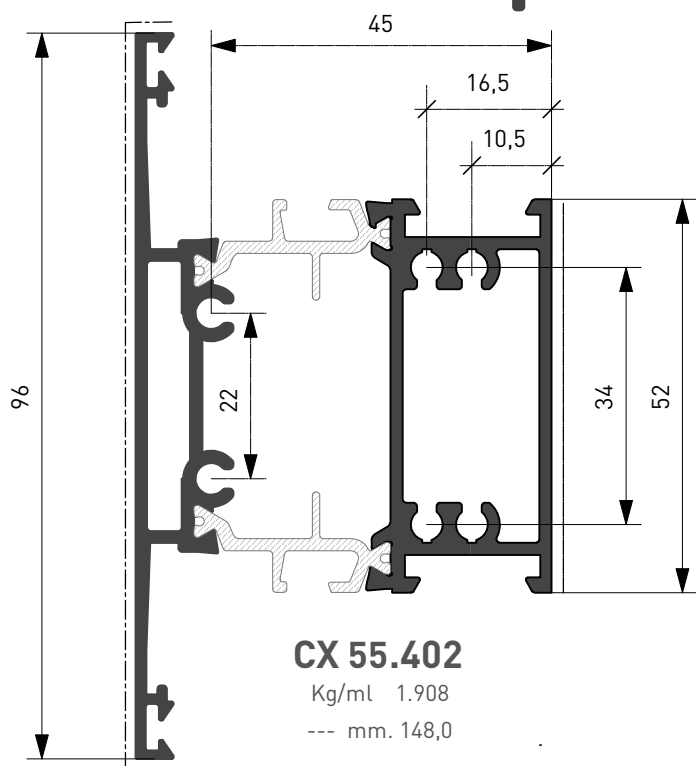

XX70.503
Kg/ml 0.224
--- mm. 42,0

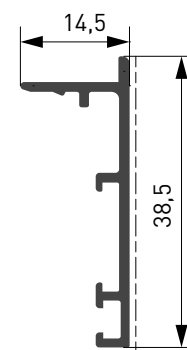

XX70.504
Kg/ml 0.238
--- mm. 44,0

Profilato Profile	Squadretta esterna External Corner Joint				Squadretta interna Internal Corner Joint						Sq. Allineamento Alining Corner J.			
	Cianfrinare Riveting	Spinare Crimping	Bottone Slot	Cianfrinare Riveting	Spinare Crimping	Avvitare Screw	Esterna External	Interna Internal	Esterna External	Interna Internal				

ATTENZIONE! per spinatura aggiungere anche LM0088 | Per avvitatura aggiungere anche VILM 5x14_D8
ATTENTION! For crimping add LM0088 | For screw add VILM 5x14_D8

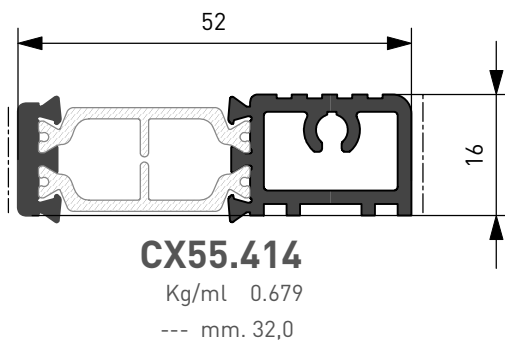
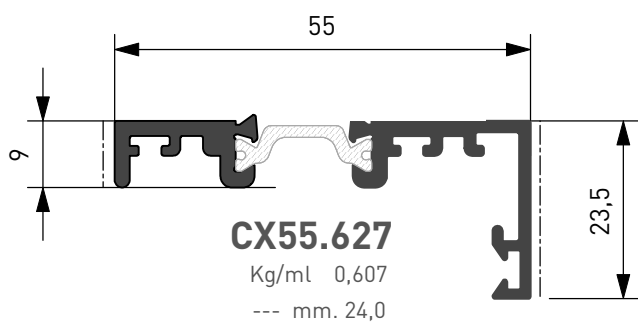
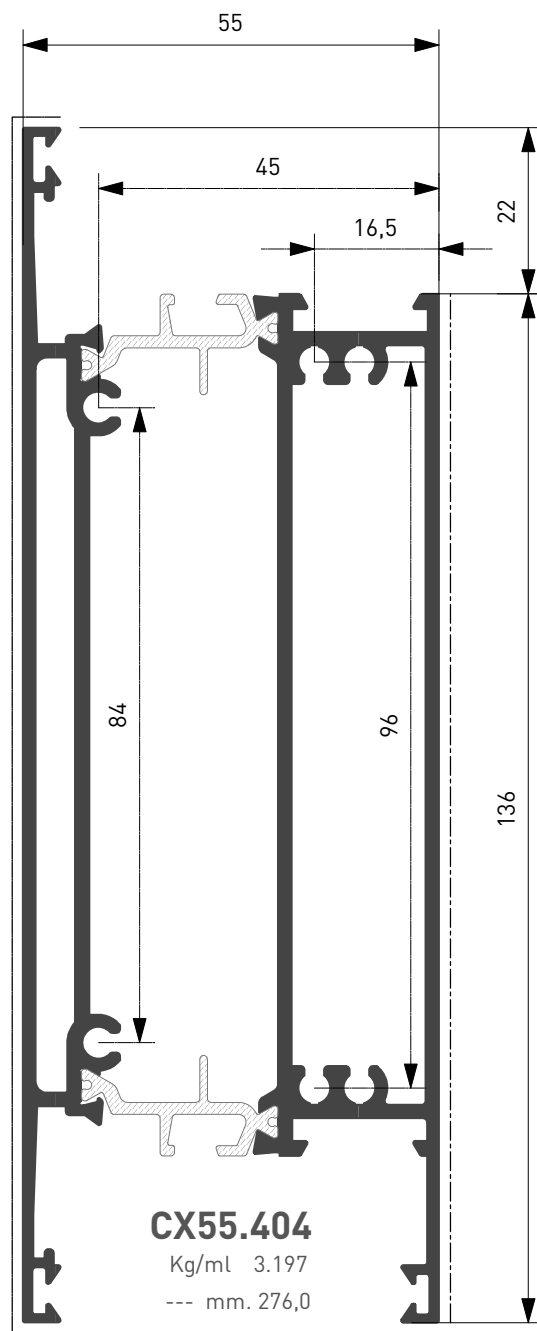
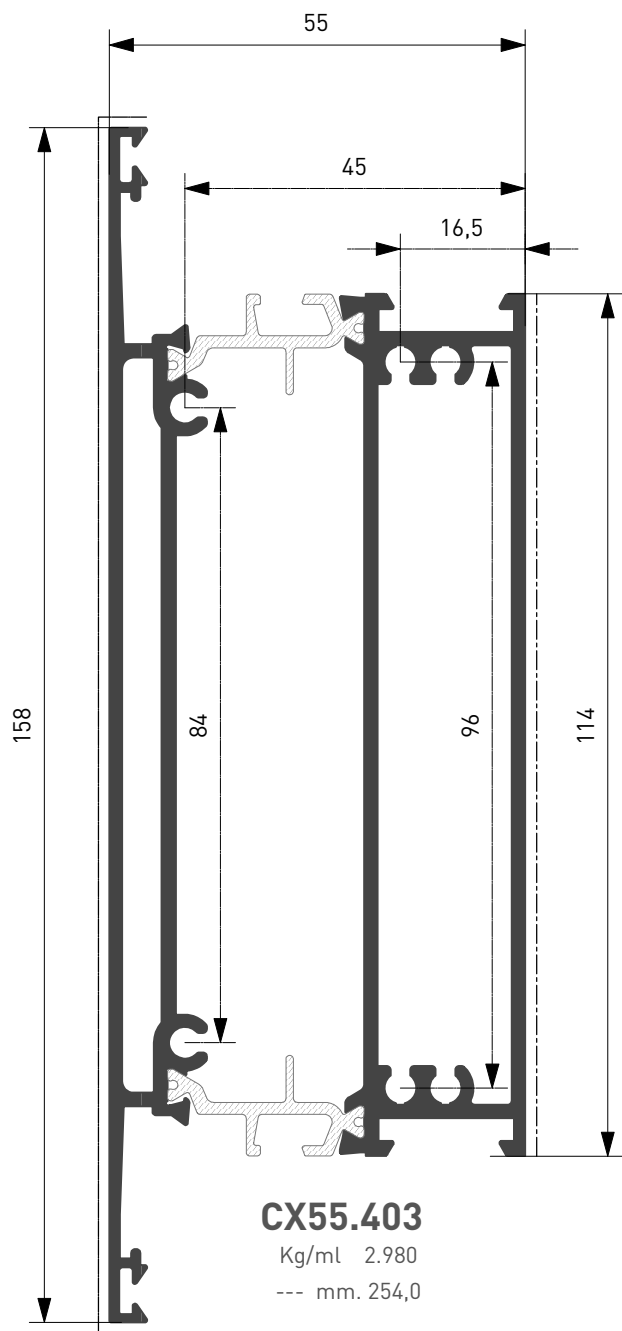

Profilato Profile	Squadretta esterna External Corner Joint				Squadretta interna Internal Corner Joint						Sq. Allineamento Alining Corner J.			
	Cianfrinare Riveting	Spinare Crimping	Bottone Slot	Cianfrinare Riveting	Spinare Crimping	Avvitare Screw	Esterna External	Interna Internal	Esterna External	Interna Internal				

ATTENZIONE! per spinatura aggiungere anche LM0088 | Per avvitatura aggiungere anche VILM 5x14_D8
ATTENTION! For crimping add LM0088 | For screw add VILM 5x14_D8

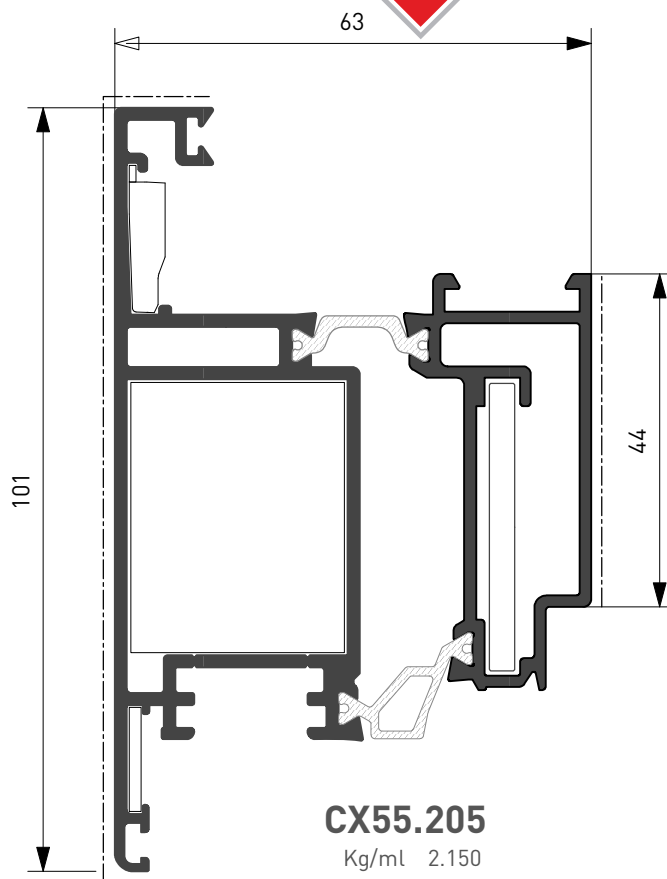

CX55.205

Kg/ml 2.150

--- mm. 147,0

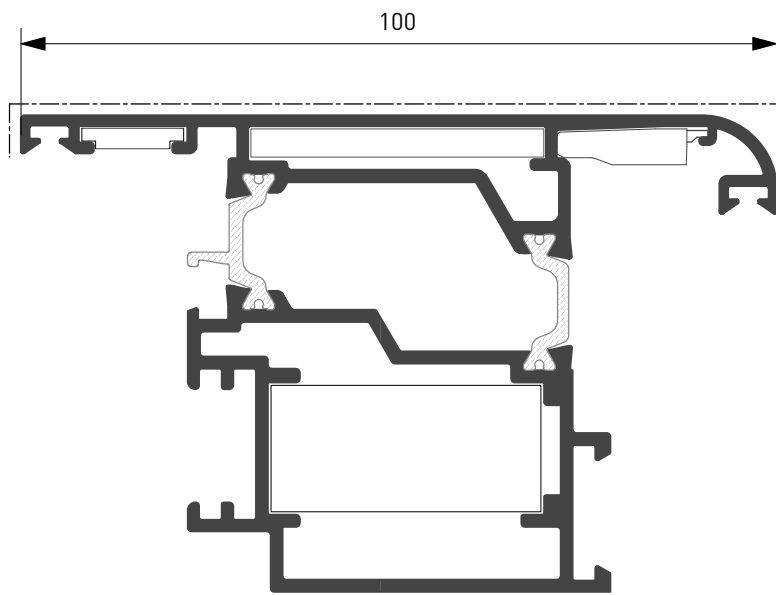

CX55.207

Kg/ml 2.011

--- mm. 155,0

Profilato Profile	Squadretta esterna External Corner Joint		Squadretta interna Internal Corner Joint						Sq. Allineamento Alining Corner J.	
	Cianfrinare Riveting	Spinare Crimping	Bottone Slot	Cianfrinare Riveting	Spinare Crimping	Avvitare Screw	Esterna External	Interna Internal		
CX55.205	ARX.06.SQ	ARX.06.SQ + ARX.08.SQ			ACX.14.SQ		ARX.09.SQ	ARX.10.SQ		
CX55.207	ARX.06.SQ				AWX.17.SQ		ARX.09.SQ	ARX.10.SQ		

ATTENZIONE! per spinatura aggiungere anche LM0088 | Per avvitatura aggiungere anche VILM 5x14_D8
ATTENTION! For crimping add LM0088 | For screw add VILM 5x14_D8

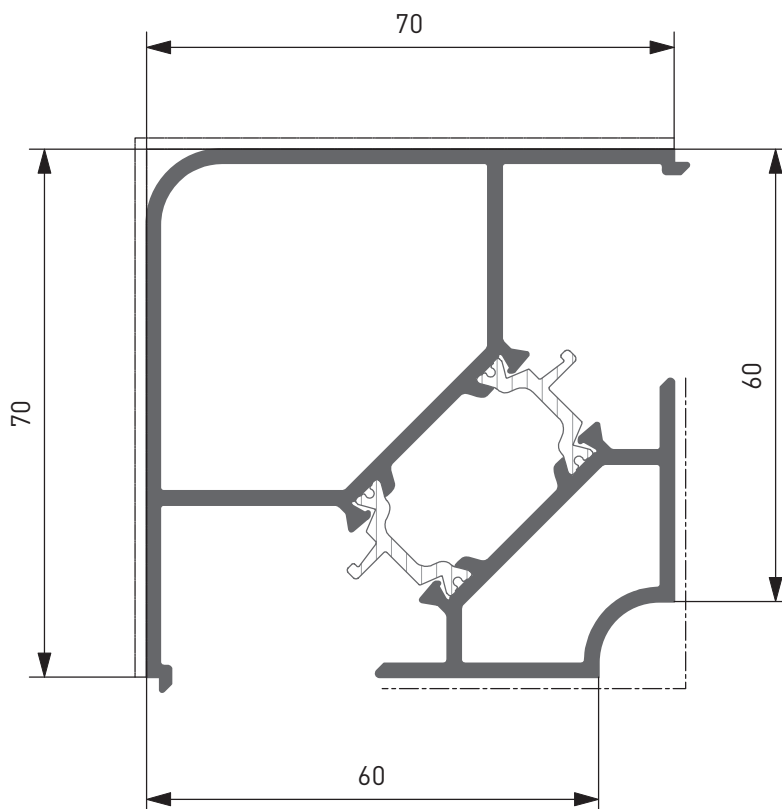

XX70.613

Kg/ml 1,885
--- mm. 215,0

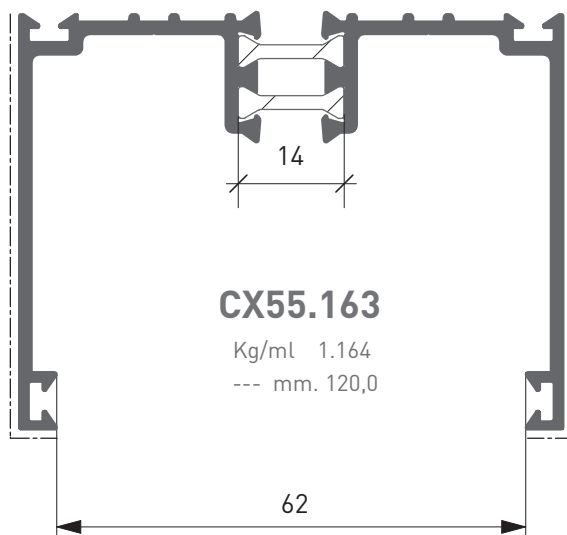

CX55.163

Kg/ml 1.164
--- mm. 120,0

Profilato Profile	Squadretta esterna External Corner Joint				Squadretta interna Internal Corner Joint						Sq. Allineamento Alining Corner J.			
	Cianfrinare Riveting		Spinare Crimping		Bottone Slot	Cianfrinare Riveting	Spinare Crimping	Avvitare Screw		Esterna External	Interna Internal			

ATTENZIONE! per spinatura aggiungere anche LM0088 | Per avvitatura aggiungere anche VILM 5x14_D8
ATTENTION! For crimping add LM0088 | For screw add VILM 5x14_D8

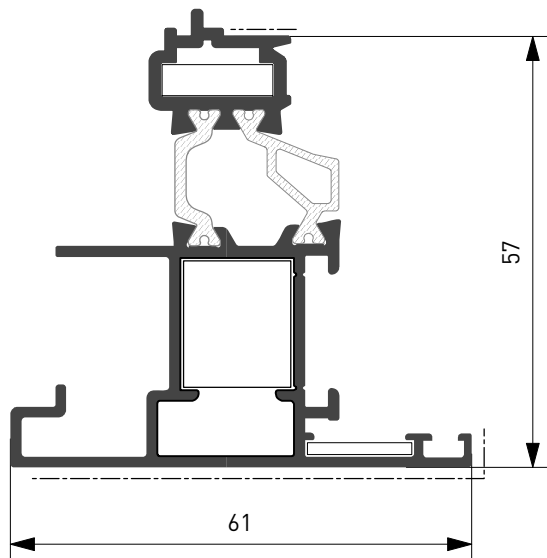

CX55.303

Kg/ml 1.213

--- mm. 64,0

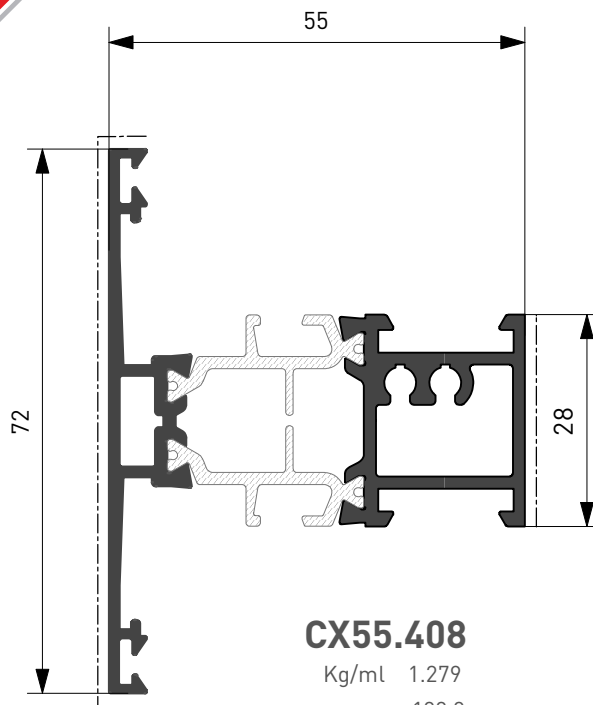

CX55.408

Kg/ml 1.279

--- mm. 100,0

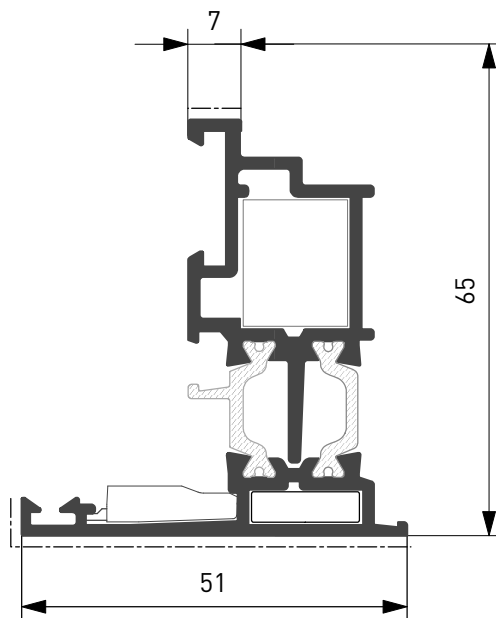

CX55.604

Kg/ml 1.128

--- mm. 58,0

Profilato Profile	Squadretta esterna External Corner Joint		Squadretta interna Internal Corner Joint					Sq. Allineamento Alining Corner J.	
	Cianfrinare Riveting	Spinare Crimping	Bottone Slot	Cianfrinare Riveting	Spinare Crimping	Avvitare Screw	Esterna External	Interna Internal	
CX55.303	ARX.03.SQ	ARX.03.SQ + ARX.08.SQ	AWX.16.SQ		AWX.19.SQ			ARX.10.SQ	
CX55.604	ARX.03.SQ	ARX.06.SQ + ARX.08.SQ	AWX.16.SQ		AWX.19.SQ		ARX.15.SQ		

ATTENZIONE! per spinatura aggiungere anche LM0088 | Per avvitatura aggiungere anche VILM 5x14_D8
ATTENTION! For crimping add LM0088 | For screw add VILM 5x14_D8

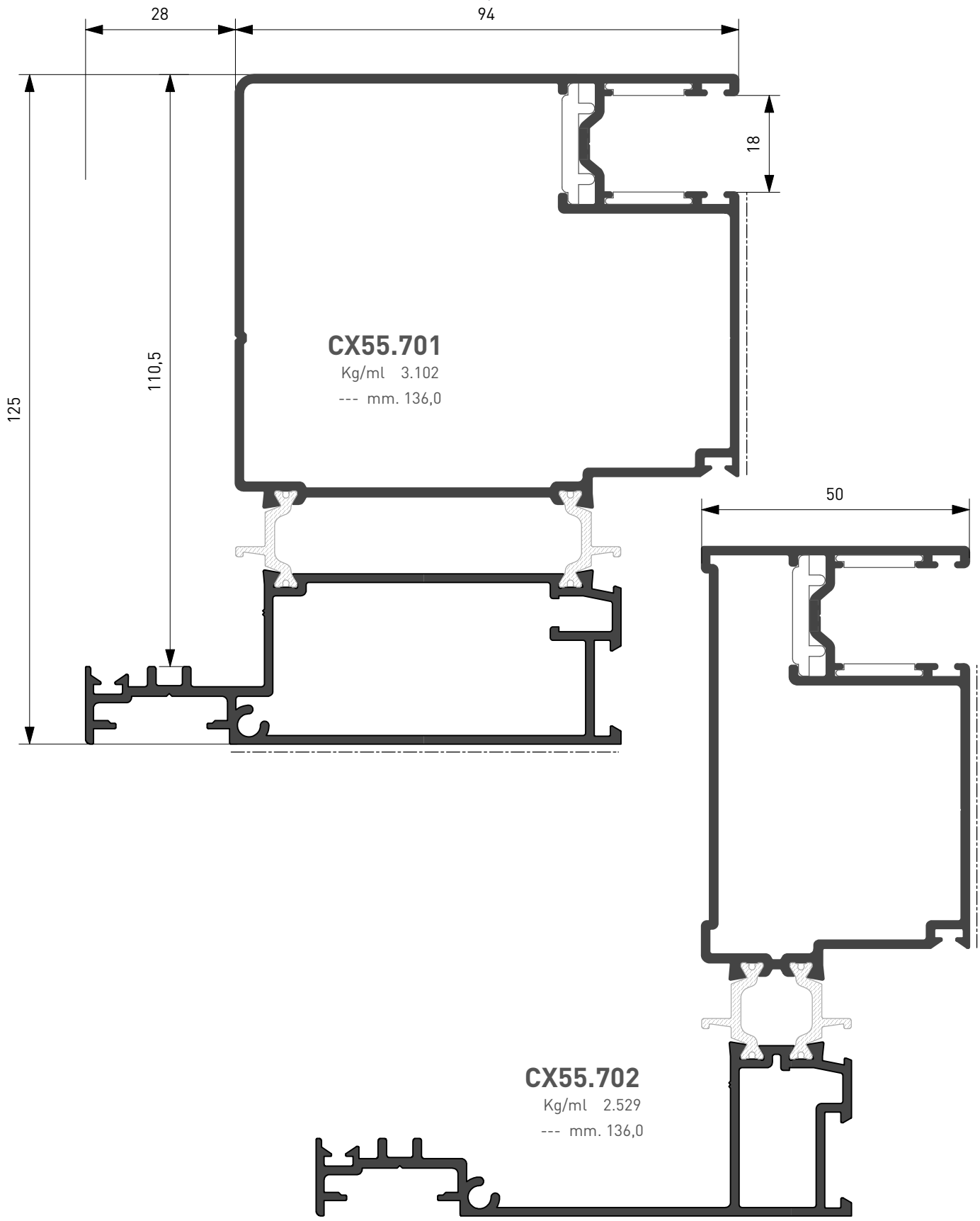

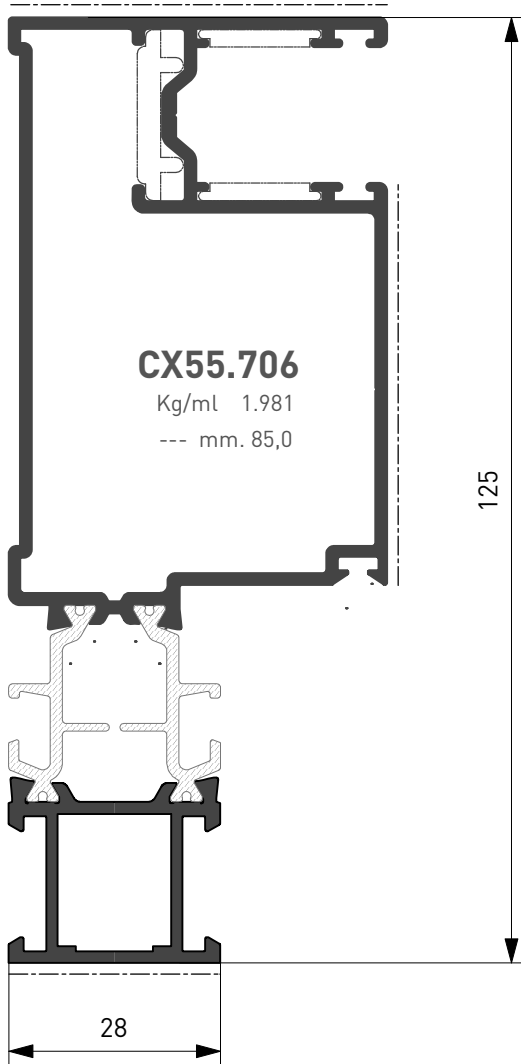

XX70.705
Kg/ml 0.155
--- mm. 000,0

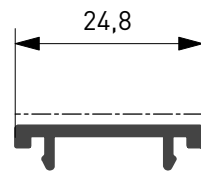

XX70.704
Kg/ml 0.135
--- mm. 25,0

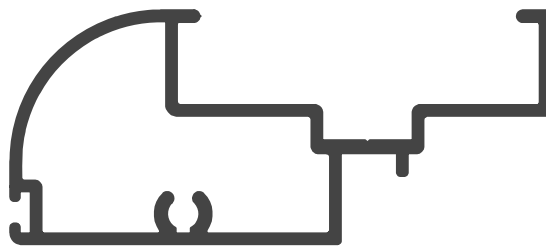

XX70.703
Kg/ml 0.791
--- mm. 43,0

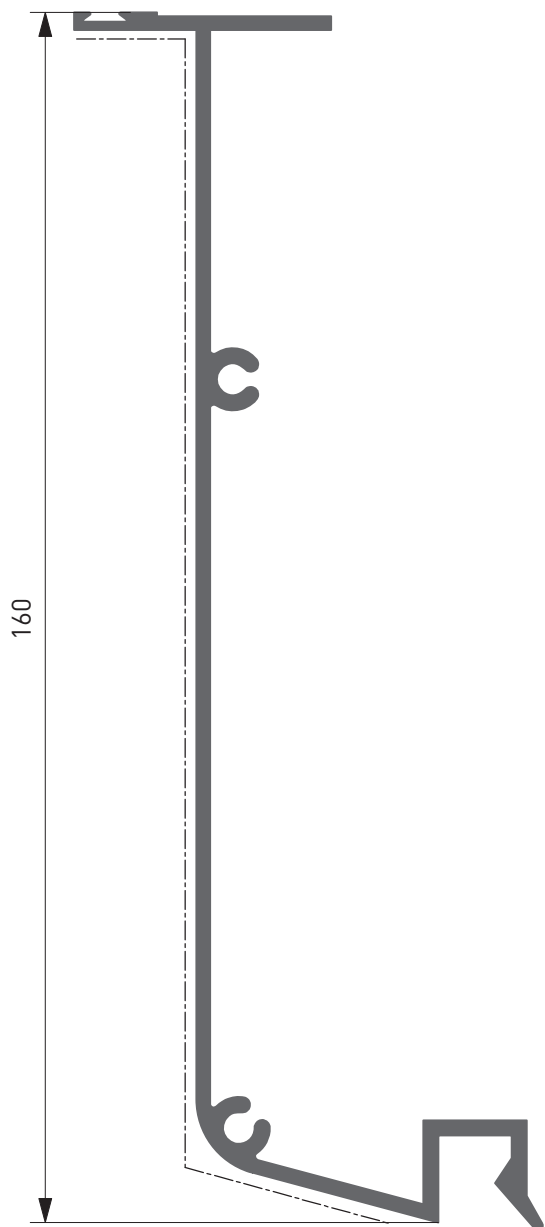

CX45.3363

Kg/ml 1.379

--- mm. 182,0

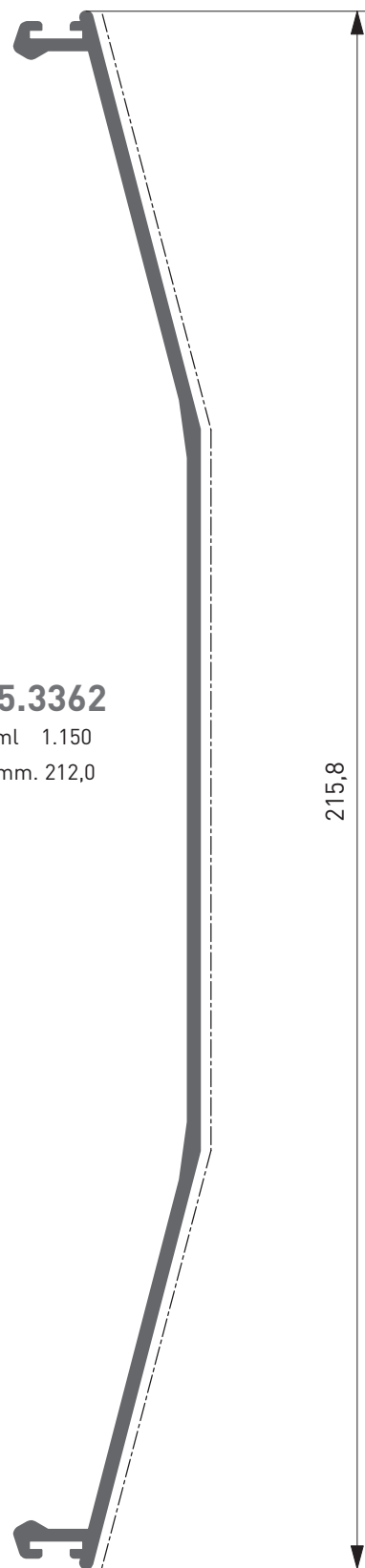

CX45.3362

Kg/ml 1.150

--- mm. 212,0

215,8

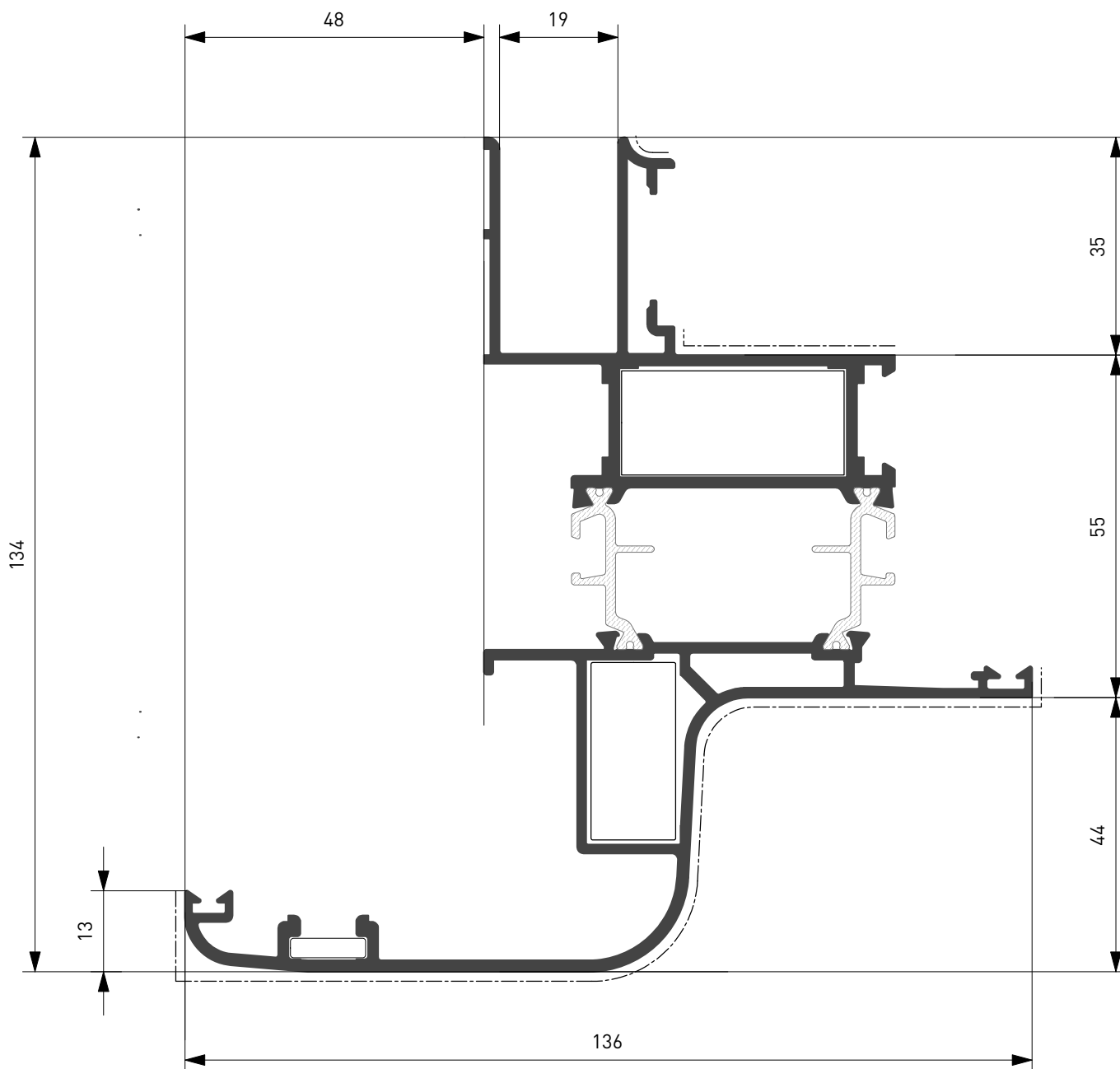

CX55.109

Kg/ml 2.890

--- mm. 242,0

Profilato Profile	Squadretta esterna External Corner Joint				Squadretta interna Internal Corner Joint							Sq. Allineamento Alining Corner J.			
	Cianfrinare Riveting		Spinare Crimping		Bottone Slot	Cianfrinare Riveting	Spinare Crimping	Avvitare Screw		Esterna External	Interna Internal				
CX55.109	ARX.01.SQ		ARX.02.SQ + ARX.07.SQ				AWX.17.SQ			ARX.15.SQ		ARX.10.SQ			

ATTENZIONE! per spinatura aggiungere anche LM0088 | Per avvitatura aggiungere anche VILM 5x14_D8
ATTENTION! For crimping add LM0088 | For screw add VILM 5x14_D8

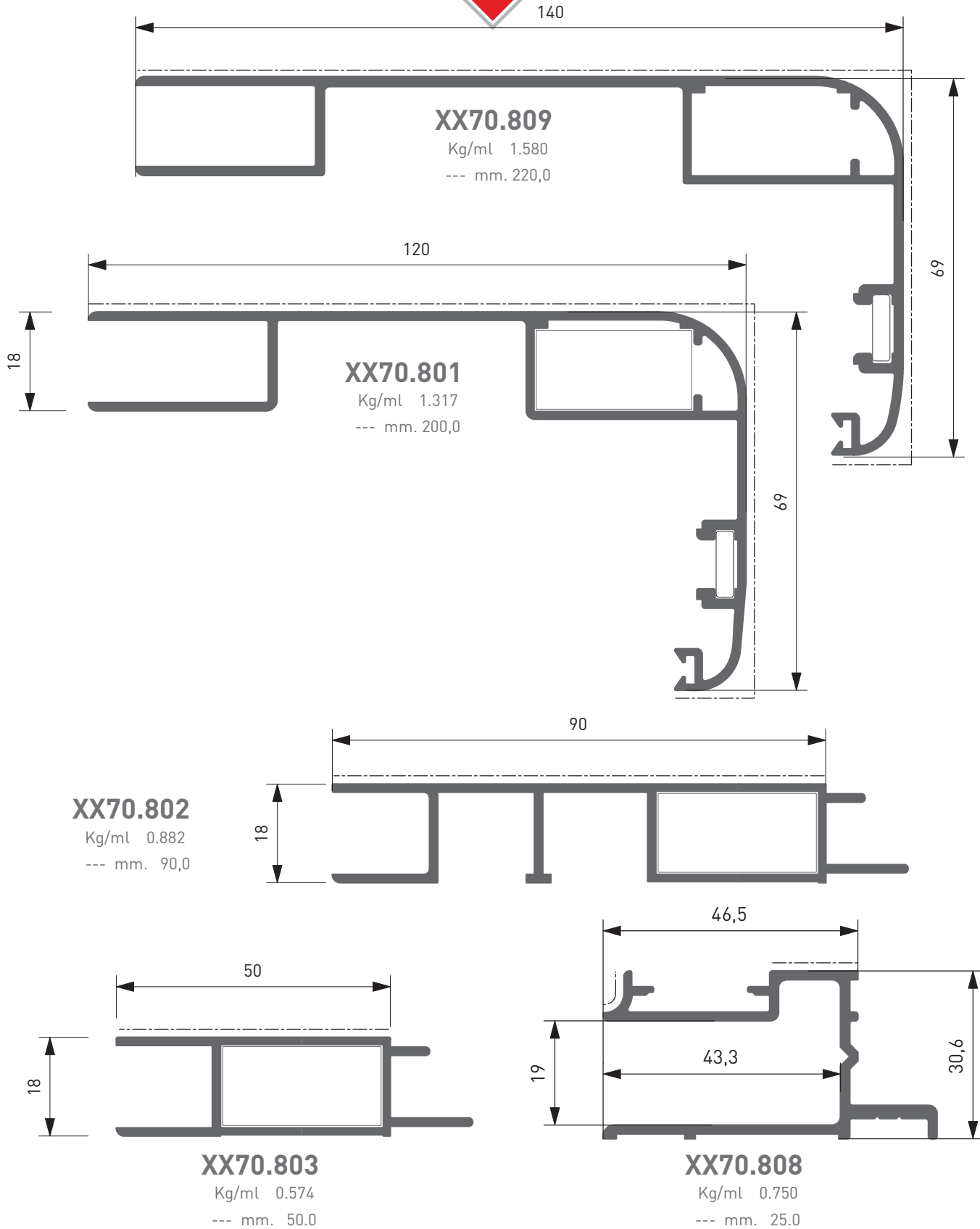

Profilato Profile	Squadretta esterna External Corner Joint				Squadretta interna Internal Corner Joint				Sq. Allineamento Alining Corner J.					
	Bottone	Slot	Spinare	Crimping	Bottone	Slot	Cianfrinare	Riveting	Spinare	Crimping	Esterna	External	Interna	Internal
XX70.801					ACX.01.SQ		ACX.02.SQ		ACX.02.SQ + ARX.07.SQ				ARX.11.SQ	
XX70.802					ACX.01.SQ		ACX.02.SQ		ACX.02.SQ + ARX.07.SQ					
XX70.803					ACX.01.SQ		ACX.02.SQ		ACX.02.SQ + ARX.07.SQ					
XX70.809					ACX.01.SQ		ACX.02.SQ		ACX.02.SQ + ARX.07.SQ				ARX.11.SQ	

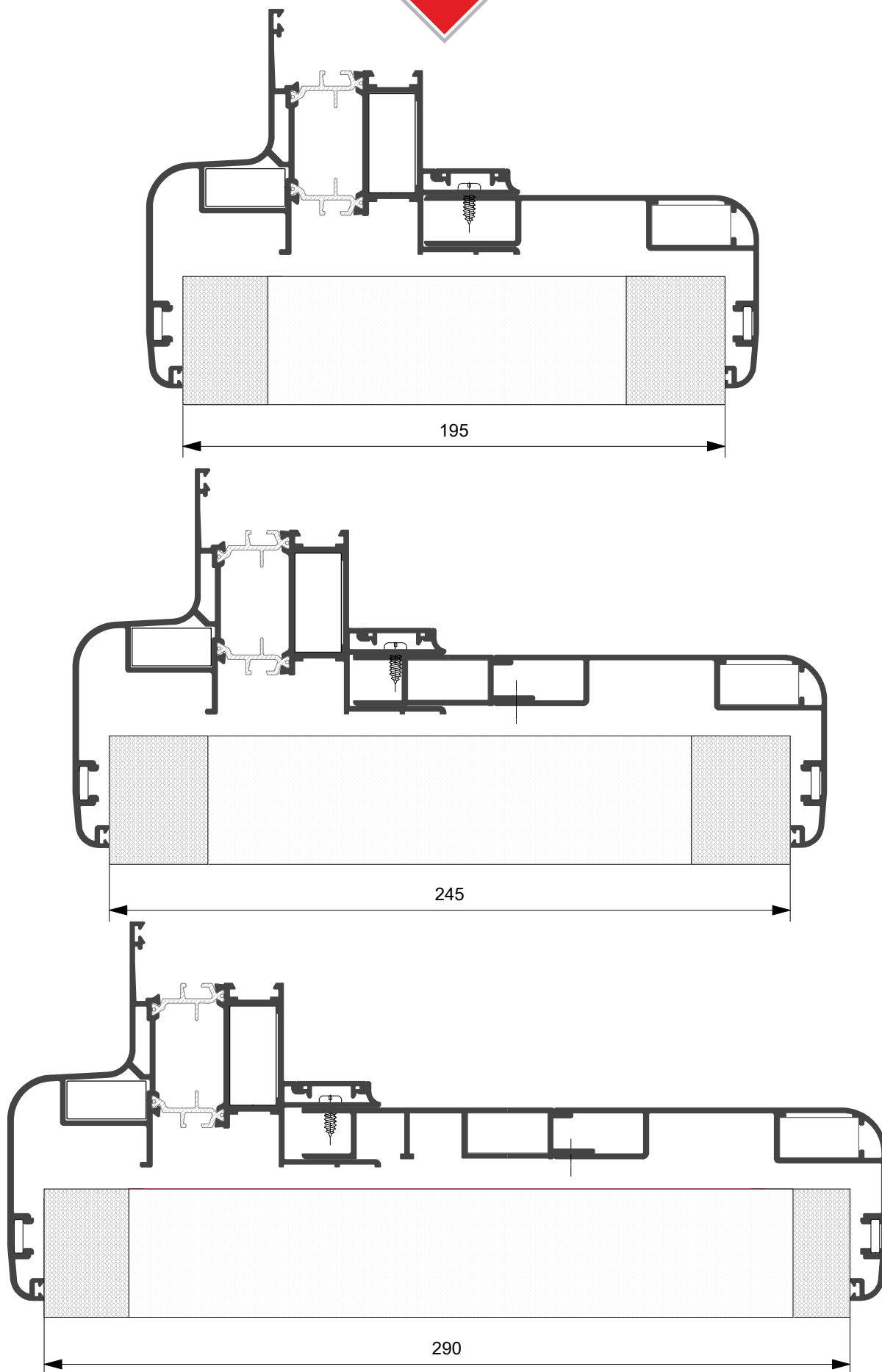



CX70.540

Kg/ml 0.2249
--- mm. 32,0

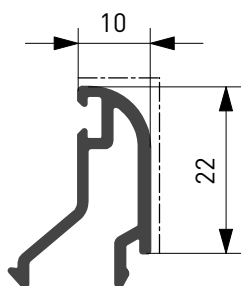

CX70.521

Kg/ml 0.266
--- mm. 36,0

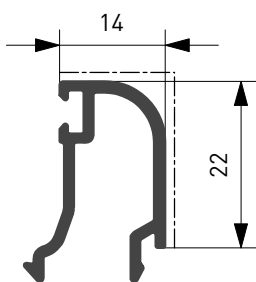

CX70.522

Kg/ml 0.277
--- mm. 40,0

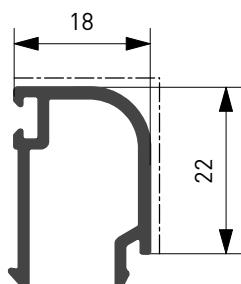

CX70.523

Kg/ml 0.294
--- mm. 44,0

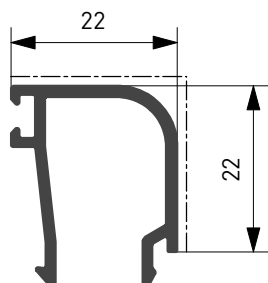

CX70.524

Kg/ml 0.314
--- mm. 48,0

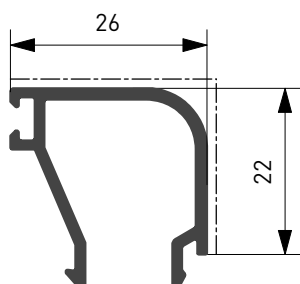

CX70.525

Kg/ml 0.350
--- mm. 52,0

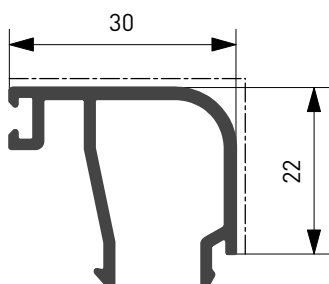

APPLICAZIONE FERMAVETRI TONDI
APPLICATION OF ROUND GLAZING BEADS

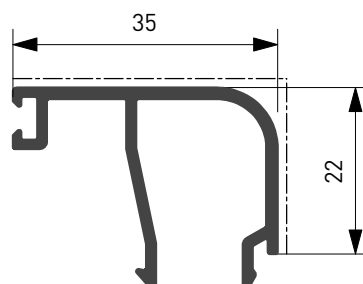
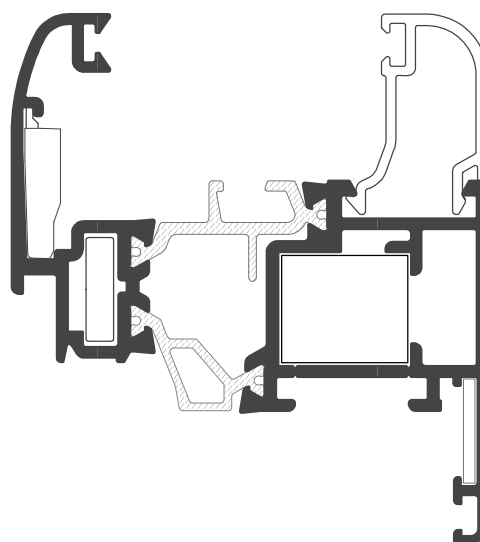

CX70.531

Kg/ml 0.370
--- mm. 57,0



CX70.533

Kg/ml 0.252
--- mm. 27,0

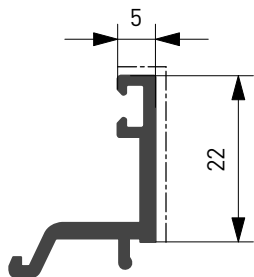

APPLICAZIONE FERMAVETRI DRITTI

APPLICATION OF STRAIGHT GLAZING BEADS

CX70.539

Kg/ml 0.245
--- mm. 27,0

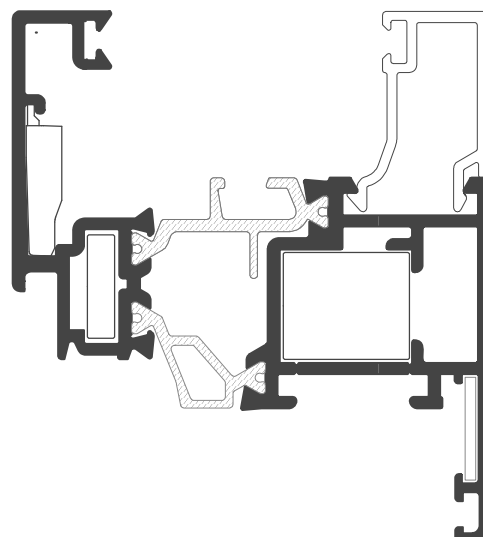
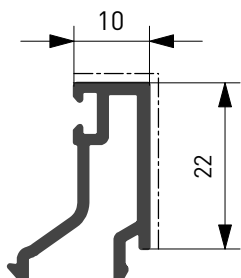

CX70.526

Kg/ml 0.279
--- mm. 36,0

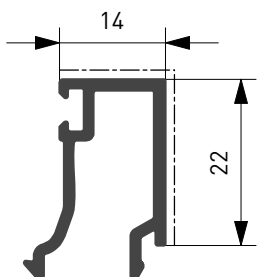

CX70.527

Kg/ml 0.290
--- mm. 40,0

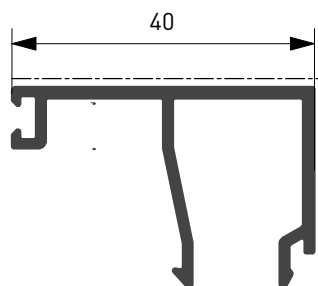
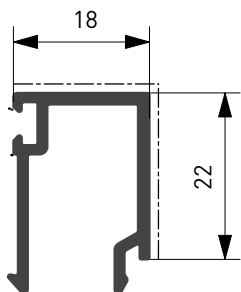

CX70.537

Kg/ml 0.403
--- mm. 62,0

CX70.528

Kg/ml 0.307
--- mm. 44,0

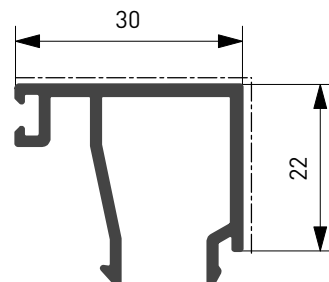
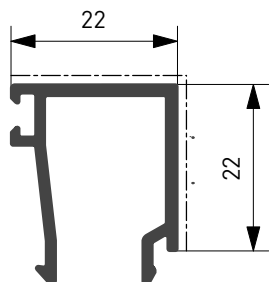

CX70.530

Kg/ml 0.362
--- mm. 52,0

CX70.529

Kg/ml 0.327
--- mm. 48,0

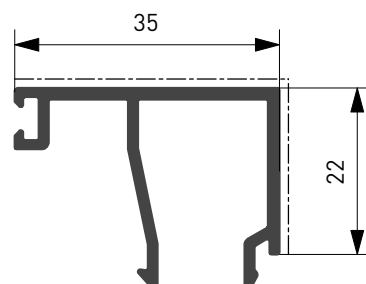
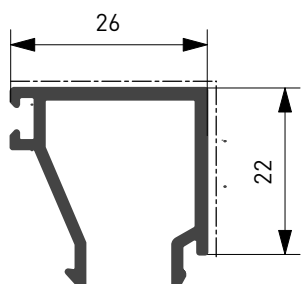

CX70.532

Kg/ml 0.383
--- mm. 57,0



CX70.571

Kg/ml 0.216
--- mm. 36,0

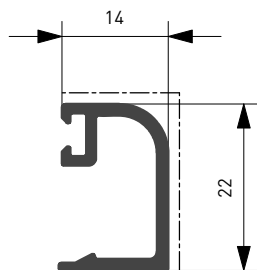

CX70.572

Kg/ml 0.262
--- mm. 40,0

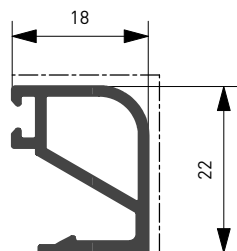

CX70.573

Kg/ml 0.283
--- mm. 44,0

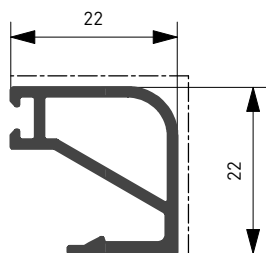

CX70.574

Kg/ml 0.313
--- mm. 48,0

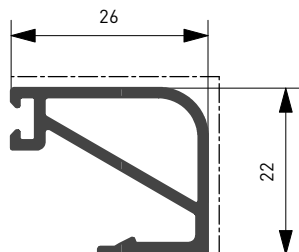

CX70.575

Kg/ml 0.340
--- mm. 52,0

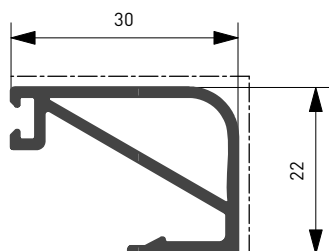

RX70.581

Kg/ml 0.361
--- mm. 57,0

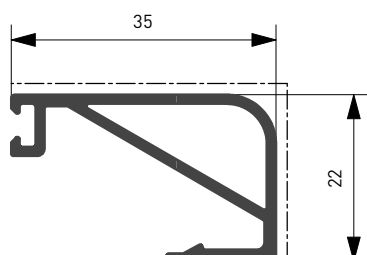

APPLICAZIONE FERMAVETRI C/CLIPS
APPLICATION OF GLAZING BEADS W/CLIPS

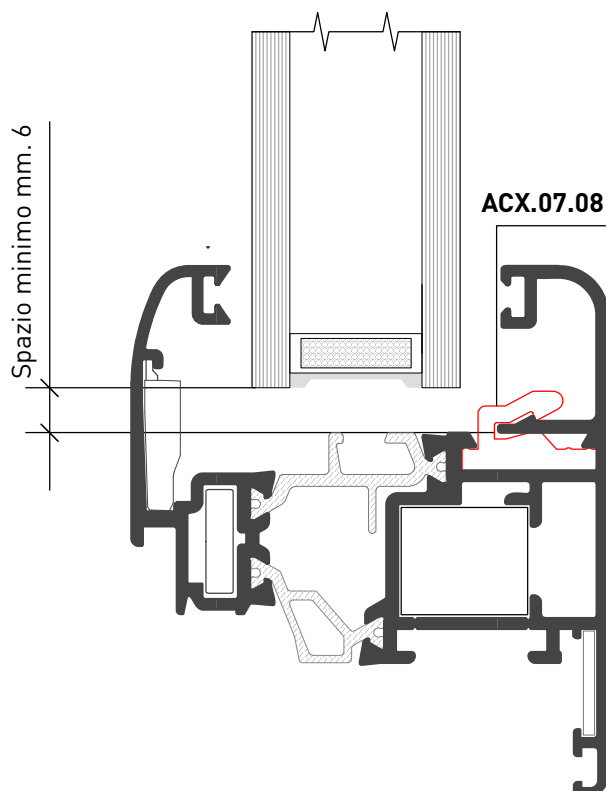

E' consigliabile l'abbinamento con fermavetri tradizionali tondi con taglio a 45°, al fine di evitare gli angoli fermavetro in zama

It is advisable to combine with traditional round glazing beads with a 45° cut, in order to avoid zamac glazing bead corners



CX70.568

Kg/ml 0.297
--- mm. 32,0

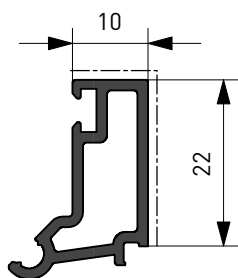

CX70.562

Kg/ml 0.324
--- mm. 36,0

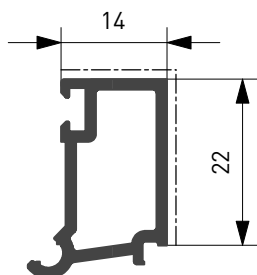

CX70.563

Kg/ml 0.330
--- mm. 40,0

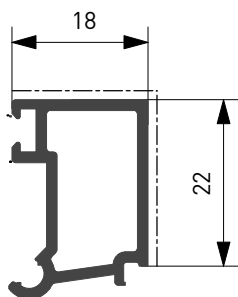

CX70.564

Kg/ml 0.348
--- mm. 44,0

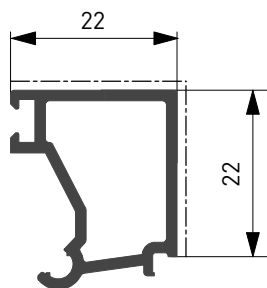

CX70.565

Kg/ml 0.372
--- mm. 48,0

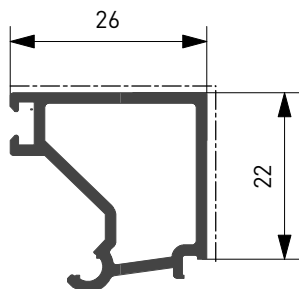

CX70.566

Kg/ml 0.396
--- mm. 52,0

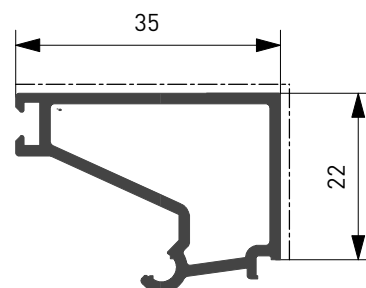
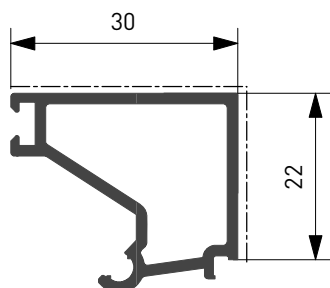

CX70.567

Kg/ml 0.434
--- mm. 57,0

APPLICAZIONE FERMAVETRI DI SICUREZZA
APPLICATION OF STRAIGHT SAFETY GLAZING BEADS



ATTENZIONE | ATTENTION

- UTILIZZARE UN PEZZO OGNI 300 mm. (min 2 Pz.)
- CONSIDERARE LA GUARNIZIONE INTERNA A ZEPPA Min. 4 mm.
- USE ONE PIECE EVERY 300 mm.
- CONSIDER THE INTERNAL WEDGE GASKET Min. 4 mm.

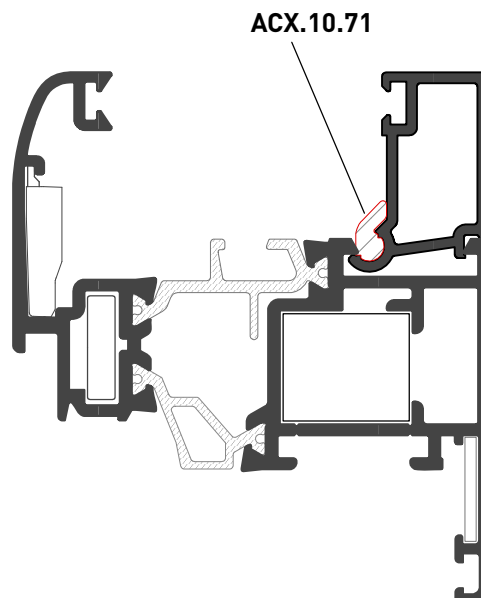



Aletta Flap (a) mm.	Vuoto Gap (v) mm.	Dim. Fermavetro Glazing Bead Size (f) mm.	CODICE Fermavetro Glazing Bead CODE		Guarnizione EXT EXT Gasket mm.	Guarnizioni INTERNE Vetro INTERNAL Glass Window Gaskets							
			D = Dritto Straight	T = Tondo Round		ARX.10.15		ARX.10.14		ARX.10.13		ARX.10.12	
						mm.10	mm.9	mm.8	mm.7	mm.6	mm.5	mm.4	mm.3
						Vetratura Glazing							
5	20	30	D	CX70.530	3	7	8	9	10	11	12	13	14
			T	CX70.525									
5	24	26	D	CX70.529	3	11	12	13	14	15	16	17	18
			T	CX70.524									
5	28	22	D	CX70.528	3	15	16	17	18	19	20	21	22
			T	CX70.523									
5	32	18	D	CX70.527	3	19	20	21	22	23	24	25	26
			T	CX70.522									
5	36	14	D	CX70.526	3	23	24	25	26	27	28	29	30
			T	CX70.521									
5	45	5	D	CX70.533	3	32	33	34	35	36	37	38	39
			T										

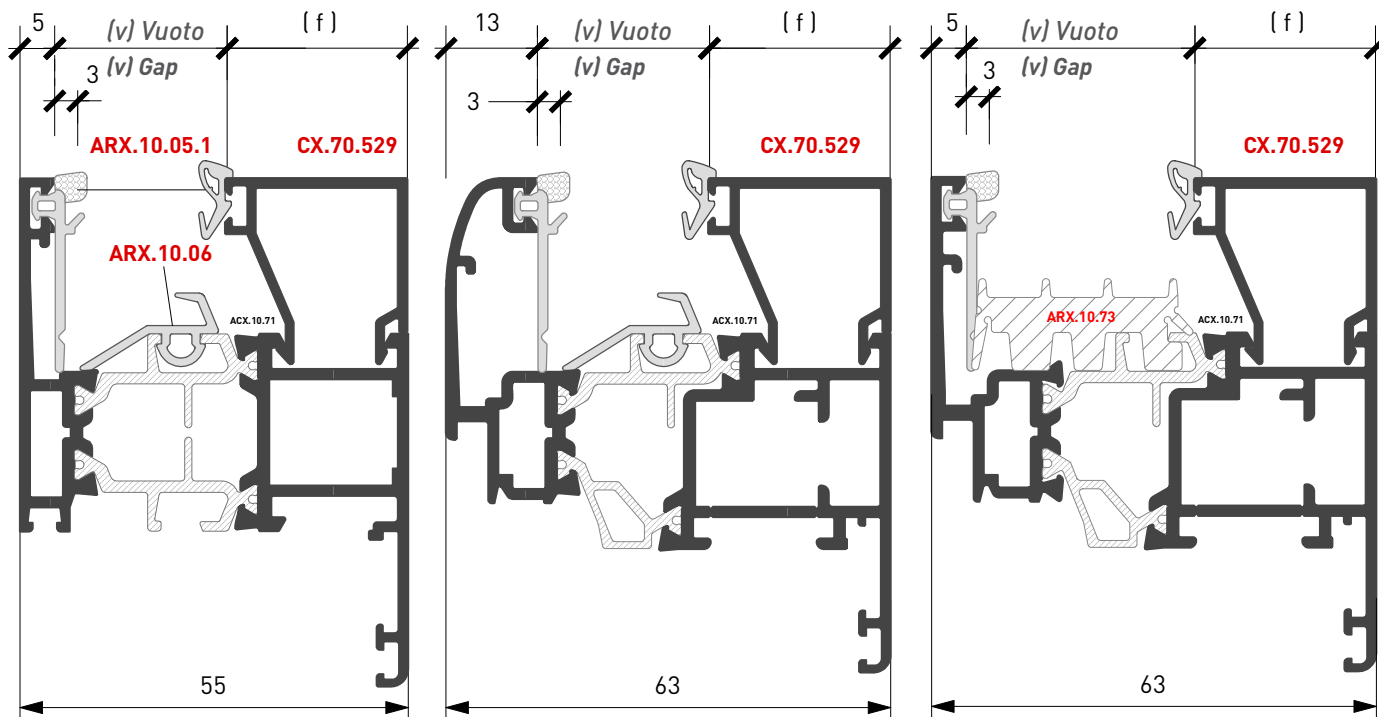

TASSELLI VETRO PER TIPOLOGIA
GLASS DOWELS FOR TYPE



ARX 07.09

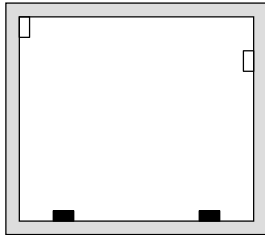

Telaio Fisso
Fixed Frame

Spessore 3 mm.

Spessore 2 mm.

Spessore 3 mm.

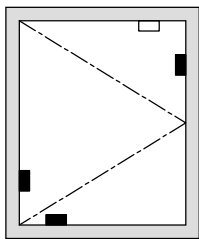
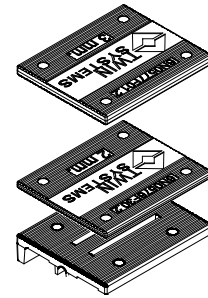

Anta Battente
Casement Window

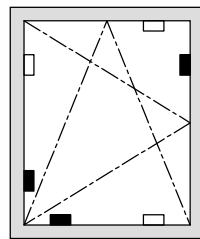

Anta Ribalta
Casement+Protruding Window

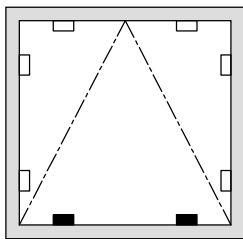

Wasistas
Protruding Window

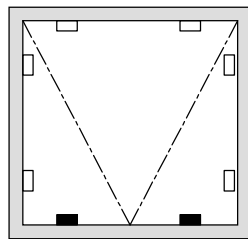

Sporgere
Transom Window

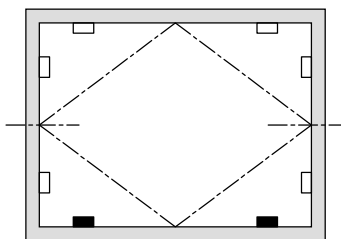
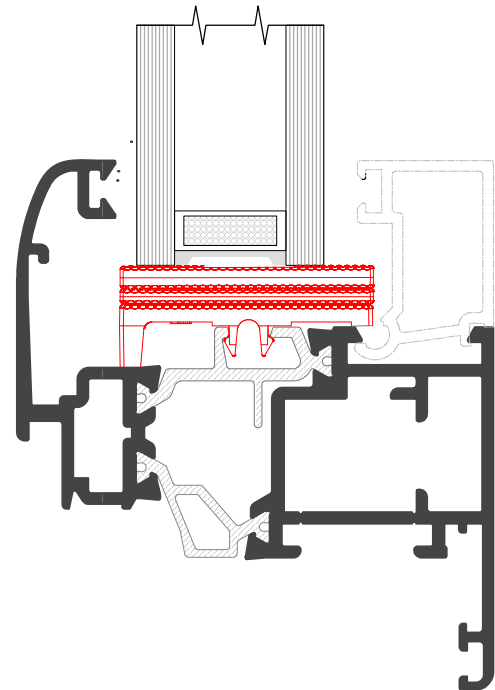

Bilico Orizzontale
Horizontal Pivoting Window

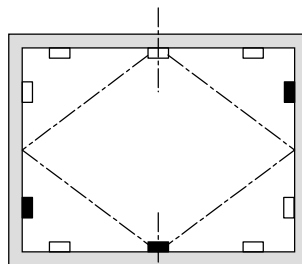

Bilico Verticale
Vertical Pivoting Window

TASSELLO di APPOGGO
SUPPORTING PLUG

TASSELLO PERIMETRALE
PERIMETER PLUG

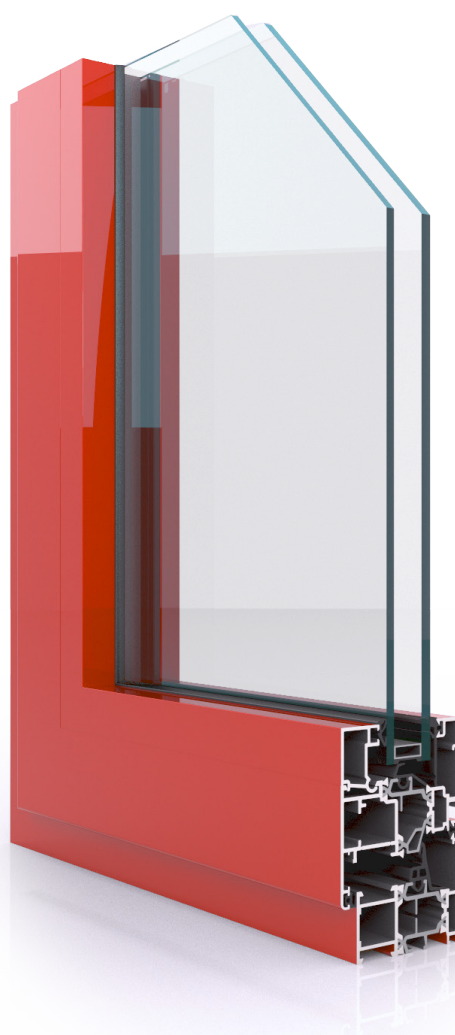

Accessori e Guarnizioni
Accessories and Gaskets

Gruppo **C**

Elenco accessori List of Accessories
Elenco guarnizioni List of Window Gaskets

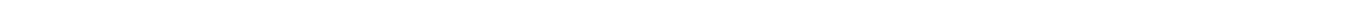



CODIFICA FINITURE SUPERFICIALI ACCESSORI

ACCESSORIES SURFACE FINISHING CODES

In fase di ordine aggiungere agli accessori, se previste, le seguenti codifiche superficiali:
When ordering, add the following surface codes to the accessories listed below, where applicable:

<i>DESCRIPTION</i>	CODICE CODE	DESCRIZIONE
<i>PAINTED MATT BLACK</i>	NEOPA	VERNICIATO NERO OPACO
<i>WHITE</i>	R 9 0 1 0	VERNICIATO BIANCO
<i>IVORY</i>	R 1 0 1 3	VERNICIATO AVORIO
<i>GREEN</i>	R 6 0 0 5	VERNICIATO VERDE
<i>BLACK</i>	R 9 0 0 5	VERNICIATO NERO LUCIDO
<i>BROWN</i>	R 8 0 1 7	VERNICIATO MARRONE
<i>GOTHIC GREEN</i>	G 6 3 6 0	VERNICIATO VERDE GOTICO
<i>GOTHIC GREY</i>	G 9 4 2 0	VERNICIATO GRIGIO GOTICO
<i>GOTHIC BROWN</i>	G 3 9 7 6	VERNICIATO MARRONE GOTICO
<i>SILVER</i>	V E A R	VERNICIATO ARGENTO
<i>WITHERED MOSS</i>	V S C R A	VERDE SCURO RAGGRINZITO
<i>FALLOW</i>	M A R A G	MARRONE RAGGRINZITO
<i>GOLDFINISH GUNMETAL GRAY</i>	K A N F U	CANNA DI FUCILE GOLDFINISH
<i>GOLDFINISH COPPER</i>	K R A M E	RAME GOLDFINISH
<i>GOLDFINISH POLISHED</i>	K I N O X	INOX LUCIDO GOLDFINISH
<i>GOLDFINISH SATIN-FINISH STAINLESS STEEL</i>	K S A T I	INOX SATINATO GOLDFINISH
<i>GOLDFINISH GOLD</i>	K G O L D	GOLD GOLDFINISH
<i>GOLDFINISH ANTIQUE BRASS</i>	K A N T I C	OTTONE ANTICO GOLDFINISH
<i>NEW SILVER</i>	A R G E N T	NEW ARGENTO
<i>NEW BRONZE</i>	B R O N Z	NEW BRONZO

ESEMPIO

ACX 02.01 | **R 9010**

EXAMPLE

Cerniera Verniciata | COLORE Bianco Ral 9010
Painted Hinge | COLOUR White RAL 9010



SQUADRETTE

Corner Joints

<p>ARX.03.SQ</p> <p>Descrizione <i>Description</i> Squadretta cianfrinare/spinare <i>Riveting/crimping corner joint</i> (4.3 mm. x 14 mm.)</p>		<p>AWX.17.SQ</p> <p>Descrizione <i>Description</i> Squadretta avvitare/cianfrinare/spinare <i>Screwing/Riveting/crimping corner joint</i> (17.5 mm. x 35.8 mm.)</p>	 <p>VIL M5X14_D8 Vite per squadretta <i>Corner Joint Screw</i></p>
<p>ARX.06.SQ</p> <p>(4.3 mm. x 39.1 mm.)</p>	 <p>Squadretta cianfrinare/spinare <i>Riveting/crimping corner joint</i></p>	<p>ARX.19.SQ</p> <p>Descrizione <i>Description</i> Squadretta avvitare/cianfrinare/spinare <i>Screwing/Riveting/crimping corner joint</i> (17.5 mm. x 15 mm.)</p>	 <p>VIL M5X14_D8 Vite per squadretta <i>Corner Joint Screw</i></p>
<p>ARX.18.SQ</p> <p>(4.3 mm. x 26.3 mm.)</p>		<p>ARX.24.SQ</p> <p>Descrizione <i>Description</i> Squadretta allineamento esterna <i>External Alining Corner Joint</i></p>	
<p>ARX.07.SQ</p> <p>Spina per ACX.02.SQ e ACX.14.SQ <i>Plug</i></p>		<p>ARX.47.SQ</p> <p>Descrizione <i>Description</i> Cavallotto EXTc/fermavetri dritti nessuna lavorazione <i>External U-bolt w/straight glazing bead</i> (portata 350 kg.)</p>	
<p>ARX.08.SQ</p> <p>Spina per ACX.03.SQ e ACX.06.SQ <i>Plug</i></p>		<p>ARX.48.SQ</p> <p>Descrizione <i>Description</i> Squadretta angolo variabile <i>Variable corner joint</i> (16.8 mm. x 14.3 mm.)</p>	 <p>dx - sx L - R</p>
<p>ARX.10.SQ</p> <p>Descrizione <i>Description</i> Squadretta allineamento interna <i>Internal Alining Corner Joint</i></p>		<p>ARX.11.SQ</p> <p>Descrizione <i>Description</i> Squadretta allineamento EXT <i>External Alining Corner Joint</i> XX70.801 e RX60.109</p>	
<p>ARX.13.SQ</p> <p>Descrizione <i>Description</i> Squadretta a pulsante <i>Slot corner joint</i> (23.5 mm. x 14.5 mm.)</p>		<p>ARX.14.SQ</p> <p>Descrizione <i>Description</i> Squadretta cianfrinare/spinare/avvitare <i>Riveting/crimping corner joint</i> (28.5 mm. x 35.8 mm.)</p>	<p>VIL M5X14_D8</p> <p>Descrizione <i>Description</i> Vite per squadretta <i>Screw for bracket</i> AWX.17.SQ e AWX.19.SQ</p> 
<p>ARX.15.SQ</p> <p>Descrizione <i>Description</i> Squad. allineamento EXT tiraggio meccanico <i>External alining corner joint</i> <i>mechanical draught</i></p>		<p>ARX.01.SQ</p> <p>Descrizione <i>Description</i> Squadretta a pulsante <i>Slot corner joint</i> (28.5 mm. x 14.5 mm.)</p>	 <p>ACX.63.SQ</p> <p>Descrizione <i>Description</i> Giunzione a "T" o a "Croce" <i>"T" Joint</i> Foro Hole 8 mm.</p> 
<p>ACX.16.SQ</p> <p>Descrizione <i>Description</i> Squadretta a pulsante <i>Slot Corner Joint</i> (17.5 mm. x 15 mm.) Pulsante (Button) 8 mm.</p>		<p>ACX.64.SQ</p> <p>Descrizione <i>Description</i> Giunzione a "T" o a "Croce" per profili Maggiorati <i>"T" or "Cross" Joint for Oversize Profiles</i> Foro Hole 8 mm.</p>	



Cerniere
Hinges

<p>ACX.02.01</p> <p>Descrizione <i>Description</i> Cerniera a montaggio rapido preassemblata a 2 ali <i>Rapid-assembly pre-assembled 2-leafed hinge</i></p>		<p>ACX.02.10</p> <p>Descrizione <i>Description</i> Cerniera a compasso <i>Compass Hinge</i></p>	
<p>ACX.02.02</p> <p>Descrizione <i>Description</i> Cerniera a montaggio rapido preassemblata a 2 ali per 3° anta <i>Rapid-assembly pre-assembled 2-leafed hinge for 3rd Sash</i></p>		<p>ACX.02.10P</p> <p>Descrizione <i>Description</i> Cerniera Scomparsa <i>Concealed Hinge</i> Battente/Casement 40 kg Sporgere/Projection 120 kg Wasistas/Hopper Window 120 kg</p>	
<p>ACX.02.03</p> <p>Descrizione <i>Description</i> Cerniera a montaggio rapido preassemblata a 3 ali <i>Rapid-assembly pre-assembled 3-leafed hinge</i></p>		<p>ACX.02.11</p> <p>Descrizione <i>Description</i> Cerniera a 2 ali per porte con piastrina ad infilare <i>2-leafed hinge for doors with plate to insert</i></p>	
<p>ACX.02.04</p> <p>Descrizione <i>Description</i> Cerniera a montaggio rapido preassemblata a 3 ali per 3° anta <i>Rapid-assembly pre-assembled 3-leafed hinge for 3rd Sash</i></p>		<p>ARX.02.12</p> <p>Descrizione <i>Description</i> Cerniera per Porta EXT 2 Ali <i>2-leafed hinge for external doors</i> Interasse/Center Dist.= 67 mm.</p>	
<p>ACX.02.05</p> <p>Descrizione <i>Description</i> Cerniera per vasistas apertura singola 30° <i>Hinge for single opening hopper window 30°</i></p>		<p>ARX.02.13</p> <p>Descrizione <i>Description</i> Cerniera per Porta EXT 3 Ali <i>3-leafed hinge for external doors</i> Interasse/Center Dist.= 67 mm.</p>	
<p>ACX.02.06</p> <p>Descrizione <i>Description</i> Cerniera per vasistas apertura doppia 30° e 75° <i>Hinge for double opening hopper window 30°/75°</i></p>		<p>ARX.02.14</p> <p>Descrizione <i>Description</i> Cerniera per Porta EXT 2 Ali <i>2-leafed hinge for external doors</i> Interasse/Center Dist.= 93 mm.</p>	
<p>ACX.02.07</p> <p>Descrizione <i>Description</i> Braccio lungo per vasistas <i>Long arm for hopper window</i> Anta/Sash=600/1600 mm.</p>		<p>ARX.02.15</p> <p>Descrizione <i>Description</i> Cerniera per Porta EXT 3 Ali <i>3-leafed hinge for external doors</i> Interasse/Center Dist.= 93 mm.</p>	
<p>ACX.02.08</p> <p>Descrizione <i>Description</i> Braccio corto per vasistas <i>Short arm for hopper window</i> Anta/Sash=280/800 mm.</p>		<p>ARX.02.16</p> <p>Descrizione <i>Description</i> Spessore per Cerniera Porta EXT <i>Spacer for EXT Door Hinge</i> Spessore/Thickness= 8 mm.</p>	
<p>ACX.02.09</p> <p>Descrizione <i>Description</i> Braccio telescopico per vasistas a scatto <i>Telescopic arm for snap-fit hopper window</i></p>		<p>ARX.02.17</p> <p>Descrizione <i>Description</i> Cerniera per scuretto <i>Hinge for Shutter</i></p>	



<p>ARX.02.21</p> <p>Descrizione <i>Description</i> Kit Contropiastrine cerniere 2 Ali <i>2-leafed hinge strike plates kit</i></p>		<p>ASX.03.03</p> <p>Descrizione <i>Description</i> Martellina Doppia <i>Double Martellina Handle</i></p> <p>COMFORT</p>	
<p>ARX.02.22</p> <p>Descrizione <i>Description</i> Kit Contropiastrine cerniere 3 Ali <i>3-leafed hinge strike plates kit</i></p>		<p>ARX.03.04</p> <p>Descrizione <i>Description</i> Martellina <i>MARTELLINA Handle</i></p> <p>Sporg. Quadro/Rosette Projection=24 mm.</p>	
<p>ARX.02.24</p> <p>Descrizione <i>Description</i> Viti di Fissaggio cerniere <i>Hinge Fixing Screws</i></p>		<p>ARX.03.05</p> <p>Descrizione <i>Description</i> Martellina con chiave <i>MARTELLINA Handle w/Key</i></p> <p>Sporg. Quadro/Rosette Projection=24 mm.</p>	
<p>ARX.02.25</p> <p>Descrizione <i>Description</i> Kit gradino <i>Step KIT</i></p>		<p>ARX.03.05LDX</p> <p>Descrizione <i>Description</i> RIGHT MARTELLINA Handle LOGICA</p> <p>Sporg. Quadro/Rosette Projection=24 mm.</p>	
<p>ARX.02.36</p> <p>Descrizione <i>Description</i> Perni fissaggio cerniere <i>Hinge Fixing Pins</i></p> <p>53 mm.</p>		<p>ARX.03.05LSX</p> <p>Descrizione <i>Description</i> Martellina LOGICA sx <i>LEFT MARTELLINA Handle LOGICA</i></p> <p>Sporg. Quadro/Rosette Projection=24 mm.</p>	
<p>ARX.02.37</p> <p>Descrizione <i>Description</i> Regolatore in altezza <i>Height Adjuster</i></p> <p>Cerniere/Hinges=ARX.02.11</p>		<p>ARX.03.06</p> <p>Descrizione <i>Description</i> Cremonese <i>CREMONESE Handle</i></p> <p>Interasse/Center Dist.=84/92/104 mm.</p>	
<p>ACX.03.01</p> <p>Descrizione <i>Description</i> Cricchetto in alluminio Fissaggio Con Piastrine <i>Plate fixing aluminium ratchet</i></p>		<p>ARX.03.07</p> <p>Descrizione <i>Description</i> Cremonese con chiave <i>CREMONESE Handle w/Key</i></p> <p>Interasse/Center Dist.=84/92/104 mm.</p>	
<p>ARX.03.02</p> <p>Descrizione <i>Description</i> Maniglia a Tavellino <i>Tavellino HANDLE</i></p>		<p>ARX.03.07LDX</p> <p>Descrizione <i>Description</i> Cremonese LOGICA dx <i>RIGHT CREMONESE Handle LOGICA</i></p> <p>Interasse/Center Dist.=84/92/104 mm.</p>	
<p>ARX.03.03</p> <p>Descrizione <i>Description</i> Maniglia Doppia <i>Double Hinge</i></p>		<p>ARX.03.07LSX</p> <p>Descrizione <i>Description</i> Cremonese LOGICA sx <i>LE CREMONESE Handle LOGICA</i></p> <p>Interasse/Center Dist.=84/92/104 mm.</p>	



<p>ARX.03.08</p> <p>Descrizione <i>Description</i> Cremonese per Anta Ribalta <i>Cremonese for Awning Window</i></p>		<p>ACX.03.18</p> <p>Descrizione <i>Description</i> Terminali astina <i>Bar Terminals</i></p>	
<p>ARX.03.09</p> <p>Descrizione <i>Description</i> Movimentazione Bidirezionale <i>Bi-directional movement</i></p> <p>Interasse/Center Dist.=15/27 mm.</p>		<p>ACX.03.19</p> <p>Descrizione <i>Description</i> Sostegno anta <i>Sash Support</i></p>	
<p>ACX.03.10</p> <p>Descrizione <i>Description</i> Movimentazione Unidirezionale per Anta Ribalta <i>Unidirectional movement for Awning Window</i></p>		<p>ARX.03.22</p> <p>Descrizione <i>Description</i> Kit Fast Out chiusura apert. EXT <i>Fast Out EXT Open/Close</i> L=1000 mm. (3 punti) E=35 mm.</p>	
<p>ACX.03.11</p> <p>Descrizione <i>Description</i> Catenacciolo a Leva <i>Lever bolt</i></p>		<p>ARX.03.23</p> <p>Descrizione <i>Description</i> Kit Fast Out chiusura apert. EXT <i>Fast Out EXT Open/Close</i> L=600 mm. (2 punti) E=35 mm.</p>	
<p>ACX.03.12</p> <p>Descrizione <i>Description</i> Terminale asta <i>Bar Terminal</i></p>		<p>ARX.03.24</p> <p>Descrizione <i>Description</i> Kit Fast Out chiusura apert. EXT <i>Fast Out EXT Open/Close</i> L=1600 mm. (3 punti) E=35 mm.</p>	
<p>ACX.03.14</p> <p>Descrizione <i>Description</i> Incontro Asta Doppio <i>Double Bar Rest Plate</i></p>		<p>ACX.03.25</p> <p>Descrizione <i>Description</i> Kit Fast Out chiusura apert. EXT <i>Fast Out EXT Open/Close</i></p> <p>art. ACX.03.22</p>	
<p>ACX.03.15</p> <p>Descrizione <i>Description</i> Ferma Anta <i>Door Stop</i></p>		<p>ACX.03.26</p> <p>Descrizione <i>Description</i> Kit Fast Out chiusura apert. EXT <i>Fast Out EXT Open/Close</i></p> <p>art. ACX.03.23</p>	
<p>ACX.03.16</p> <p>Descrizione <i>Description</i> Perno di chiusura supplementare regolabile <i>Supplementary adjustable closing pin</i></p>		<p>ACX.03.27</p> <p>Descrizione <i>Description</i> Kit Fast Out chiusura apert. EXT <i>Fast Out EXT Open/Close</i></p> <p>art. ACX.03.24</p>	
<p>ACX.03.17</p> <p>Descrizione <i>Description</i> Innesti Cremonese <i>CREMONESE Connections</i></p>		<p>ARX.03.28</p> <p>Descrizione <i>Description</i> Martellina per Fast Out <i>FAST OUT MARTELLINA</i></p> <p>Sporg. Quadro/Rosette Projection= 64 mm.</p>	





<p>ACX.03.29</p> <p>Descrizione <i>Description</i> Rostrò chiusura supplementare <i>Supplementary closing bolt</i></p>		<p>ACX.03.54</p> <p>Descrizione <i>Description</i> Sirio terminale asta c/Puntale [Ottone] <i>SIRIO Bar Terminal w/Tip [Brass]</i></p> <p>Decentr DX Off Center R \varnothing 8 mm.</p>	
<p>ARX.03.30</p> <p>Descrizione <i>Description</i> Tavellino per profilo scuretto <i>Latch for Shutter</i></p>		<p>ACX.03.55</p> <p>Descrizione <i>Description</i> Sirio terminale asta c/Puntale [Ottone] <i>SIRIO Bar Terminal w/Tip [Brass]</i></p> <p>Decentr SX Off Center R \varnothing 8 mm.</p>	
<p>ACX.03.43</p> <p>Descrizione <i>Description</i> Astina in poliammide <i>POLYAMIDE Bar</i></p>		<p>ACX.03.56</p> <p>Descrizione <i>Description</i> Sirio terminale asta c/Puntale [Ottone] <i>SIRIO Bar Terminal w/Tip [Brass]</i></p> <p>\varnothing 8 mm.</p>	
<p>ARX.03.45</p> <p>Descrizione <i>Description</i> Perno trascinamento <i>Winding Pivot</i></p>		<p>ACX.03.57</p> <p>Descrizione <i>Description</i> Cremonese ITALIA <i>CREMONESE Italia Bolt In</i></p> <p>Interasse/Center Dist.=84.5/104 mm.</p>	
<p>ARX.03.46</p> <p>Descrizione <i>Description</i> Cremonese con chiave <i>CREMONESE Handle w/cylinder Lock</i></p>		<p>ACX.03.58</p> <p>Descrizione <i>Description</i> ANTIEFFRAZIONE Antibreakage Kit base per Chiusura <i>Closing Accessories Base Kit</i></p>	
<p>ARX.03.48</p> <p>Descrizione <i>Description</i> Cremonese apertura EXT c/chave <i>CREMONESE Handle EXT Op. w/cylinder Lock</i></p>		<p>ACX.03.59</p> <p>Descrizione <i>Description</i> Cremonese ITALIA per AR con anti falsa manovra <i>for AR wrong counter-actuation</i></p>	
<p>ARX.03.50</p> <p>Descrizione <i>Description</i> Cremonese apertura EXT <i>CREMONESE Handle EXT Opening</i></p>		<p>ACX.03.60</p> <p>Descrizione <i>Description</i> ANTIEFFRAZIONE Antibreakage Punto chiusura / Closure Point</p> <p>Lav Astina Tonda Round Bar Tooling \varnothing 8 mm.</p>	
<p>ACX.03.52</p> <p>Descrizione <i>Description</i> ANTIEFFRAZIONE Antibreakage Braccio Chiusura <i>Closure Arm</i></p>		<p>ACX.03.61</p> <p>Descrizione <i>Description</i> ANTIEFFRAZIONE Antibreakage Chiusura Sist. sicurezza connessione Astina <i>Bar Connection Safety System</i></p>	
<p>ACX.03.53</p> <p>Descrizione <i>Description</i> Maniglia Italia Scatto per microventilazione <i>Microventilation Click</i></p>		<p>ACX.03.62</p> <p>Descrizione <i>Description</i> Incontro a pozzetto Puntale <i>Drain Rest Plate Tooling for Tip</i></p> <p>\varnothing 6 mm.</p>	





<p>ACX.03.63</p> <p>Descrizione <i>Description</i> Incontro a pozzetto <i>Drain Rest Plate</i></p> <p>per puntale \varnothing 6 mm.</p>		<p>ACX.03.73</p> <p>Descrizione <i>Description</i> Martellina ridotta <i>Reduced Martellina handle</i></p>	<p>“COMFORT MINI”</p> 
<p>ACX.03.64</p> <p>Descrizione <i>Description</i> Corpo di manovra a leva <i>Lever Manoeuvring Body</i></p> <p>“Mini tex.”</p>		<p>ACX.03.74</p> <p>Descrizione <i>Description</i> Martellina ridotta con cilindro <i>Reduced Martellina handle W/Cylinder</i></p>	<p>Sporg Quadro Rosette Projection 70 mm.</p> 
<p>ACX.03.65</p> <p>Descrizione <i>Description</i> Catenaccio a leva Bidirezionale <i>Bidirectional lever bolt</i></p> <p>“bi-hid” kit</p>		<p>ACX.04.51</p> <p>Descrizione <i>Description</i> Ripporto Tondo/Dritto <i>Round Straight Wing</i> Tappo Ripporto Giunto Aperto <i>Open Coupling Wing Cap</i></p>	
<p>ACX.03.66 L=11 mm.</p> <p>ACX.03.67 L=27 mm.</p> <p>Descrizione <i>Description</i> Perno di trascinamento <i>Winding Pivot</i></p>		<p>ACX.04.52</p> <p>Descrizione <i>Description</i> Ripporto Tondo/Dritto <i>Round Straight Wing</i> Tappo Ripporto Ferramenta Nastro <i>Tape Hardware Wing Cap</i></p>	
<p>ACX.04.63</p> <p>Descrizione <i>Description</i> Clip per XX70.503 <i>Clip for XX70.503</i></p>		<p>ACX.04.53</p> <p>Descrizione <i>Description</i> Ripporto Tondo/Dritto <i>Round Straight Wing</i> Tappo Ripporto Doppia Battua <i>Double Gasket Wing Cap</i></p>	
<p>ACX.03.68</p> <p>Descrizione <i>Description</i> Doppia maniglia “Comfort mini” <i>Double Handle “Comfort MINI”</i></p>		<p>ARX.04.30</p> <p>Descrizione <i>Description</i> Tappo a L battuta inferiore porte <i>L-shaped cap Bottom Rabbet</i></p>	
<p>ACX.03.69</p> <p>Descrizione <i>Description</i> Doppia maniglia <i>Double Handle “ITALIA”</i></p>		<p>ARX.04.31</p> <p>Descrizione <i>Description</i> Tappo diritto battuta inferiore porte <i>Straight Cap Bottom Rabbet</i></p>	
<p>ACX.03.70</p> <p>Descrizione <i>Description</i> Catenaccio a comando diretto <i>Direct drive bolt</i></p> <p>Sirio</p>		<p>ARX.05.01</p> <p>Descrizione <i>Description</i> Cappetta drenaggio acqua <i>Water Drainage Cap</i></p>	
<p>ACX.03.72</p> <p>Descrizione <i>Description</i> Movimentazione Bidirezionale <i>Bidirectional Movement</i></p> <p>Interasse/Center Dist.=23/35 mm.</p>		<p>ARX.04.60</p> <p>Descrizione <i>Description</i> Kit Tappi di Ripporto Doppia Battuta per XX70.643 <i>Pair double sash door plugs for XX70.643</i></p>	



ARX.06.01		
Descrizione	Description	
Registro Universale Universal Adjusting Spacer Screw		

ARX.06.02		
Descrizione	Description	
Piastrina Registro Universale Universal Plate Adjusting Screw		

ARX.06.03		
Descrizione	Description	
Grano per registro Adjusting Grub Screw		

ACX.06.04		
Descrizione	Description	
Registro Z/P Z/P Adjusting screw		

ARX.06.08		
L=15 mm.		
ARX.06.09		
L=20 mm.		
ARX.06.10		
L=30 mm.		
ARX.06.11		
L=45 mm.		

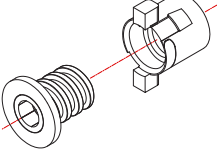
ARX.06.13		
Descrizione	Description	
Registro TWIN Autobloccante su Barrette di Poliammide TWIN Adjusting screw Self-locking on Polyamide Bars		

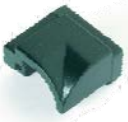
ACX.07.02		
Descrizione	Description	
Angolo Universale Fermavetro Universal Corner Glazing Bead		

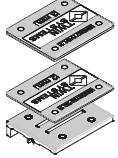
ARX.07.09		
Descrizione	Description	
Supporto vetro Universale Glass support kit Thicknesses 2mm / 3mm		

ACX.08.01		
Descrizione	Description	
ANTA RIBALTA WEEN TILT&TURN SASH		
c/anti falsa manovra sulla Cremonese w/ wrong counter-actuation on the Cremonese bolt		
Portata/Capacity 160 Kg.		KIT BASE BASE KIT

ARX.08.01L		
Descrizione	Description	
ANTA RIBALTA WEEN Logica TILT&TURN SASH		
c/anti falsa manovra sulla Cremonese w/ wrong counter-actuation on the Cremonese bolt		
Portata/Capacity 160 Kg.		KIT BASE BASE KIT

ACX.08.05		
Descrizione	Description	
A.R. Braccio Supplementare A.R. Supplementary Arm		

ACX.08.05L		
Descrizione	Description	
A.R. Braccio Supplementare Logica A.R. Supplementary Arm		

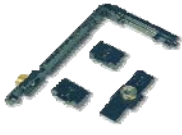
ACX.08.06		
Descrizione	Description	
Chiusura Supplementare Verticale e Universale Supplementary Universal Vertical Closure		

ACX.08.09		
Descrizione	Description	
A.R. Cerniere a Pettine 2.0 A.R. Comb Hinge 2.0		

ACX.08.13		
Descrizione	Description	
Incontro asta singolo Single bar Rest Plate		















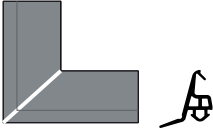



<p>ACX.08.16</p> <p>Descrizione <i>Description</i> Perno chiusura supplementare <i>Pin additional lock</i></p>		<p>ACX.08.25</p> <p>Descrizione <i>Description</i> Kit cerniera a pettine regolabile <i>Hinge kit with adjustable comb</i> Portata/Max Load 120 Kg.</p>	
<p>ACX.08.18</p> <p>Descrizione <i>Description</i> Chiusura supplementare inferiore orizzontale <i>Horizontal bottom additional closure</i></p>		<p>ACX.08.26</p> <p>Descrizione <i>Description</i> Cerniere vasistas a scomparsa <i>Vasistas concealed hinges</i></p>	
<p>ACX.08.19</p> <p>Descrizione <i>Description</i> Microventilazione regolabile <i>Adjustable micro-ventilation</i></p>		<p>ACX.08.27</p> <p>Descrizione <i>Description</i> Corto DX <i>SHORT Right</i></p>	<p>Ween hide 180 Braccio AR a scomparsa <i>Retractable short arm AR</i></p>
<p>ACX.08.22</p> <p>Descrizione <i>Description</i> Anta Ribalta Braccio Corto <i>Drop down door short arm</i> L=395 mm. → 450 mm.</p>		<p>ACX.08.28</p> <p>Descrizione <i>Description</i> Corto SX <i>SHORT Left</i></p>	
<p>ACX.08.22L</p> <p>Descrizione <i>Description</i> Anta Ribalta Braccio Corto <i>Drop down door short arm</i> L=395 mm. → 450 mm.</p>		<p>ACX.08.29</p> <p>Descrizione <i>Description</i> Corto DX <i>SHORT Right</i></p>	
<p>ACX.08.23</p> <p>Descrizione <i>Description</i> Anta Ribalta Braccio Medio <i>Drop down door medium arm</i> L=451 mm. → 650 mm.</p>		<p>ACX.08.30</p> <p>Descrizione <i>Description</i> Corto SX <i>SHORT Left</i></p>	
<p>ACX.08.23L</p> <p>Descrizione <i>Description</i> Anta Ribalta Braccio Medio <i>Drop down door medium arm</i> L=451 mm. → 650 mm.</p>		<p>ACX.08.31</p> <p>Descrizione <i>Description</i> Medio DX <i>Medium Right</i></p>	
<p>ACX.08.24</p> <p>Descrizione <i>Description</i> Anta Ribalta Braccio Lungo <i>Drop down door long arm</i> L=650 mm. → 1700 mm.</p>		<p>ACX.08.32</p> <p>Descrizione <i>Description</i> Medio SX <i>Medium Left</i></p>	
<p>ACX.08.24L</p> <p>Descrizione <i>Description</i> Anta Ribalta Braccio Lungo <i>Drop down door long arm</i> L=650 mm. → 1700 mm.</p>		<p>ACX.08.33</p> <p>Descrizione <i>Description</i> Medio DX <i>Medium Right</i></p>	
		<p>ACX.08.34</p> <p>Descrizione <i>Description</i> Medio SX <i>Medium Left</i></p>	

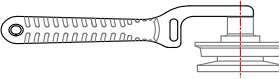

<p>ACX.08.35</p> <p>Descrizione <i>Description</i> Supporto Anta <i>Door Support</i></p> <p>Max load 170 Kg.</p>	<p>Ween hide 180</p> 	<p>ACX.08.44</p> <p>Descrizione <i>Description</i> Catenaccio a leva ad appoggio <i>Lever Bolt</i></p>	<p>Per anta affiancata WEEN <i>For WEEN</i> Side-by-Side-Door</p> 
<p>ACX.08.36</p> <p>Descrizione <i>Description</i></p> <p>DX Right</p>	<p>Ween hide 180</p> 	<p>ARX.09.01</p> <p>Descrizione <i>Description</i> Attrezzatura Pneumatica <i>Pneumatic Equipment</i></p>	
<p>ACX.08.37</p> <p>Descrizione <i>Description</i></p> <p>SX Left</p>		<p>ACX.20.01</p> <p>Descrizione <i>Description</i> Attuatore a catena radiocomandato <i>Remote-Controlled Chain Actuator</i></p>	<p>WI-CLOUD RC</p> 
<p>ACX.08.38</p> <p>Descrizione <i>Description</i></p> <p>DX Right</p>	<p>Ween hide 180 Cerniera Sup. Scomparsa <i>Top Retractable Hinge</i></p> 	<p>ARX.20.02</p> <p>Descrizione <i>Description</i> Radiocomando <i>Remote-Control</i></p>	<p>WI-CONTROL</p> 
<p>ACX.08.39</p> <p>Descrizione <i>Description</i></p> <p>SX Left</p>		<p>ACX.20.03</p> <p>Descrizione <i>Description</i> Attuatore a catena radiocomandato <i>Remote-Controlled Chain Actuator</i></p>	<p>WI-CLOUD</p> 
<p>ACX.08.40</p> <p>Descrizione <i>Description</i> Rinvio d'angolo, terminali e riscontri in zama <i>Corner return, terminals and handles in zamak.</i></p>	<p>Ween hide 180 KIT BASE c/Anti Falsa Manovra su CREMONESE <i>BASE KIT w/wrong counter-actuation on CREMONESE Bolt</i></p> 	<p>ARX.20.04</p> <p>Descrizione <i>Description</i> Attuatore a catena c/serratura elettromeccanica <i>Chain Actuator w/Electromechanical Lock</i></p>	<p>WI-CLOUD RC-LOCK</p> 
<p>ACX.08.41</p> <p>Descrizione <i>Description</i></p> <p>Logica</p>		<p>Descrizione <i>Description</i></p>	<p>Descrizione <i>Description</i></p>
<p>ACX.08.42</p> <p>Descrizione <i>Description</i> c/scatto microventilazione w/Microventilation Trigger</p> <p>Sporg. Quadro <i>Rosette Projection</i> 24 mm.</p>	<p>Martellina ITALIA</p> 	<p>Descrizione <i>Description</i></p>	<p>Descrizione <i>Description</i></p>
<p>ACX.08.43</p> <p>Descrizione <i>Description</i> Anta Ribalta Automatica <i>Automatic Tilt&Turn Sash</i></p> <p>Max load 160 Kg.</p>	<p>Ween Wi-Cloud ar</p> 	<p>Descrizione <i>Description</i></p>	<p>Descrizione <i>Description</i></p>



GUARNIZIONI | GASKETS

<p>ARX.10.01</p> <p>Descrizione <i>Description</i> Guarnizione centrale di Precamera <i>Pre-chamber Central window gasket</i></p>		<p>ARX.10.12</p> <p>Descrizione <i>Description</i> Spessore Width = 3 - 4 mm.</p>	<p>Guarnizione Vetro INT <i>Glass Window Gasket INT</i></p> 
<p>ARX.10.02</p> <p>Descrizione <i>Description</i> Angolo per Guarnizione centrale di Precamera <i>Corner for Pre-chamber Central window gasket</i></p>		<p>ARX.10.13</p> <p>Spessore Width = 5 - 6 mm.</p>	
<p>ACX.10.03</p> <p>Descrizione <i>Description</i> Guarnizione di battuta a scatto <i>Snap-On Rabbet window gasket</i></p>		<p>ARX.10.14</p> <p>Spessore Width = 7 - 8 mm.</p>	
<p>ACX.10.04</p> <p>Descrizione <i>Description</i> Guarnizione di battuta ad infilo <i>Door with glazing (glass) panels window gasket</i></p>		<p>ARX.10.15</p> <p>Spessore Width = 9 - 10 mm.</p>	
<p>ARX.10.05</p> <p>Descrizione <i>Description</i> Guarnizione vetro esterna <i>External glass gasket</i></p>		<p>ARX.10.27</p> <p>Descrizione <i>Description</i> Rotella infila guarnizioni <i>Window gasket threader</i></p>	
<p>ARX.10.05.1</p> <p>Descrizione <i>Description</i> Guarnizione vetro esterna coestrusa per isolamento termico-acustico <i>Coextruded external glass gasket for thermal-acoustic insulation</i></p>		<p>ASX.10.35</p> <p>Descrizione <i>Description</i> Guarnizione rigida per porte <i>Rigid window gasket for doors</i></p>	
<p>ARX.10.06</p> <p>Descrizione <i>Description</i> Guarnizione sotto vetro per isolamento termico-acustico <i>Gasket under glass for thermal-acoustic insulation</i></p>		<p>ACX.10.71</p> <p>Descrizione <i>Description</i> Guarnizioni fermavetro di sicurezza (a pezzi) <i>Item for safety glazing bead (in pieces)</i></p>	
<p>ARX.10.07</p> <p>Descrizione <i>Description</i> Guarnizione di battuta acustica <i>EXT glass acoustic window gasket</i></p>		<p>ASX.10.79</p> <p>Descrizione <i>Description</i> Guarnizione telaio riportata SX700 <i>SX700 frame gasket</i></p>	
<p>ARX.10.08</p> <p>Descrizione <i>Description</i> Guarnizione di battuta <i>Rabbet window gasket</i></p>	<p>FERRAMENTA A NASTRO TAPE HARDWARE</p> 	<p>ACX.10.83</p> <p>Descrizione <i>Description</i> Spazzola lineare filamento di Polipropilene XX70.643 Dim. 15x2.5 <i>Spazzola lineare filamento di Polipropilene XX70.643 Dim 15x2.5</i></p>	

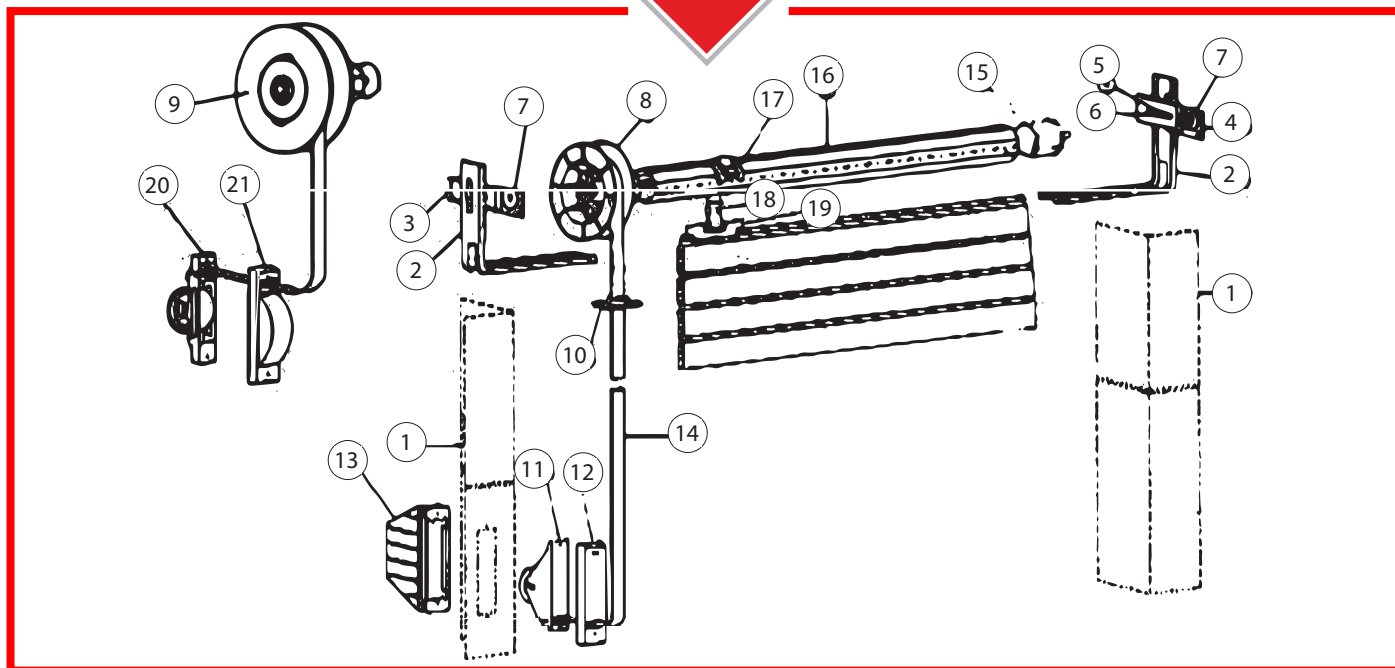

MONOBLOCCO - Soluzione Puleggia | Monobloc - Solution with pulley

Art./Item	Descrizione Description	Dim (mm.)	Rif. Ref.	Scelta Choice	Rif. Ref.
ARX.11.01	Supporto a squadra Square support	A = 46	2		2
ARX.11.02	Mensola per Supporto(SX) Support Shelf (Left)		1		3
ARX.11.03	Mensola per Supporto(DX) Support Shelf (Right)		1		4
ARX.11.04	Vite 6x20 c/dado Screw W/Nut		2		5-6
ARX.11.05	Boccola in Nylon Nylon Bushing		2		7
ARX.11.06	Puleggia in Plastica a Minimo Ingombro Small Sized Plastic Pulley	Ø 220	1	Tipo Type	8
ARX.11.07	Guida Cinghia Trasversale in Nylon Nylon cross strap guide		1	Colore Colour	10
ARX.11.08	Avvolgitore Rewinder		1		11
ARX.11.09	Placca Plaque		1	Tipo Type	12
ARX.11.10	Cassetta Cassette		1	Tipo Type	13
ARX.11.11	Cintolino Tape		Mt.	Tipo Type	14
ARX.11.12	Calotta in Plastica Plastic Cap		1		15
ARX.11.13	Rullo Ottagonale Octagonal Roller		Mt.	Tipo Type	16
ARX.11.14	Gancio Attacco Cintino/Rullo Hook for attaching the tape to the roller		2		17
ARX.11.15	Grappa Fermacintino Tape Locking Clip		2		18
ARX.11.16	Gancio per Avvolgibile in Plastica c/Asola Plastic Roller Hook w/Slot		2		19

MONOBLOCCO - Soluzione Puleggia | Monobloc - Solution with pulley

ARX.11.18	Riduttore portata 40 kg. Square support A= mm 46.	R=1;2.6	1		9
	Puleggia	Ø 220	1		
ARX.11.19	Avvolgitore Rewinder		1		20
ARX.11.20	Placca Plaque		1	Tipo Type	21

Vari | Miscellaneous

ARX.11.21	Invito Tapparella [Nylon su Profilo Alluminio] Shutter Guide [Nylon on Aluminium Profile]				
ARX.11.22	Coppia Tappi Laterali Cassonetto in Alluminio Pair of side caps for aluminium shutter box				



Nodi
Main Sections

Gruppo D

Sezioni principali
e Accessori
Sc. 1:1

*Main Sections and
Accessories
Scale 1:1*



SCHEMA DIMENSIONALE
DIMENSIONAL DIAGRAM

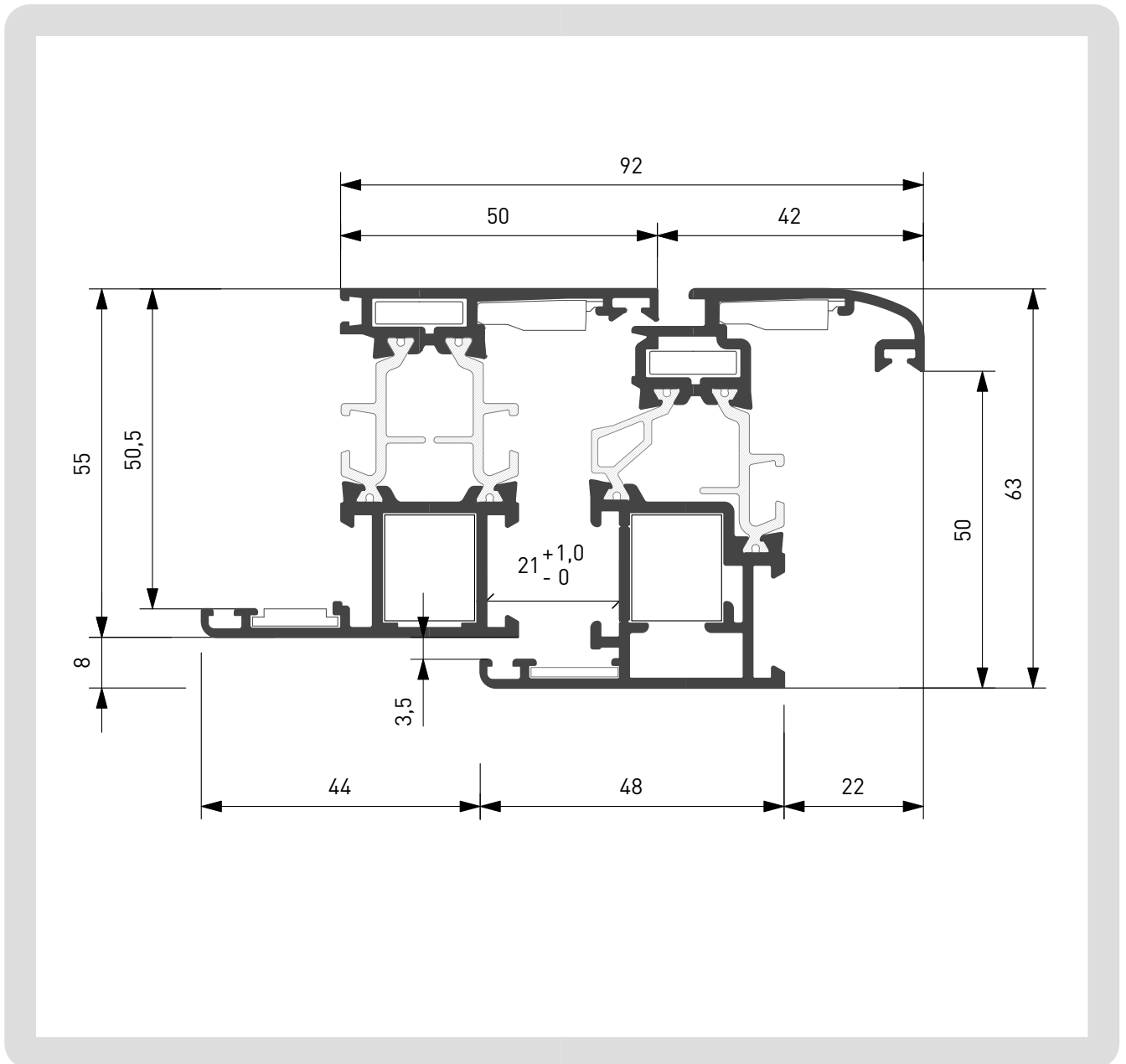



FINESTRA A 2 ANTE
DOUBLE SASH WINDOW

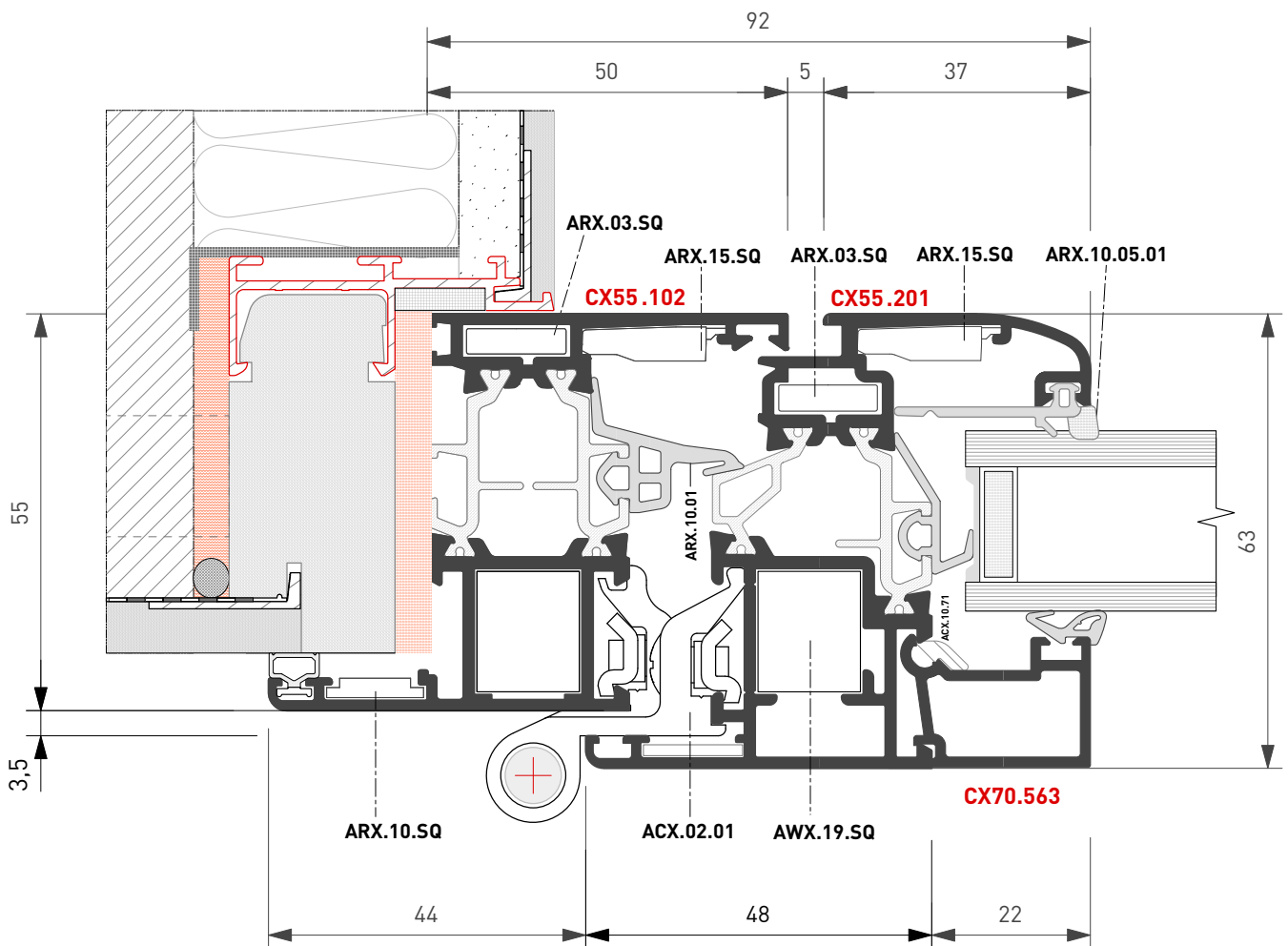
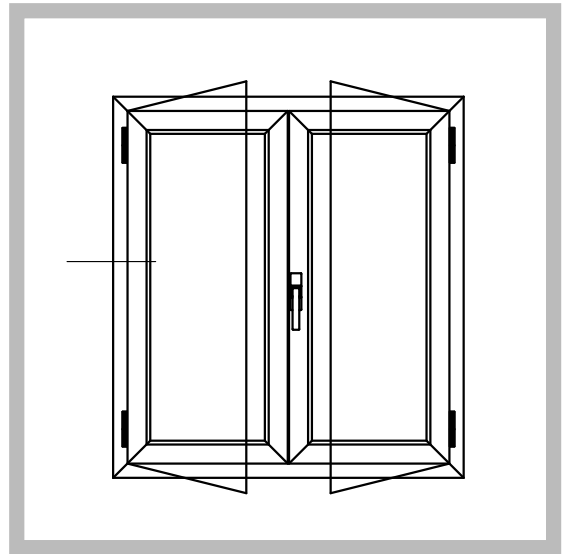



FINESTRA A 2 ANTE
DOUBLE SASH WINDOW

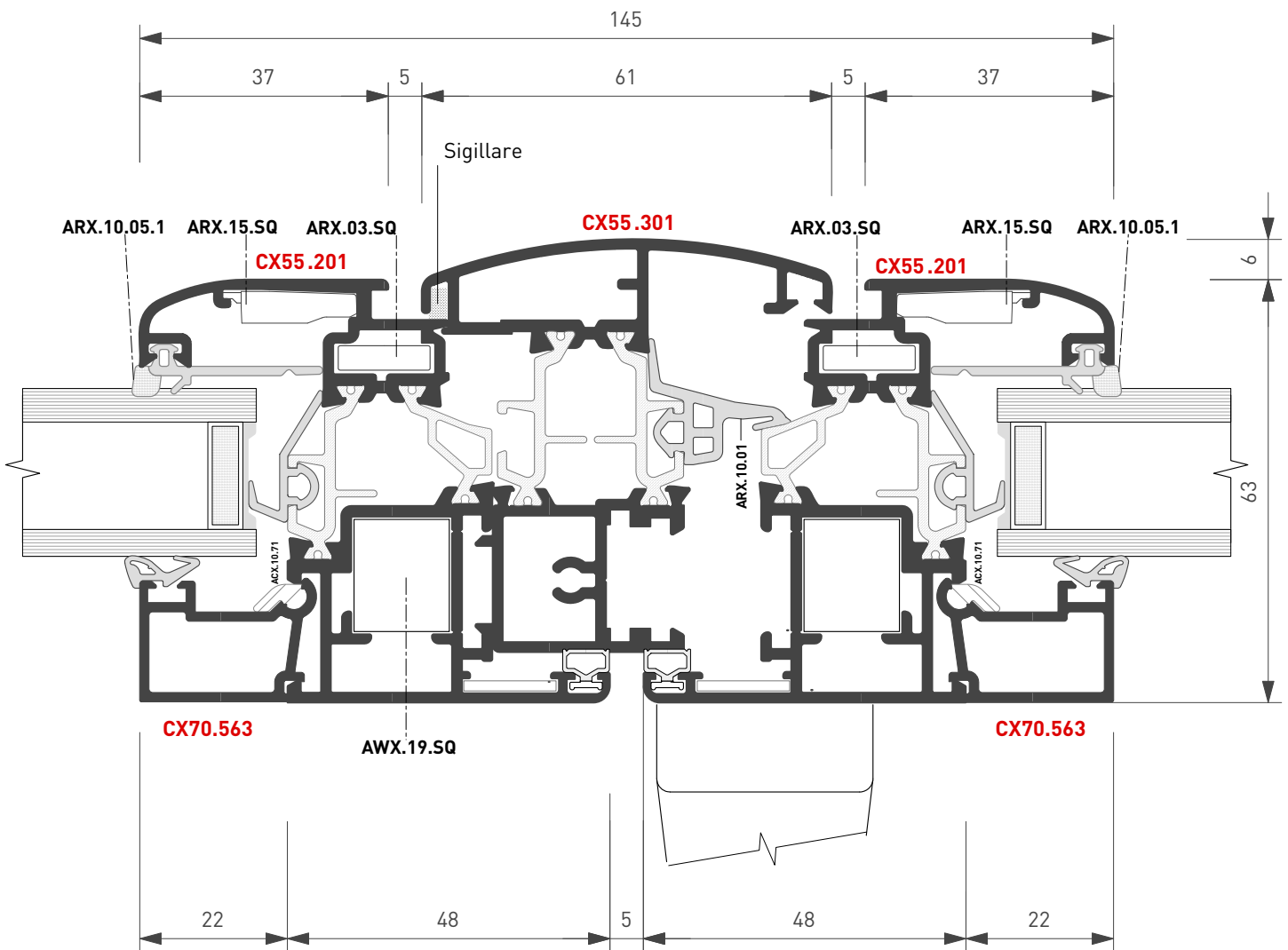
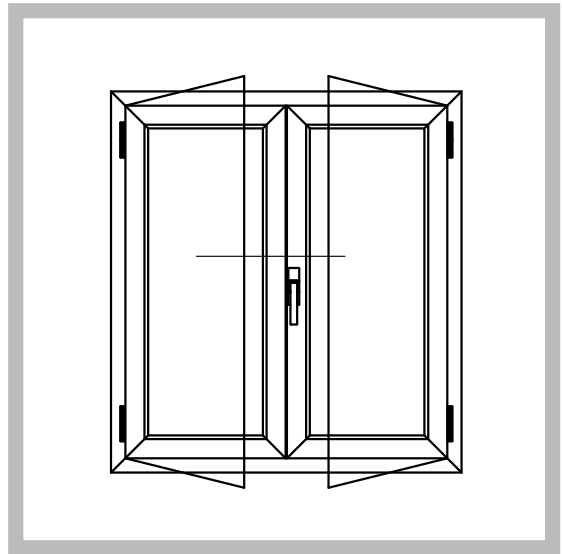



FINESTRA A 2 ANTE
DOUBLE SASH WINDOW

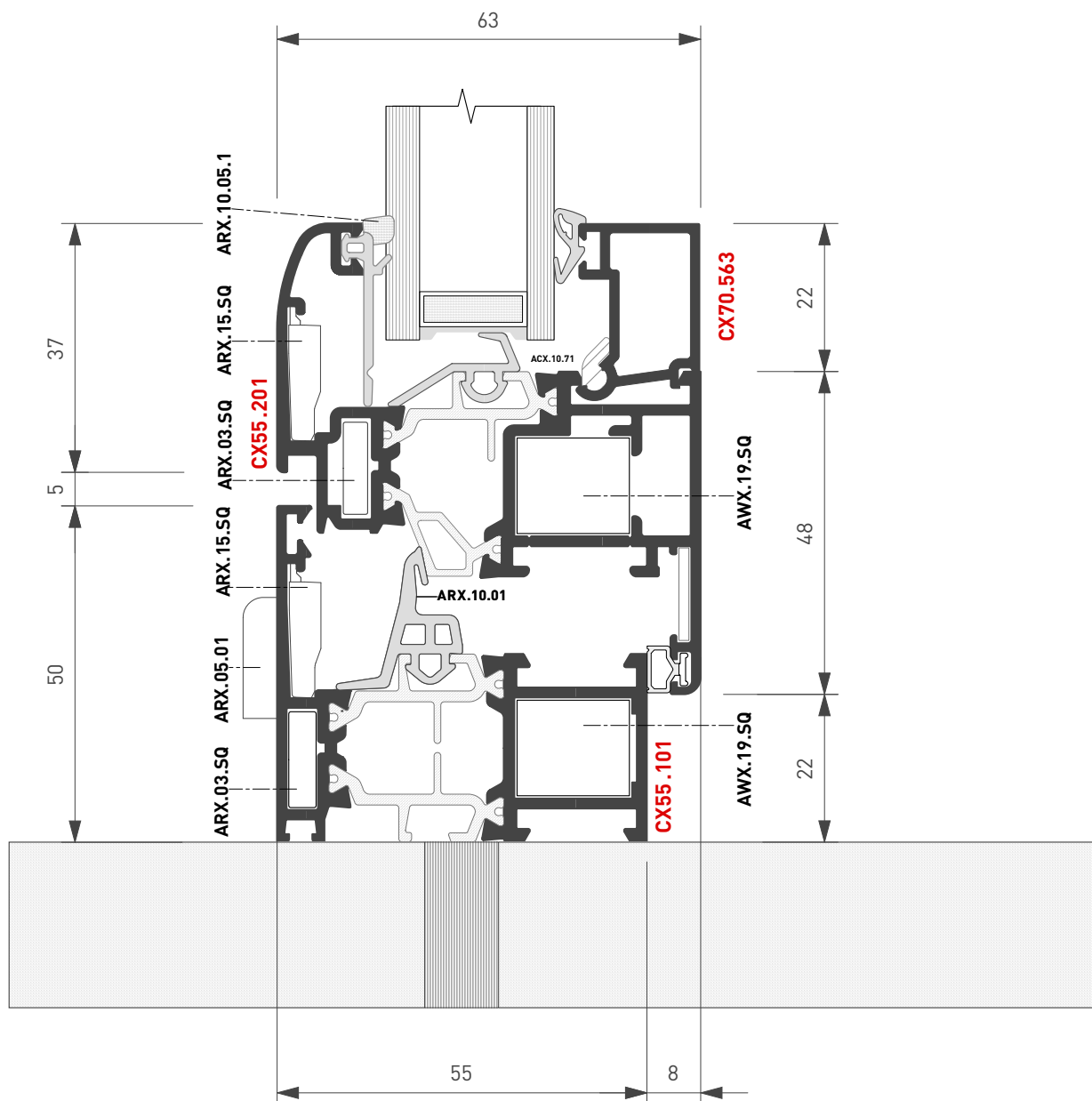
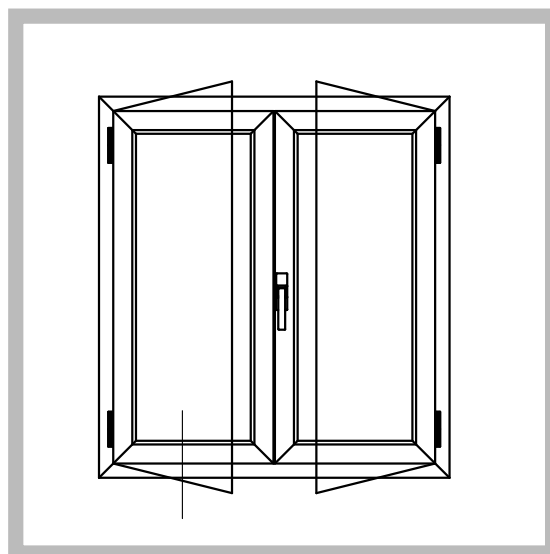



PORTA BALCONE A 2 ANTE
con soglia bassa
DOUBLE SASH BALCONY DOOR
W/LOW TRESHOLD

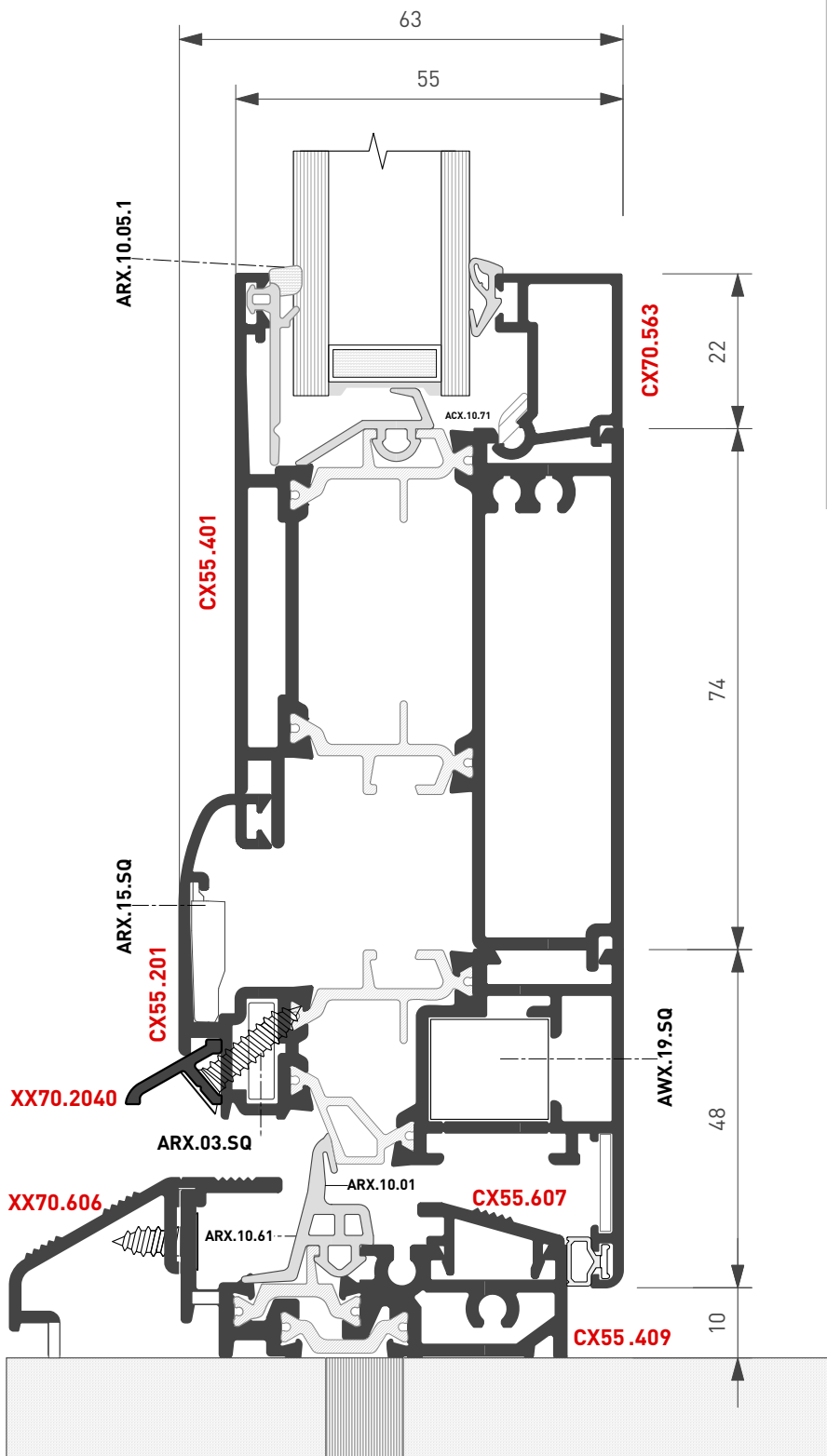
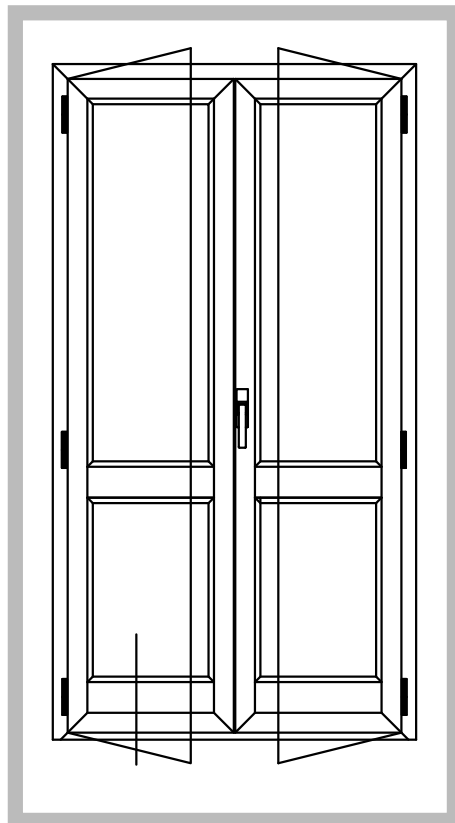



PORTA BALCONE A 2 ANTE
DOUBLE SASH BALCONY DOOR

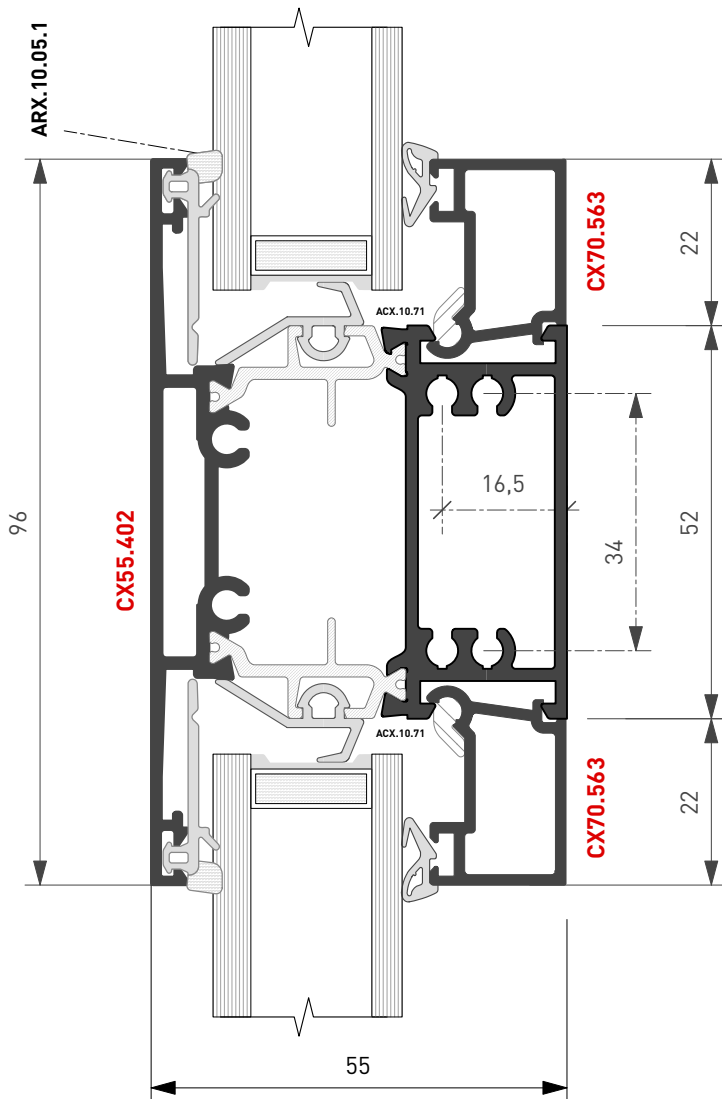
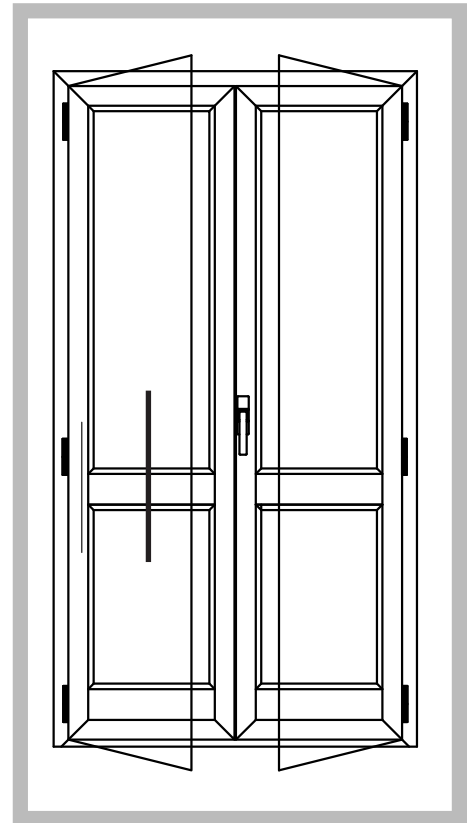



FINESTRA A 2 ANTE
DOUBLE SASH WINDOW

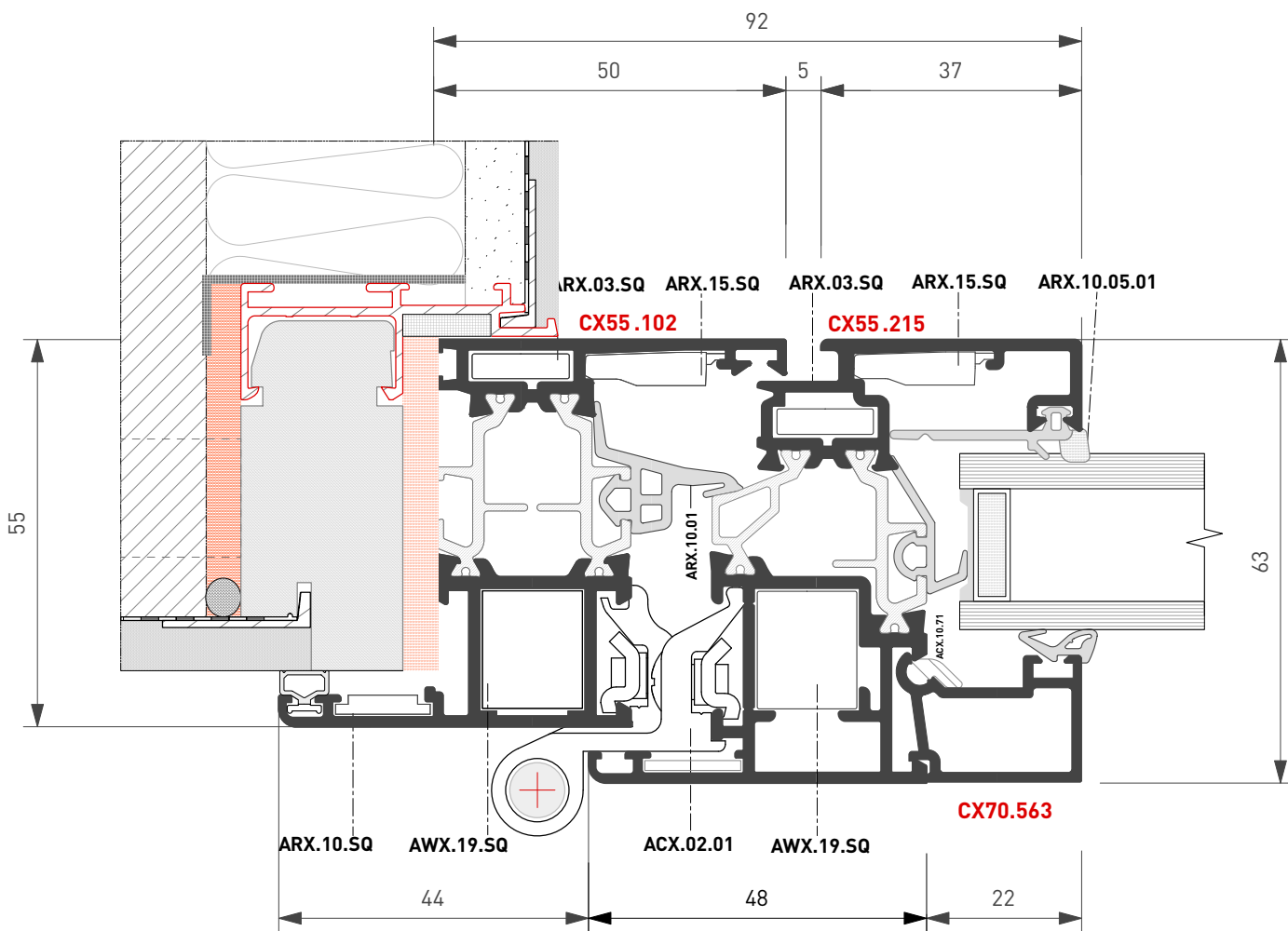
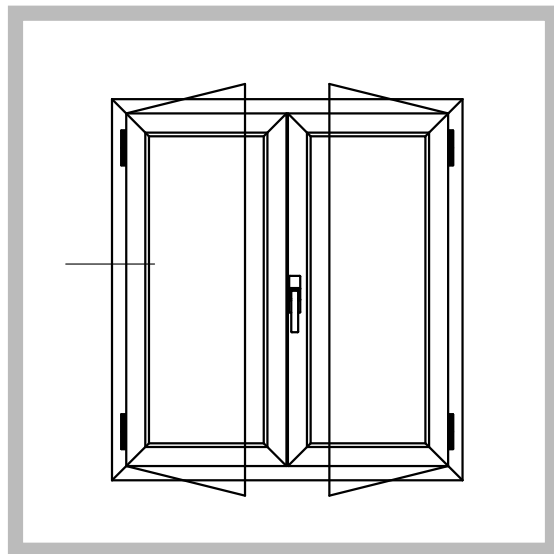



FINESTRA A 2 ANTE
DOUBLE SASH WINDOW

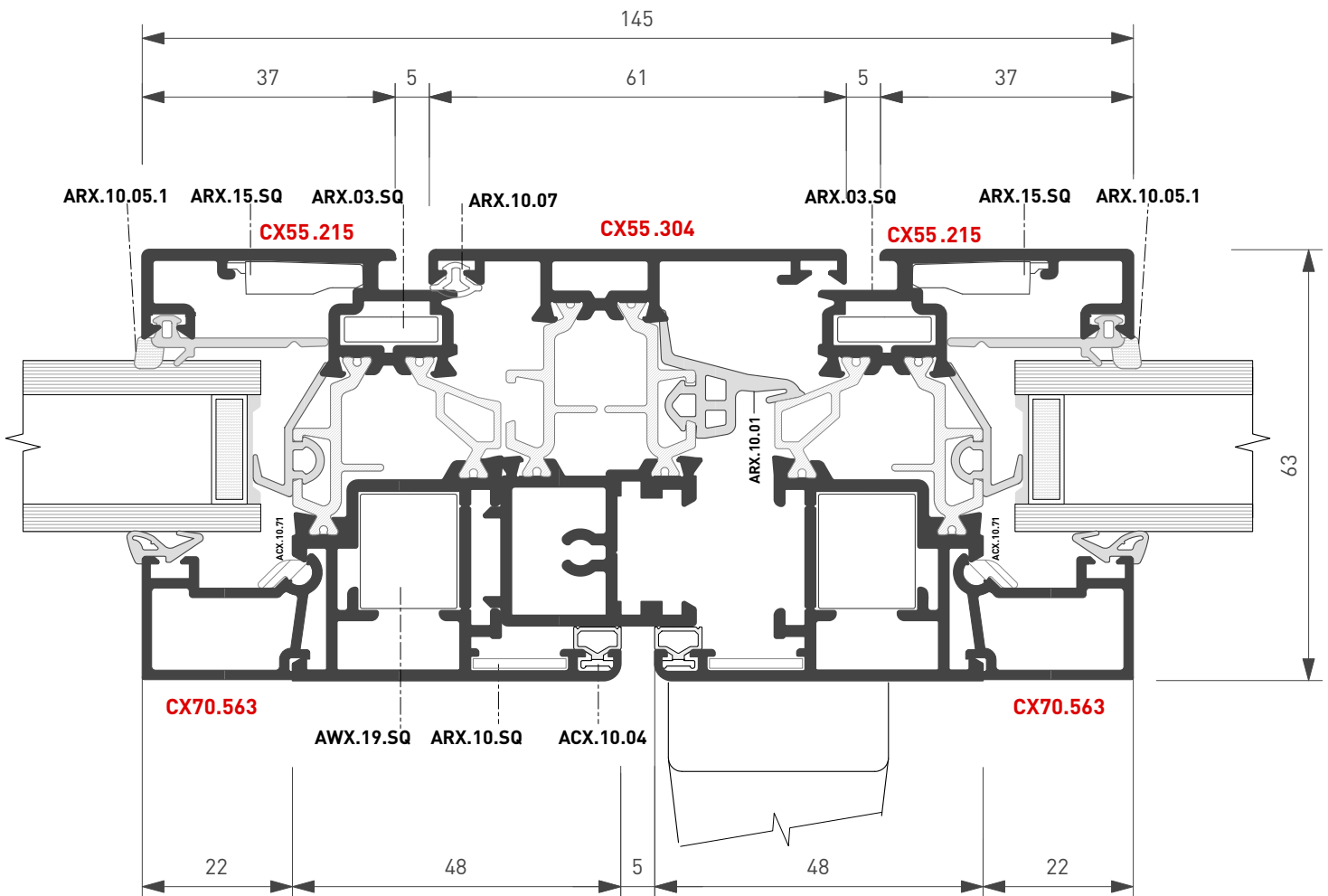
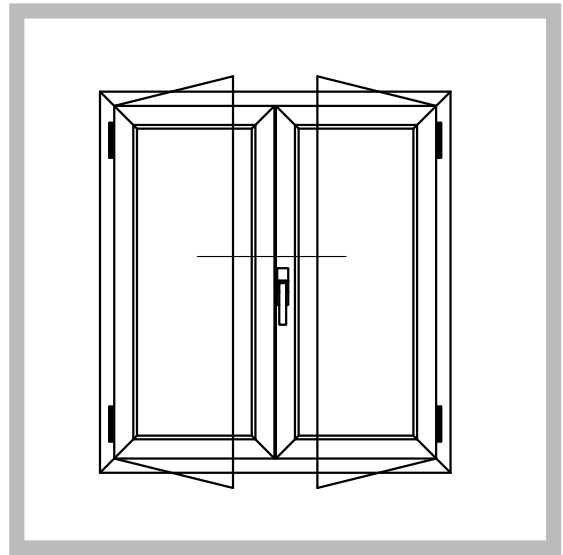



FINESTRA A 2 ANTE
Vetro ad infilare
DOUBLE SASH WINDOW
Insert Glass

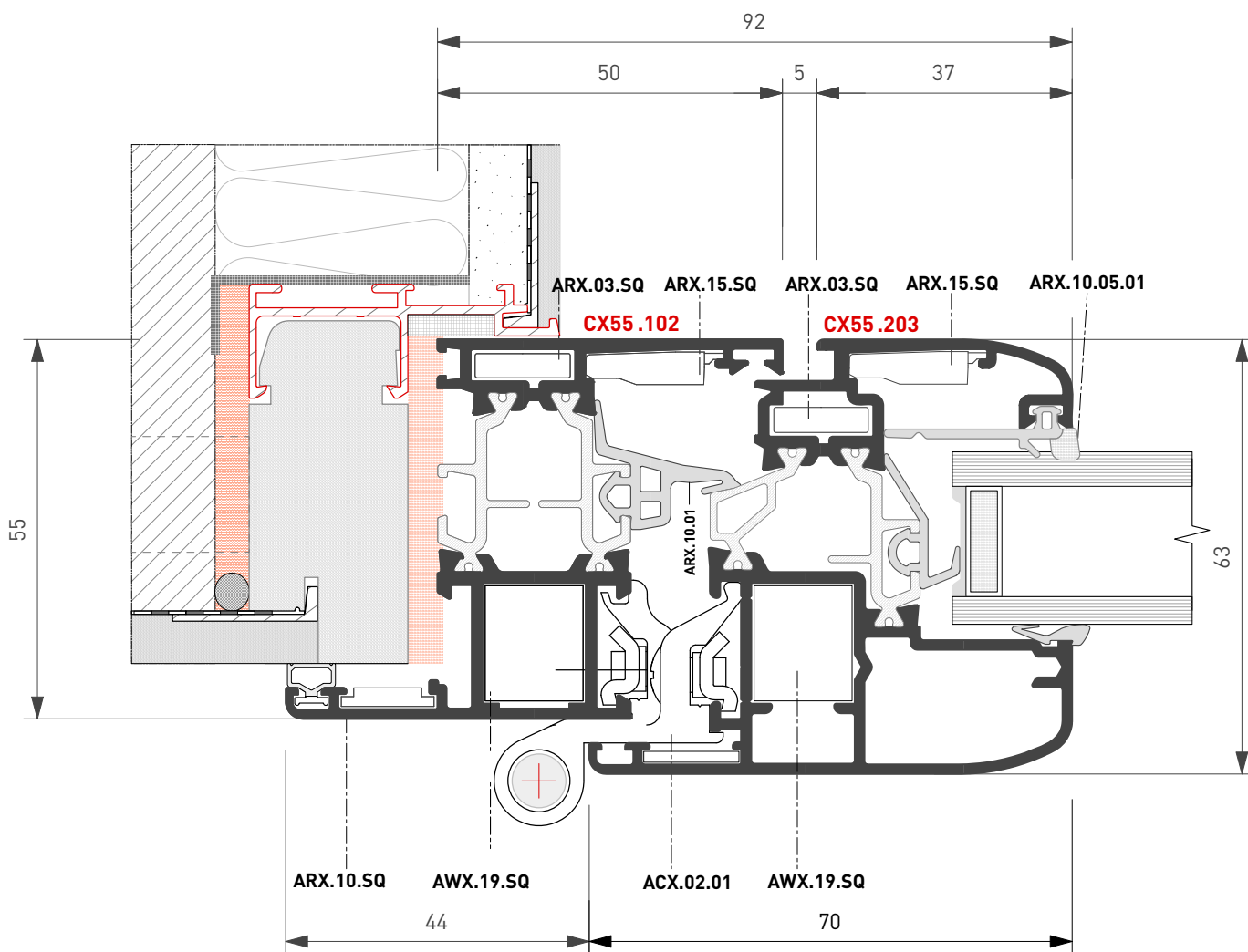
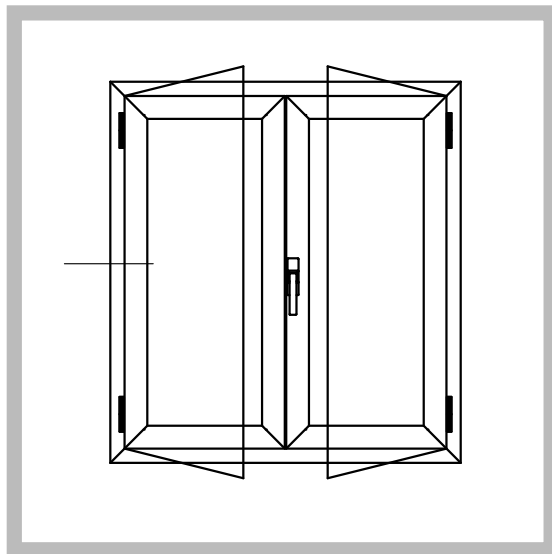



FINESTRA A 2 ANTE
Vetro ad infilare
DOUBLE SASH WINDOW
Insert Glass

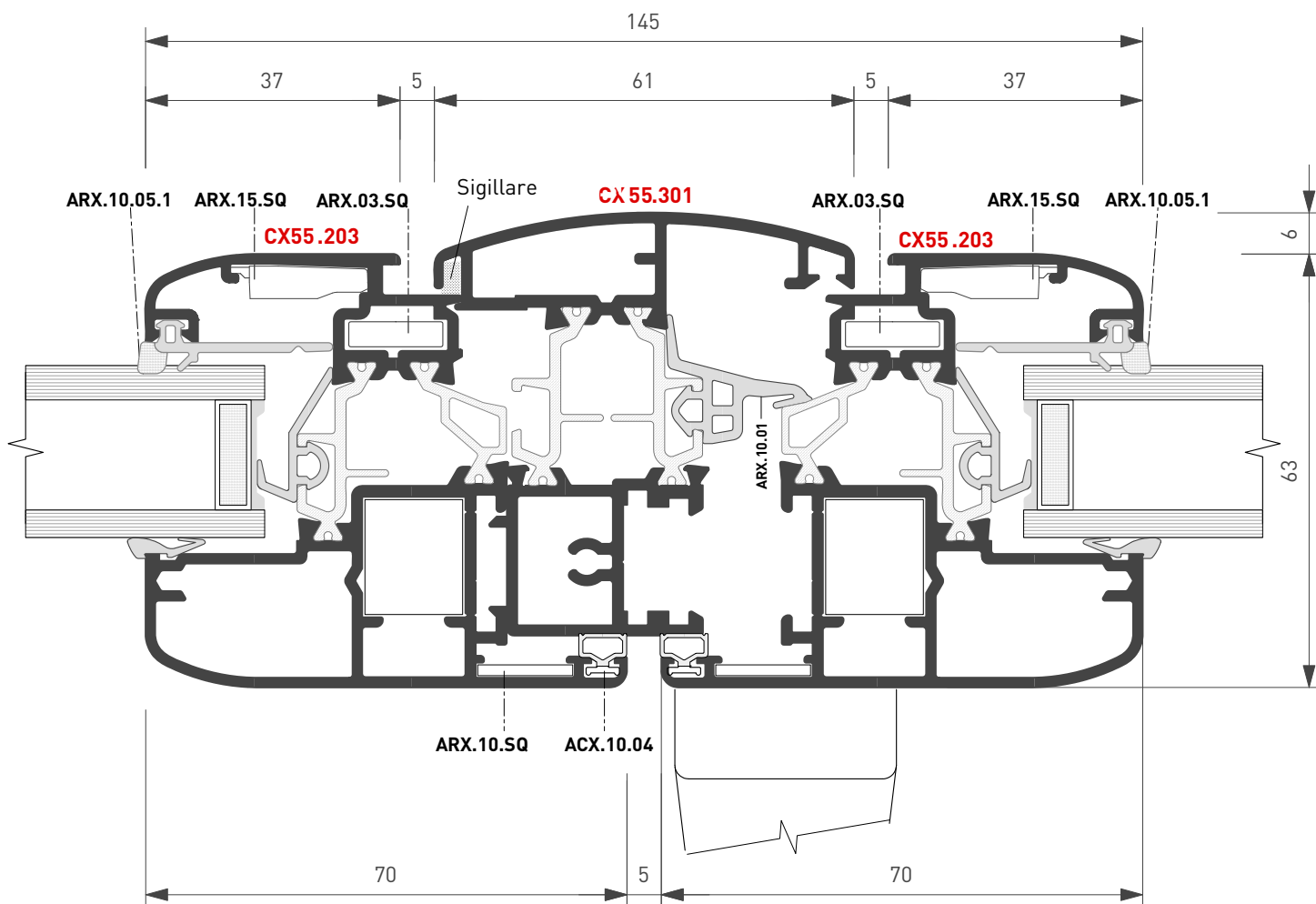
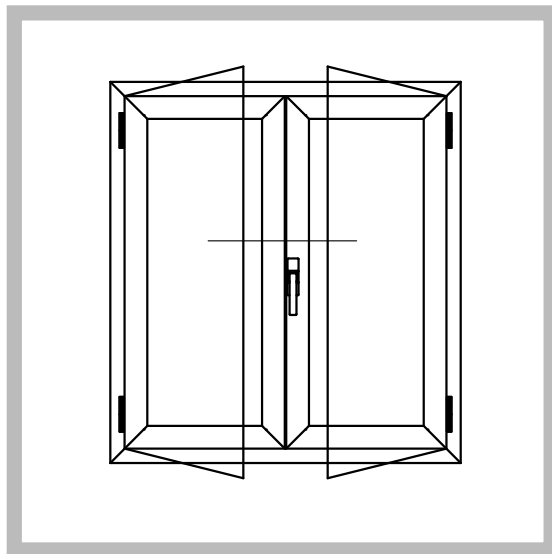



PORTA BALCONE A 2 ANTE
Vetro ad infilare
DOUBLE SASH BALCONY DOOR
Insert Glass

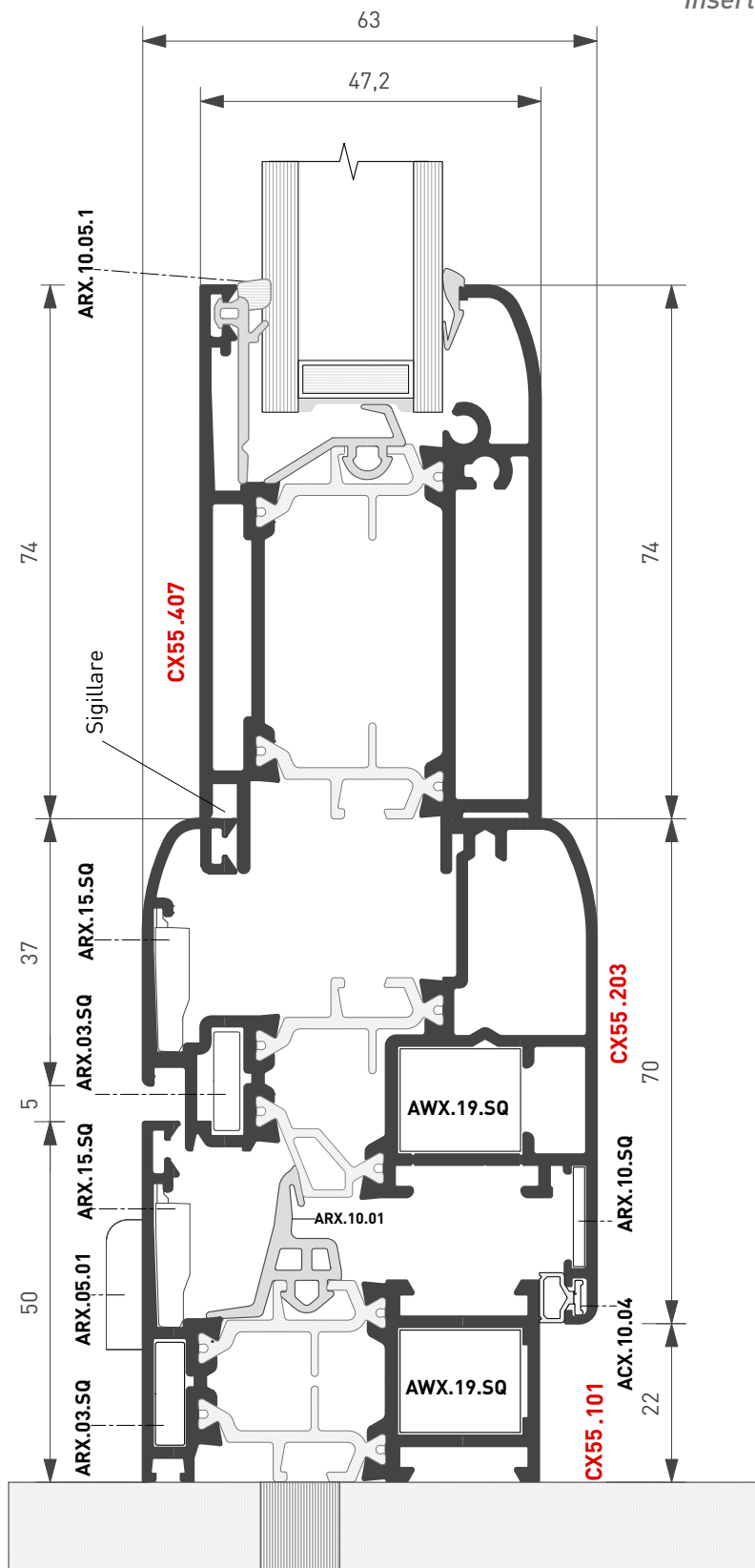
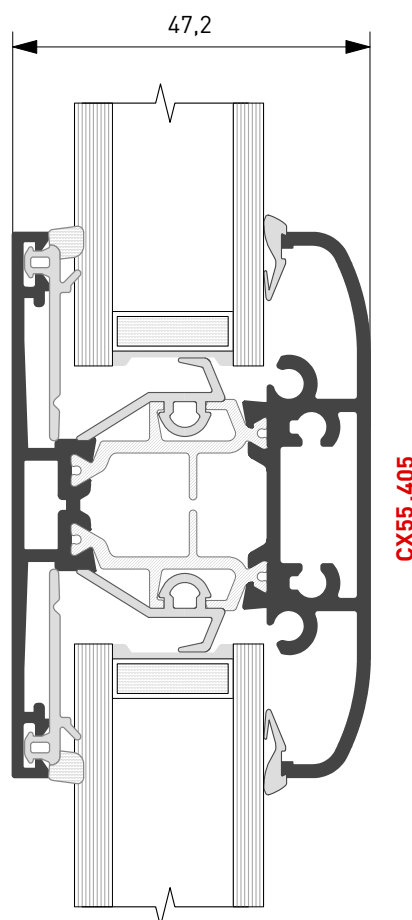
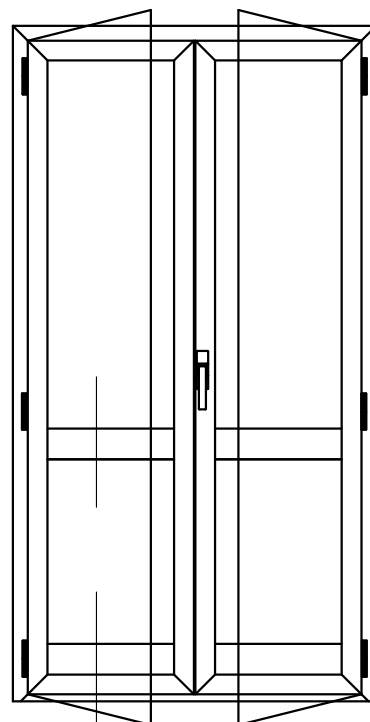



FINESTRA A 2 ANTE
Vetro ad infilare
DOUBLE SASH WINDOW
Insert Glass

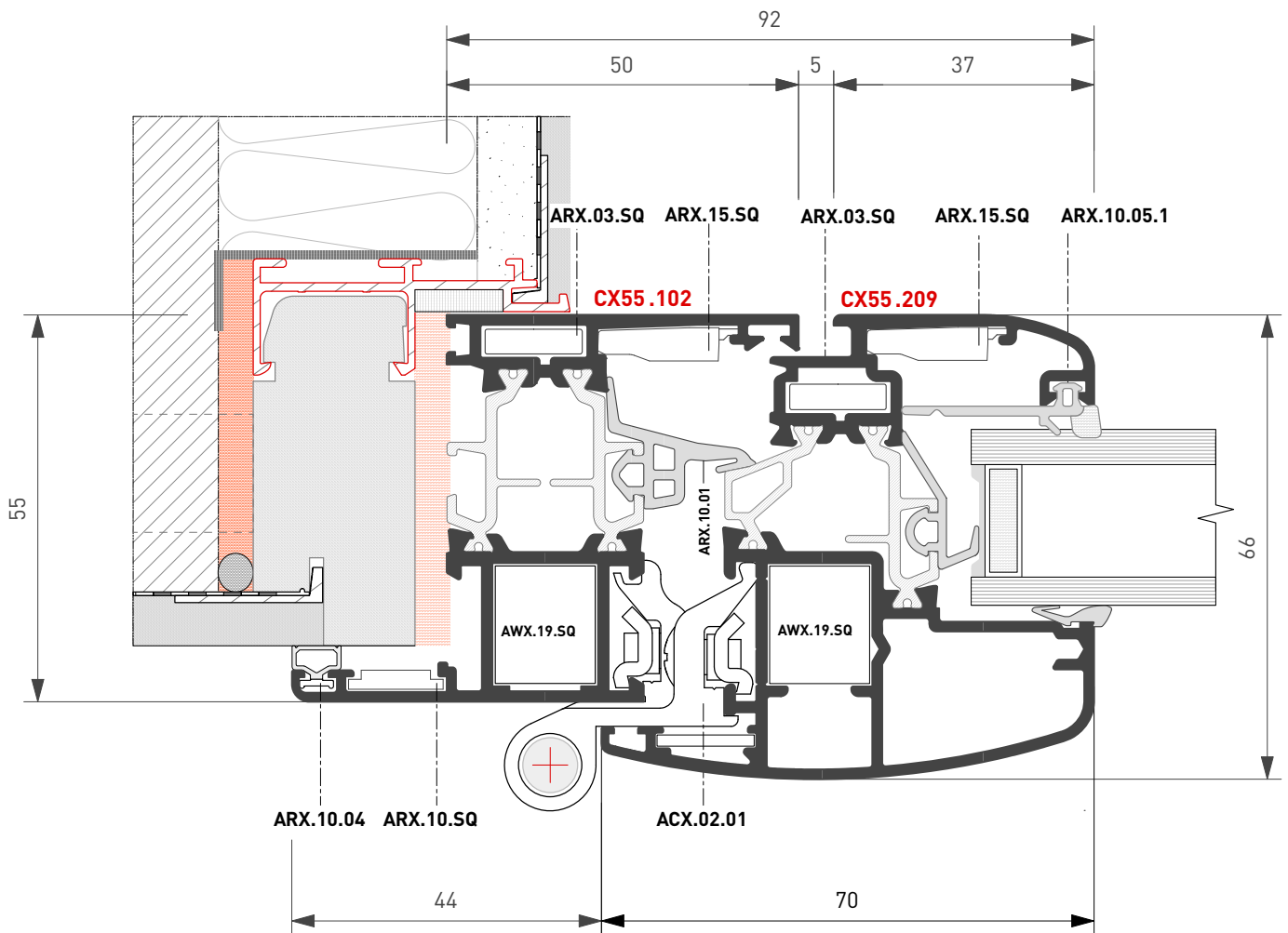
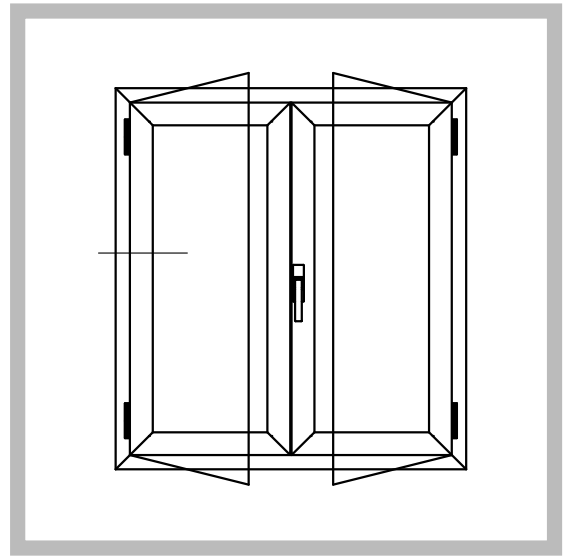



FINESTRA A 2 ANTE
Vetro ad infilare
DOUBLE SASH WINDOW
Insert Glass

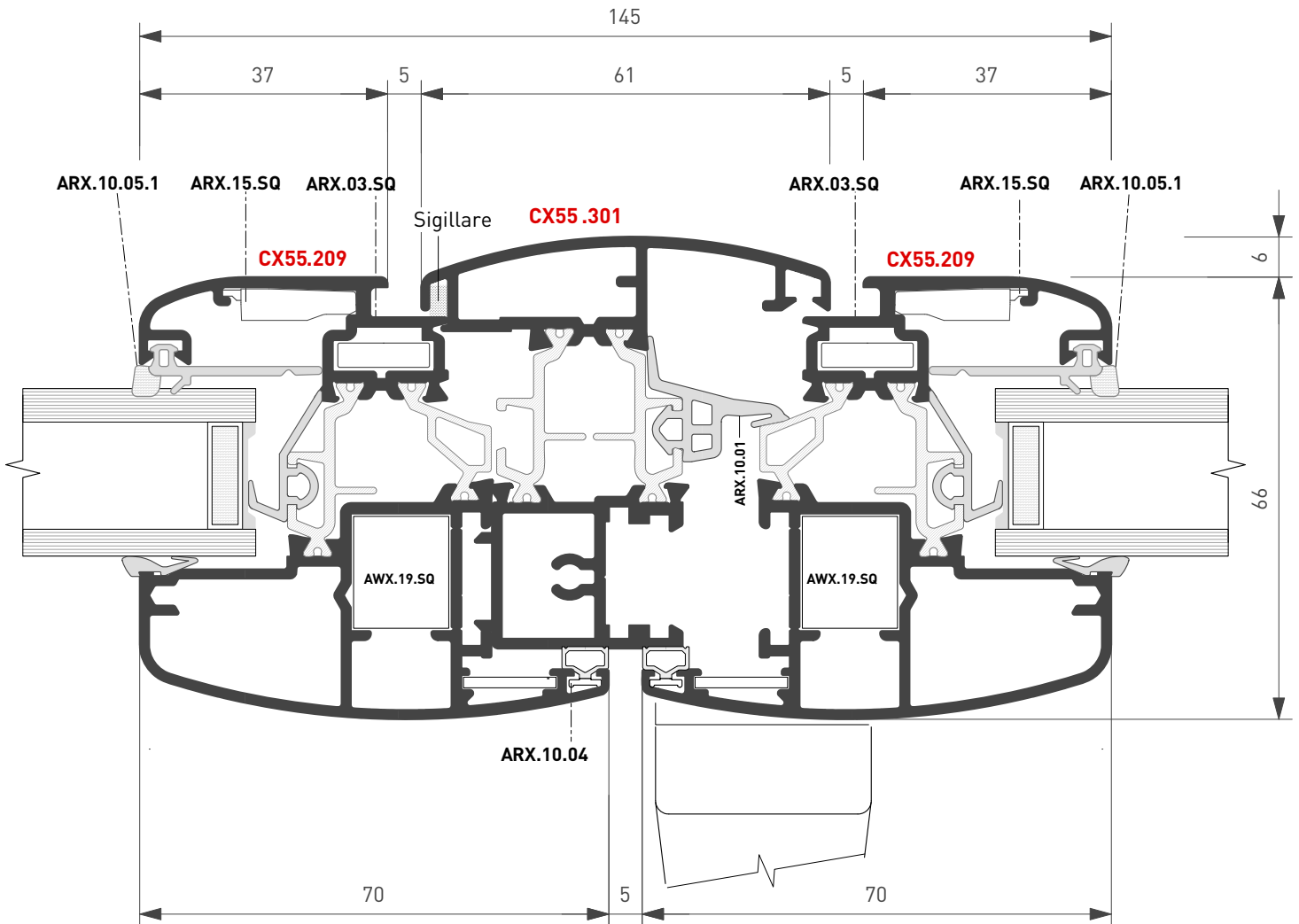
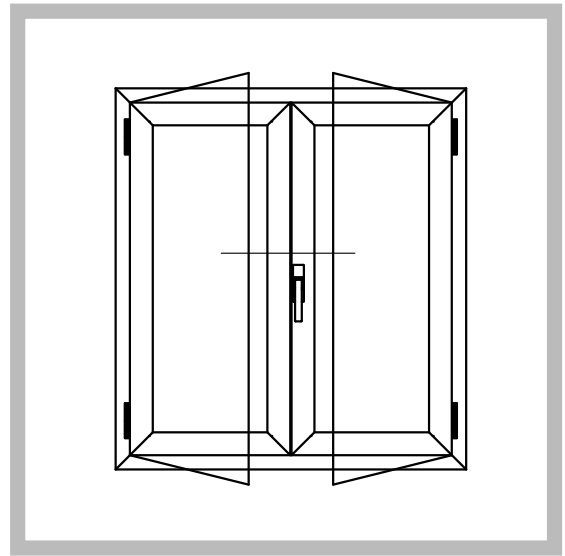



FINESTRA A 2 ANTE
Vetro ad infilare
DOUBLE SASH WINDOW
Insert Glass

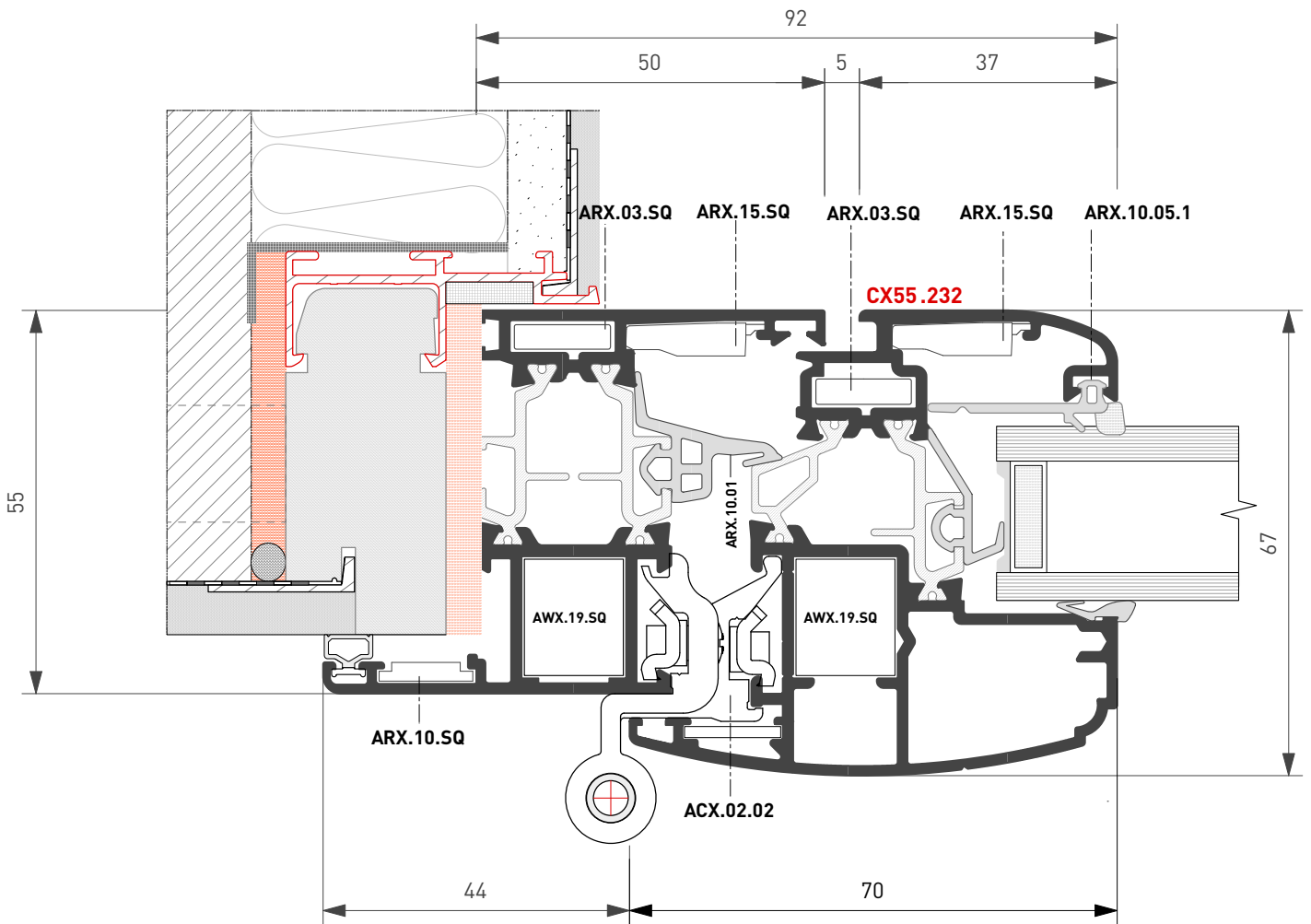
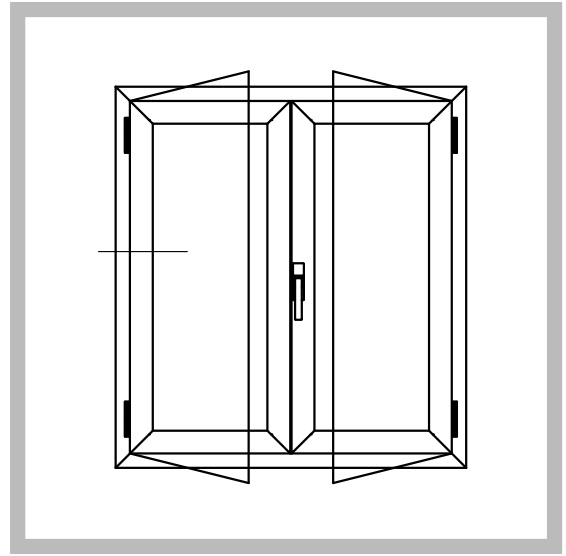



FINESTRA A 2 ANTE
Vetro ad infilare
DOUBLE SASH WINDOW
Insert Glass

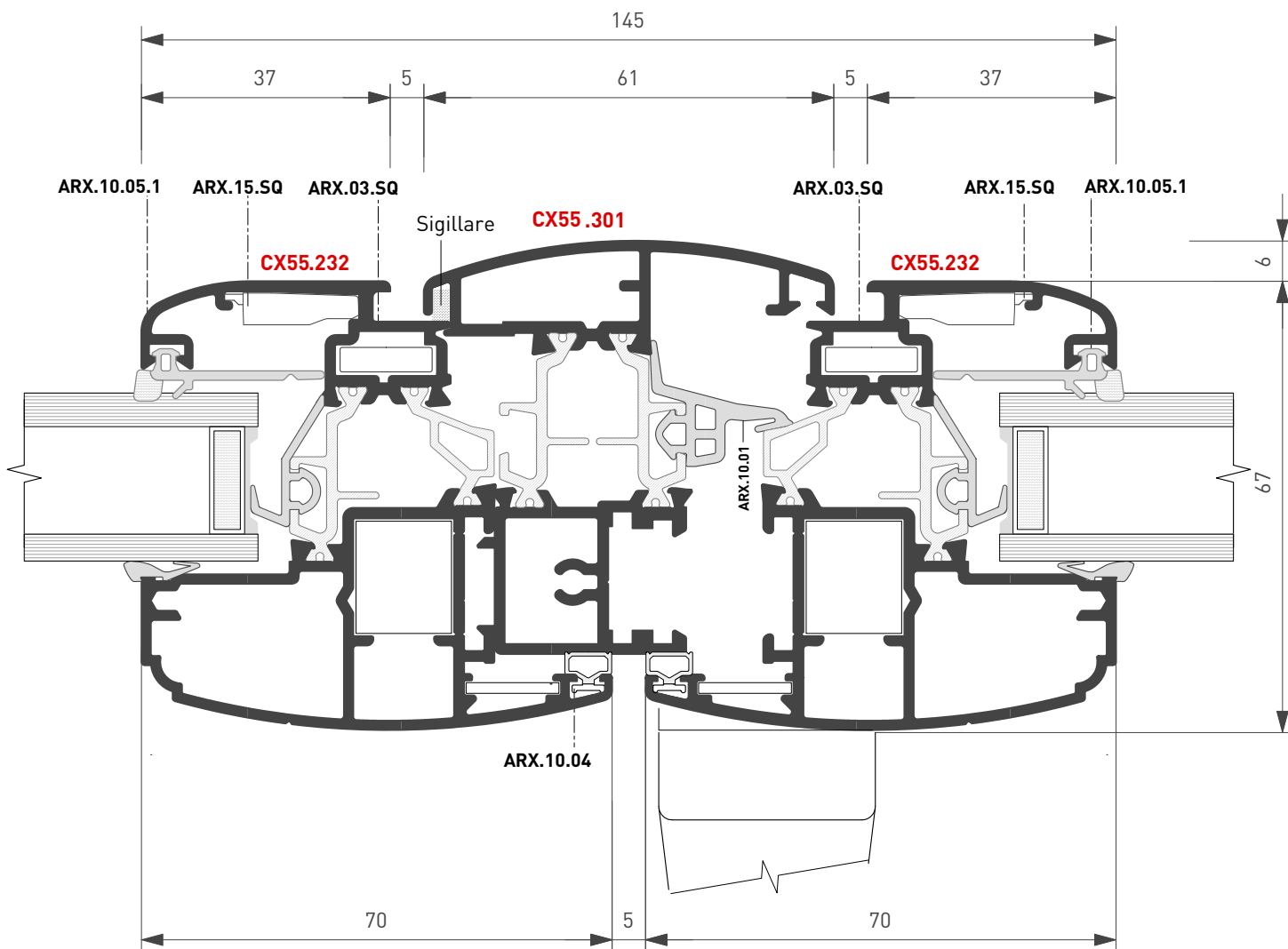
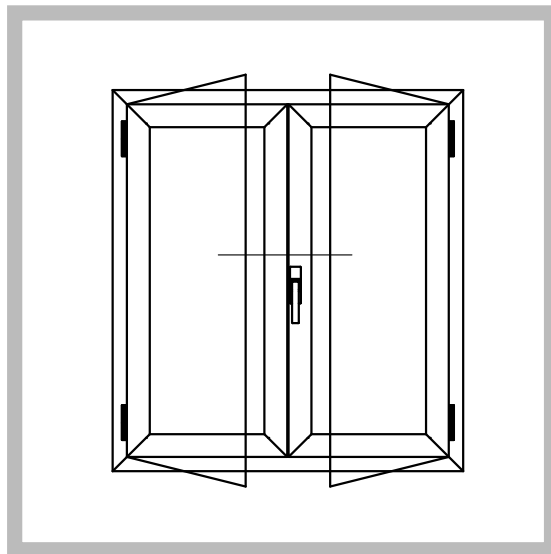



FINESTRA A 2 ANTE
Vetro ad infilare
DOUBLE SASH WINDOW
Insert Glass

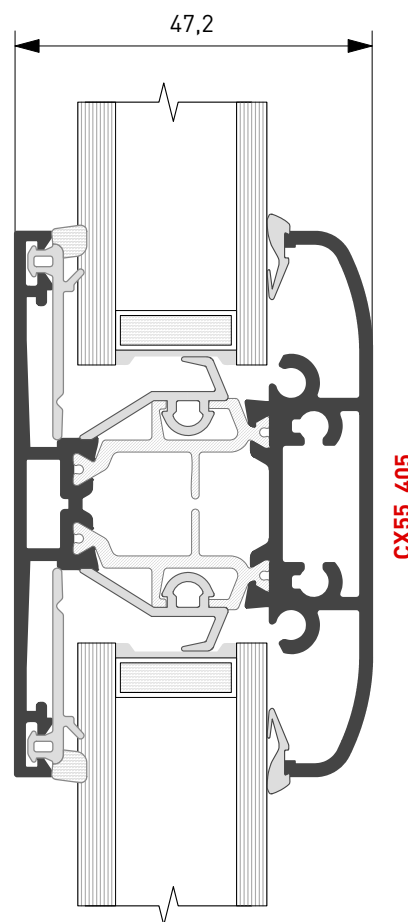
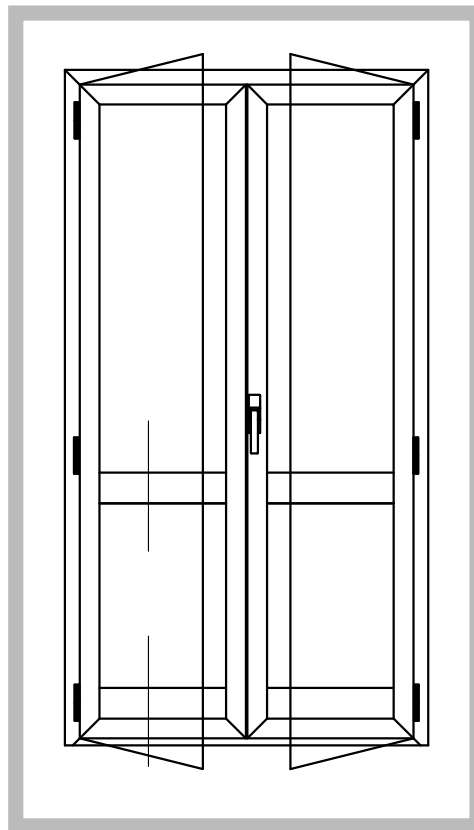
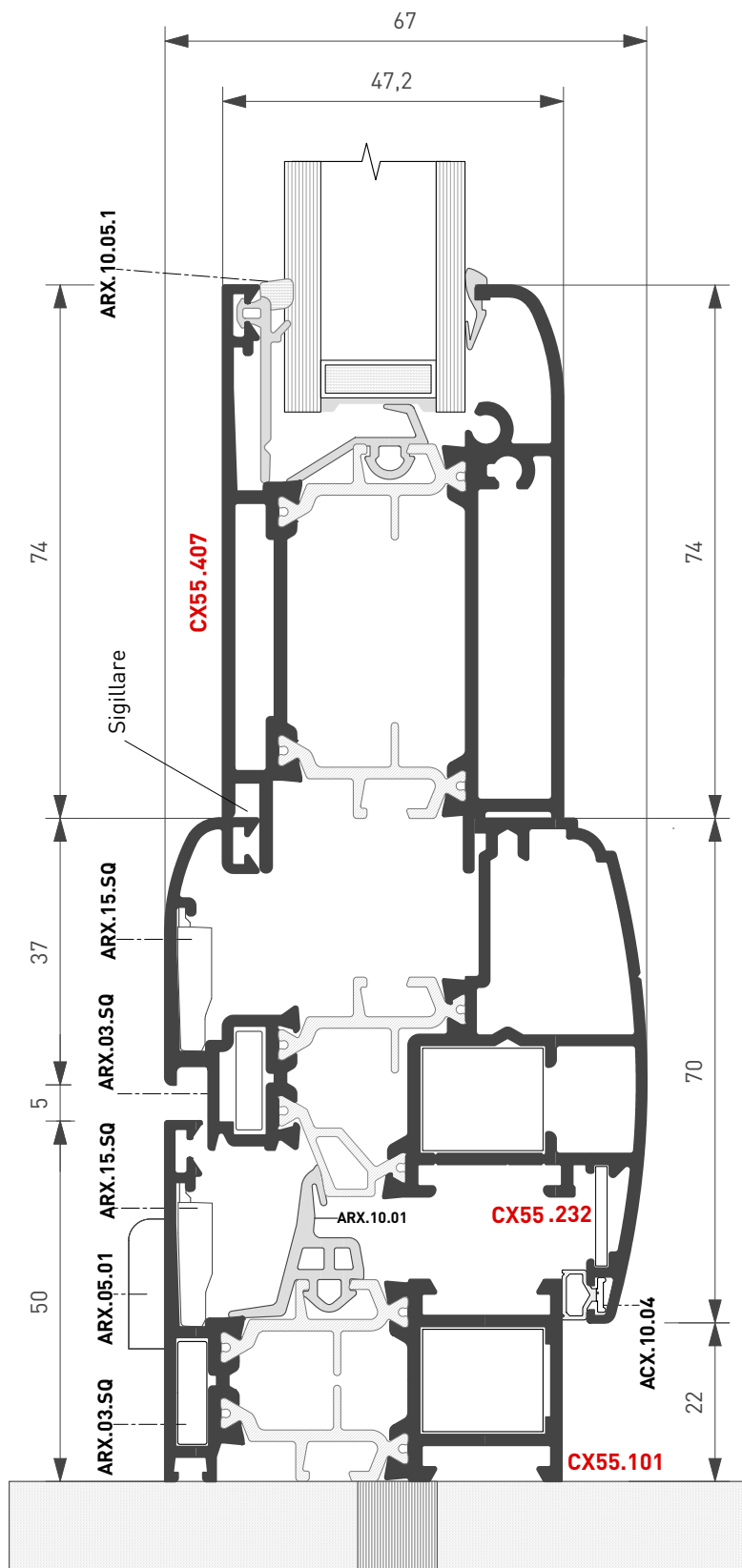



**FINESTRA
BILICO VERTICALE
VERTICAL PIVOT
WINDOW**

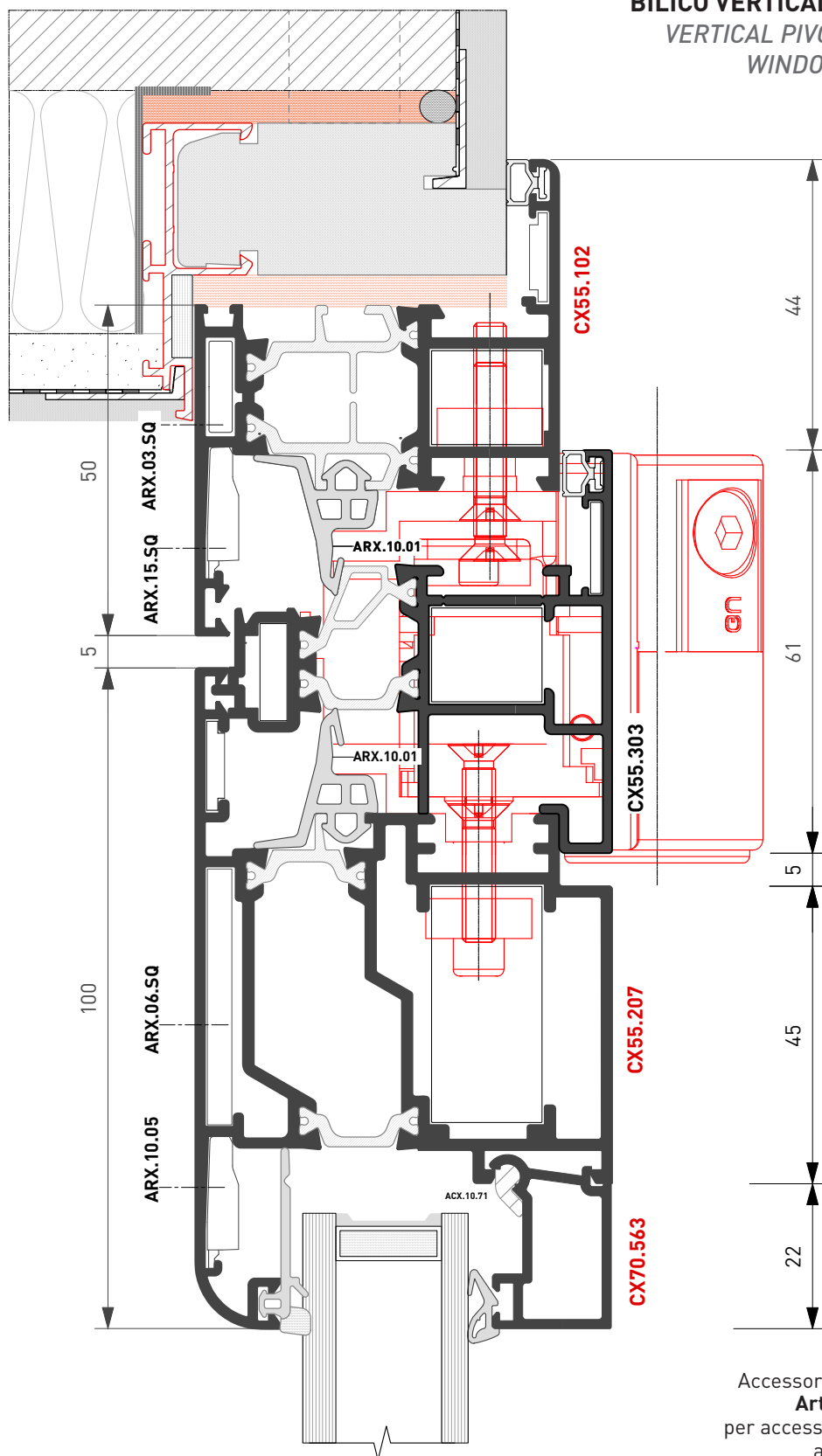
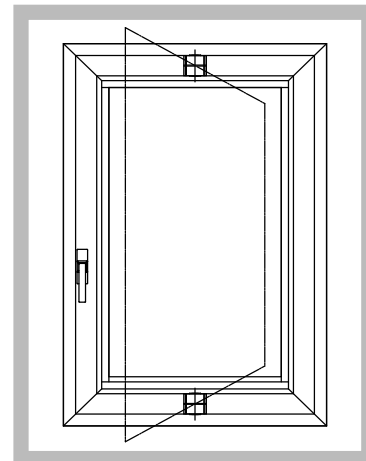

Accessorio Frizione **GU ITALIA U - 88**
Articolo 6 - 27337- 08 - P
 per accessori di movimentazione riferirsi
 alla tavola di assieme
Friction Item GU ITALIA U - 88
Item 6 - 27337- 08 - P
 for movement accessories refer to overview table



ELEMENTO FISSO
FIXED GLASS

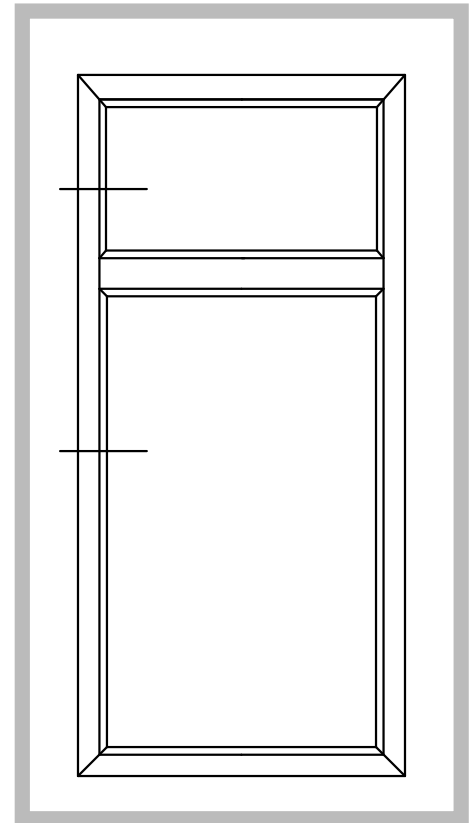
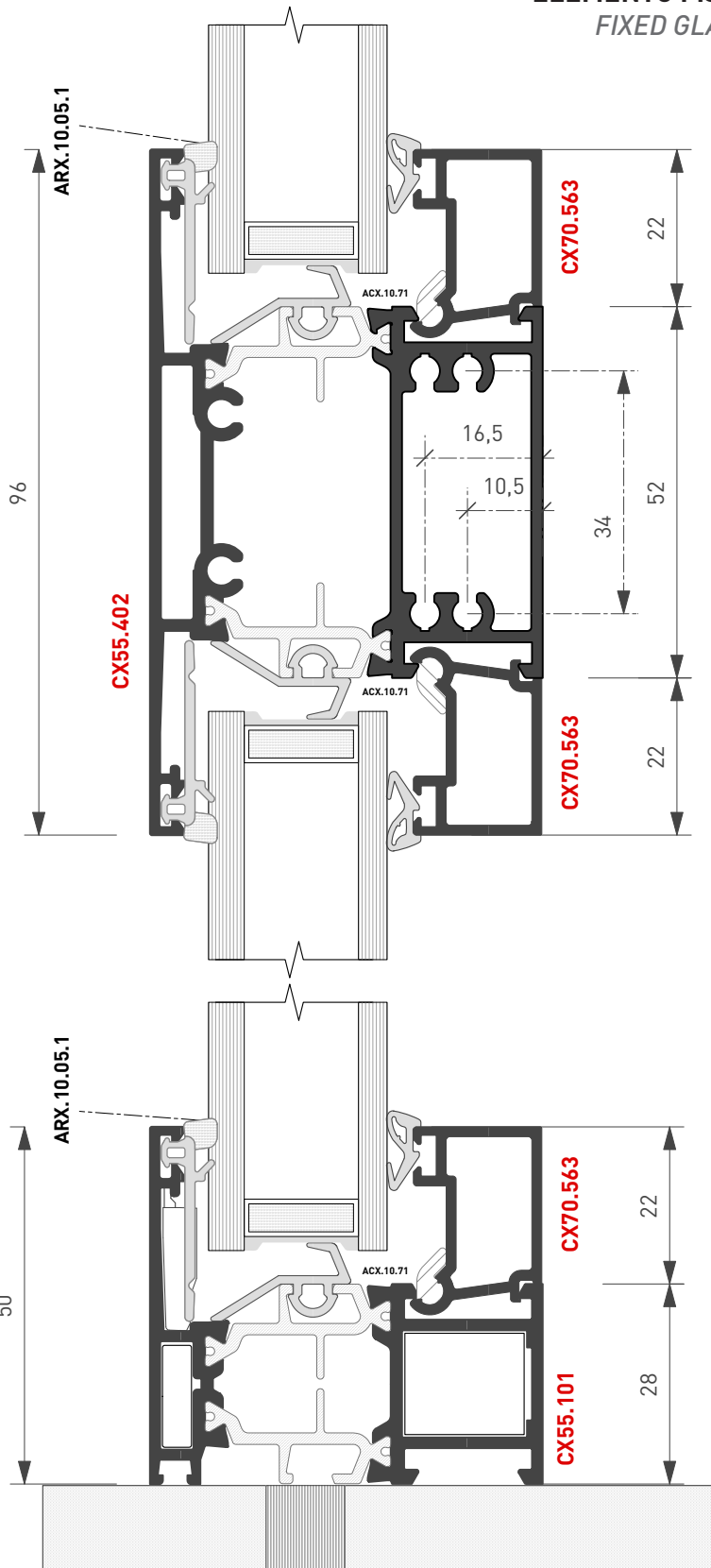



Ferramenta a Nastro
Tape Hardware

FINESTRA A 2 ANTE
DOUBLE SASH WINDOW

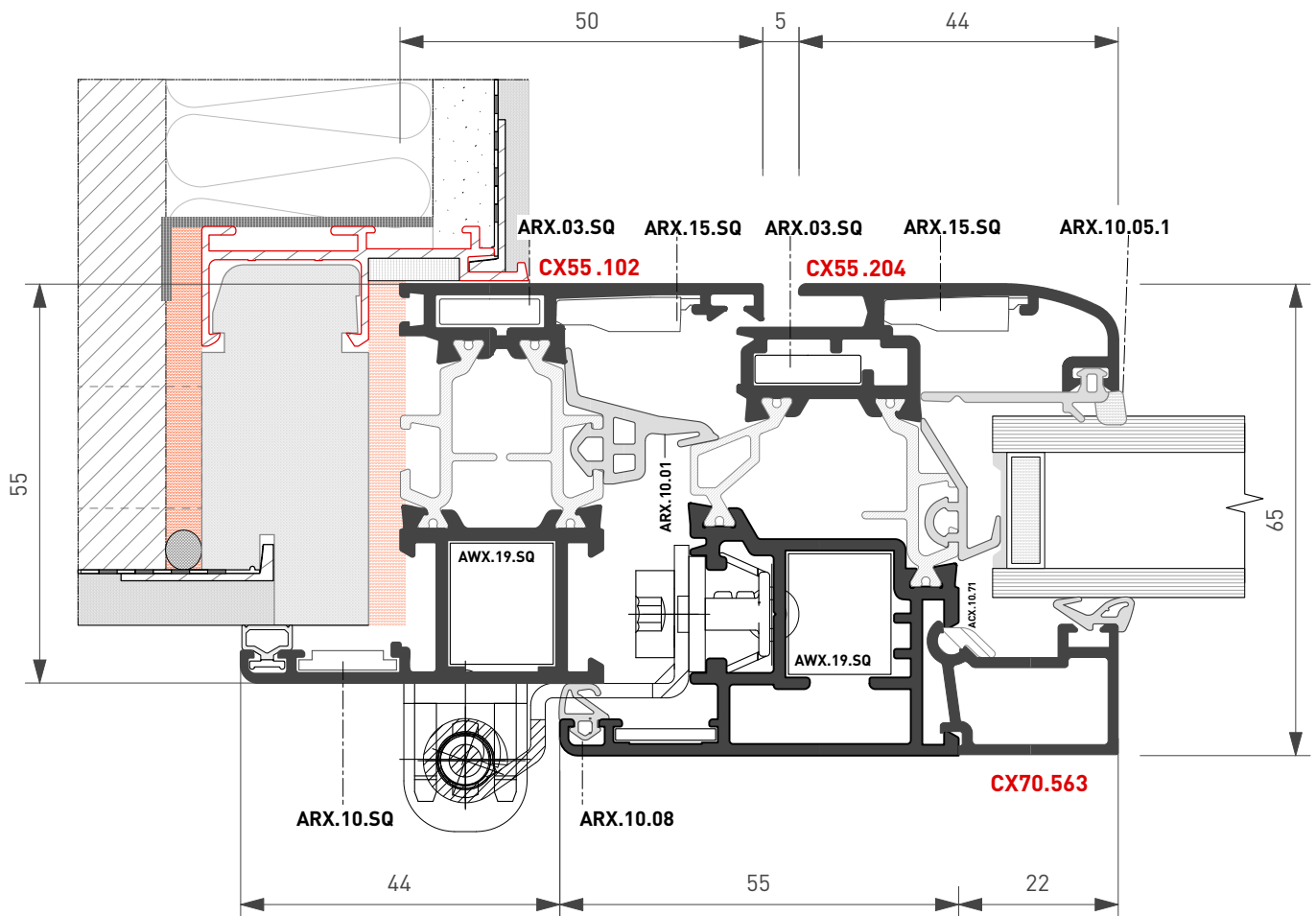
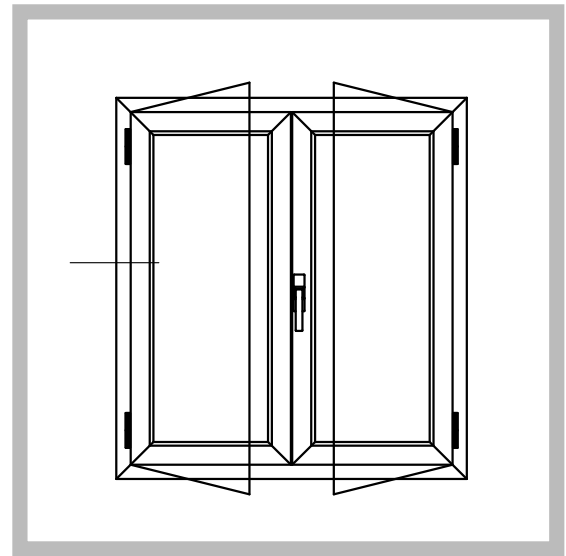



Ferramenta a Nastro
Tape Hardware

FINESTRA A 2 ANTE
DOUBLE SASH WINDOW

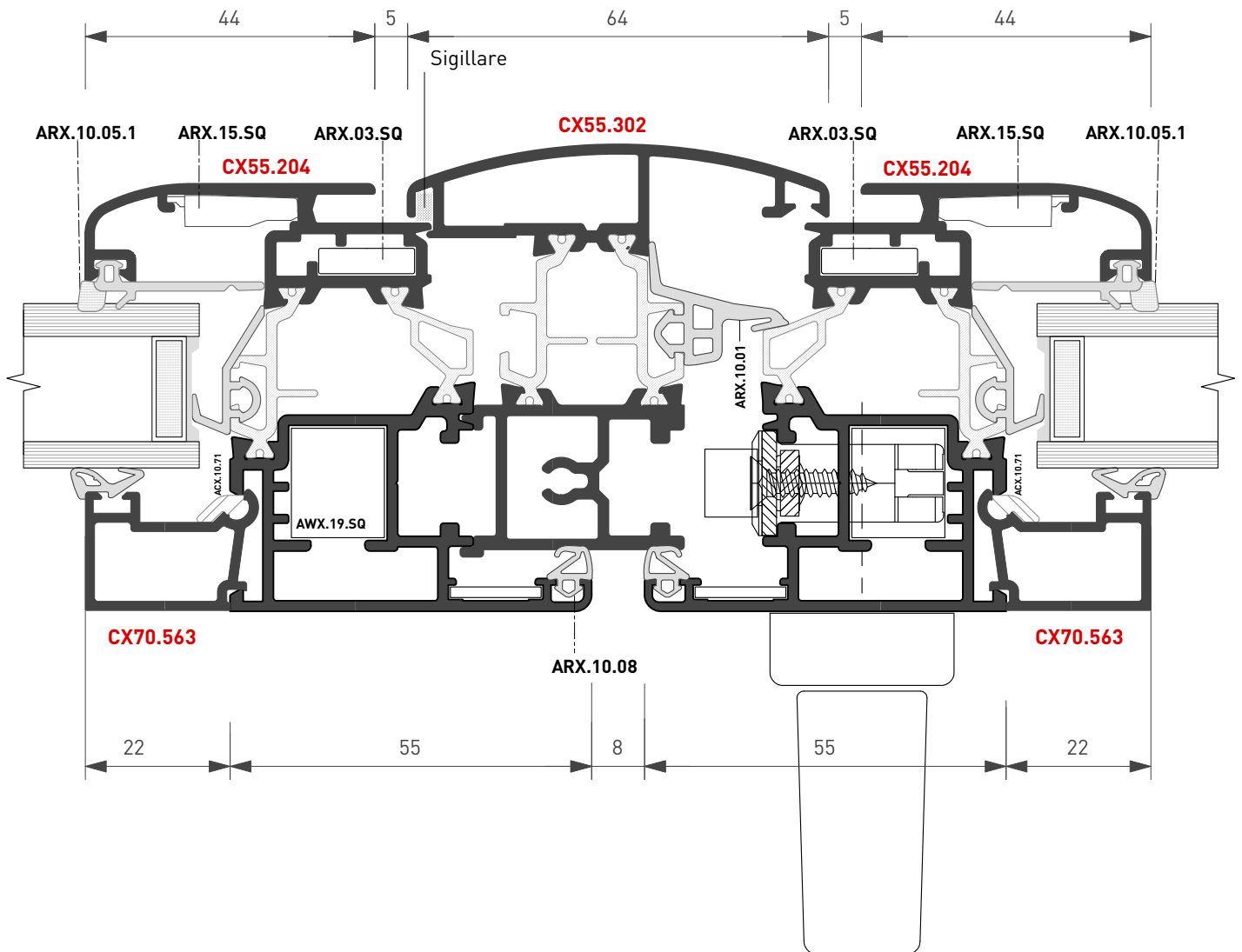
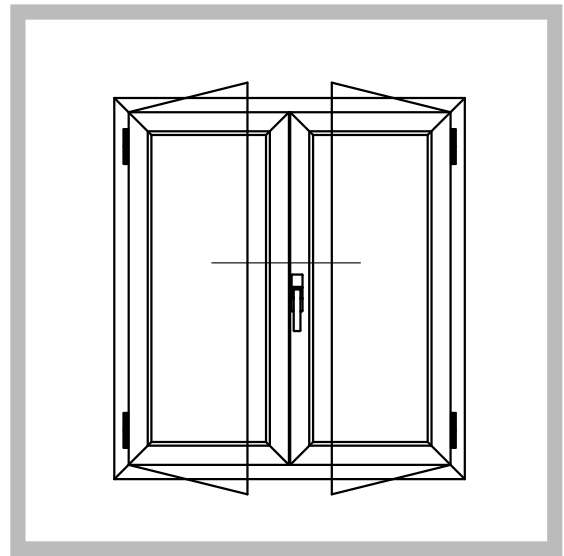



FINESTRA A 2 ANTE
Scorrevole in parallelo
DOUBLE SASH WINDOW
Parallel Sliding

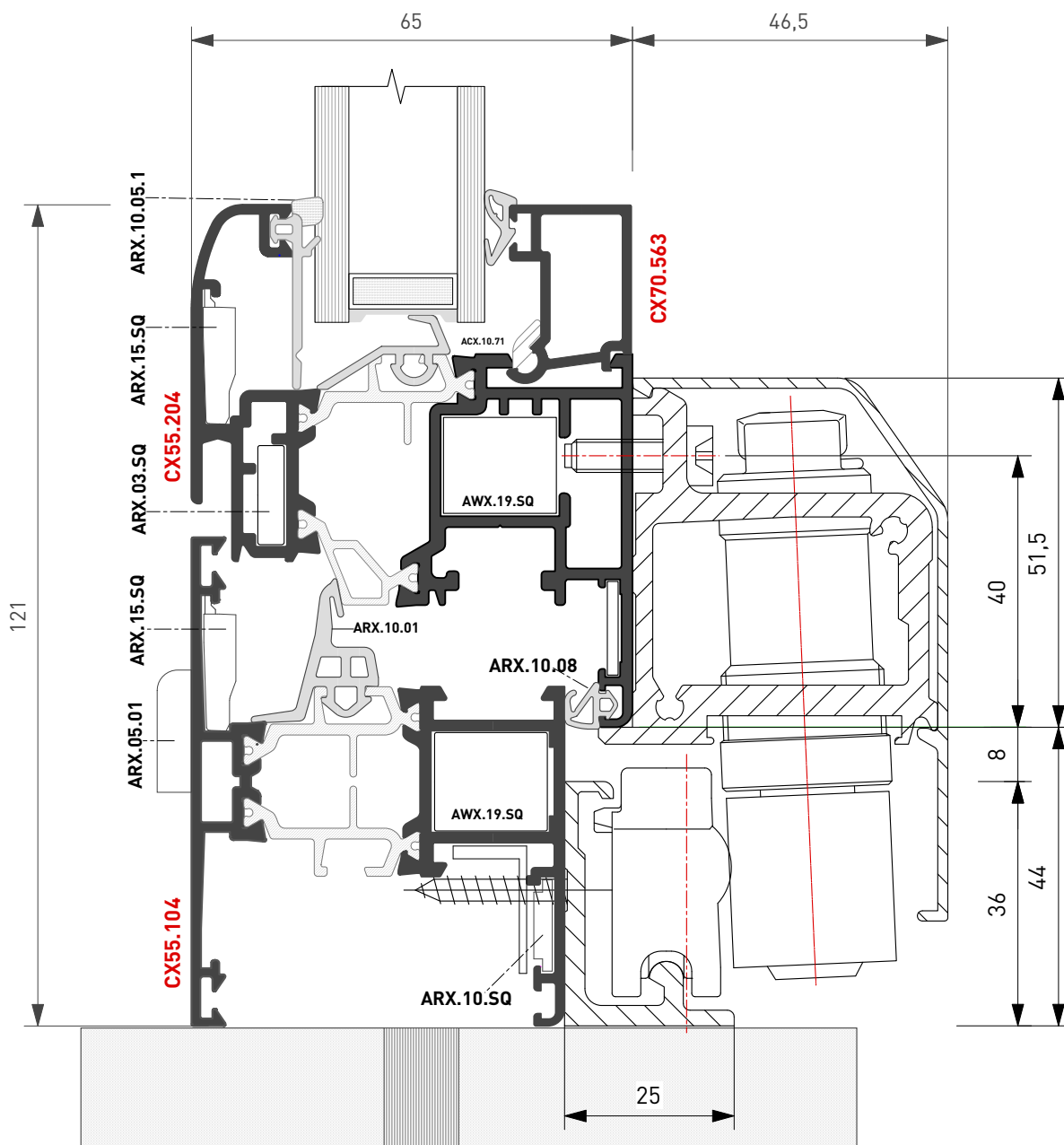
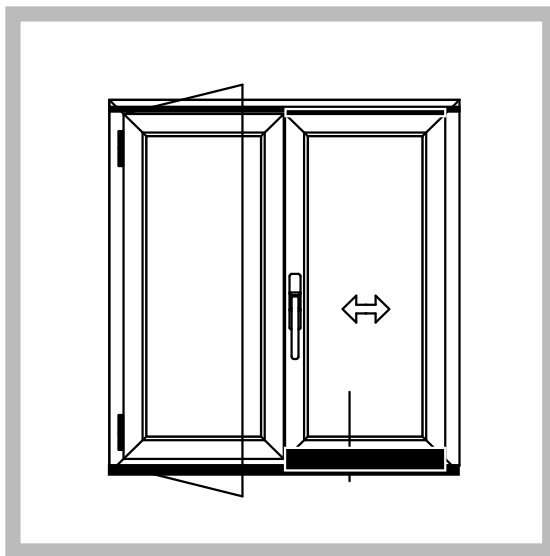



Ferramenta a Nastro
Tape Hardware

FINESTRA A 2 ANTE
Scorrevole in parallelo
DOUBLE SASH WINDOW
Parallel Sliding

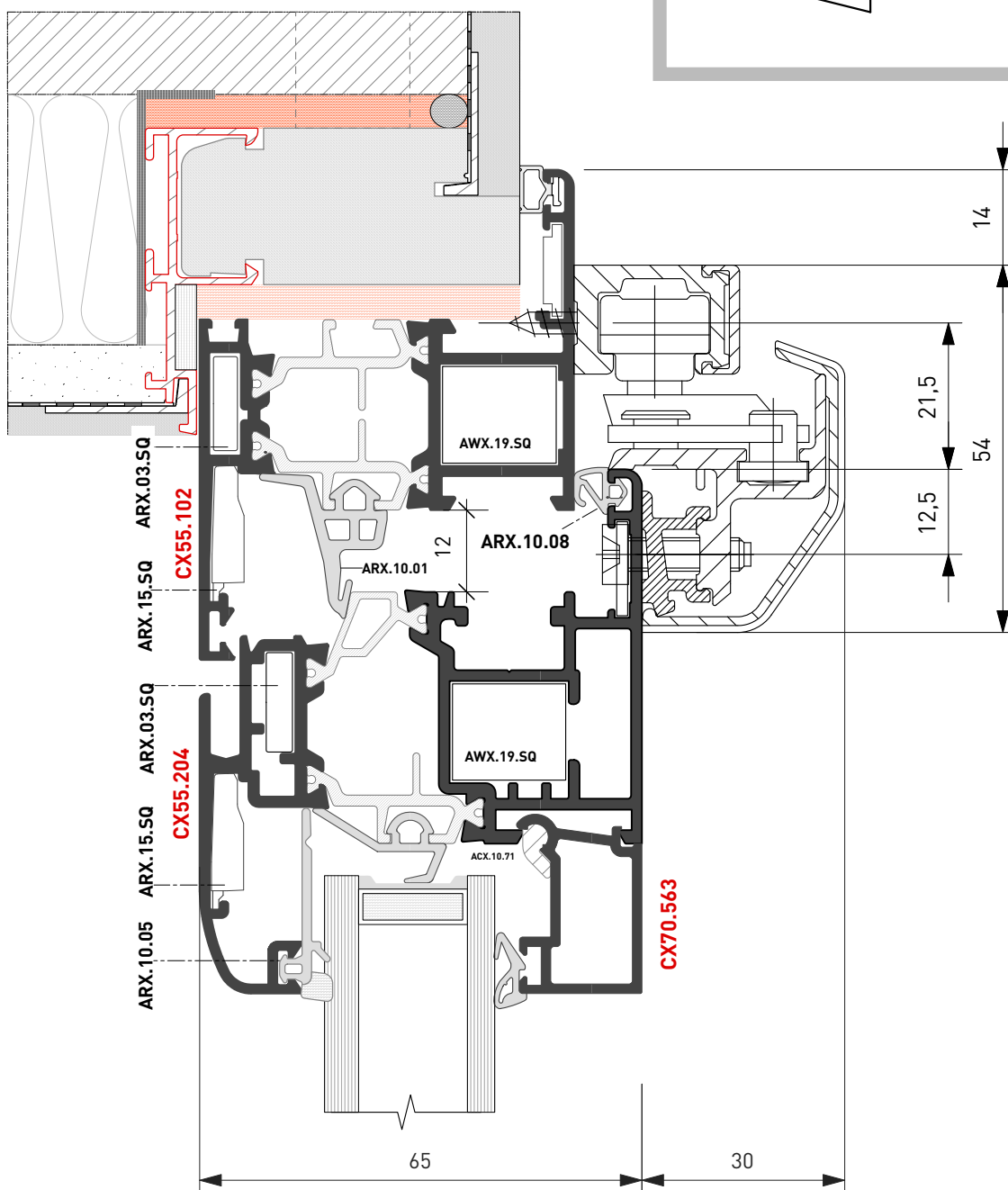
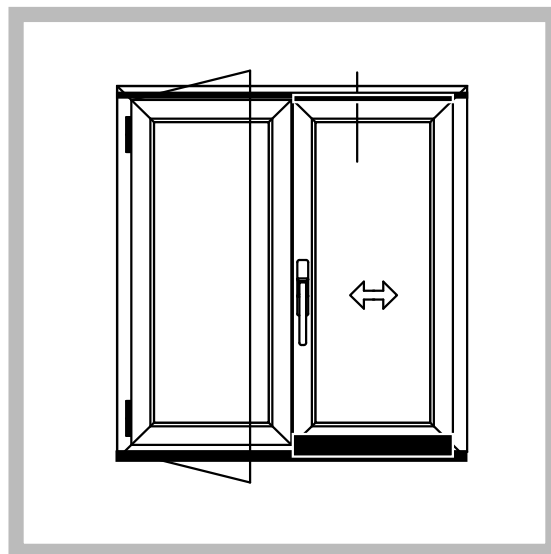



Ferramenta a Nastro
Tape Hardware

PORTA BALCONE A 2 ANTE
DOUBLE SASH BALCONY DOOR

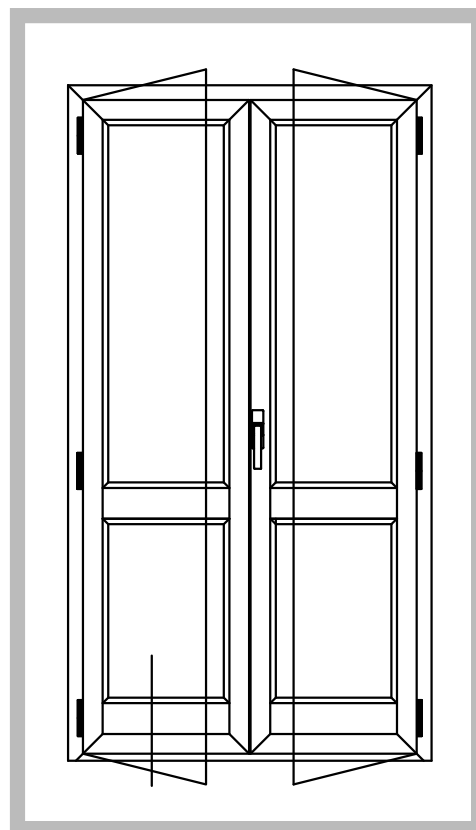
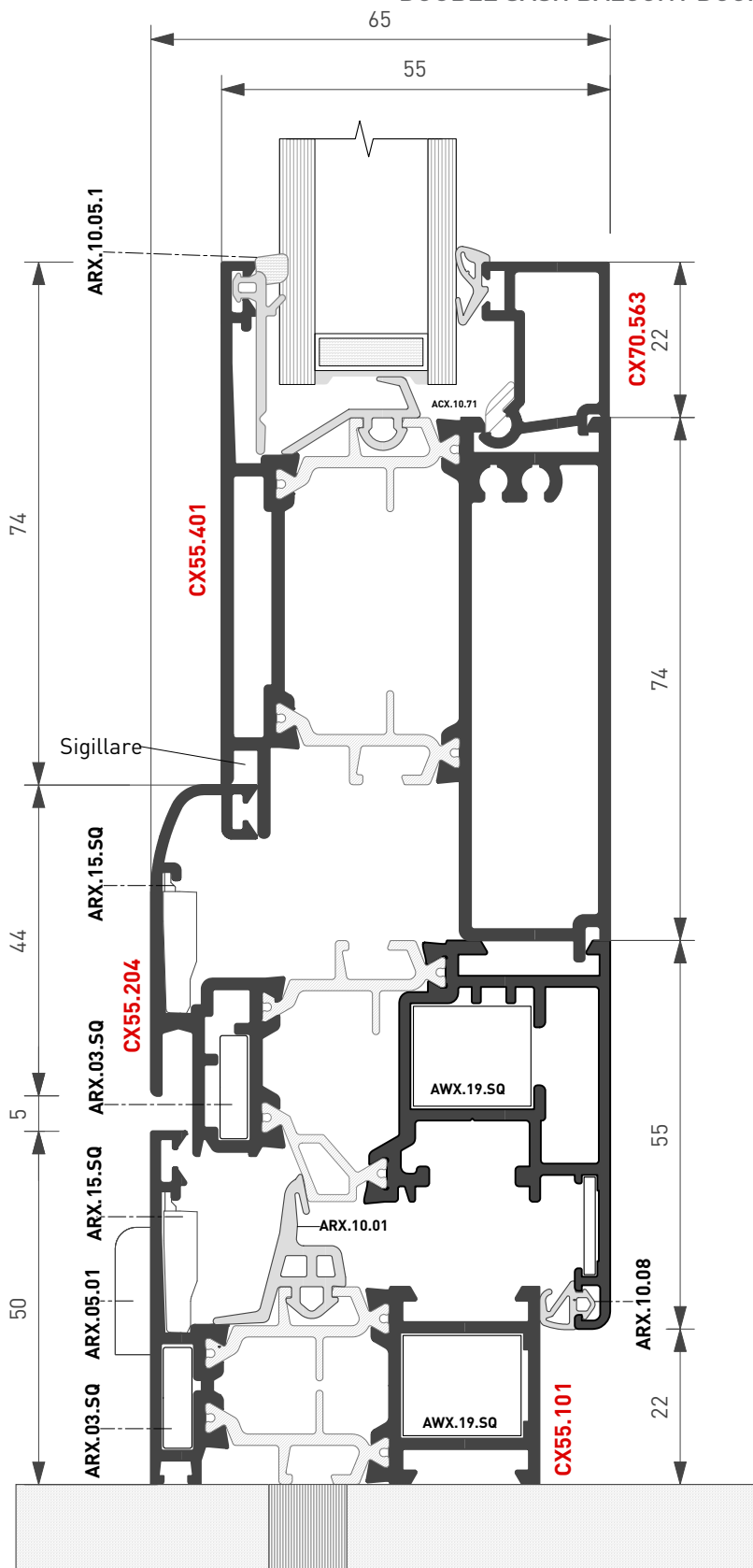



Ferramenta a Nastro
Tape Hardware

PORTA BALCONE A 2 ANTE
DOUBLE SASH BALCONY DOOR

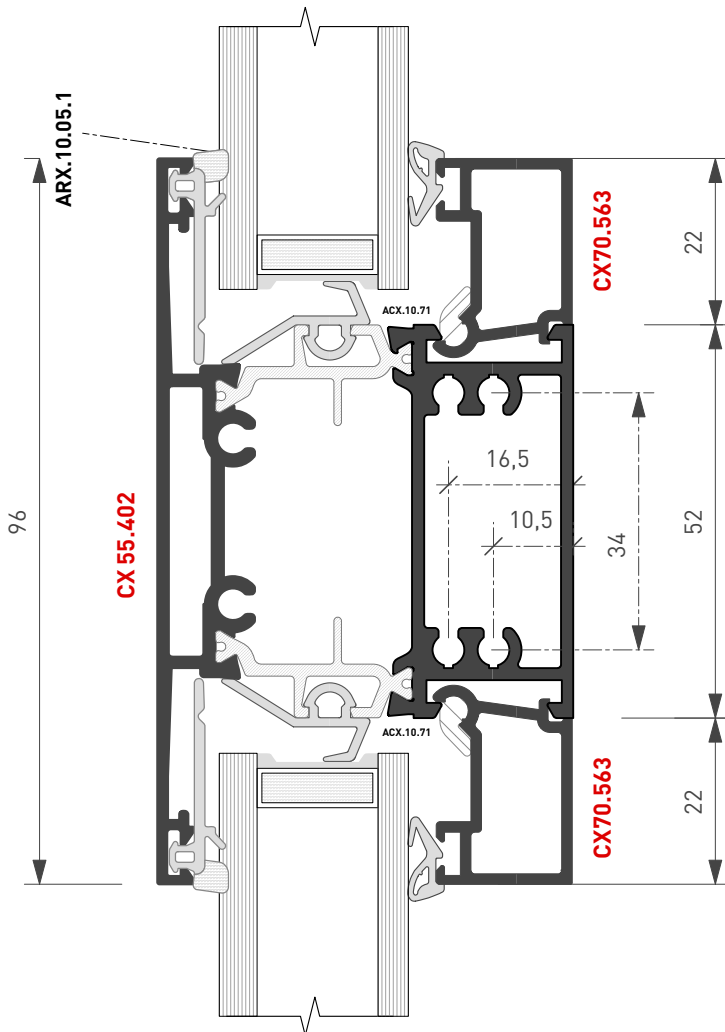
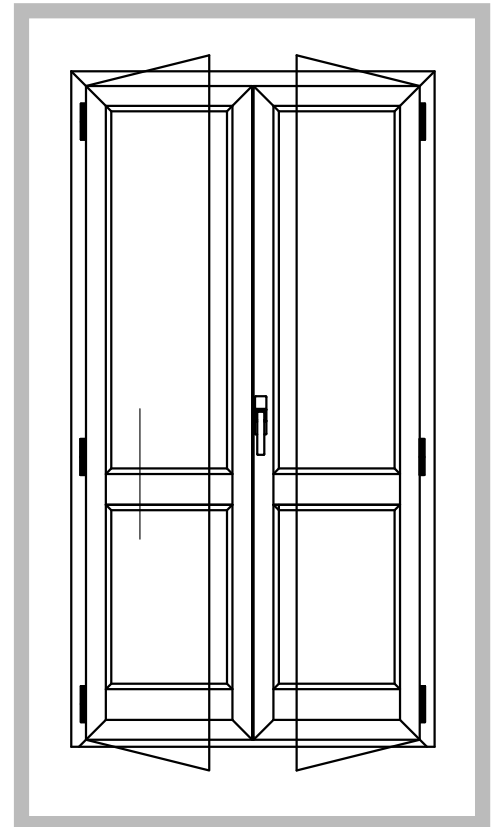



**FINESTRA
BILICO ORIZZONTALE**
HORIZONTAL PIVOT
WINDOW

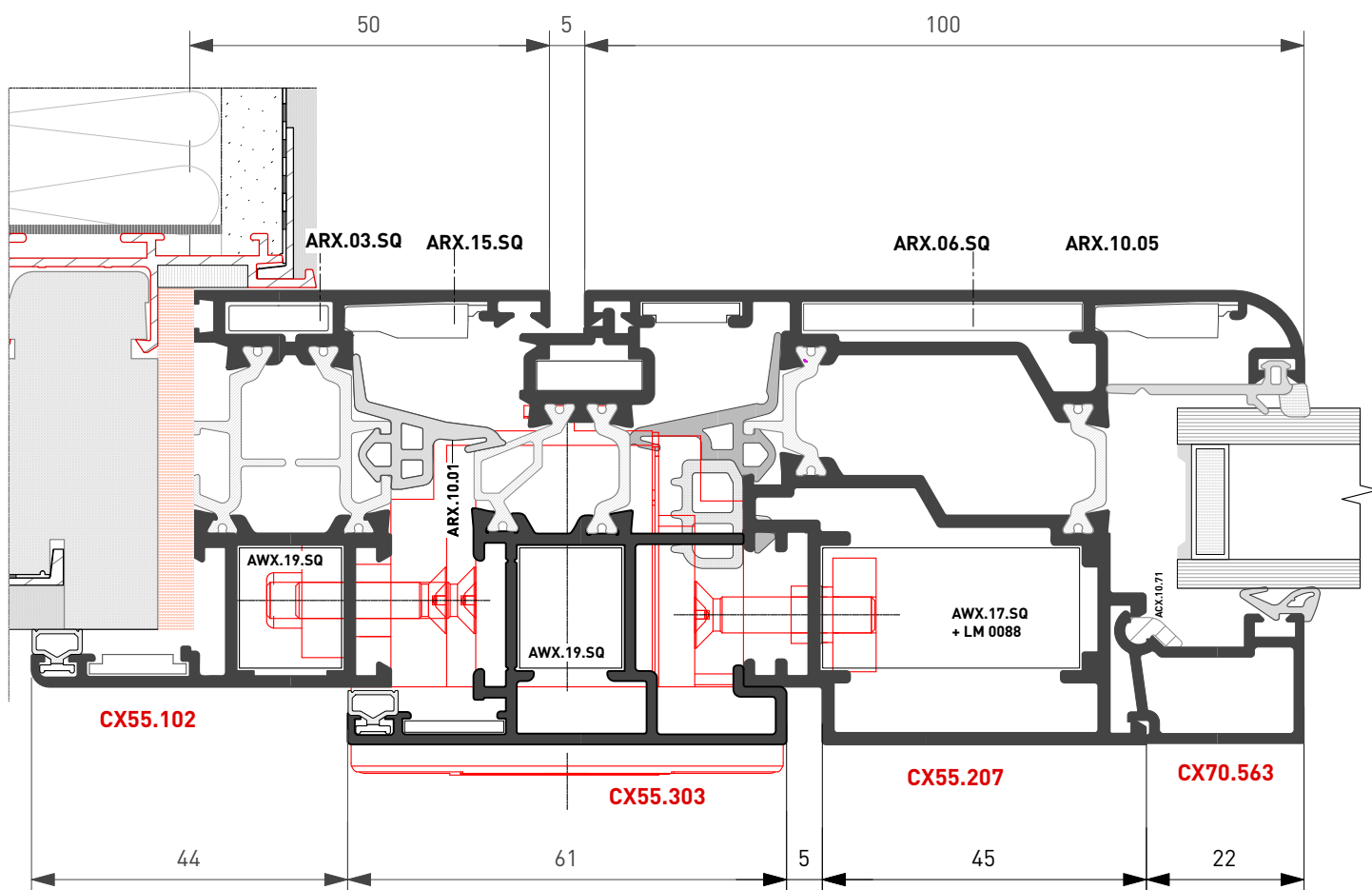
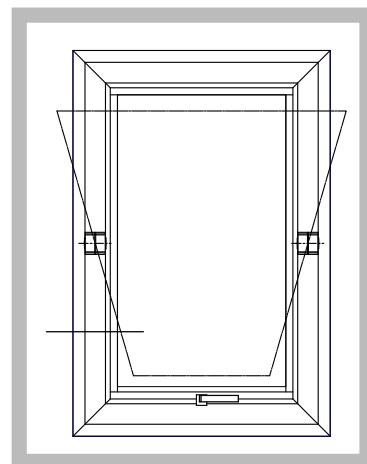

Accessorio Frizione **GU ITALIA U - 18/3**
Articolo 6 - 27212-07 - P
per accessori di movimentazione riferirsi
alla tavola di assieme
Friction Item GU ITALIA U - 88
Item 6 - 27212-07 - P
for movement accessories refer to overview table



ABBINAMENTO CON SCORREVOLE SX 700
Telaio in appoggio
COMBINATION WITH SX700 SLIDING DOOR
On fixed frame

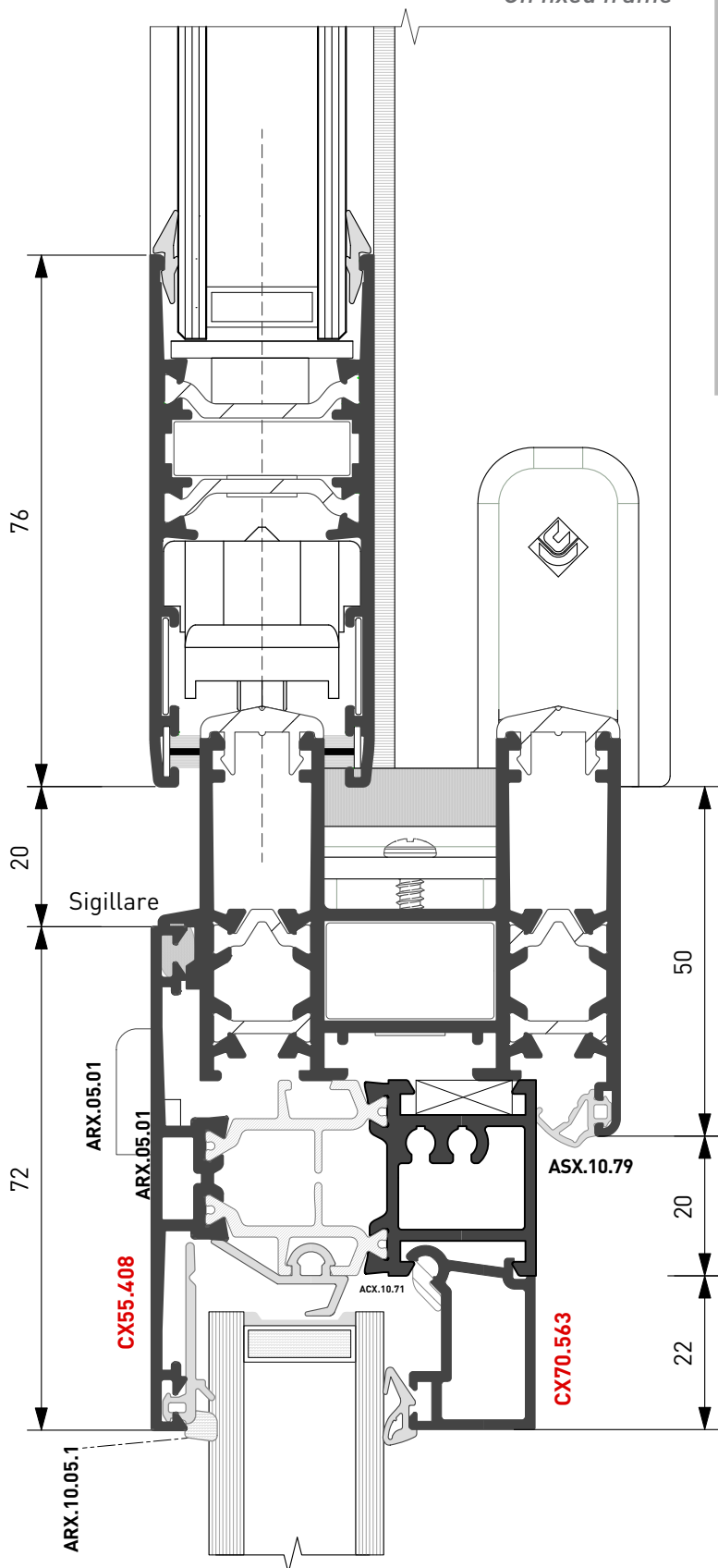
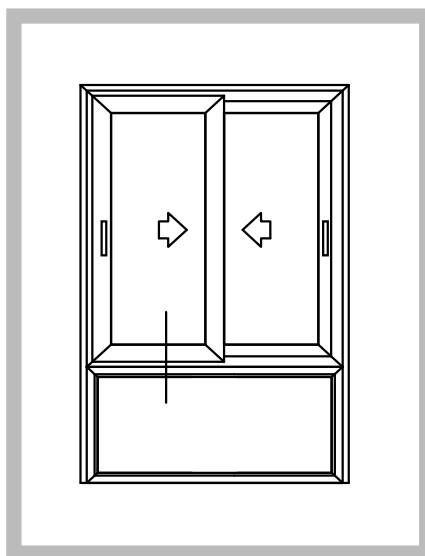

Per i riferimenti della serie SX 700
consultare il relativo catalogo.
Referer to SX 700 series catalog



TELAIO CAPANNONI | INDUSTRIAL SHED FRAME

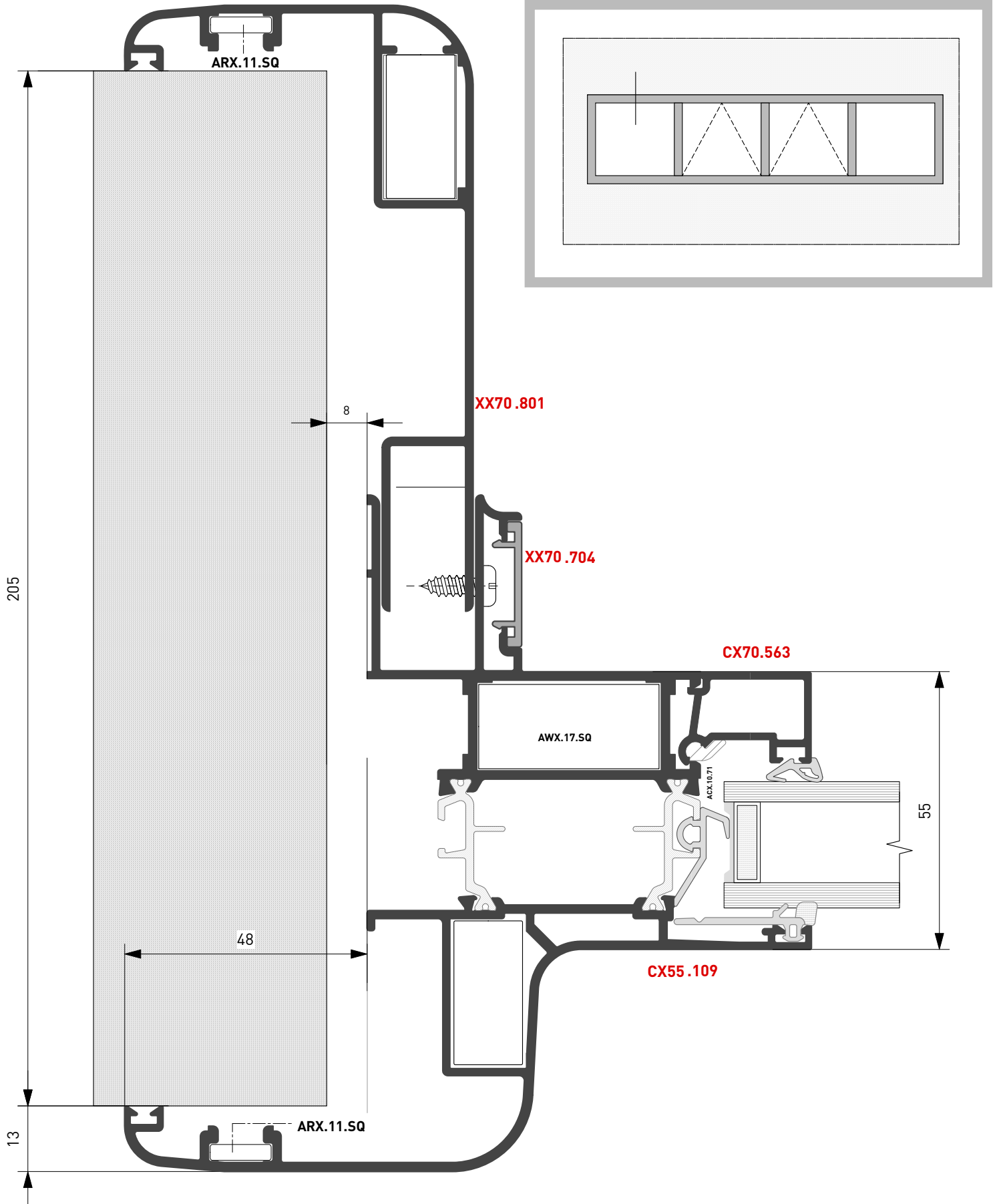



TELAIO CAPANNONI | INDUSTRIAL SHED FRAME

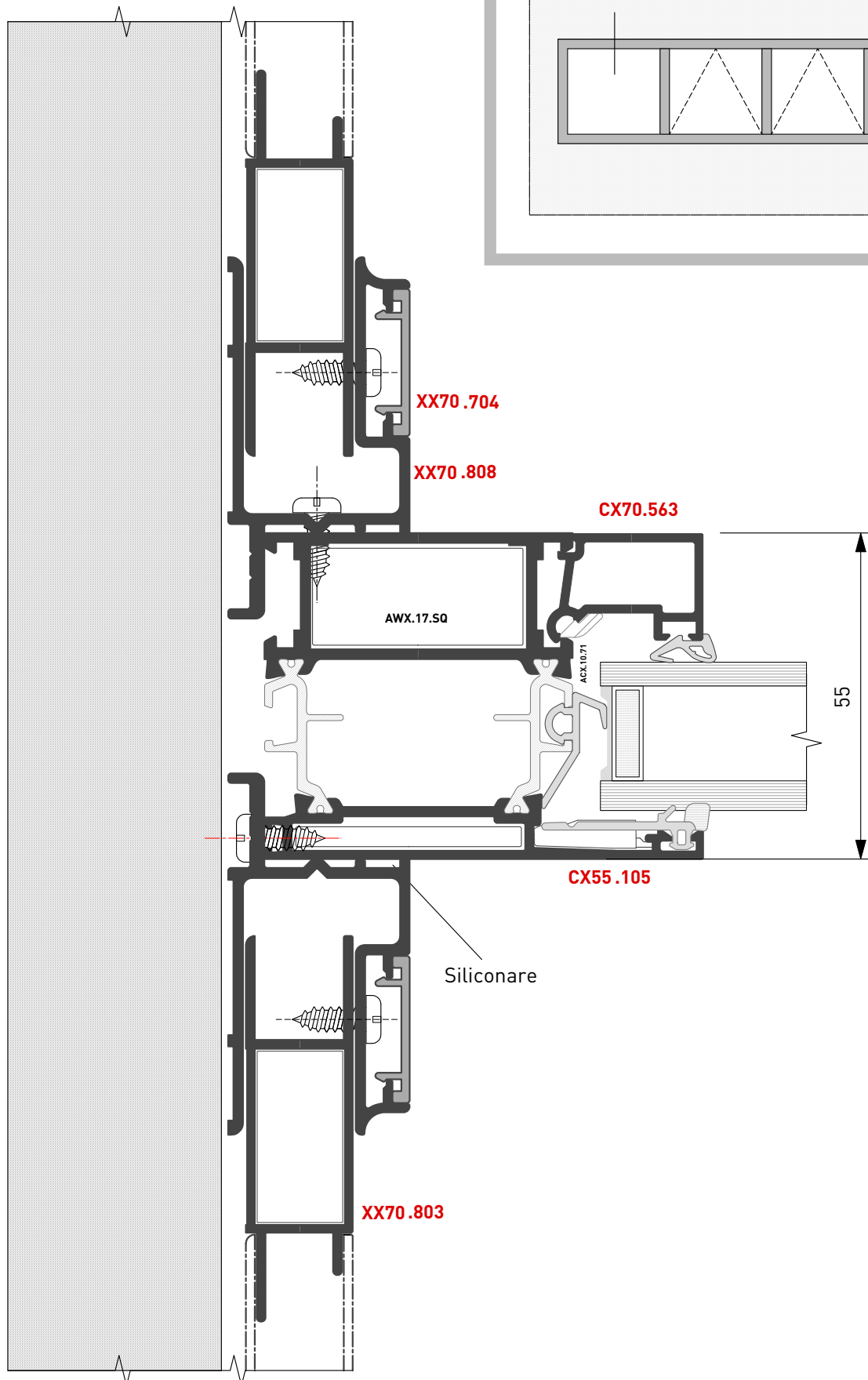



TELAI COMPENSAZIONE
LEVELLING FRAME

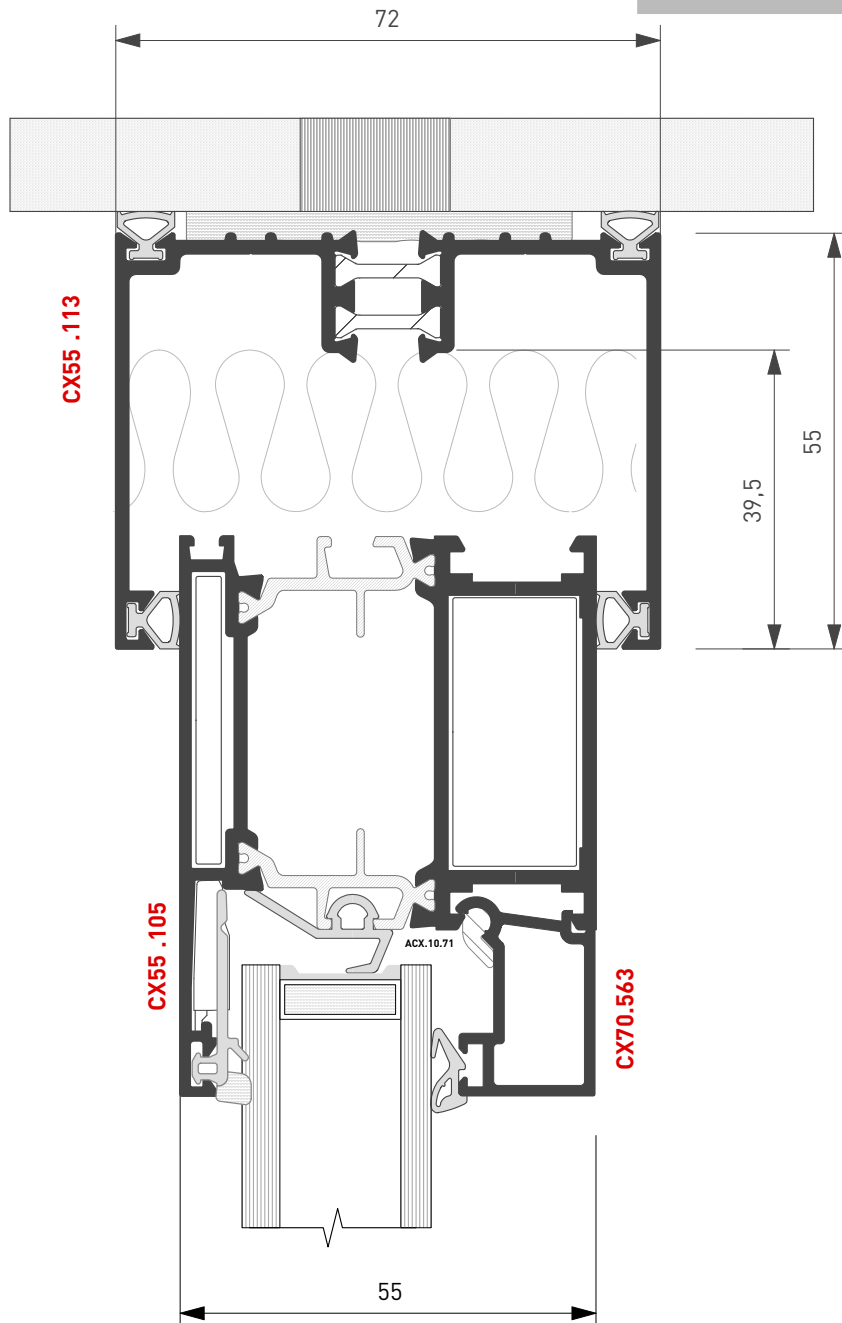
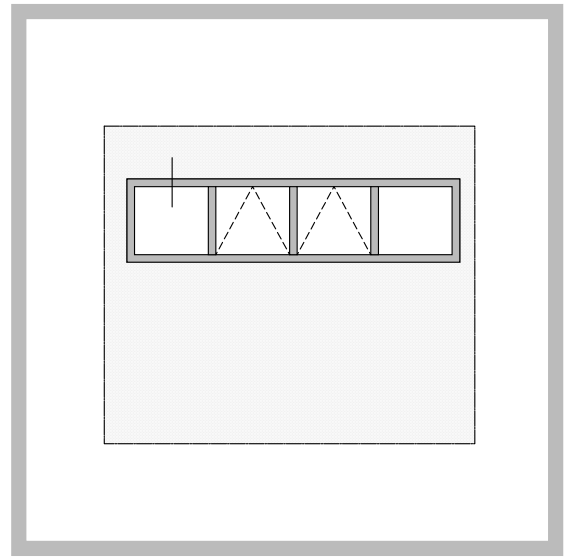



PROFILO UNIVERSALE PER ANGOLO A 90°
UNIVERSAL PROFILE FOR 90° CORNER

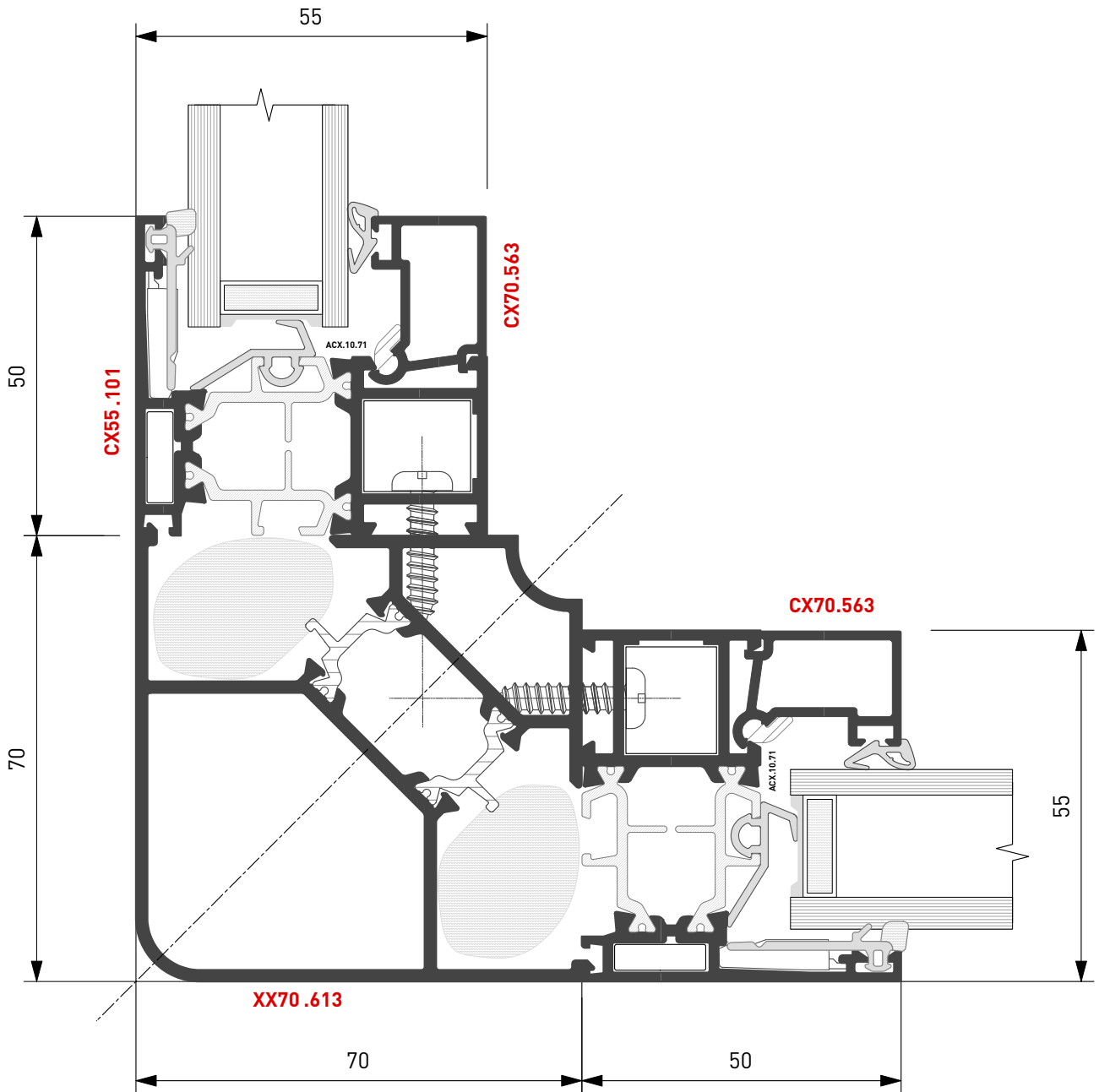



PORTA DI INGRESSO A 2 ANTE
DOUBLE SASHES ENTRANCE DOOR

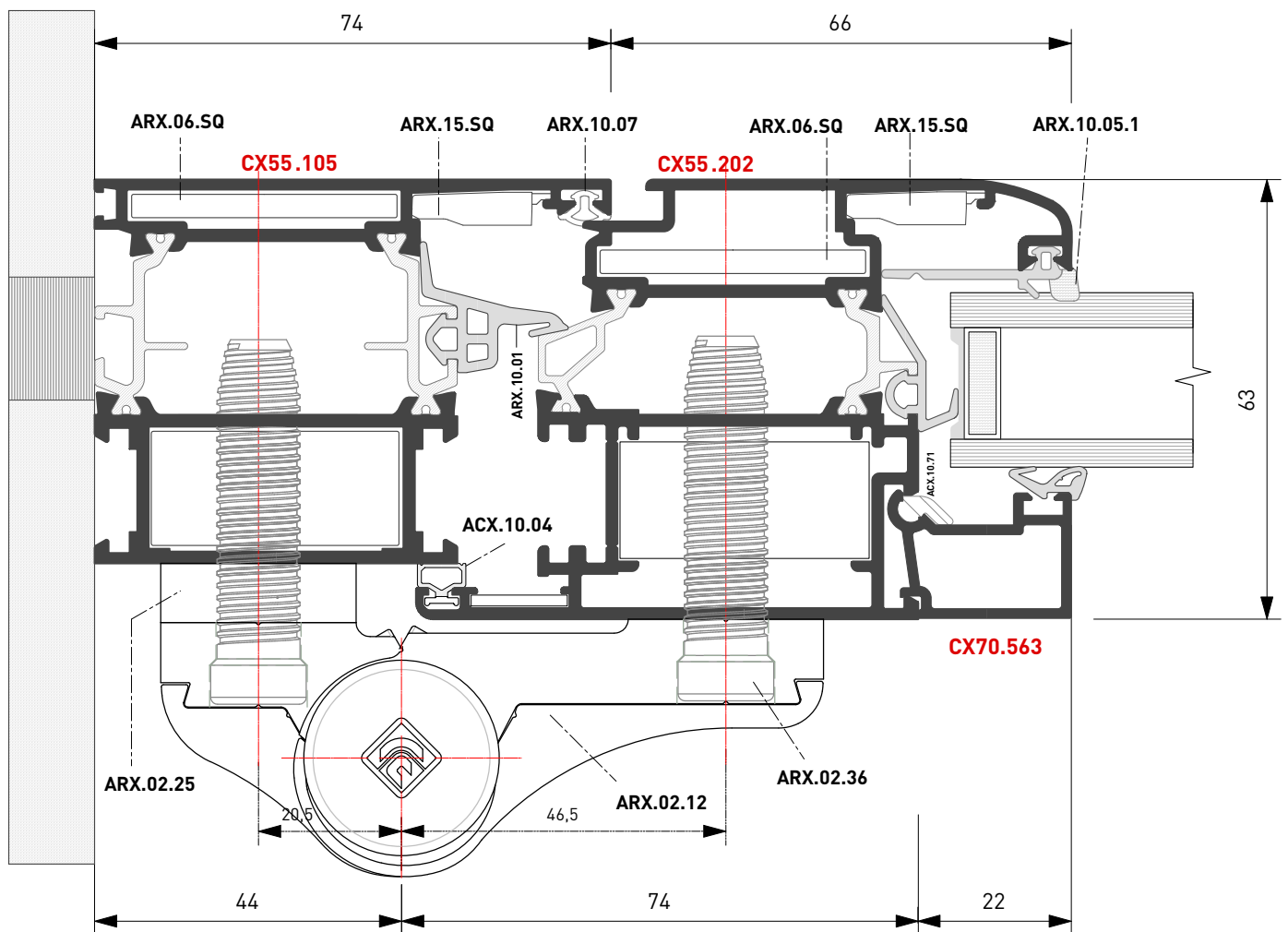
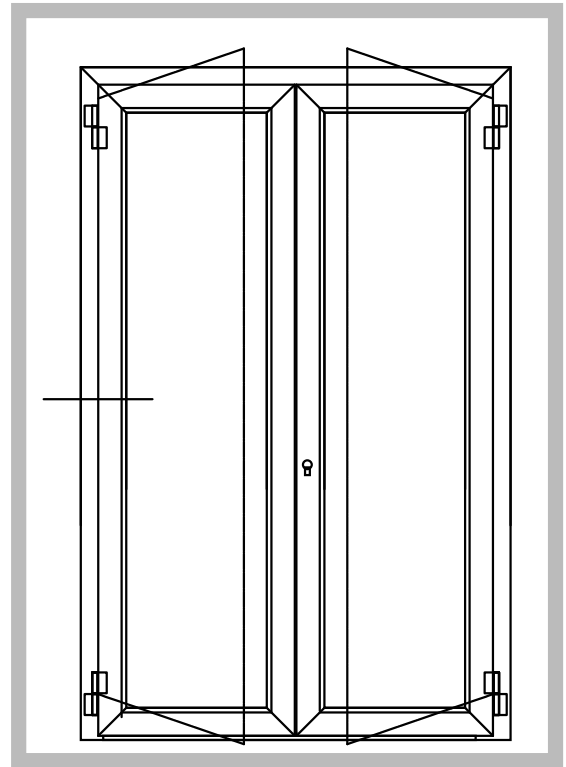

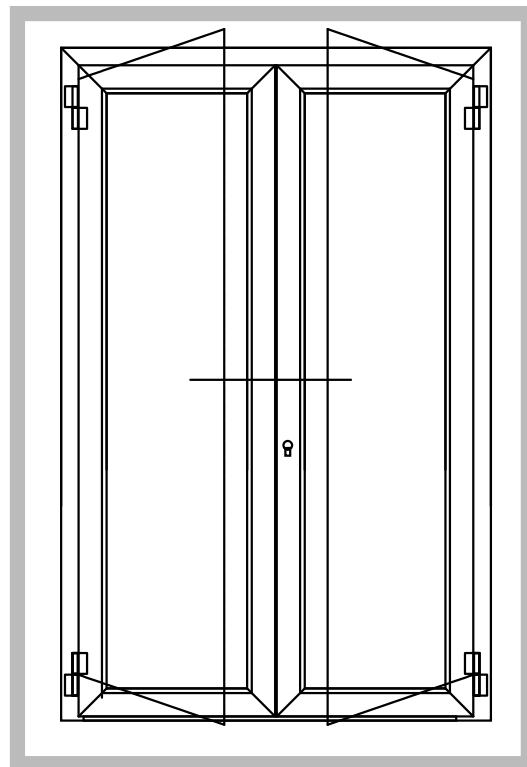
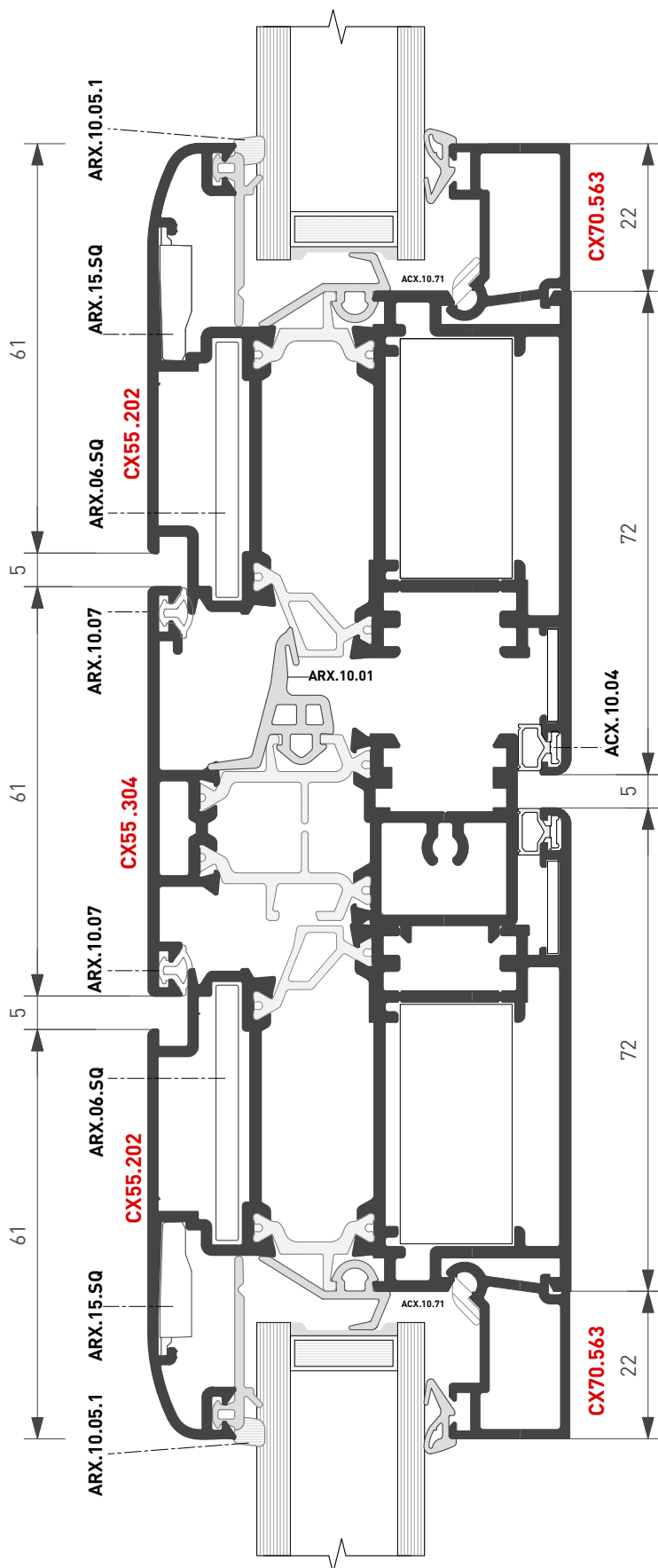

PORTA DI INGRESSO A 2 ANTE
DOUBLE SASHES ENTRANCE DOOR



PORTA DI INGRESSO AD UNA ANTA
SINGLE SASH ENTRANCE DOOR

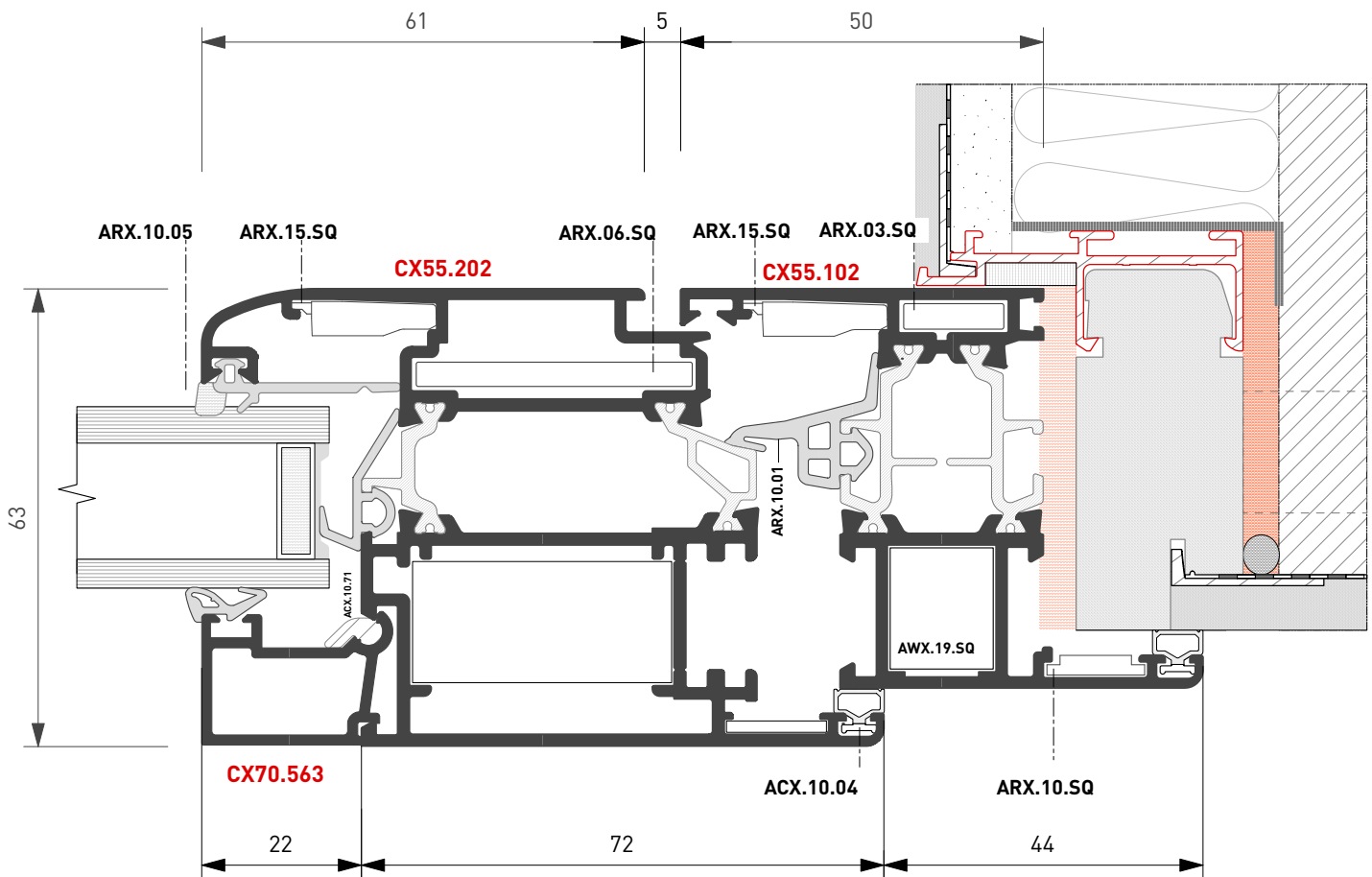
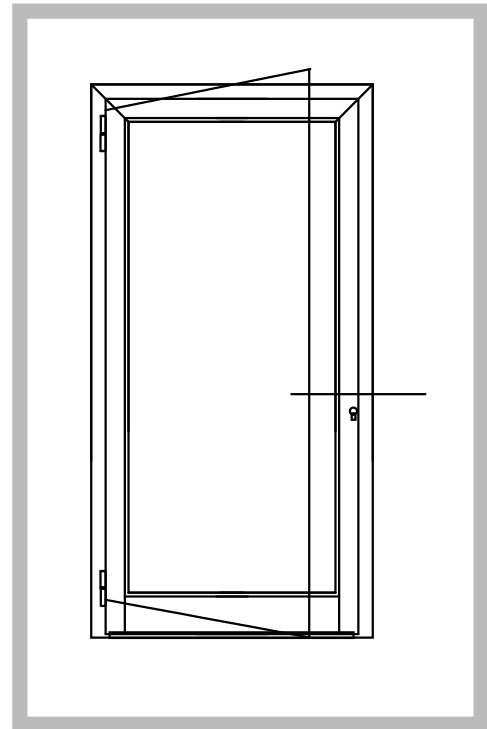

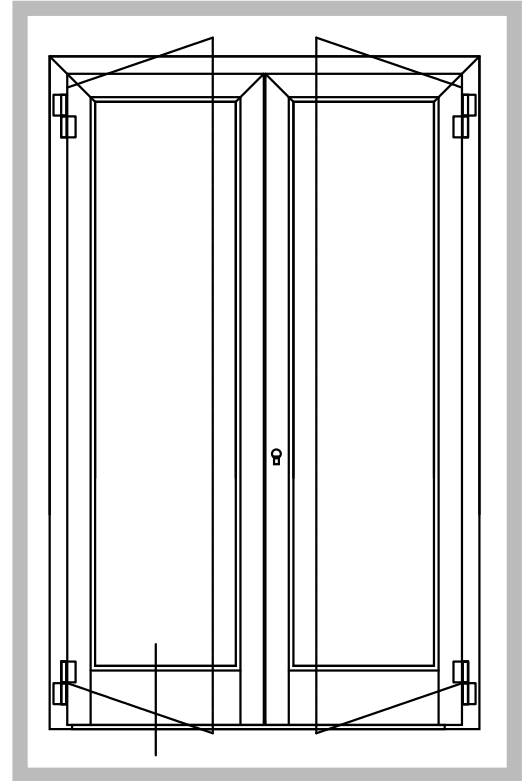
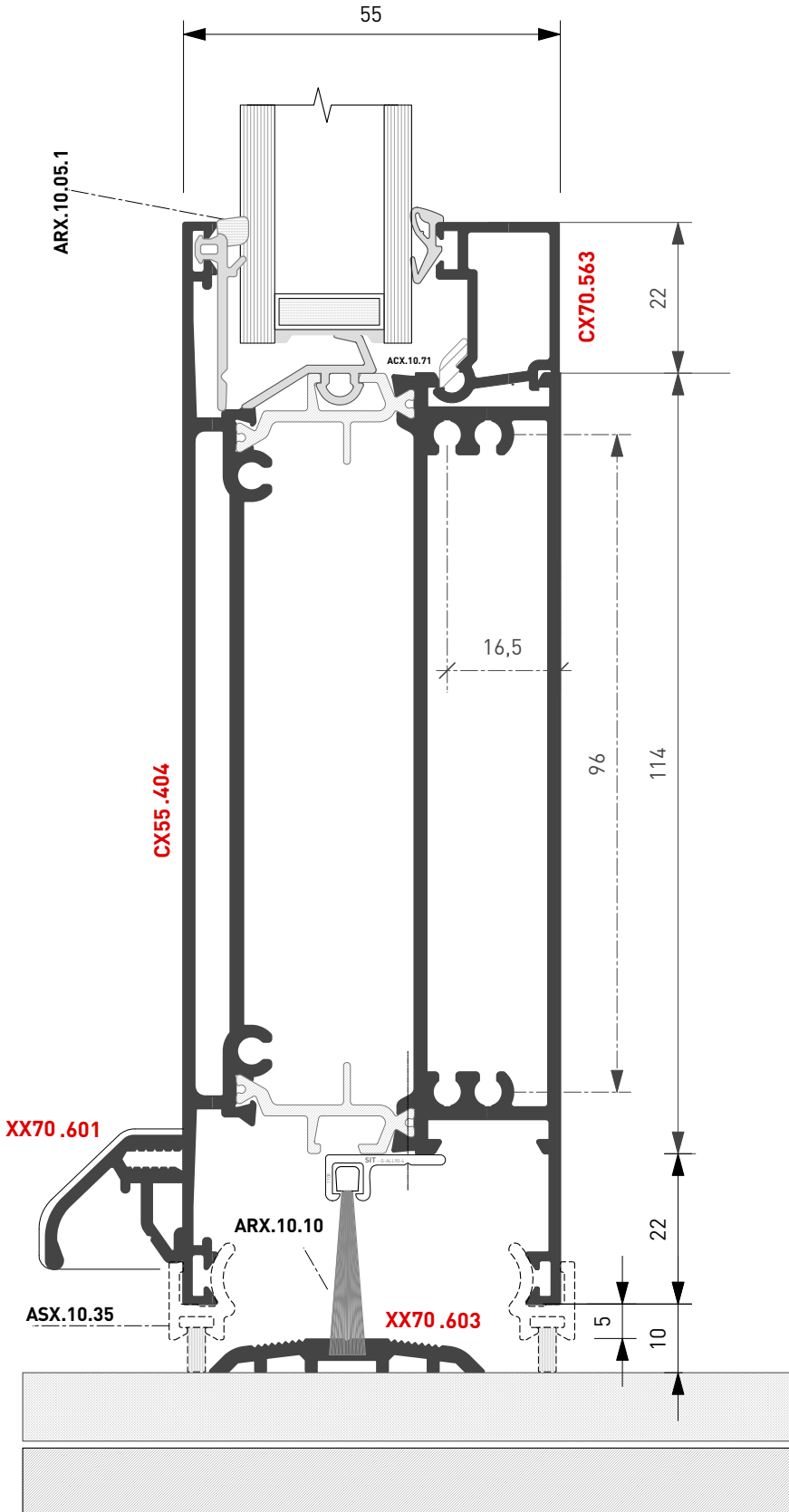

PORTA DI INGRESSO A 2 ANTE
DOUBLE SASHES ENTRANCE DOOR

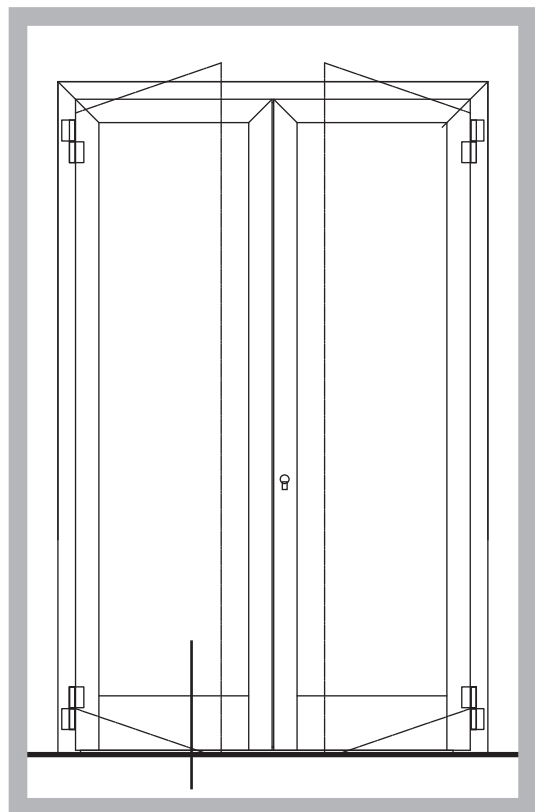
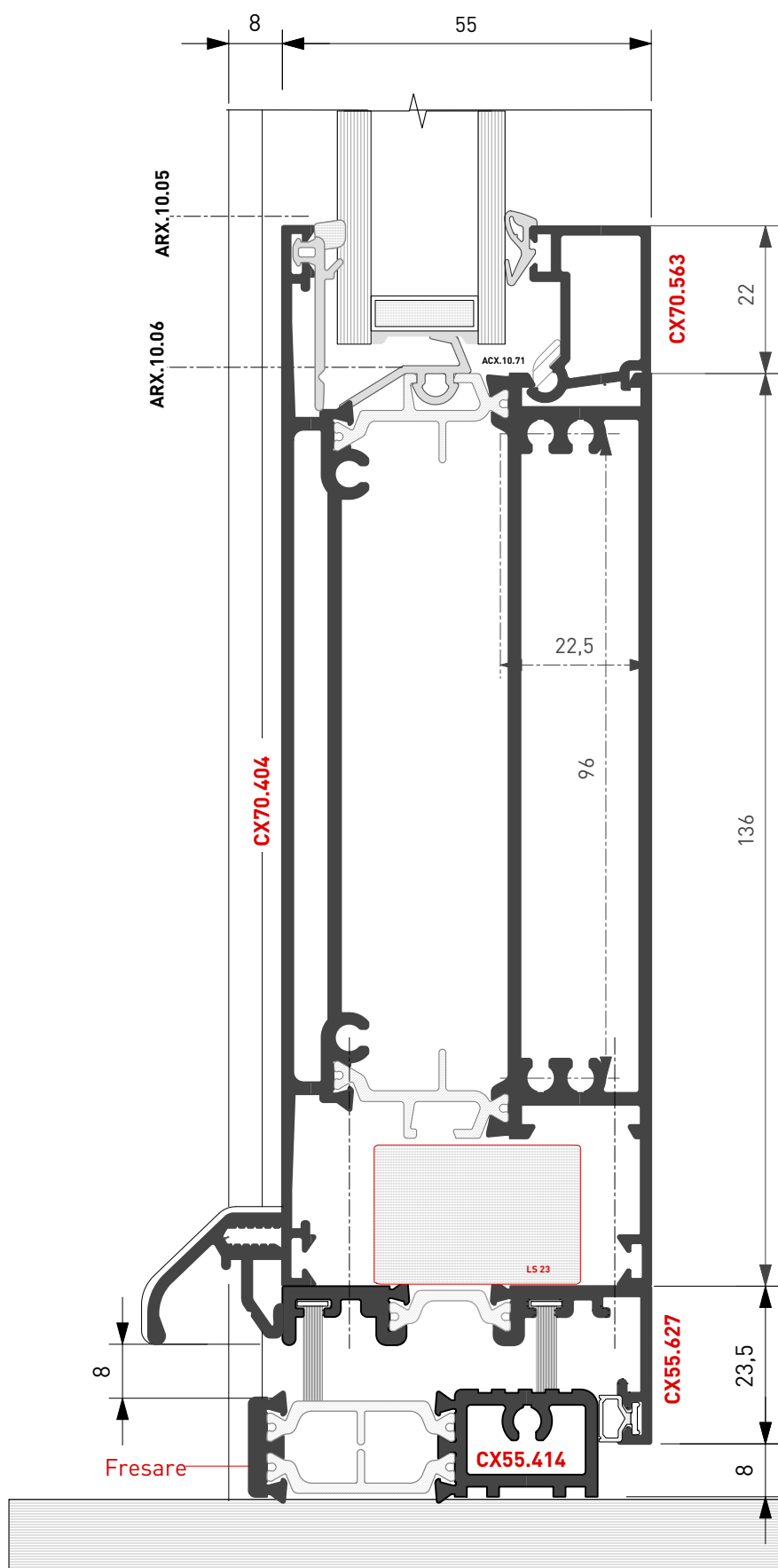

PORTA DI INGRESSO A 2 ANTE
Apertura Interna
DOUBLE SASHES ENTRANCE DOOR
Internal Opening

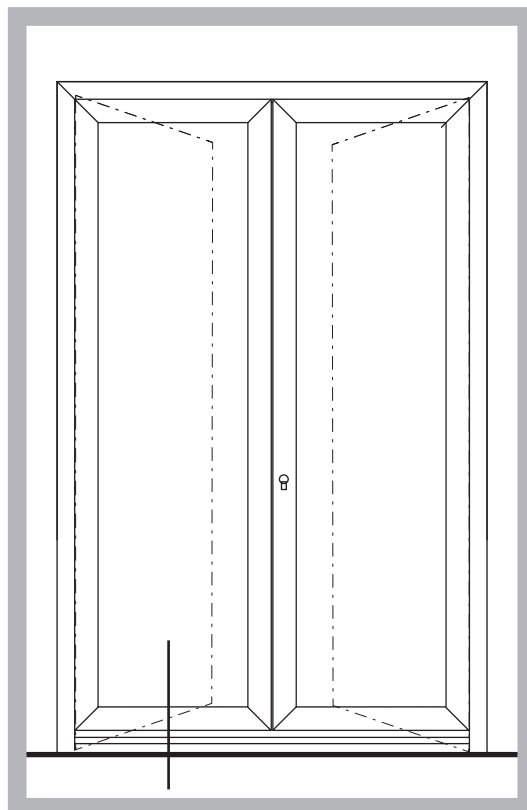

PORTA DI INGRESSO A 2 ANTE
Apertura esterna
DOUBLE SASHES ENTRANCE DOOR
External Opening

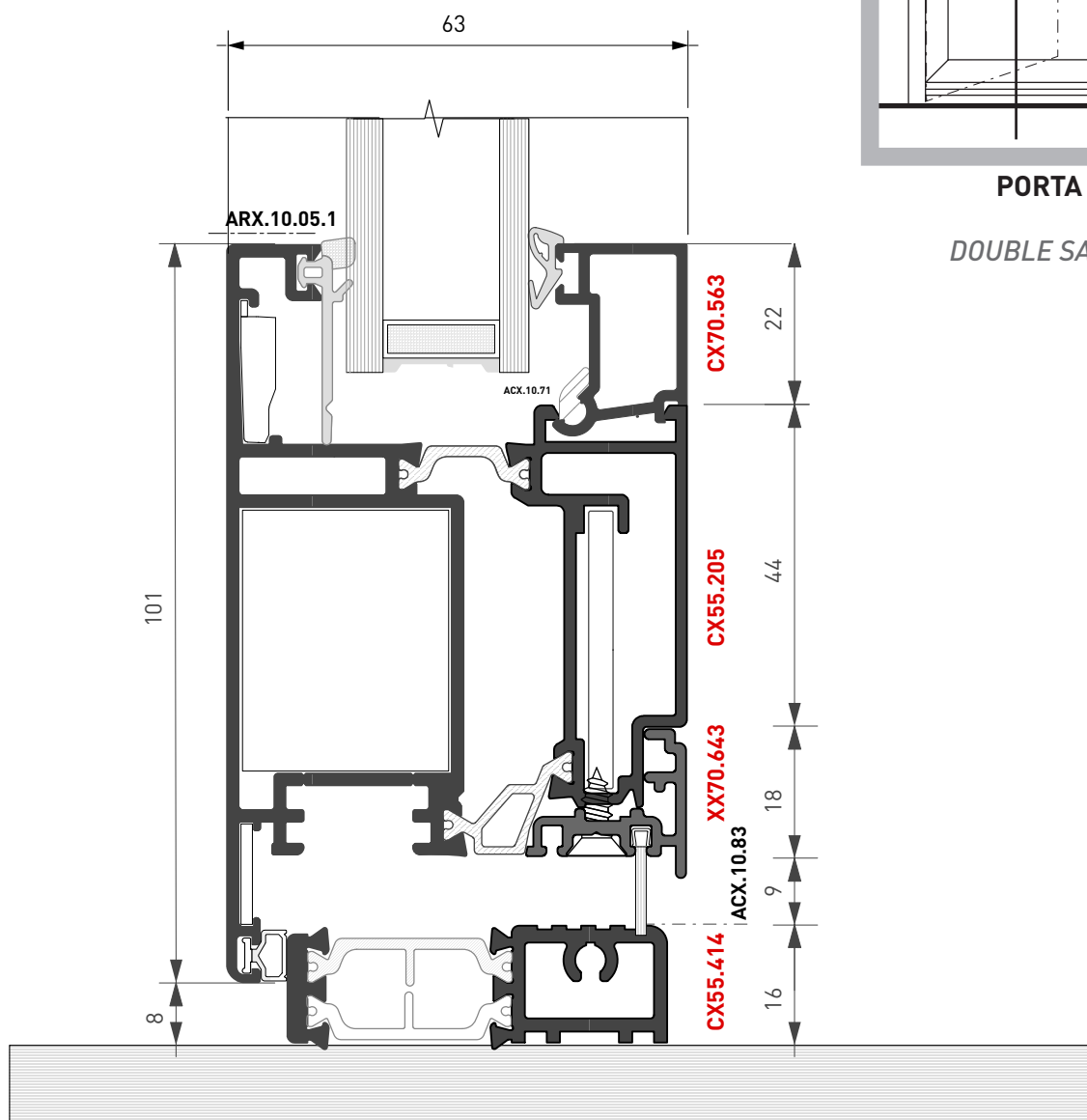

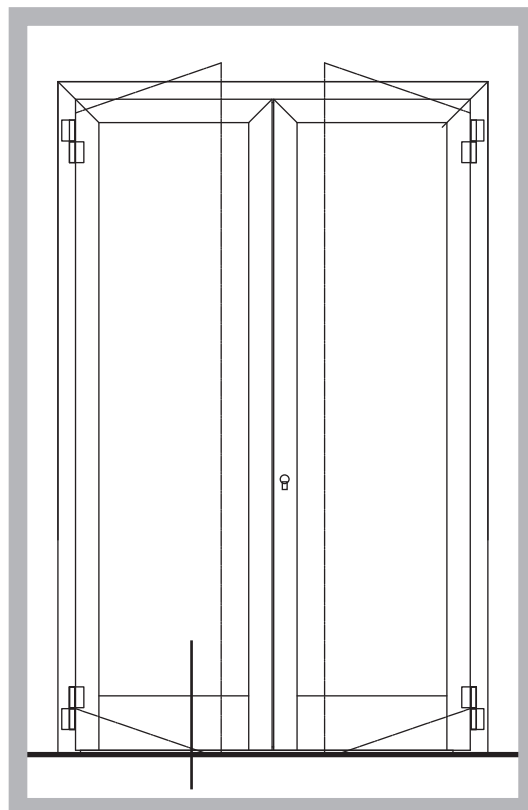

PORTA DI INGRESSO A 2 ANTE
Apertura Interna
DOUBLE SASHES ENTRANCE DOOR
Internal Opening

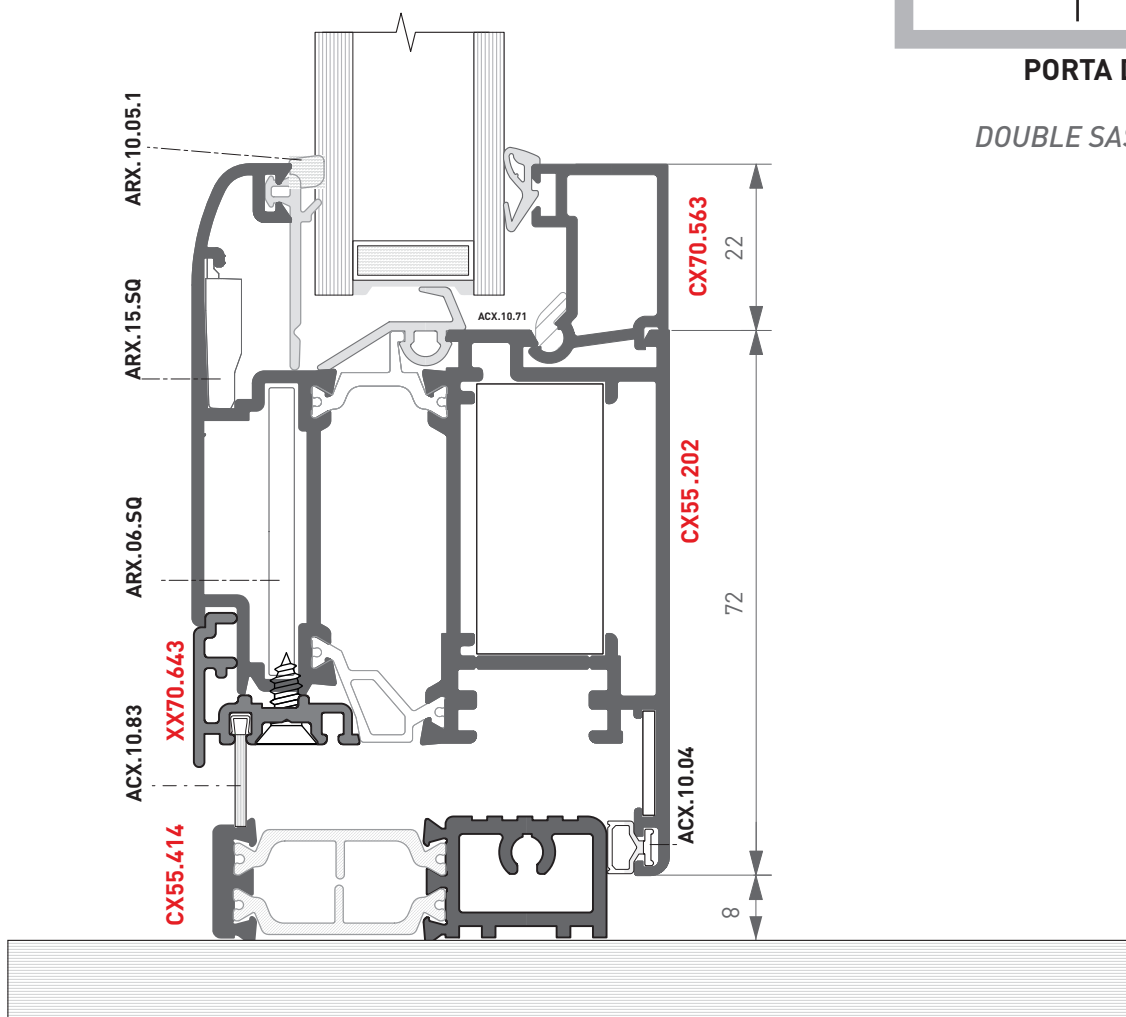

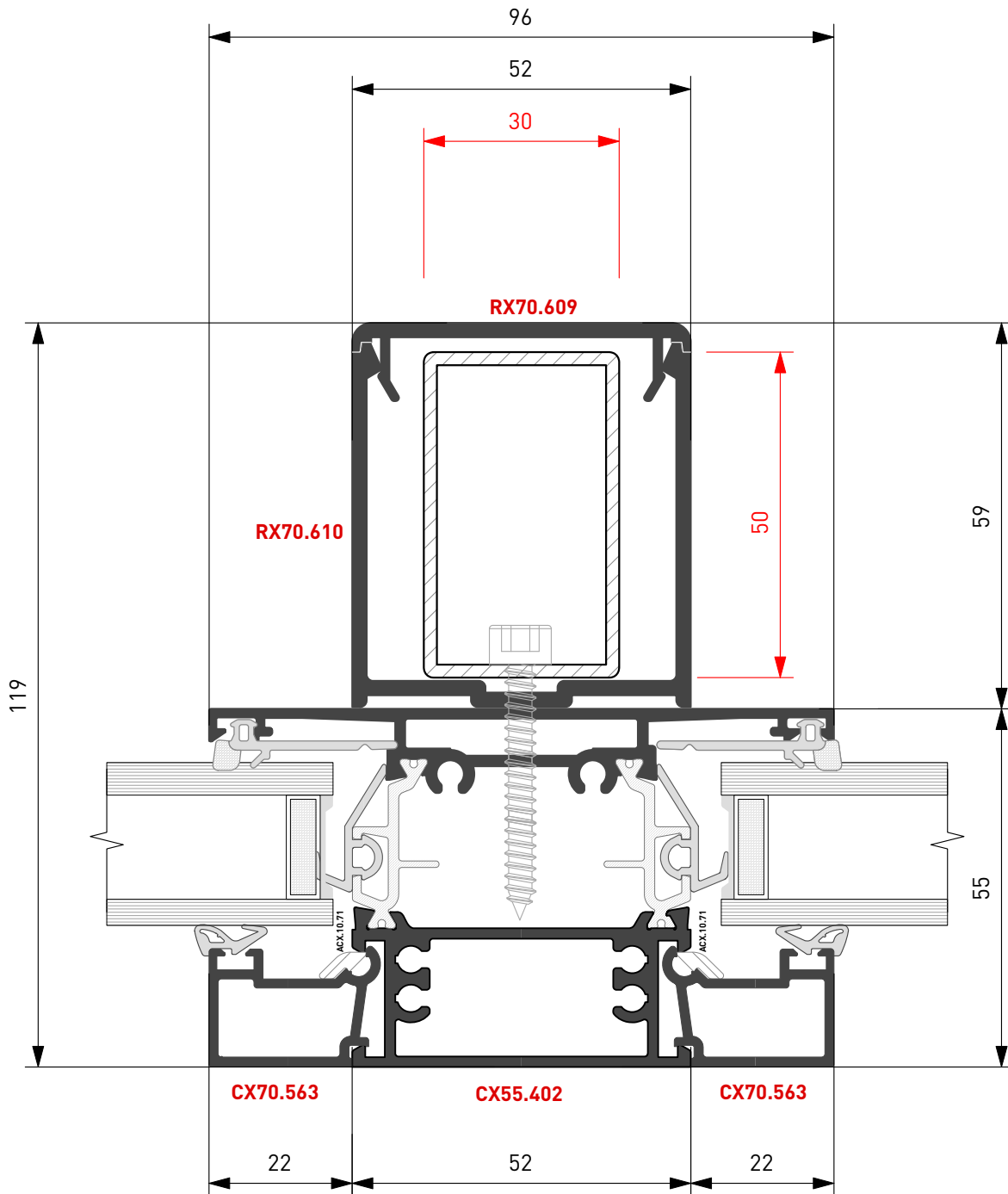

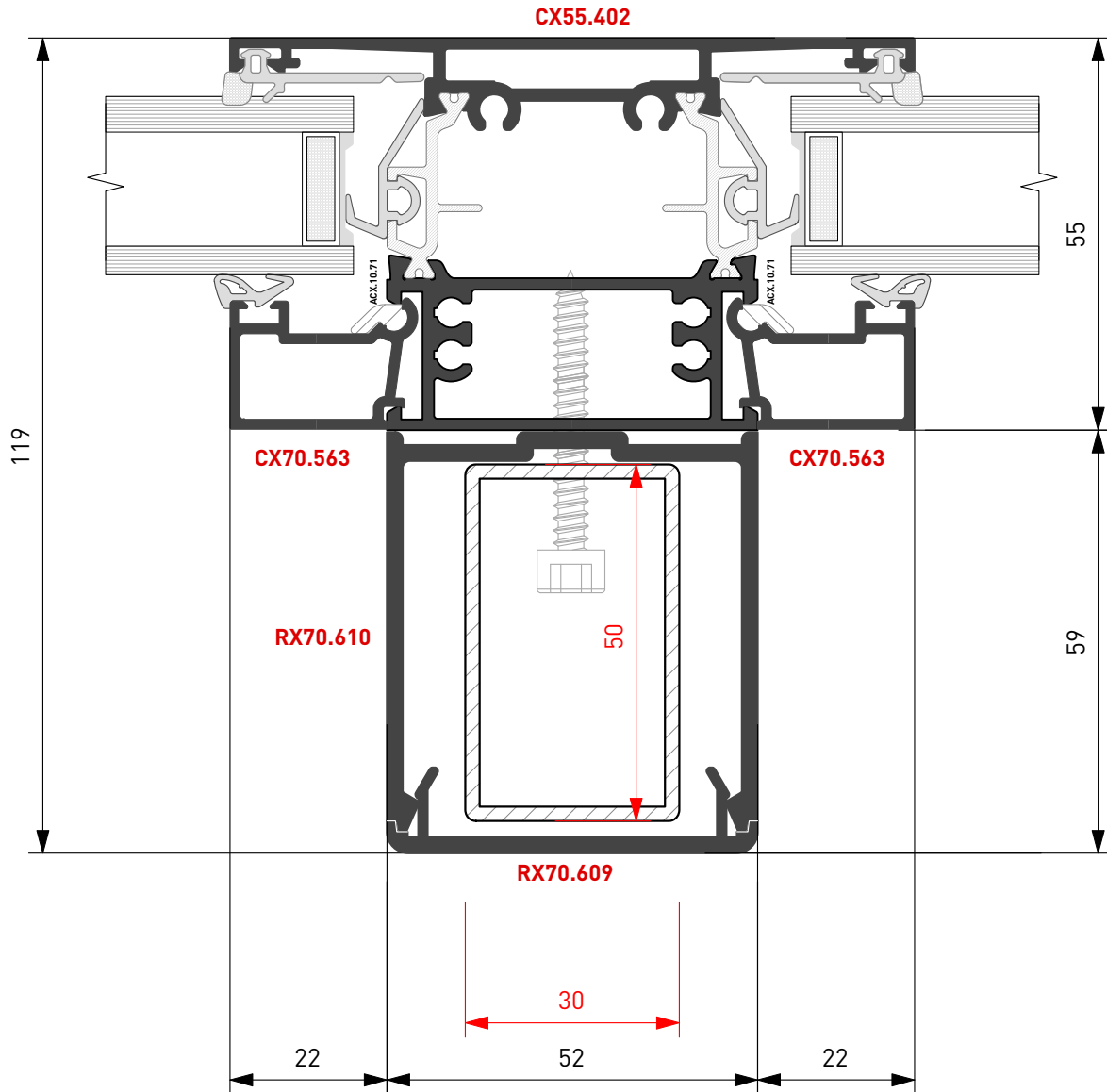

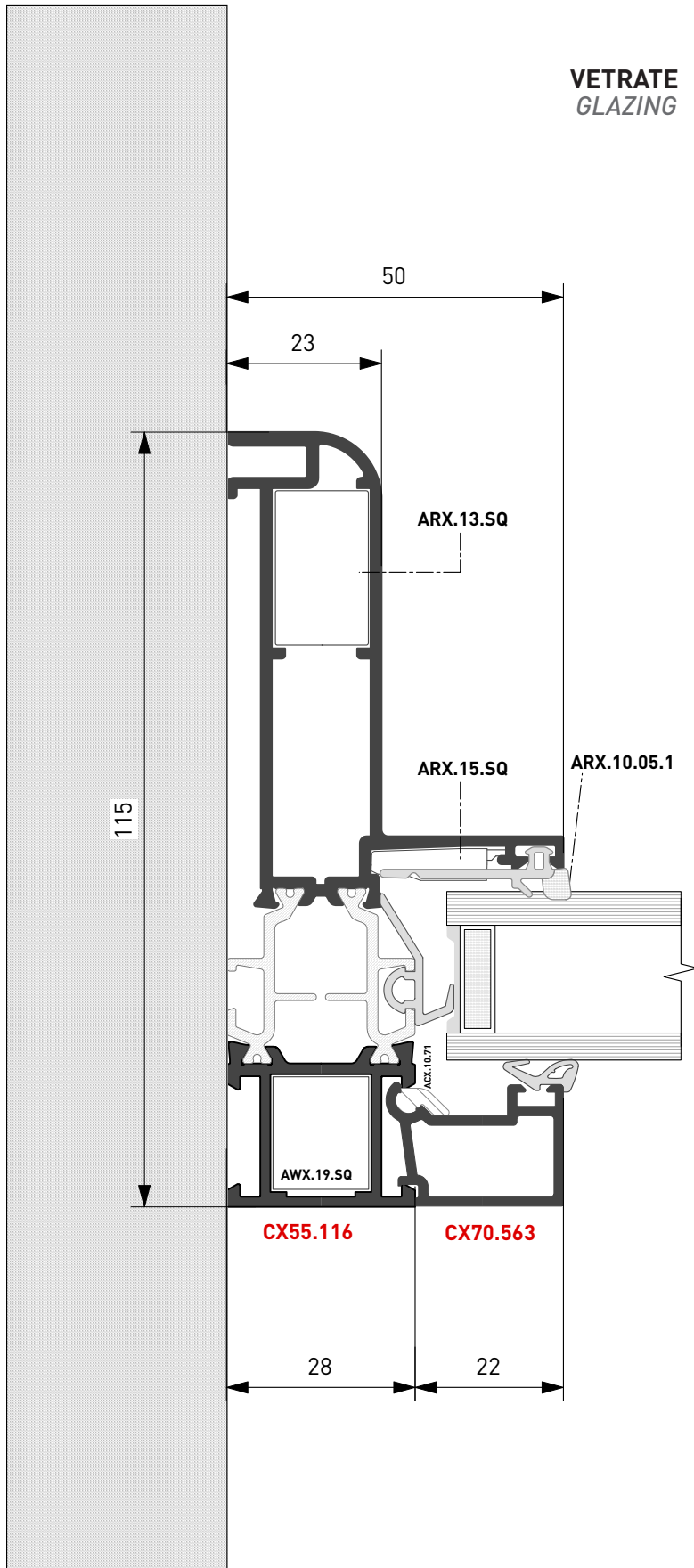

VETRATE
GLAZING

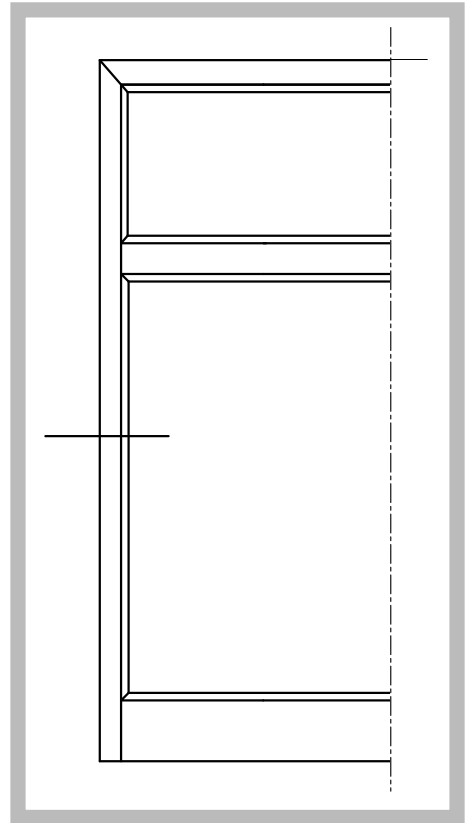



VETRATE
GLAZING

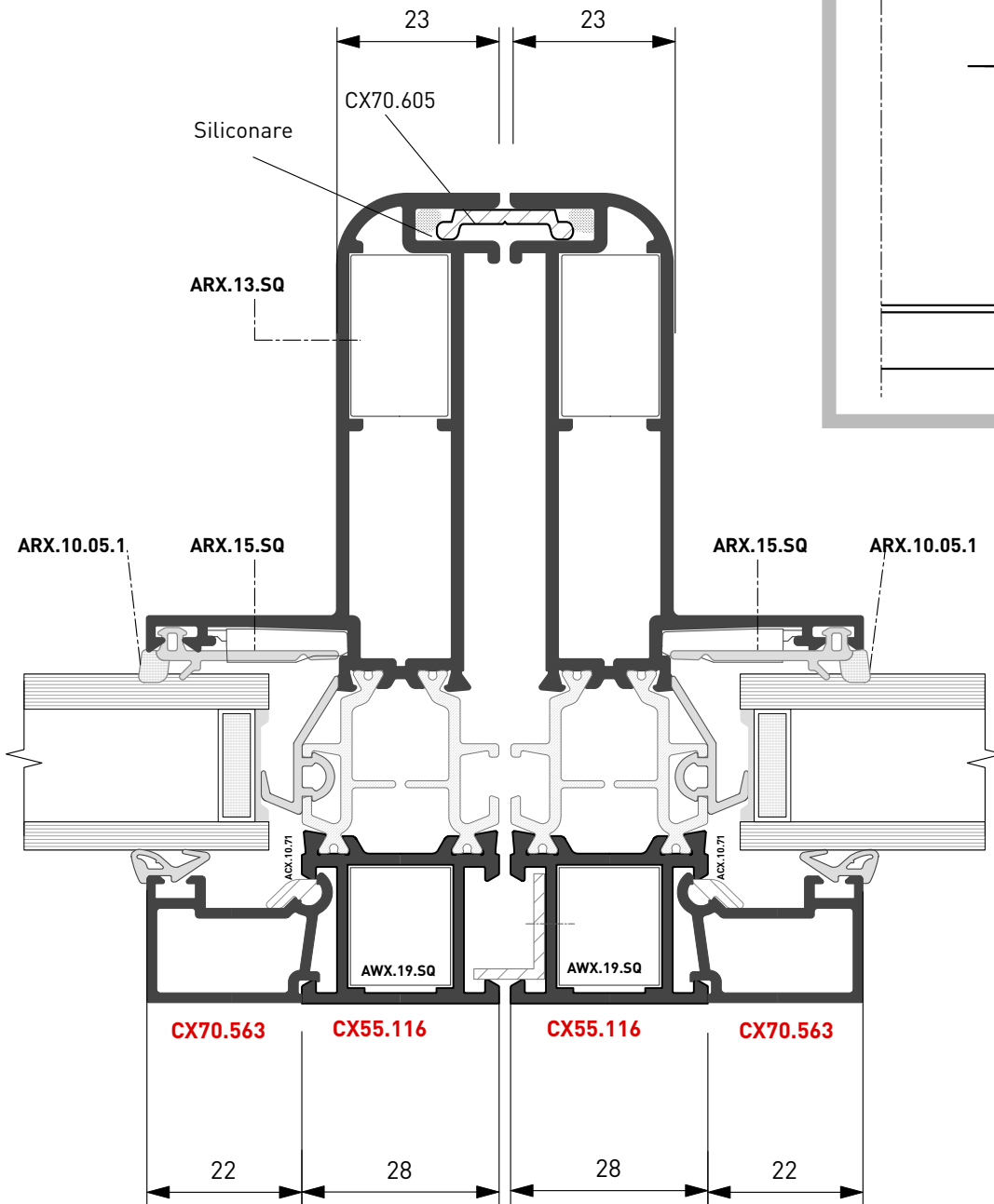
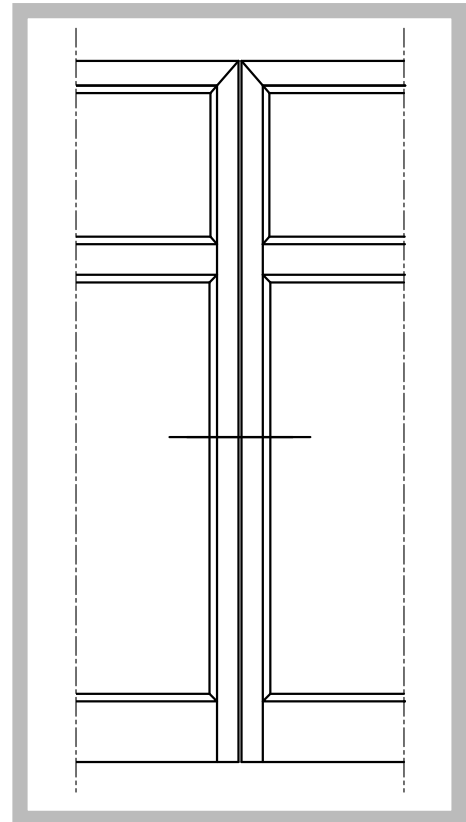



PORTA DI INGRESSO A 2 ANTE
Apertura esterna
DOUBLE SASHES ENTRANCE DOOR
External Opening

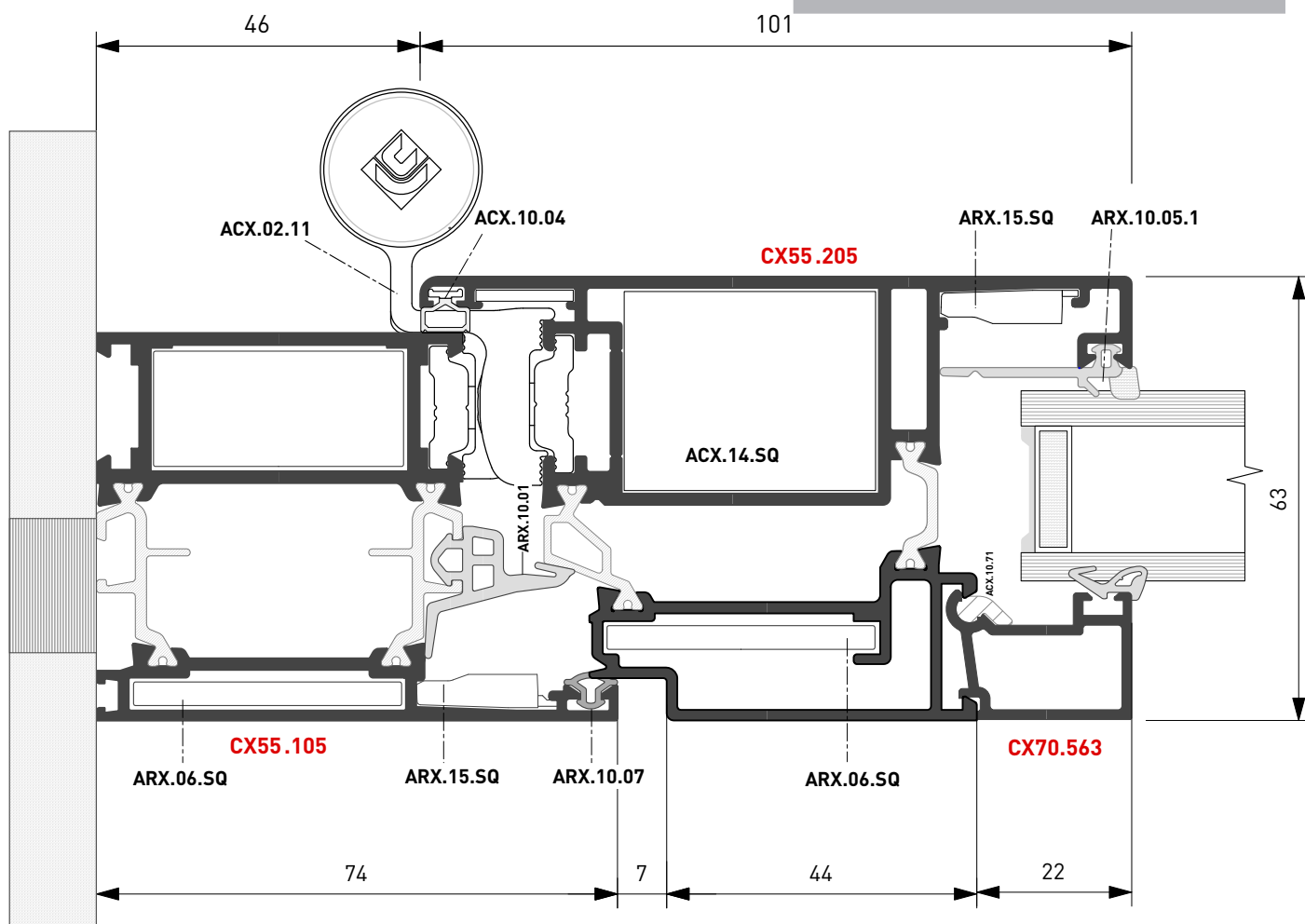
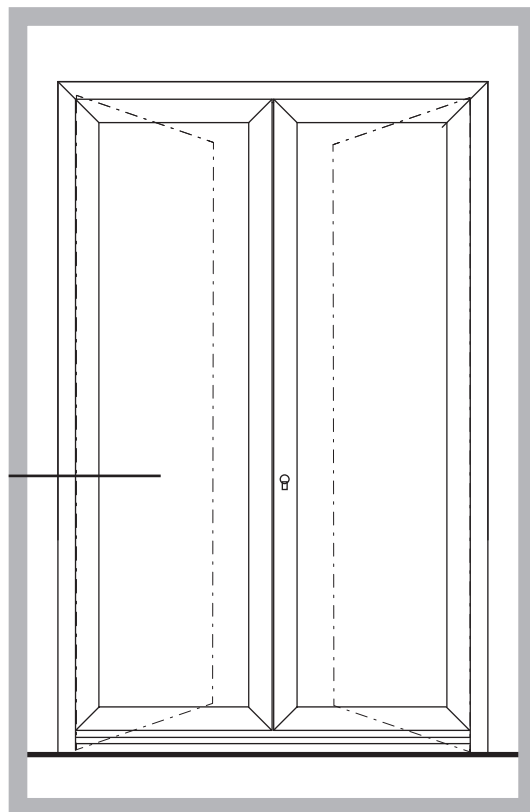



PORTA DI INGRESSO A 2 ANTE
Apertura esterna
DOUBLE SASHES ENTRANCE DOOR
External Opening

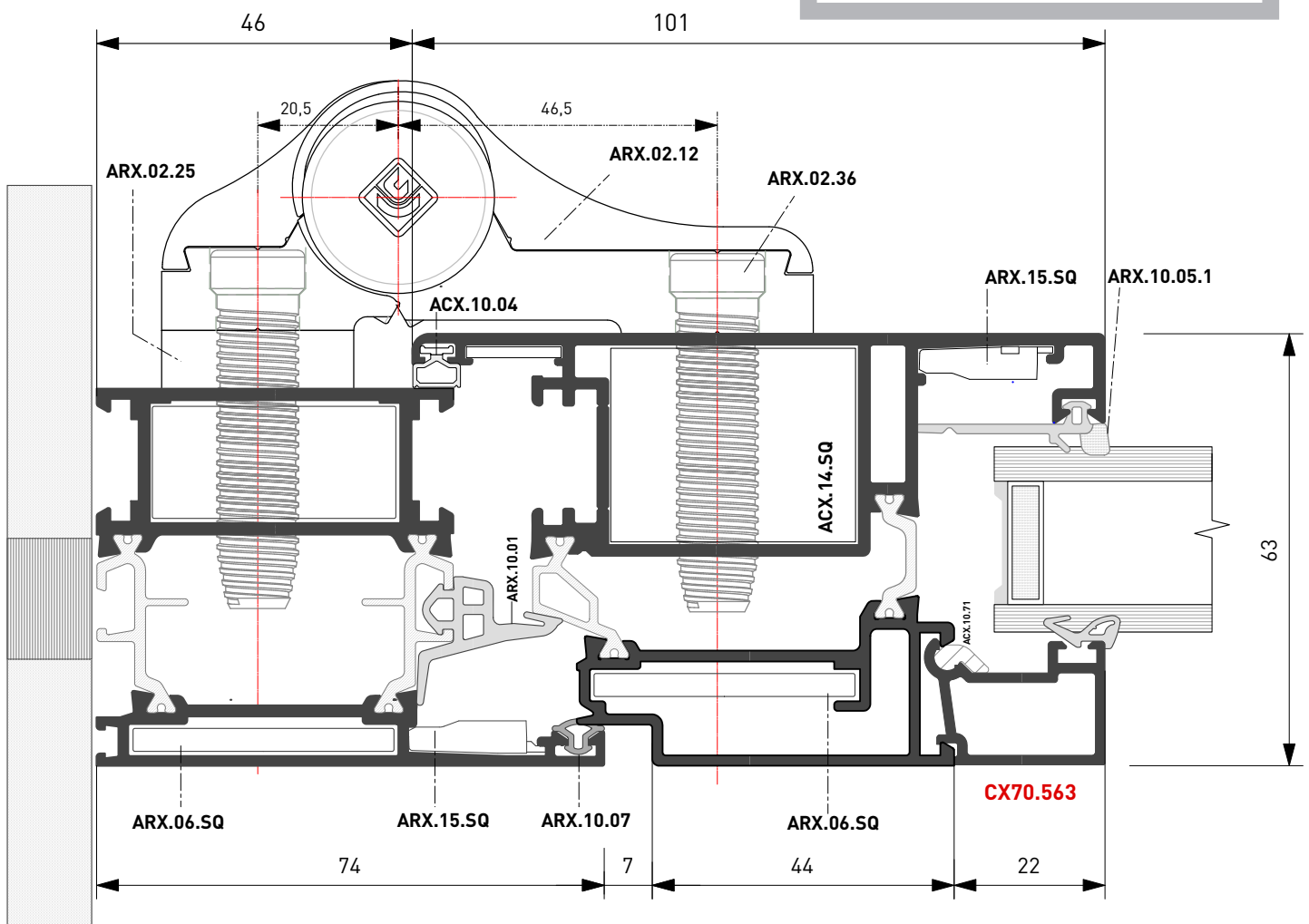
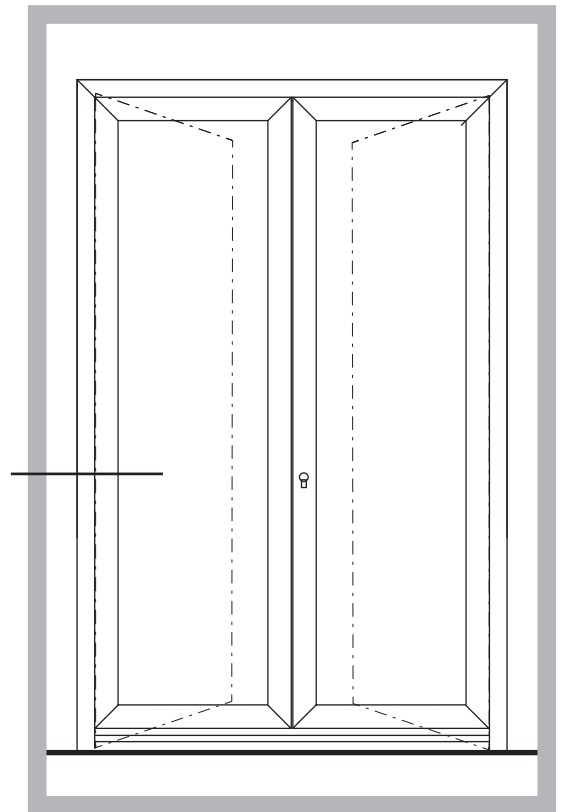



PORTA DI INGRESSO AD UNA ANTA
Apertura esterna
SINGLE SASH ENTRANCE DOOR
External Opening

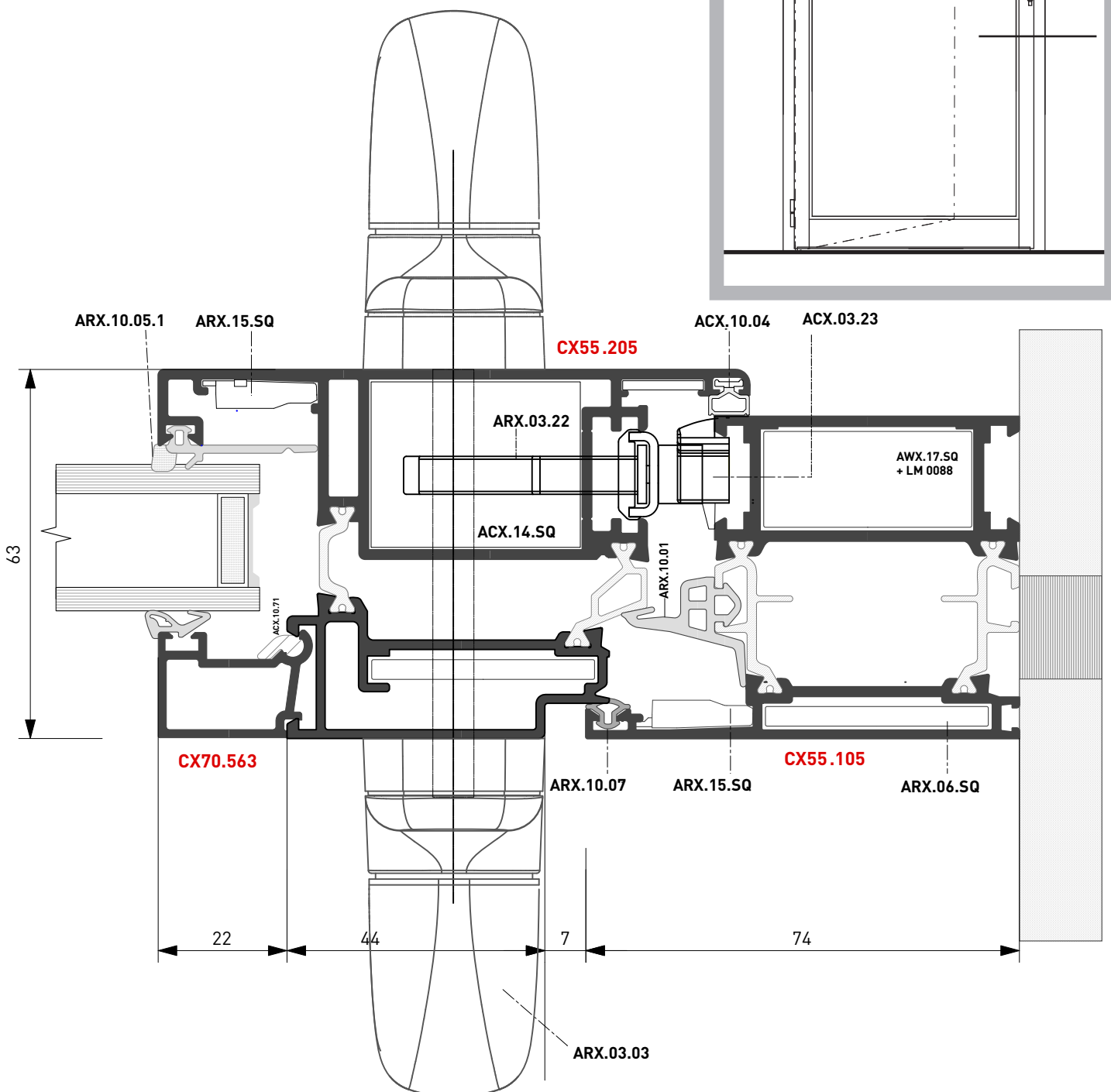
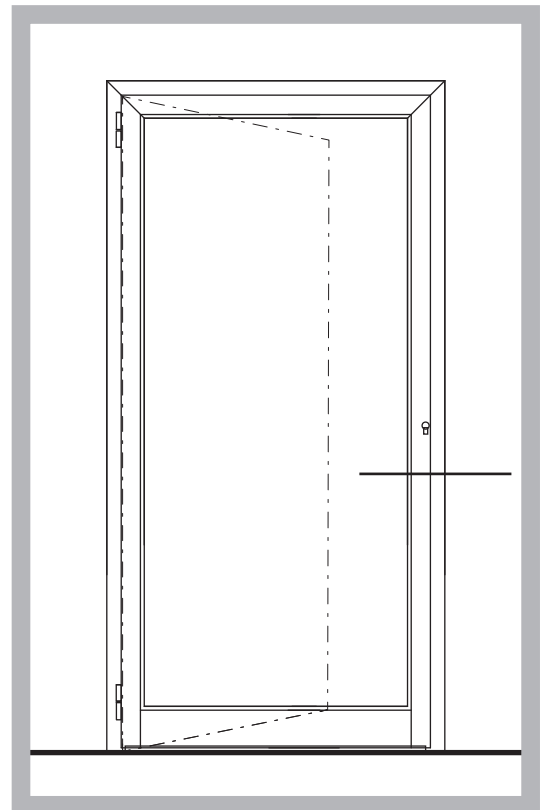

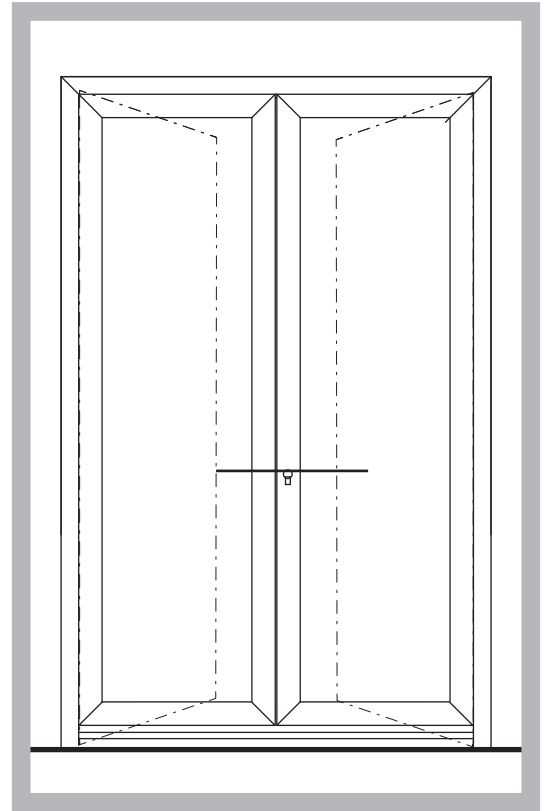
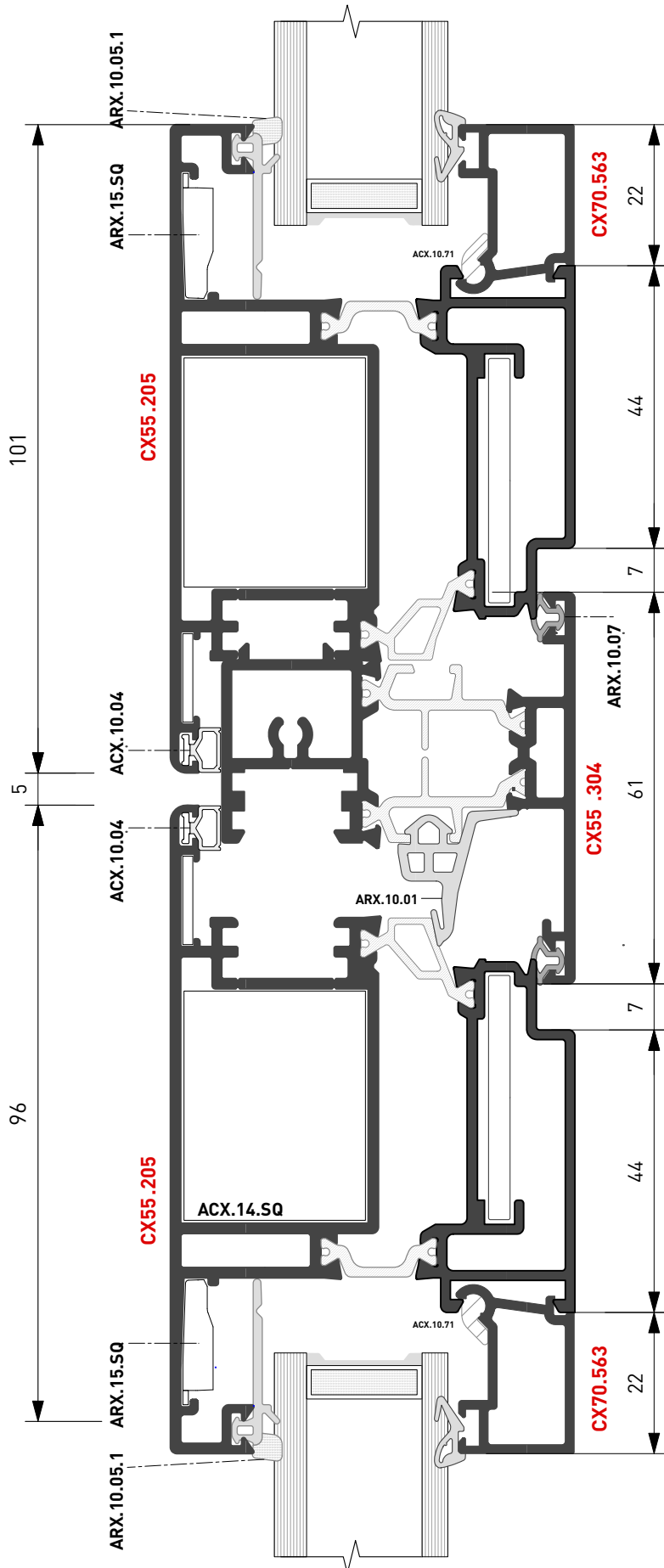

PORTA DI INGRESSO A 2 ANTE
Apertura esterna
DOUBLE SASHES ENTRANCE DOOR
External Opening

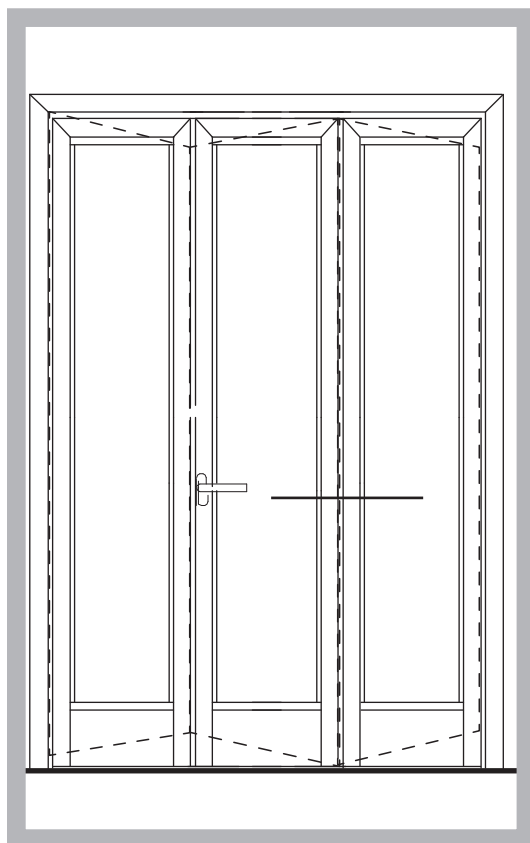
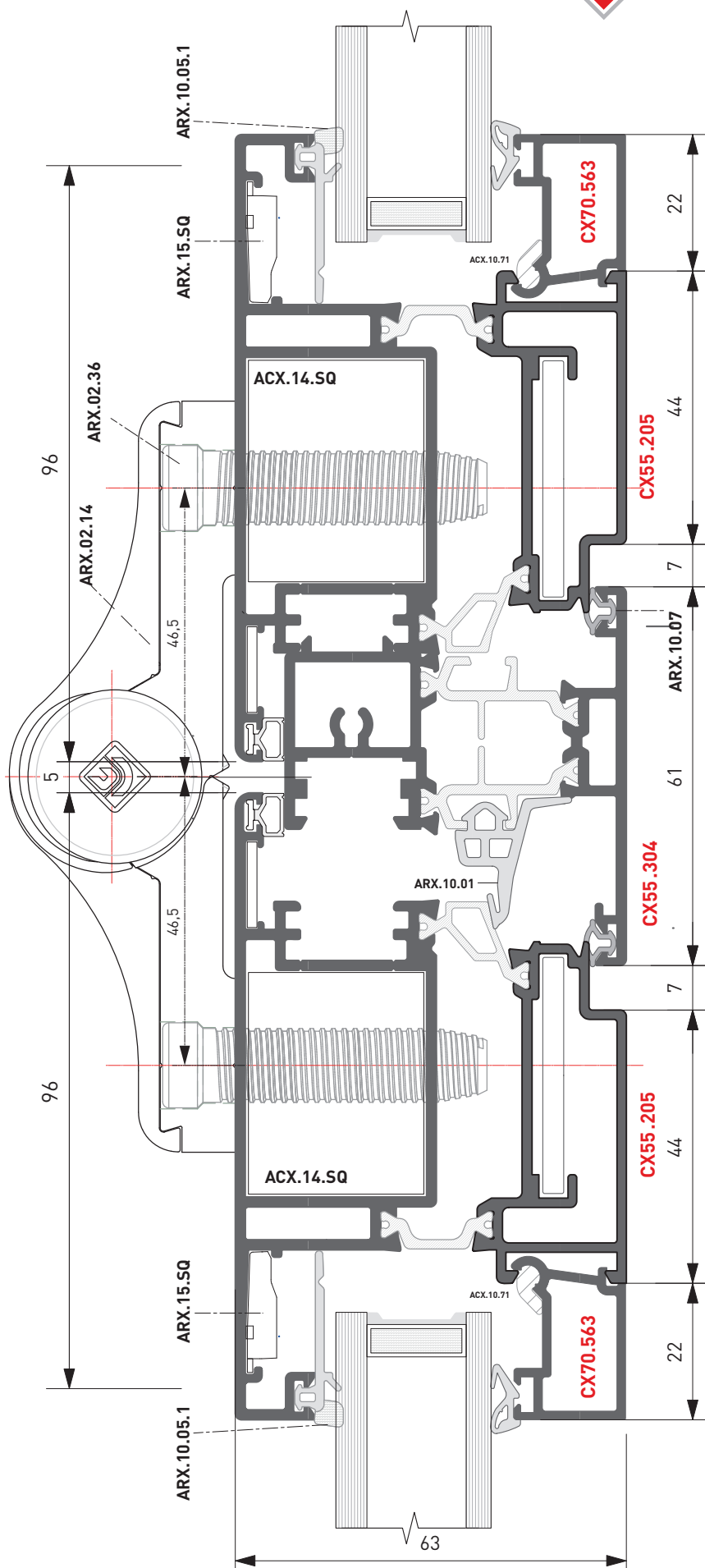

PORTA DI INGRESSO A 3 ANTE
Apertura esterna
3 SASHES ENTRANCE DOOR
External Opening



PORTA A 2 ANTE CON SOPRALUCE FISSO
Apertura esterna
DOUBLE SASH WINDOW + FIXED FANLIGHT TRANSOM
External Opening

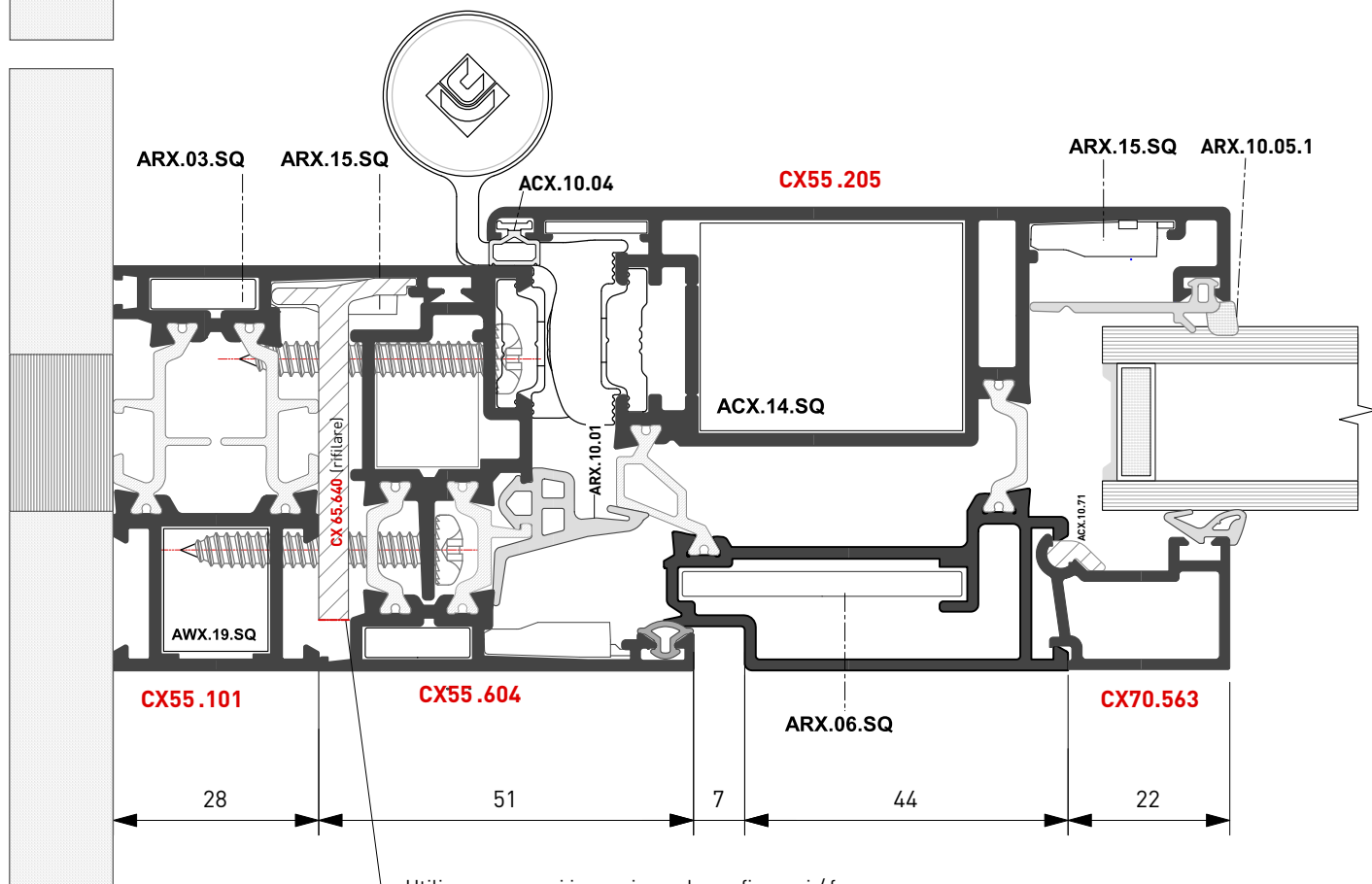
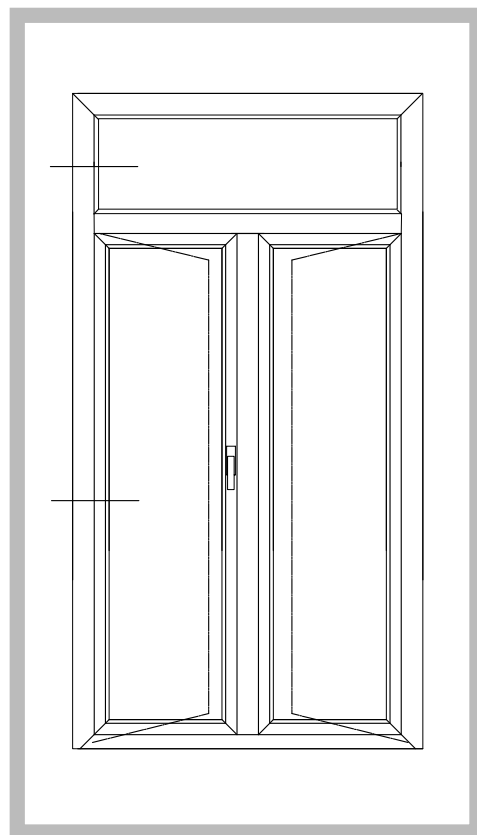
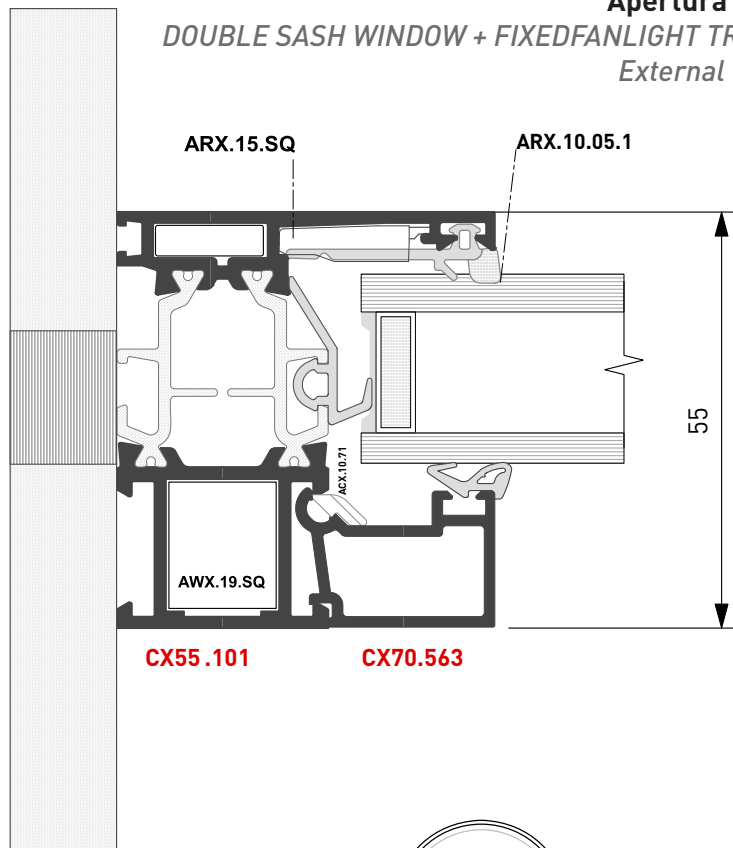

Utilizzare a pezzi in corrispondenza fissaggi / fresare.



PORTA DI INGRESSO A 2 ANTE
Apertura Interna
DOUBLE SASHES ENTRANCE DOOR
Internal Opening

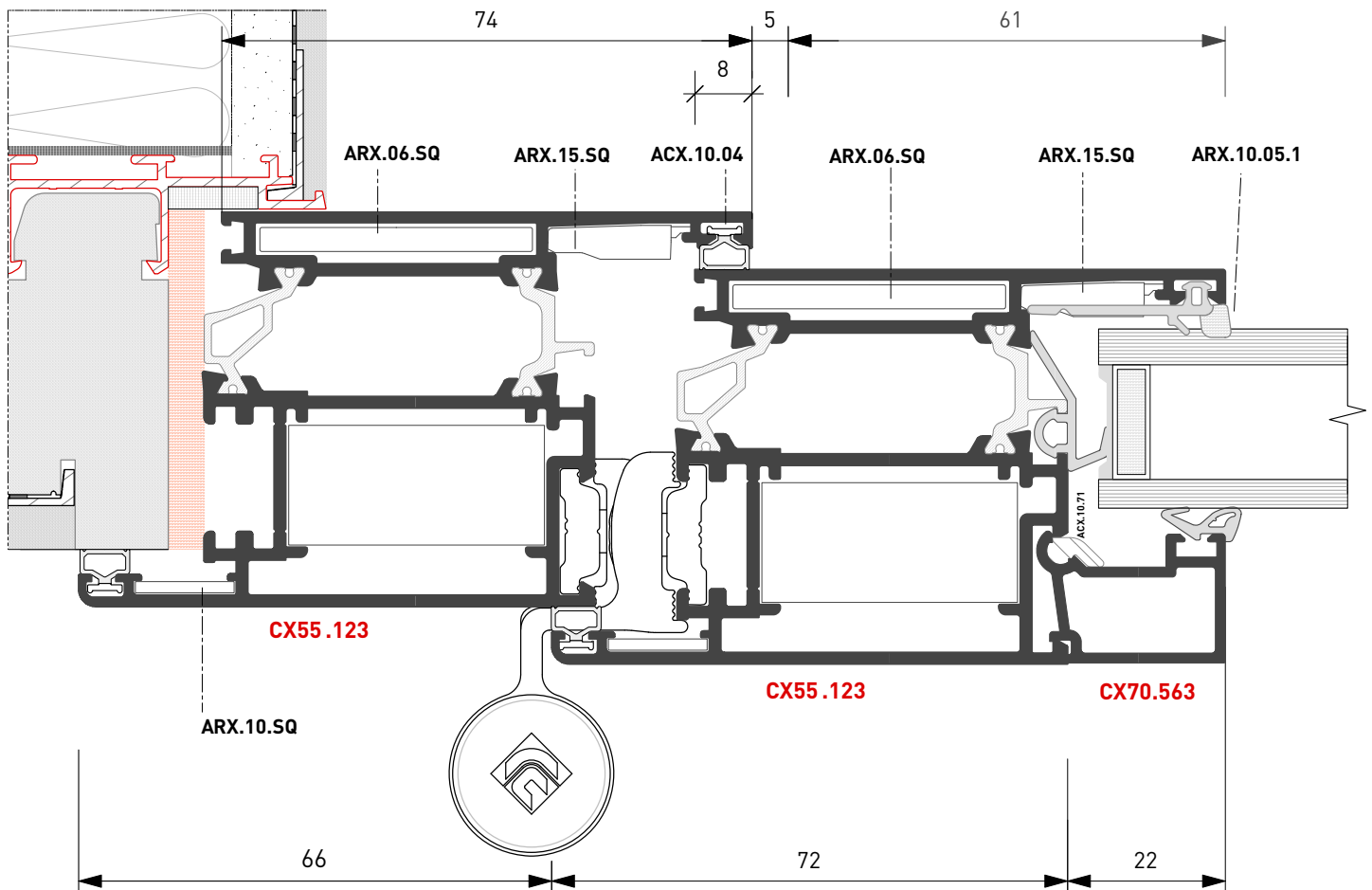
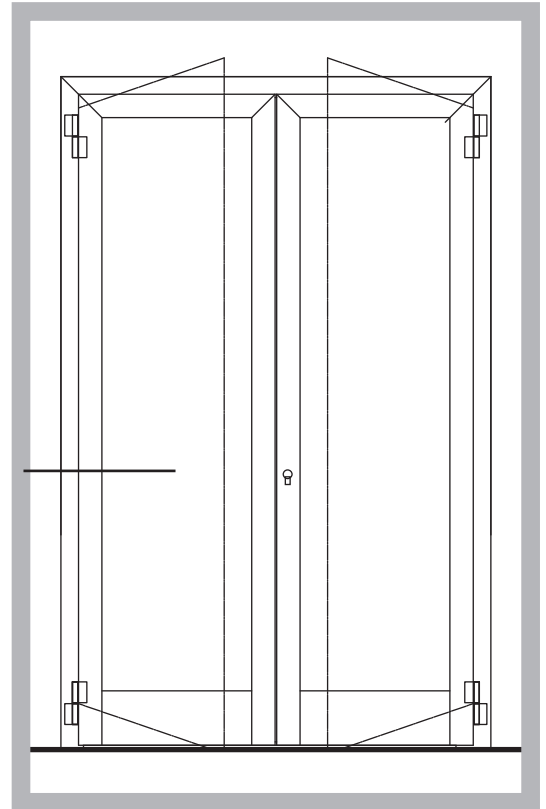

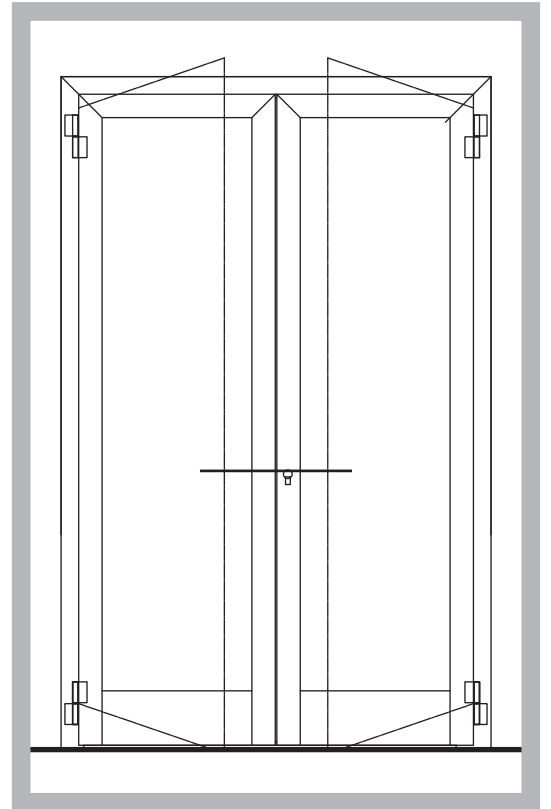
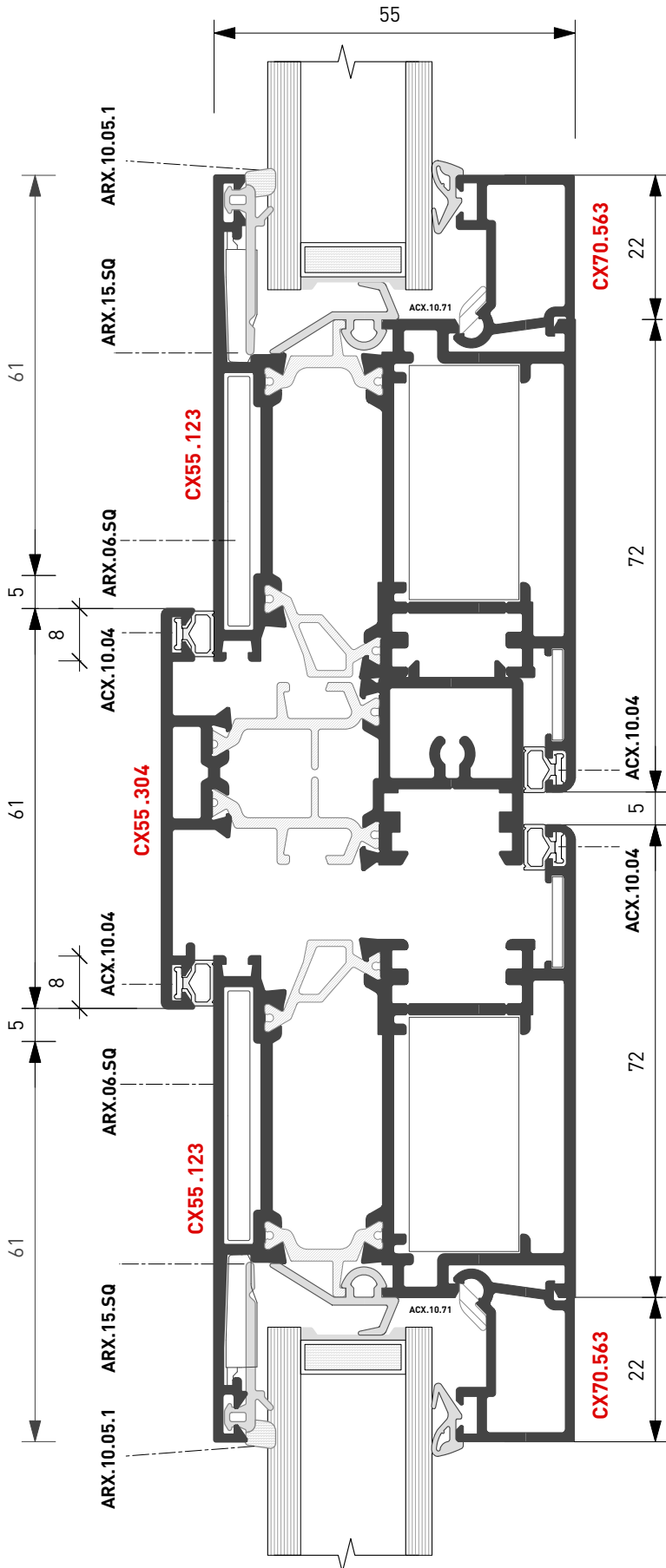

PORTA DI INGRESSO A 2 ANTE
Apertura Interna
DOUBLE SASHES ENTRANCE DOOR
Internal Opening



FINESTRA MONOBLOCCO
MONOBLOC WINDOW

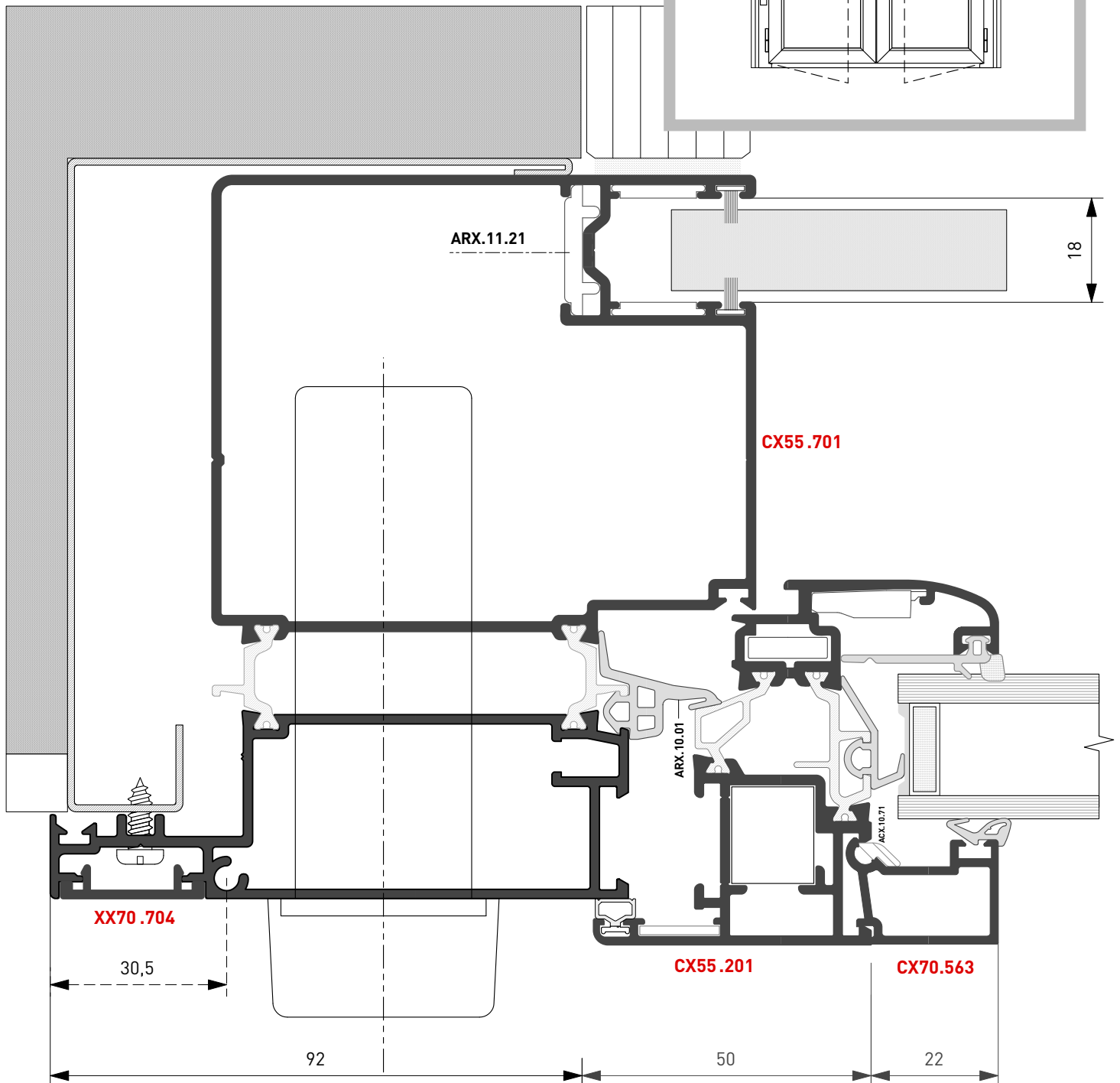
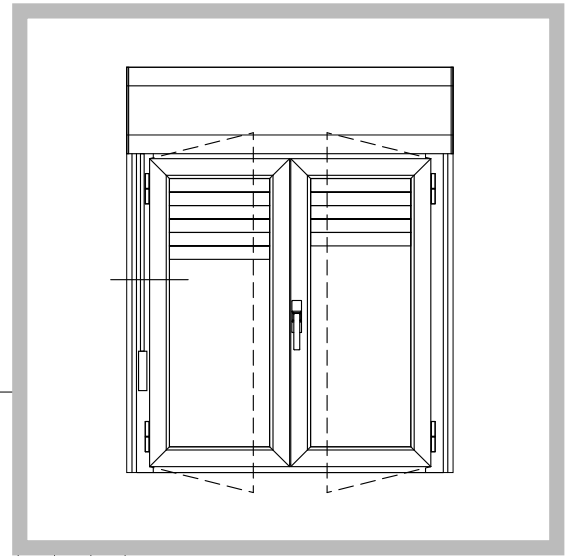



FINESTRA MONOBLOCCO
MONOBLOC WINDOW

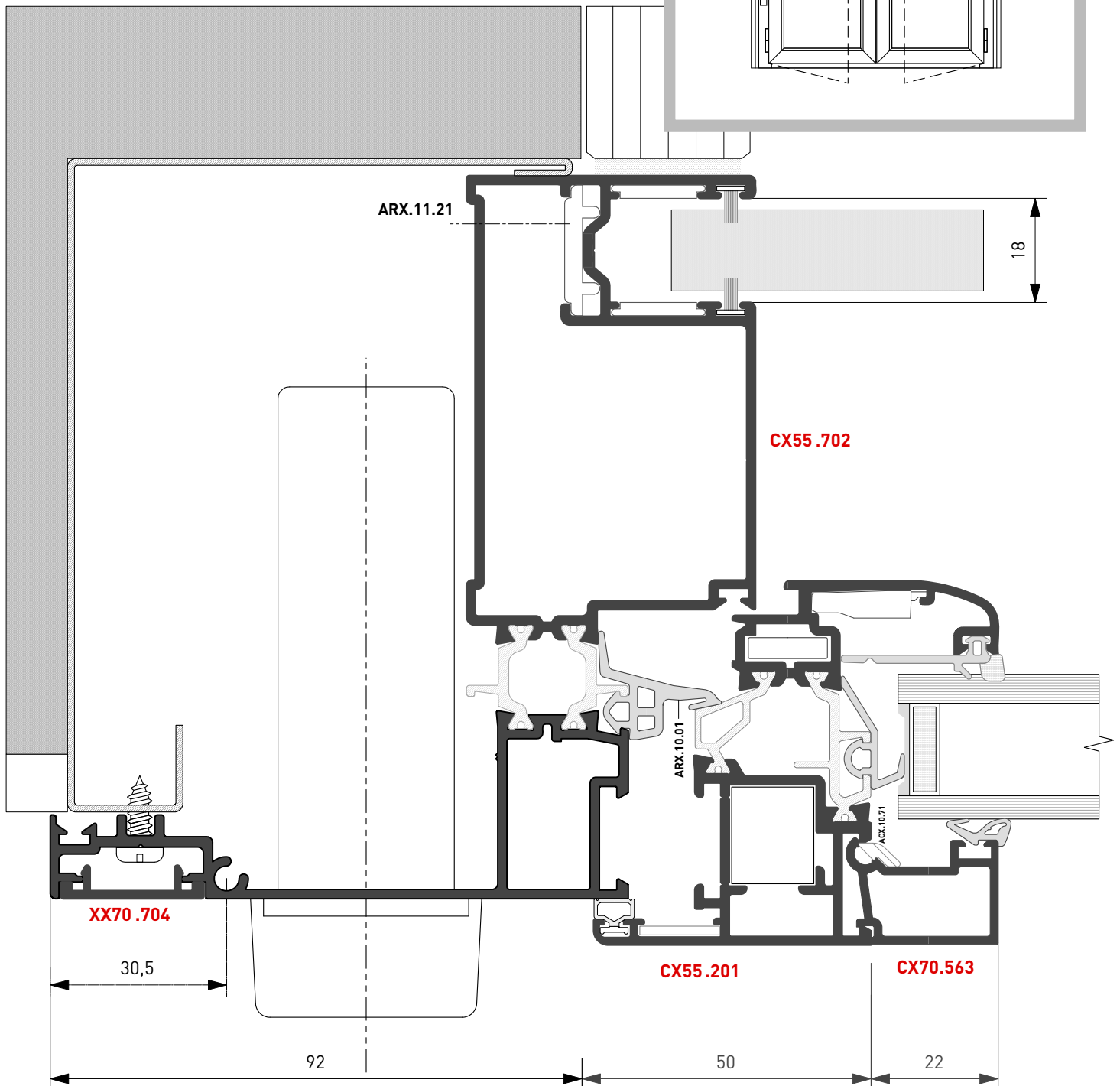
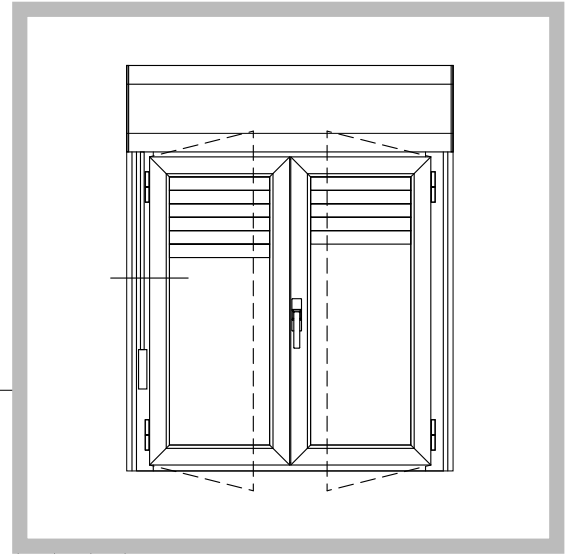



FINESTRA MONOBLOCCO
MONOBLOC WINDOW

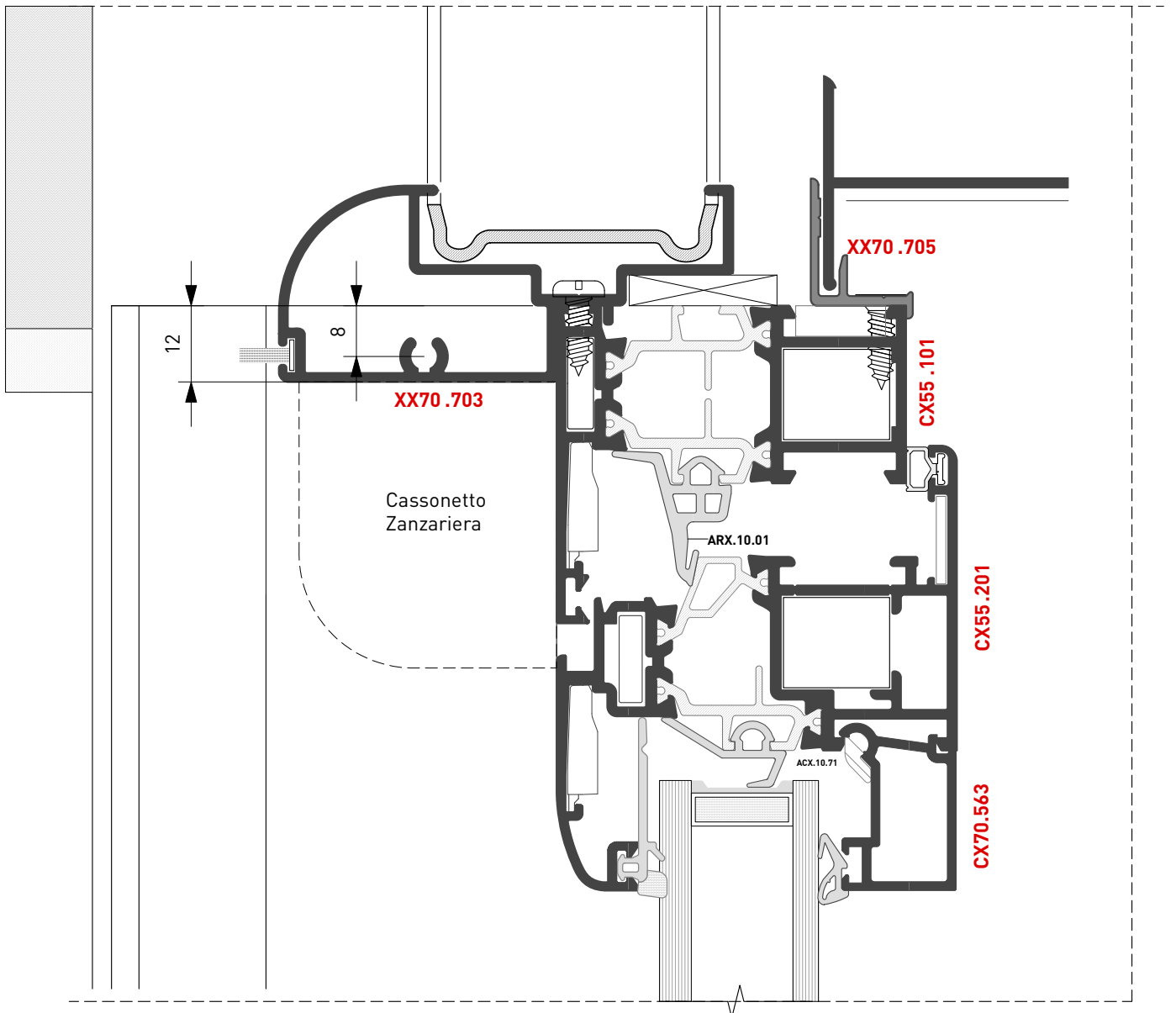
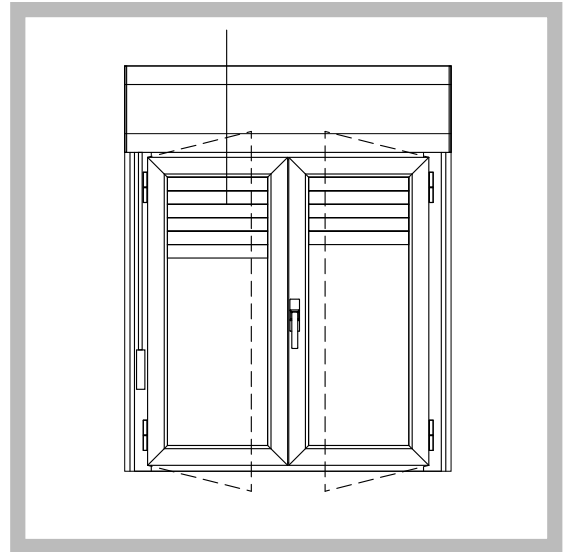



FINESTRA MONOBLOCCO
MONOBLOC WINDOW

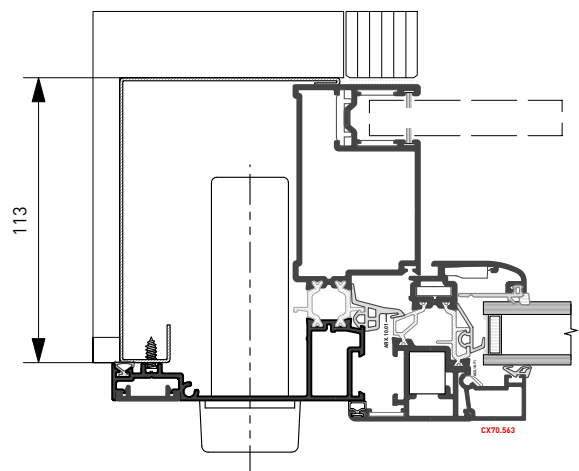
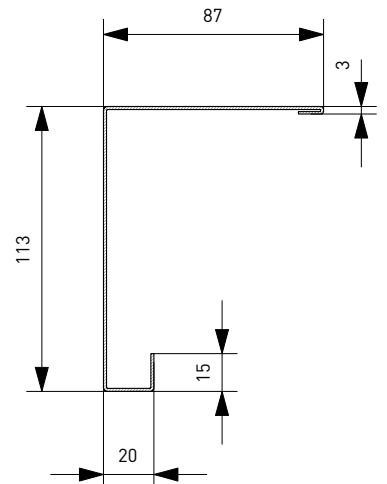
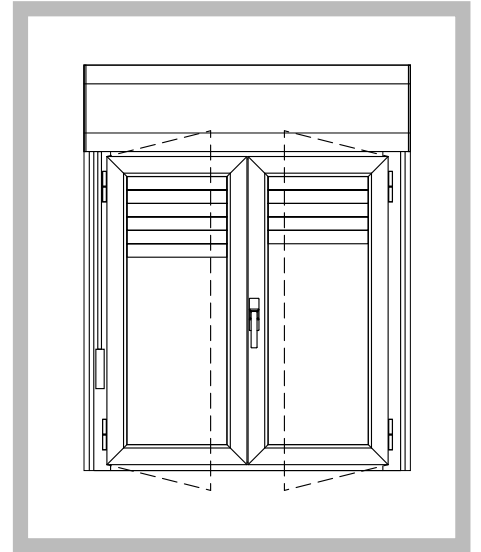
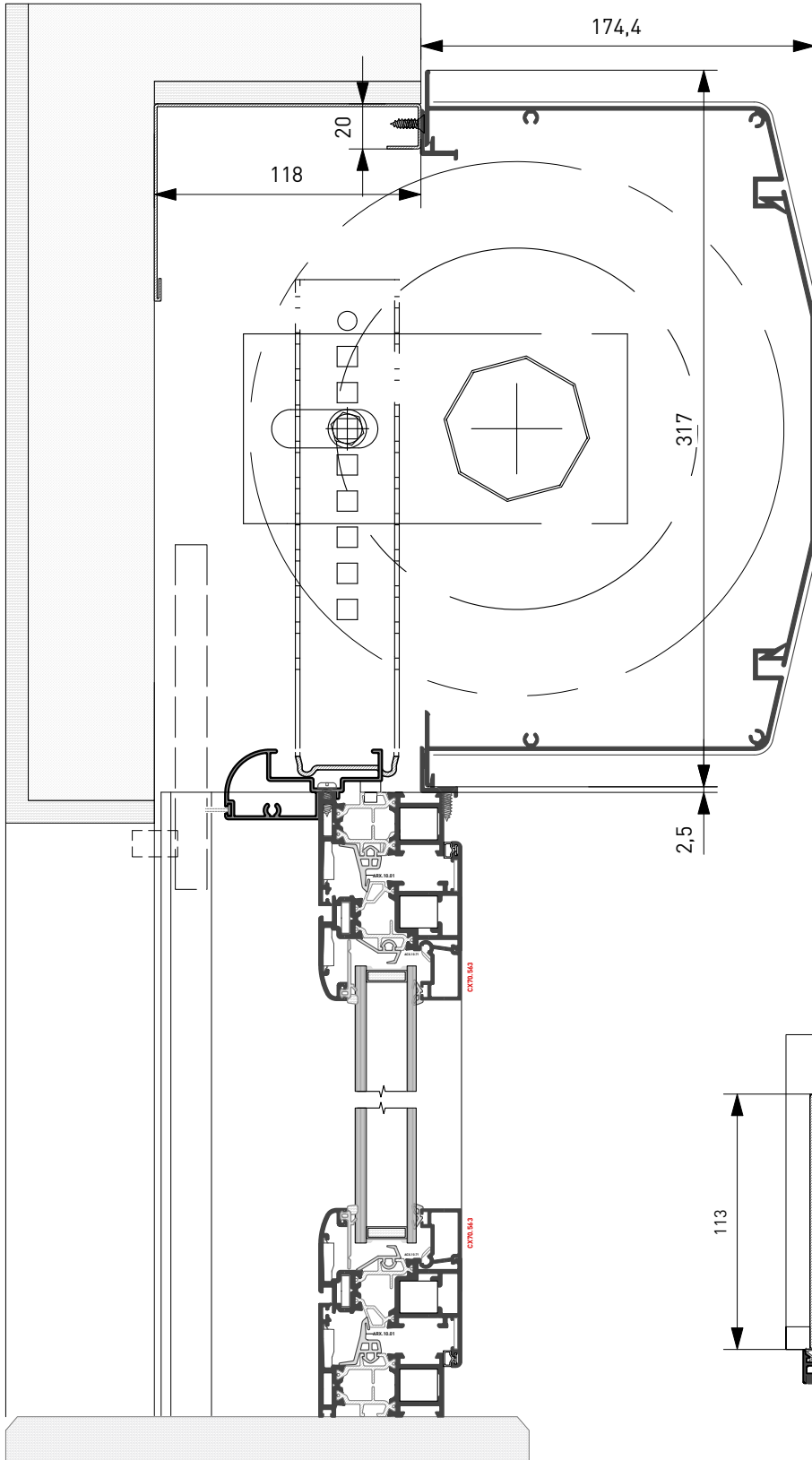



FINESTRA A 2 ANTE
DOUBLE SASH WINDOW

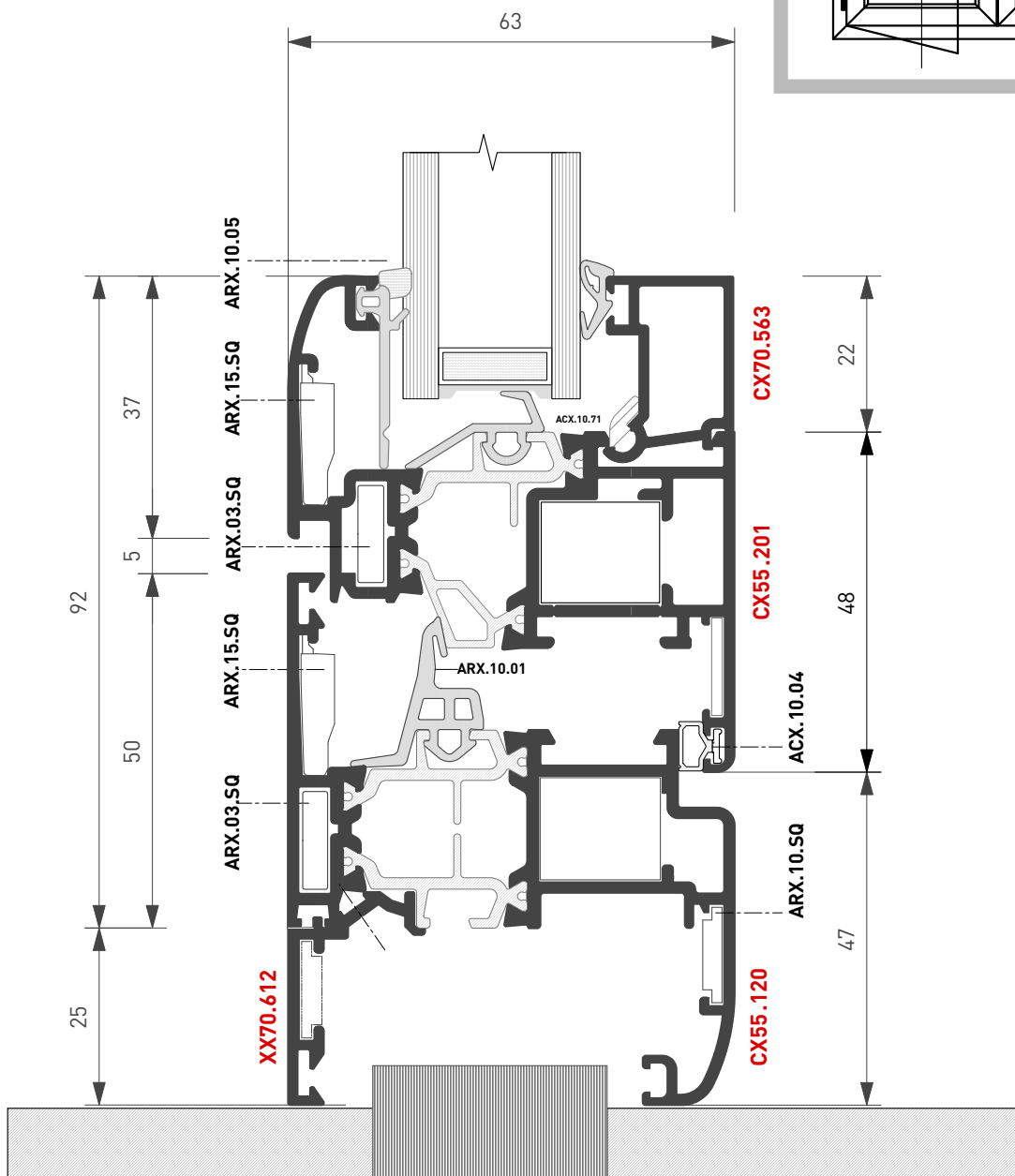
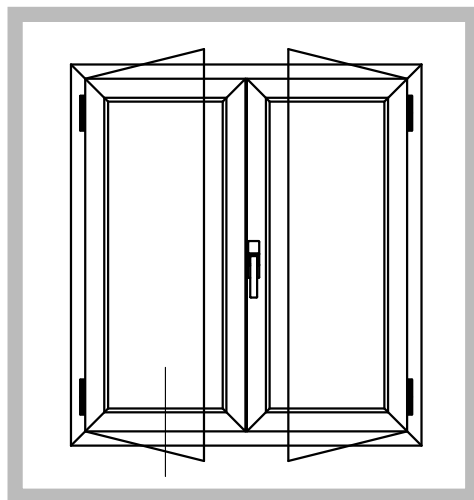



FINESTRA A 2 ANTE
con scuretto
DOUBLE SASH WINDOW
w/ shutter

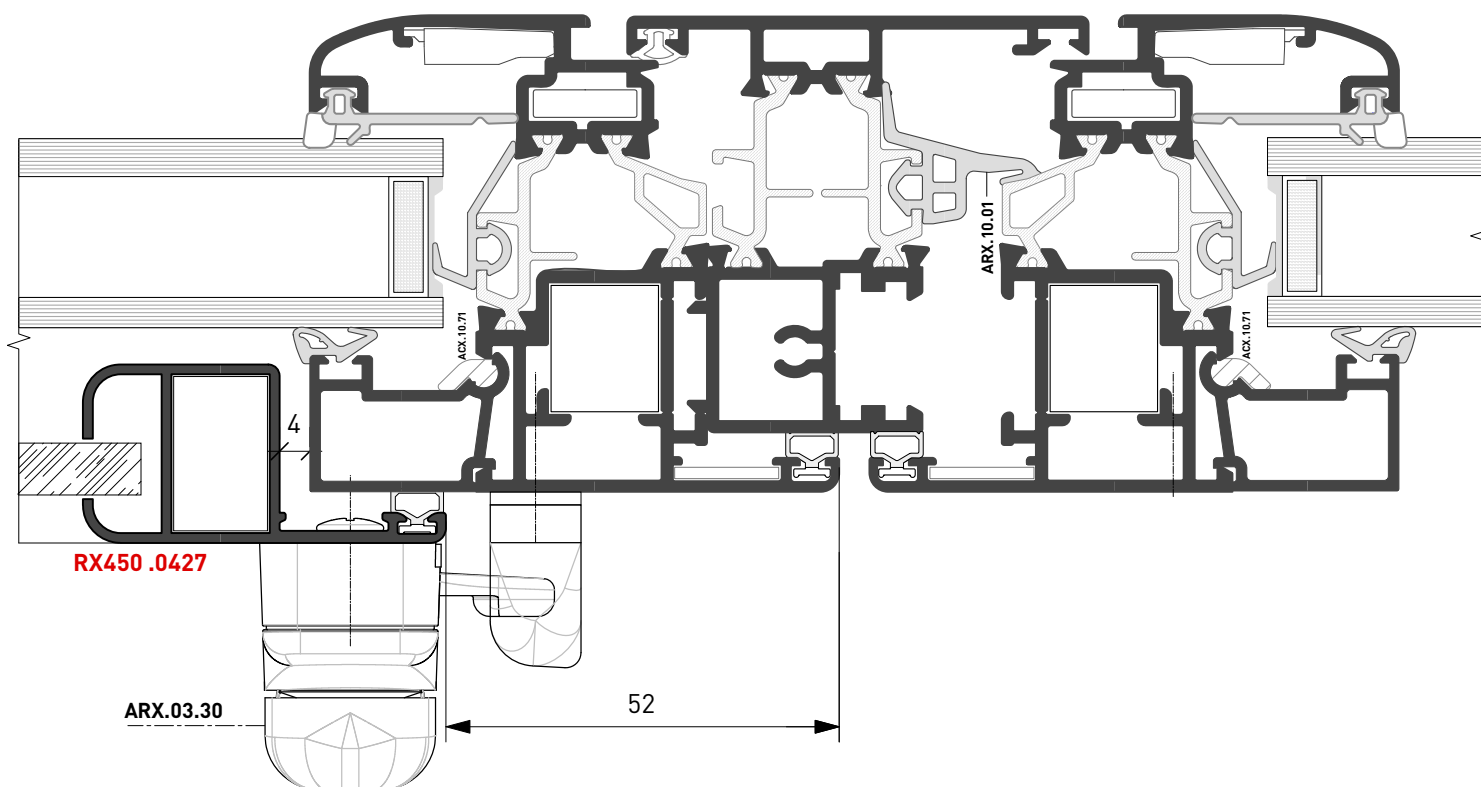
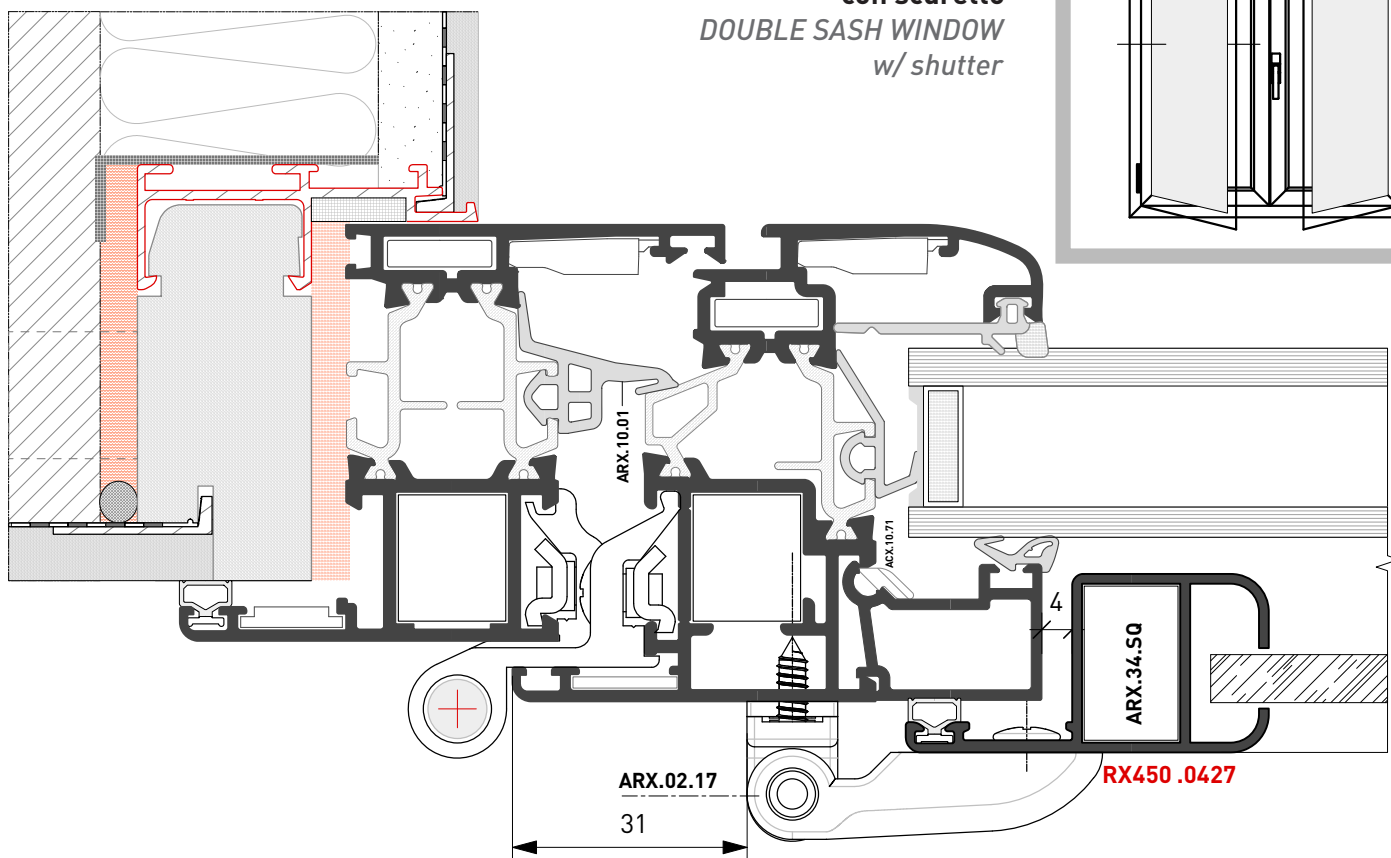
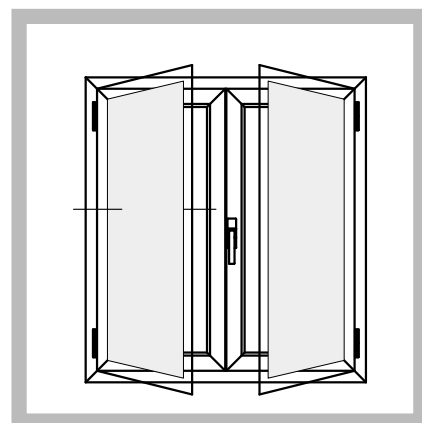



FINESTRA A 2 ANTE
Apertura esterna
DOUBLE SASH WINDOW
External Opening

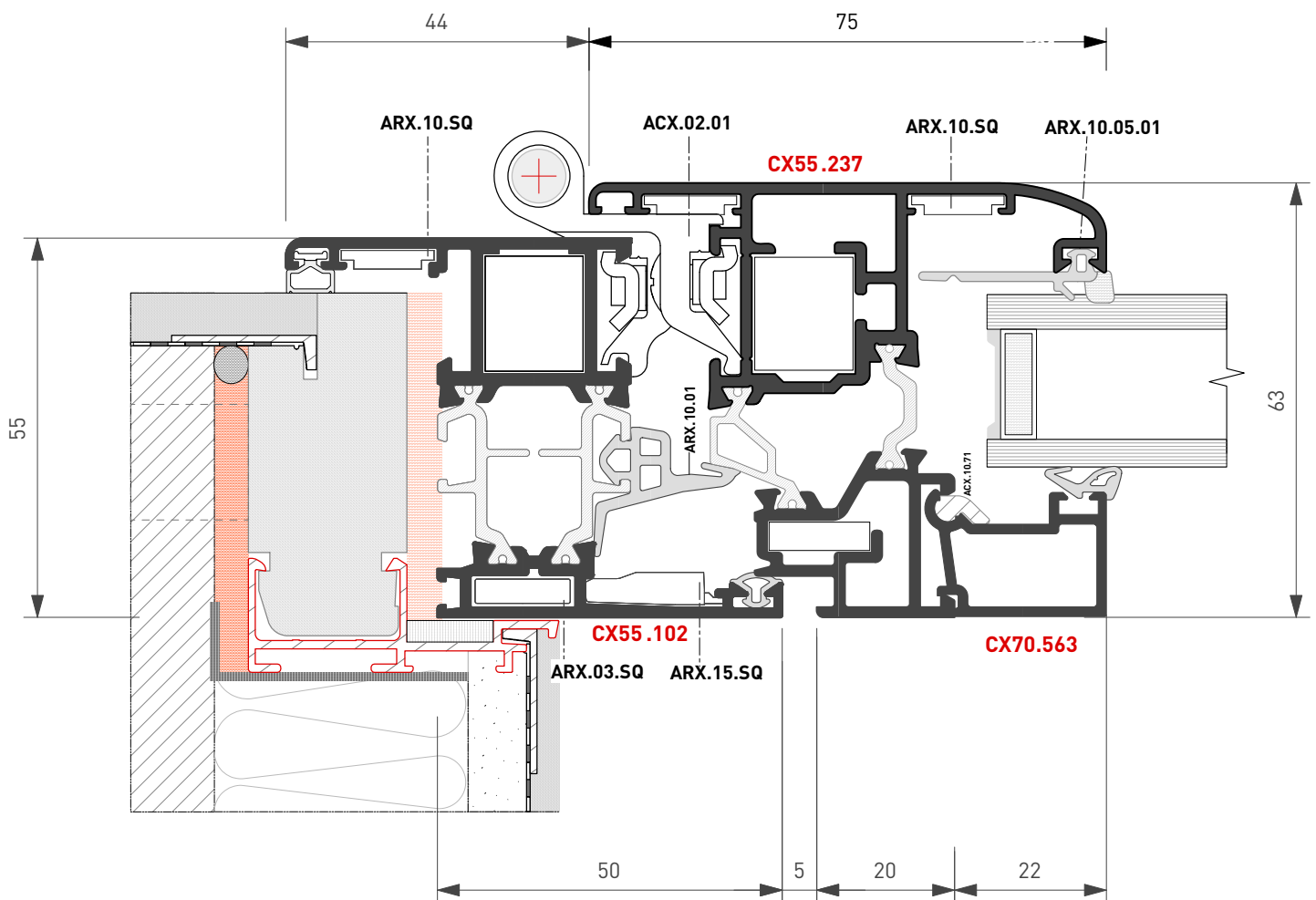
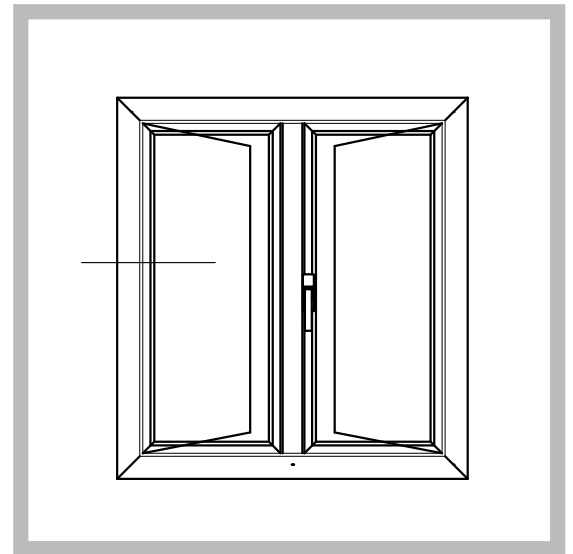



FINESTRA A 2 ANTE
Apertura esterna
DOUBLE SASH WINDOW
External Opening

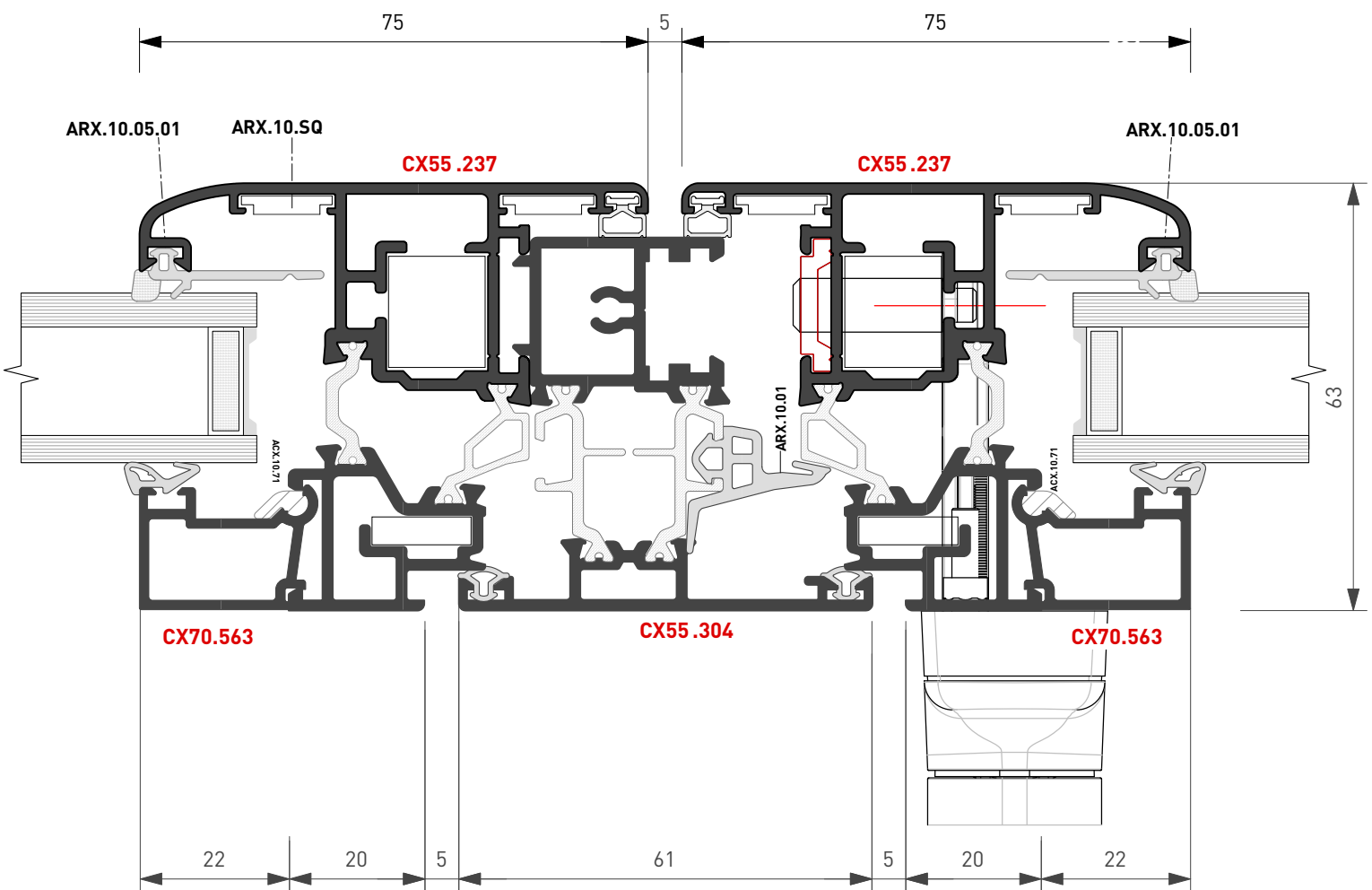
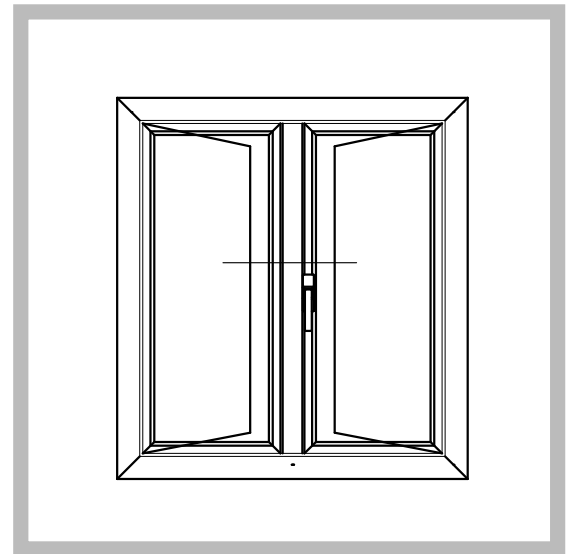

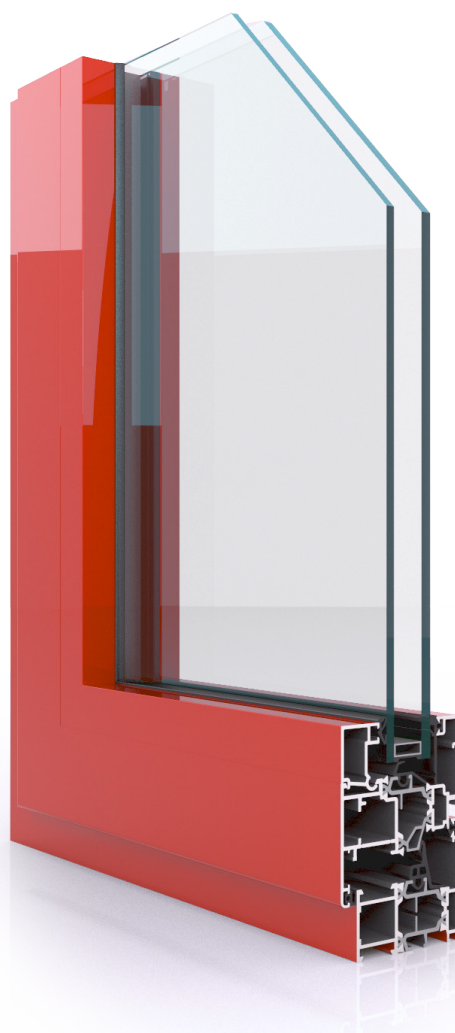

Tipologie
Types

Gruppo **E**

Tipologie  *Main Sections*



■ Finestra 1 Anta
1 Sash Window

Accessori & Guarnizioni | Accessories & Gaskets

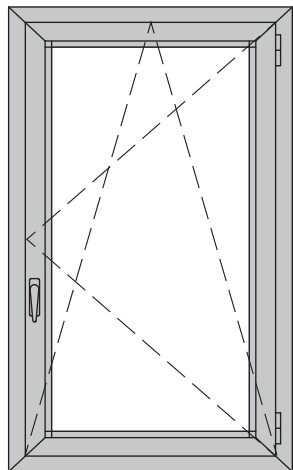

Art. Code	Descrizione Description	Qt.
AWX.19.SQ	Squadretta Telaio /Anta Frame/door corner connection	8
ARX.03.SQ	Squad. Cianfrinare EXT. External riveting corner joint	8
ARX.15.SQ	Squad. Allin. Telaio/Anta Frame/door aligning corner joint	8
ARX.10.SQ	Squad. Allin. Anta INT. Internal door aligning corner joint	4
ACX.02.01	Cerniera 2 Ali 2-leafed hinge	2
ARX.03.06	Cremonese Pressofusa Die-cast Cremonese bolt	1
ACX.03.17	Innesti Cremonese Cremonese bolt connections	2
ACX.03.18	Terminale Astina Bbar Terminal	2
ACX.03.13	Ferrogliera Striker plate	2
ARX.05.01	Copriaccola Scarico Acqua Water drainage slot cover	2
ARX.06.01	Espansore Expander	*
ARX.10.01	Guarnizione Precamera Prechamber Gasket	2L, 2H
ACX.10.04	Guarnizione Battuta Rabbet window gasket	2L, 2H
ARX.10.05.1	Guarnizione Vetro EXT External glass window gasket	2L, 2H
*	Guarnizione Vetro INT Internal glass window gasket	2L, 2H
ARX.10.02	Angolo Guarnizione Precamera Pre-chamber corner connection window gasket	4

* Secondo Dimensioni | Depending on size

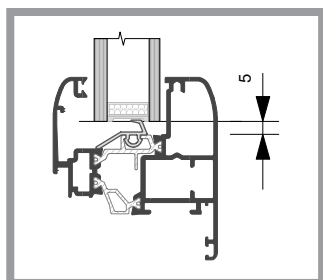
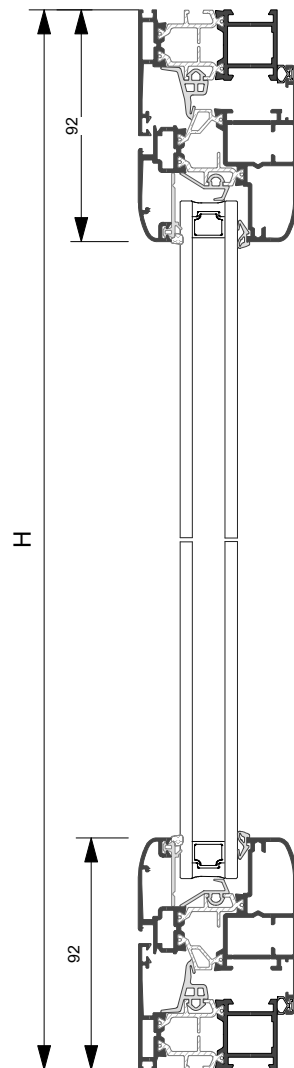

DISTINTA Taglio Vetri		
Qt.	H	L
1	H-150	L-150
Spazio/Gap 5 mm.		

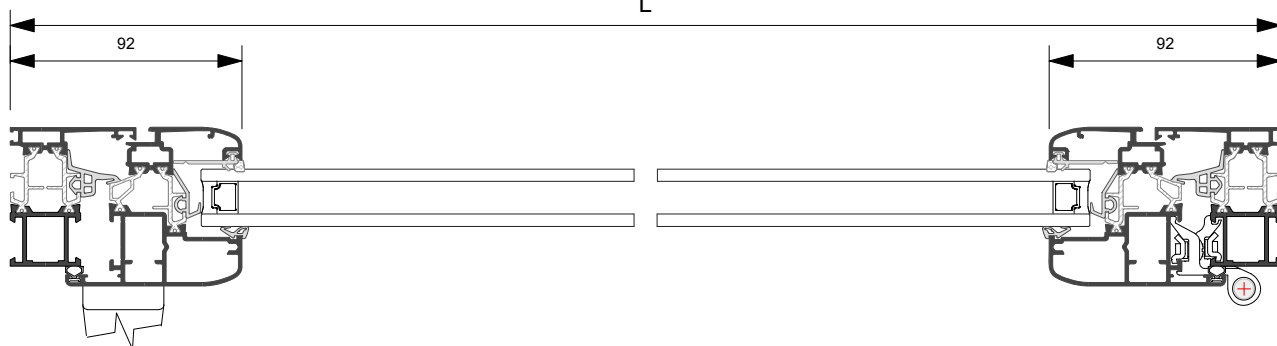

Profilo Profile	Taglio CUT	Qt.	Profilo Profile	Taglio CUT	Qt.	Profilo Profile	Taglio CUT	Qt.
CX55.101 	L	2	CX70.605 					
	H	2						
CX55.203 	L-44	2						
	H-44	2						



■ **Finestra 2 Ante**
2 Sashes Window

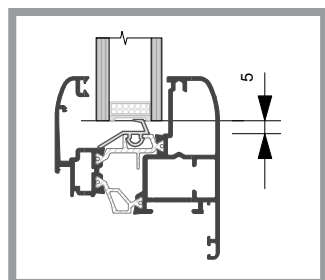
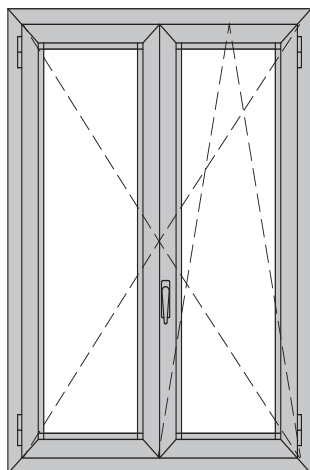

Accessori & Guarnizioni | *Accessories & Gaskets*

Art. Code	Descrizione Description	Qt.
AWX.19.SQ	Squadretta Telaio /Anta <i>Frame/door corner connection</i>	12
ARX.03.SQ	Squad. Cianfrinare EXT. <i>External riveting corner joint</i>	12
ARX.15.SQ	Squad. Allin. Telaio/Anta <i>Frame/door aligning corner joint</i>	12
ARX.10.SQ	Squad. Allin. Anta INT. <i>Internal door aligning corner joint</i>	8
ACX.02.01	Cerniera 2 Ali <i>2-leafed hinge</i>	4
ARX.03.06	Cremonese Pressofusa <i>Die-cast Cremonese bolt</i>	1
ACX.03.17	Innesti Cremonese <i>Cremonese bolt connections</i>	2
ACX.03.18	Terminale Astina <i>Bbar Terminal</i>	2
ACX.03.11	Paletto a Sinta <i>Push Latch</i>	2
ACX.03.14	Ferrogliera <i>Striker plate</i>	2
ACX.04.51	Tappo Rlporto Centrale <i>Central wing cap</i>	1
ARX.05.01	Copriaccola Scarico Acqua <i>Water drainage slot cover</i>	2
ARX.06.01	Espansore <i>Expander</i>	*
ARX.10.01	Guarnizione Precamera <i>Prechamber Gasket</i>	2L, 3H
ACX.10.04	Guarnizione Battuta <i>Rabbet window gasket</i>	2L, 4H
ARX.10.05.1	Guarnizione Vetro EXT <i>External glass window gasket</i>	2L, 4H
*	Guarnizioe Vetro INT <i>Internal glass window gasket</i>	2L, 4H
ARX.10.02	Angolo Guarnizione Precamera <i>Pre-chamber corner connection window gasket</i>	4

* Secondo Dimensioni | *Depending on size*

DISTINTA Taglio Vetri Glass Cutting List		
Qt.	H	L
2	H-150	L/2-132
Spazio/Gap 5 mm.		

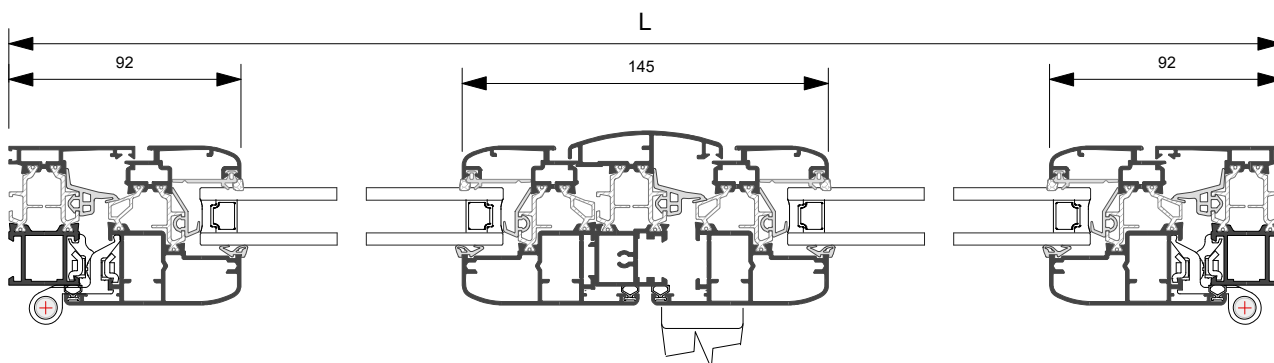
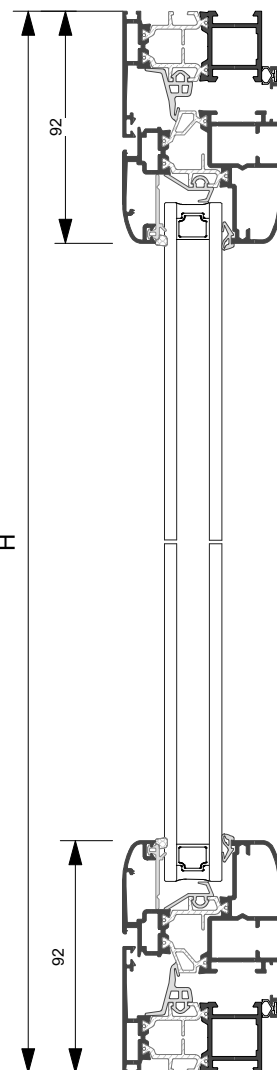

Profilo <i>Profile</i>	Taglio <i>CUT</i>	Qt.	Profilo <i>Profile</i>	Taglio <i>CUT</i>	Qt.	Profilo <i>Profile</i>	Taglio <i>CUT</i>	Qt.
 CX55.101	L	2	 CX55.301	H - 110	1			
	H	2						
 CX55.203	L/2 - 24.5	4	 CX70.605					
	H - 44	4						



■ Finestra 1 Anta
1 Sash Window

Accessori & Guarnizioni | Accessories & Gaskets

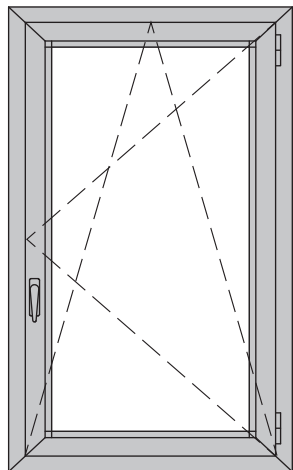

Art. Code	Descrizione Description	Qt.
AWX.19.SQ	Squadretta Telaio /Anta Frame/door corner connection	8
ARX.03.SQ	Squad. Cianfrinare EXT. External riveting corner joint	8
ARX.15.SQ	Squad. Allin. Telaio/Anta Frame/door aligning corner joint	8
ARX.10.SQ	Squad. Allin. Anta INT. Internal door aligning corner joint	4
ACX.02.01	Cerniera 2 Ali 2-leafed hinge	2
ARX.03.06	Cremonese Pressofusa Die-cast Cremonese bolt	1
ACX.03.17	Innesti Cremonese Cremonese bolt connections	2
ACX.03.18	Terminale Astina Bbar Terminal	2
ACX.03.13	Ferrogliera Striker plate	2
ARX.05.01	Copriaccola Scarico Acqua Water drainage slot cover	2
ARX.06.01	Espansore Expander	*
ACX.07.02	Angolo Pressofuso Fermavetro Die-cast glazing bead corner	4
ARX.10.01	Guarnizione Precamera Prechamber Gasket	2L, 2H
ACX.10.04	Guarnizione Battuta Rabbet window gasket	2L, 2H
ARX.10.05.1	Guarnizione Vetro EXT External glass window gasket	2L, 2H
*	Guarnizione Vetro INT Internal glass window gasket	2L, 2H
ARX.10.02	Angolo Guarnizione Precamera Pre-chamber corner connection window gasket	4

* Secondo Dimensioni | Depending on size

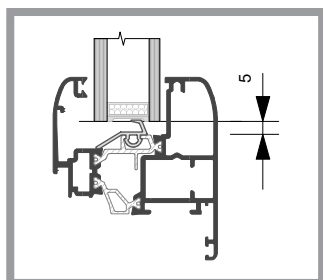

DISTINTA Taglio Vetri		
Qt.	H	L
1	H-150	L-150
Spazio/Gap 5 mm.		

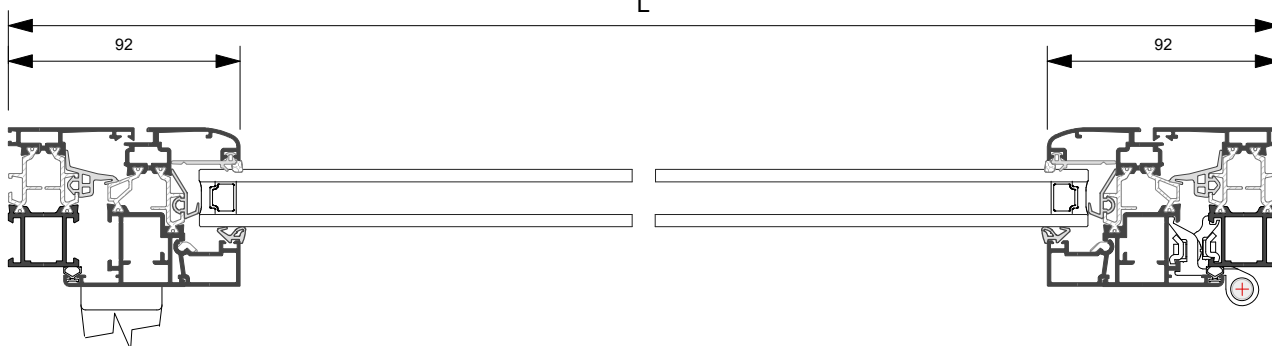
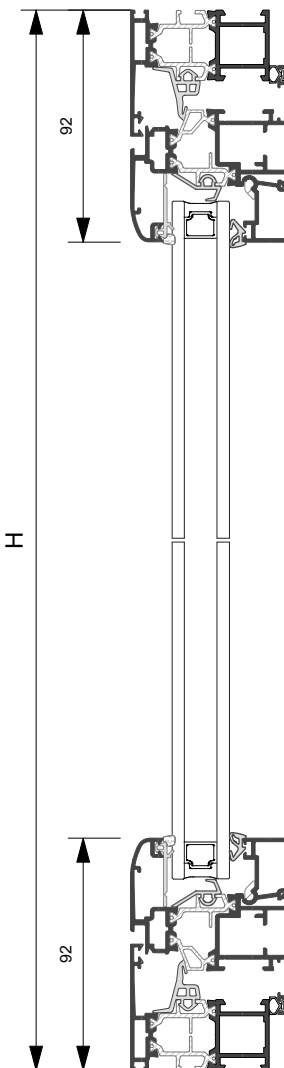

Profilo Profile	Taglio CUT	Qt.	Profilo Profile	Taglio CUT	Qt.	Profilo Profile	Taglio CUT	Qt.
CX55.101 	L	2	CX70.563 	L - 184	2			
	H	2		H - 184	2			
CX55.201 	L - 44	2	CX70.605 					
	H - 44	2						



■ Finestra 2 Ante
2 Sashes Window

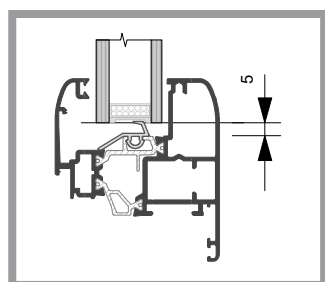
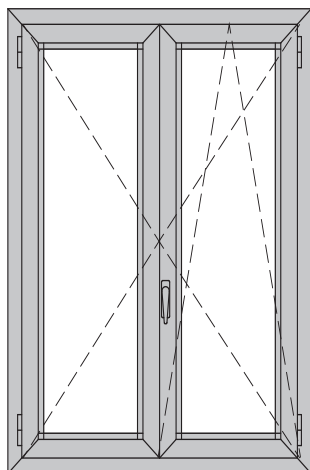

Accessori & Guarnizioni | Accessories & Gaskets

Art. Code	Descrizione Description	Qt.
AWX.19.SQ	Squadretta Telaio /Anta Frame/door corner connection	12
ARX.03.SQ	Squad. Cianfrinare EXT. External riveting corner joint	12
ARX.15.SQ	Squad. Allin. Telaio/Anta Frame/door aligning corner joint	12
ARX.10.SQ	Squad. Allin. Anta INT. Internal door aligning corner joint	8
ACX.02.01	Cerniera 2 Ali 2-leafed hinge	4
ARX.03.06	Cremonese Pressofusa Die-cast Cremonese bolt	1
ACX.03.17	Innesti Cremonese Cremonese bolt connections	2
ACX.03.18	Terminale Astina Bbar Terminal	2
ACX.03.11	Paletto a Sinta Push Latch	2
ACX.03.14	Ferrogliera Striker plate	2
ACX.04.51	Tappo RIporto Centrale Central wing cap	1
ARX.05.01	Copriaccola Scarico Acqua Water drainage slot cover	2
ARX.06.01	Espansore Expander	*
ACX.07.02	Angolo Pressofuso Fermavetro Die-cast glazing bead corner	8
ARX.10.01	Guarnizione Precamera Prechamber Gasket	2L, 3H
ACX.10.04	Guarnizione Battuta Rabbet window gasket	2L, 4H
ARX.10.05.1	Guarnizione Vetro EXT External glass window gasket	2L, 4H
*	Guarnizione Vetro INT Internal glass window gasket	2L, 4H
ARX.10.02	Angolo Guarnizione Precamera Pre-chamber corner window gasket	4
ACX.10.81	Isolante Sottovetro Under glass insulation	2L, 4H

* Secondo Dimensioni | Depending on size

DISTINTA Taglio Vetri Glass Cutting List		
Qt.	H	L
2	H-150	L/2-132
Spazio/Gap 5 mm.		

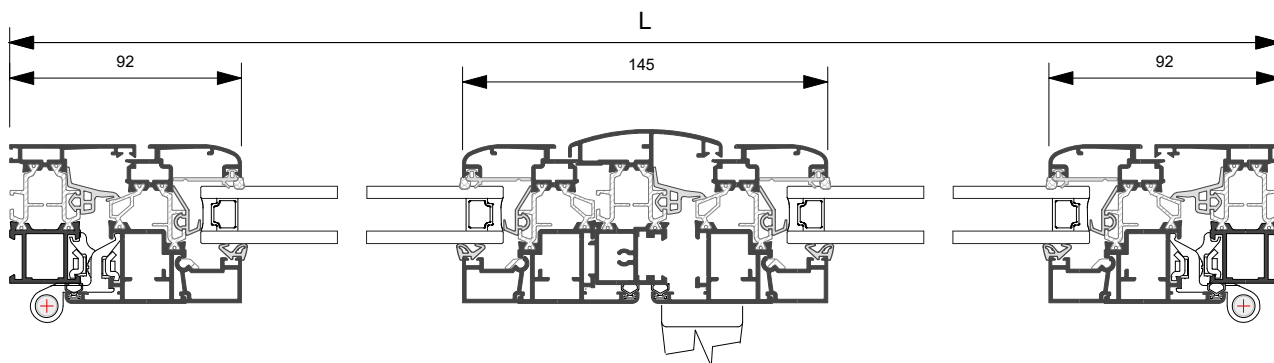
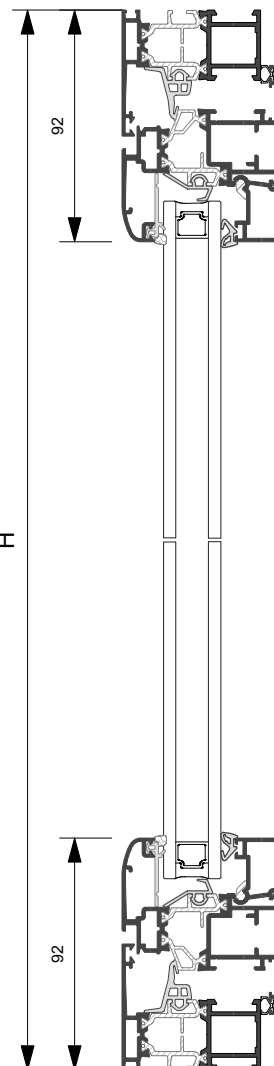

Profilo Profile	Taglio CUT	Qt.	Profilo Profile	Taglio CUT	Qt.	Profilo Profile	Taglio CUT	Qt.
CX55.101 	L	2	CX70.563 	L/2 - 164.5	4	CX70.605 		
	H	2		H - 180	4			
CX55.201 	L/2 - 24.5	4	CX55.301 	H - 110	1			
	H - 44	4						



■ Porta 1 Anta
1 Sash Door

Accessori & Guarnizioni | Accessories & Gaskets

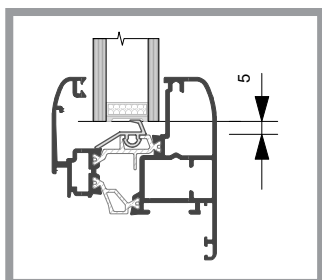
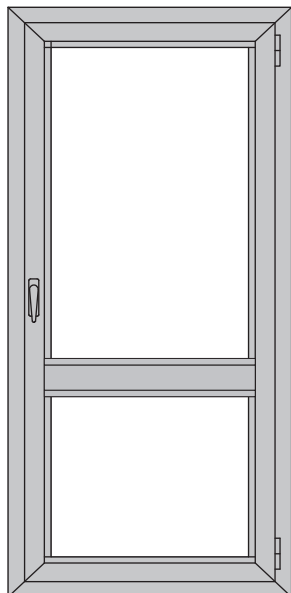

Art. Code	Descrizione Description	Qt.
AWX.19.SQ	Squadretta Telaio /Anta Frame/door corner connection	8
ARX.03.SQ	Squad. Cianfrinare EXT. External riveting corner joint	8
ARX.15.SQ	Squad. Allin. Telaio/Anta Frame/door aligning corner joint	8
ARX.10.SQ	Squad. Allin. Anta INT. Internal door aligning corner joint	4
ACX.02.01	Cerniera 2 Ali 2-leafed hinge	3
ARX.03.06	Cremonese Pressofusa Die-cast Cremonese bolt	1
ACX.03.17	Innesti Cremonese Cremonese bolt connections	2
ACX.03.18	Terminale Astina Bbar Terminal	2
ACX.03.13	Ferrogliera Striker plate	2
ARX.05.01	Copriaccola Scarico Acqua Water drainage slot cover	2
ARX.06.01	Espansore Expander	*
ACX.07.02	Angolo Pressofuso Fermavetro Die-cast glazing bead corner	8
ACX.10.01	Guarnizione Precamera Prechamber Gasket	2L, 2H
ACX.10.04	Guarnizione Battuta Rabbet window gasket	2L, 2H
ARX.10.05.1	Guarnizione Vetro EXT External glass window gasket	4L, 2H
*	Guarnizione Vetro INT Internal glass window gasket	4L, 2H
ARX.10.02	Angolo Guarnizione Precamera Pre-chamber corner connection window gasket	4

* Secondo Dimensioni | Depending on size

DISTINTA Taglio Vetri Glass Cutting List		
Qt.	H	L
1	H-H_{fa}-58	L - 150
1	H_{fa}-154	L - 150

Spazio/Gap 5 mm.

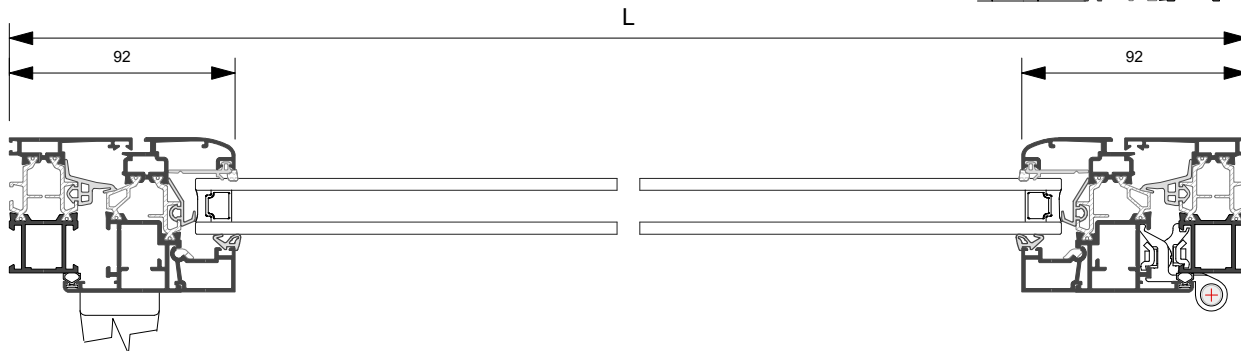
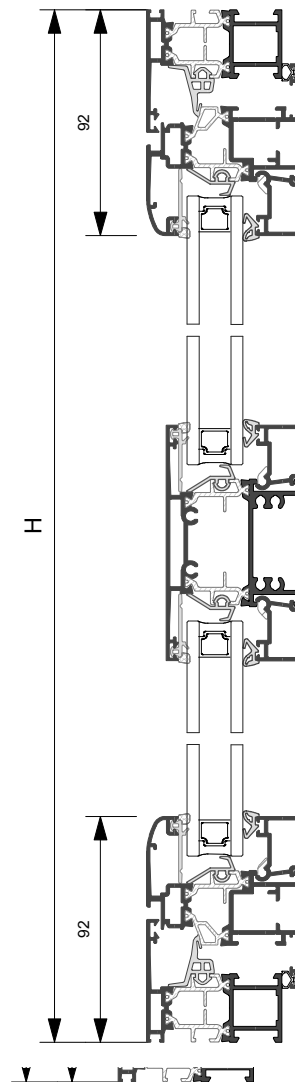

Profilo Profile	Taglio CUT	Qt.	Profilo Profile	Taglio CUT	Qt.	Profilo Profile	Taglio CUT	Qt.
CX55.101 	L	2	CX70.563 	L - 184	4		L - 130	1
	H	2		H - H_{fa} - 92	2			
CX55.201 	L - 44	2		H_{fa} - 188	2			
	H - 44	2	CX70.605 					



■ Porta 2 Ante
2 Sashes Door

Accessori & Guarnizioni | Accessories & Gaskets

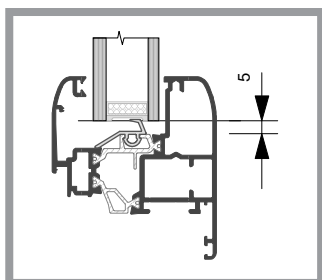
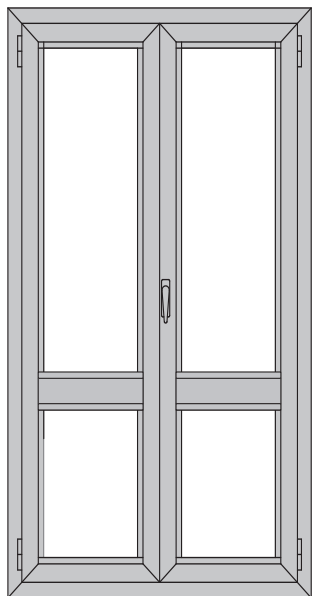

Art. Code	Descrizione Description	Qt.
AWX.19.SQ	Squadretta Telaio /Anta Frame/door corner connection	12
ARX.03.SQ	Squad. Cianfrinare EXT. External riveting corner joint	12
ARX.15.SQ	Squad. Allin. Telaio/Anta Frame/door aligning corner joint	12
ARX.10.SQ	Squad. Allin. Anta INT. Internal door aligning corner joint	8
ACX.02.01	Cerniera 2 Ali 2-leafed hinge	6
ARX.03.06	Cremonese Pressofusa Die-cast Cremonese bolt	1
ACX.03.17	Innesti Cremonese Cremonese bolt connections	2
ACX.03.18	Terminale Astina Bbar Terminal	2
ACX.03.11	Paletto a Sinta Push Latch	2
ACX.03.14	Ferrogliera Striker plate	2
ACX.04.51	Tappo Riporto Centrale Central wing cap	1
ARX.05.01	Copriasola Scarico Acqua Water drainage slot cover	2
ARX.06.01	Espansore Expander	*
ACX.07.02	Angolo Pressofuso Fermavetro Die-cast glazing bead corner	16
ARX.10.01	Guarnizione Precamera Prechamber Gasket	2L, 3H
ACX.10.04	Guarnizione Battuta Rabbet window gasket	2L, 4H
ARX.10.05.1	Guarnizione Vetro EXT External glass window gasket	4L, 4H
*	Guarnizione Vetro INT Internal glass window gasket	4L, 4H
ARX.10.02	Angolo Guarnizione Precamera Pre-chamber corner window gasket	4

* Secondo Dimensioni | Depending on size

DISTINTA Taglio Vetri Glass Cutting List		
Qt.	H	L
1	H - H _{Fa} - 58	L/2 - 130
2	H _{Fa} - 154	L/2 - 130
Spazio/Gap 5 mm.		

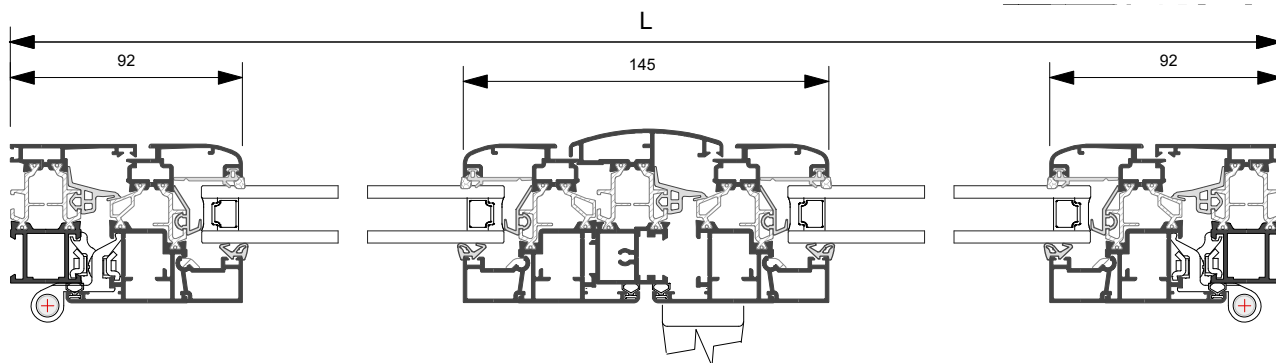
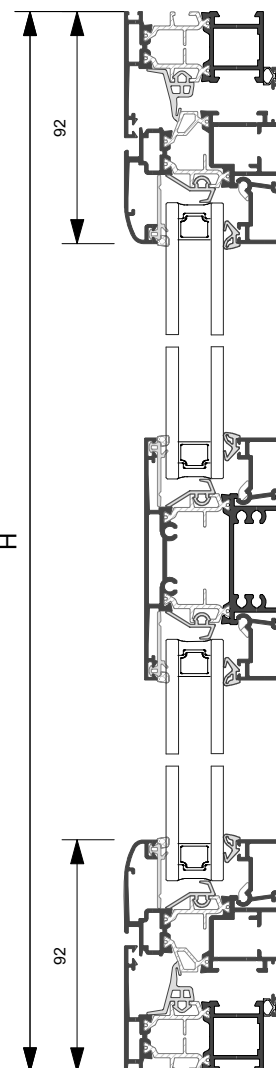

Profilo Profile	Taglio CUT	Qt.	Profilo Profile	Taglio CUT	Qt.	Profilo Profile	Taglio CUT	Qt.
CX55.101 	L	2	CX70.563 	L/2 - 164.5	8	CX55.301 	H - 110	1
	H	2		H - H _{Fa} - 92	4			
CX55.201 	L/2 - 24.5	4		CX70.605 	H _{Fa} - 188	4	CX55.402 	L/2 - 110.5
	H - 44	2			1			



Attacco alla Muratura
Connection to Brickwork

Gruppo F

Sezione particolareggiata
attacco alla muratura

Wall Joint Detail

SCHEMA FISSAGGIO | *Fixing*
Tipo A | *Type A*

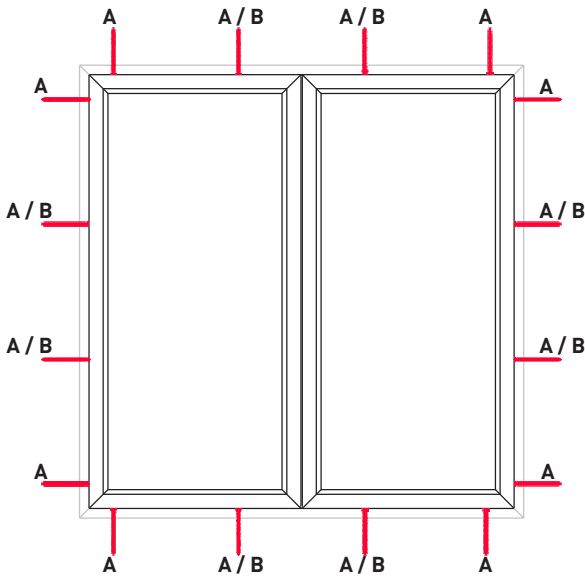

- ▶ **DAGLI ANGOLI** | *From the CORNERS = 150 mm.*
- ▶ **INTERASSE** | *Center Distance = 700 mm.*
- ▶ **FISSAGGI MINIMI** | *Minimum Fasteners = 8 Fasteners*
Verticale = 3 Fissaggi /Lato | *Vertical = 3 Fasteners/ Side*
Orizzontale = 1 Fissaggio/Lato | *Horizontal = Fasteners/Side*

ARX.06.13 REGISTRO TELAIO TWIN AUTOBLOCCANTE SU BARRETTE
TWIN frame register self-Locking on bars

PUNTA 2 DIAMETRI
Tip 2 diameters

LAMATORE
LAMATOR

Codice	d1/d2	d	Lf	Lt
PFFE03A034059	7/15	10	100	35

Codice	d1	Lf	Lt
13459	21	27	15

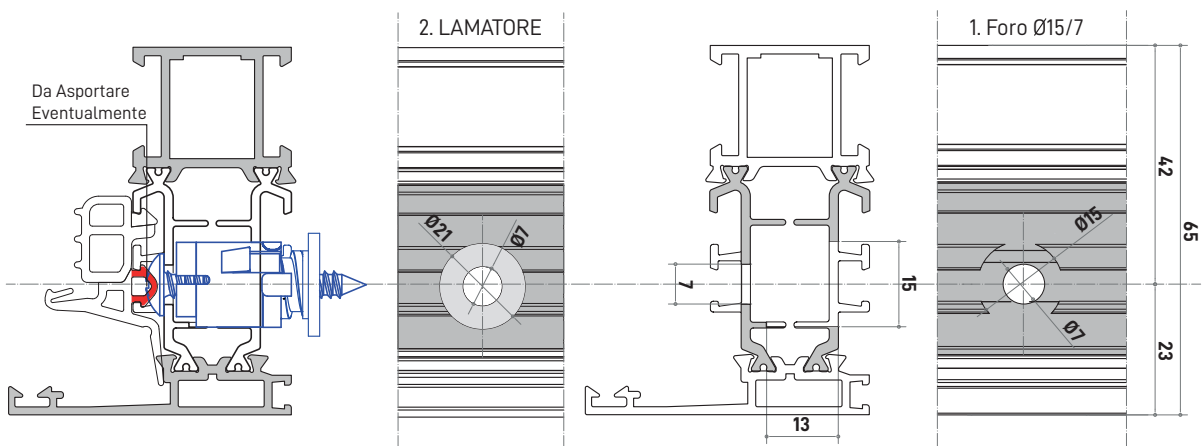
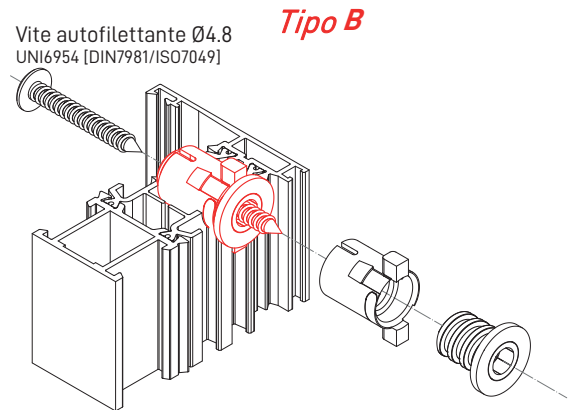
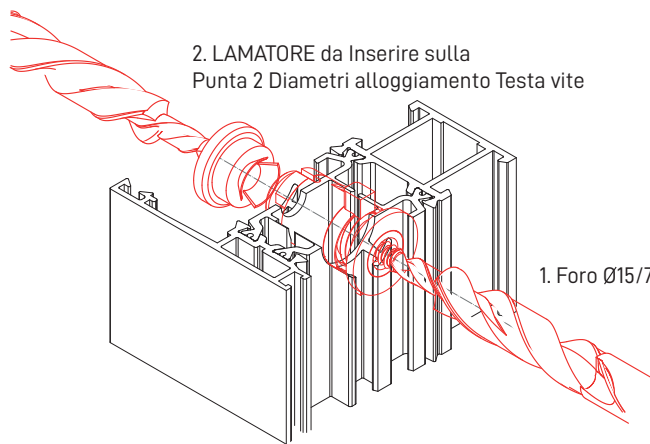



FISSAGGIO ALLA MURATURA
Fixing to the wall

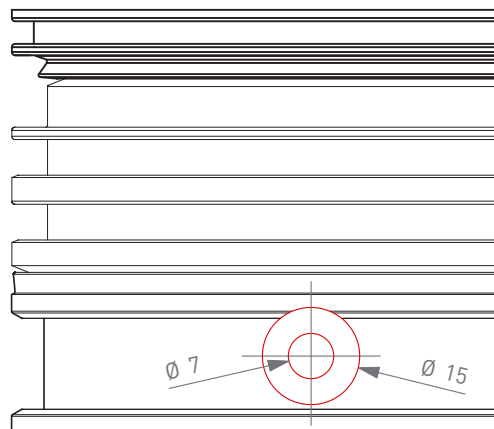
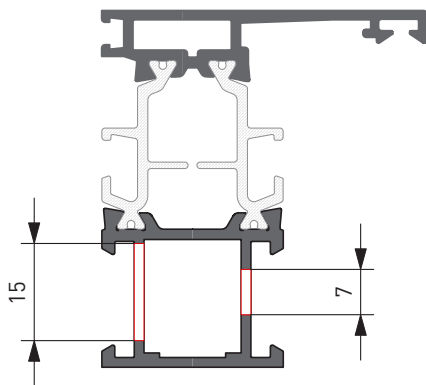
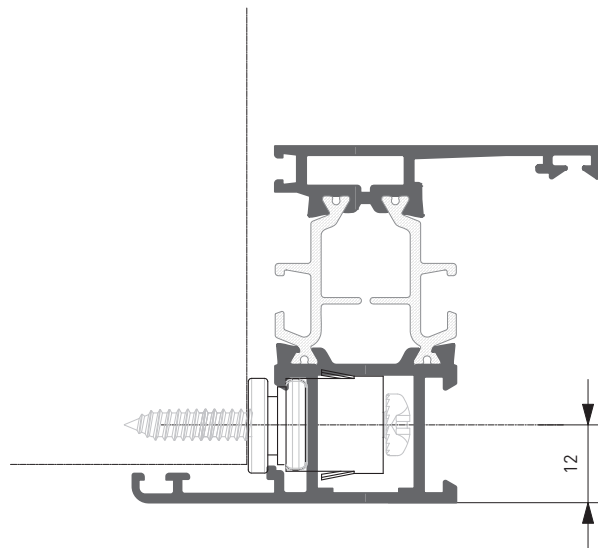
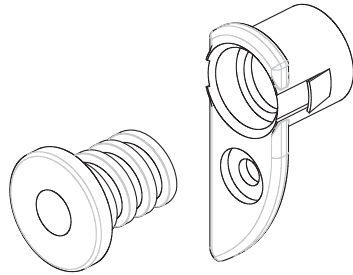







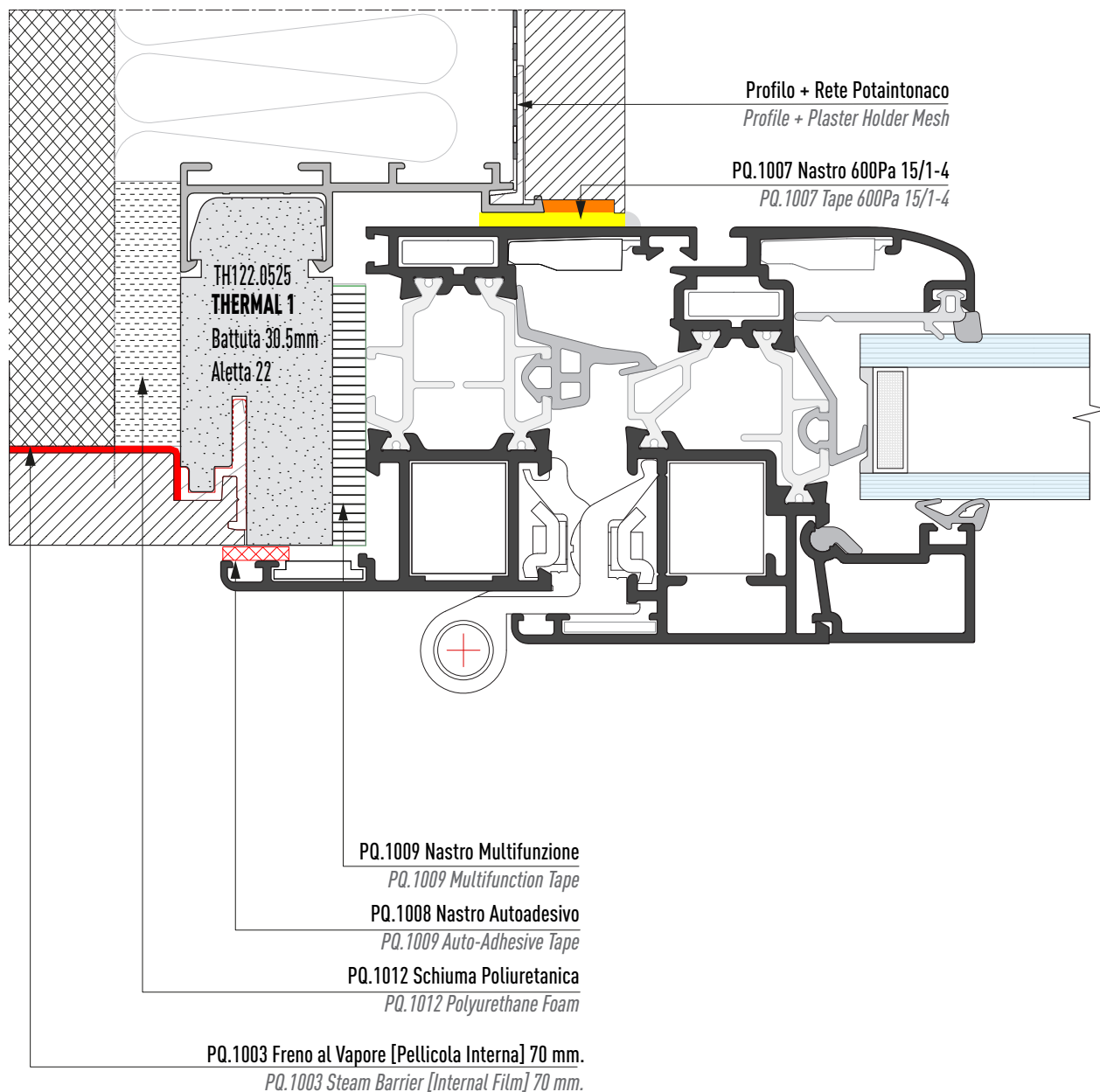

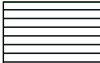

■ SEZIONE ORIZZONTALE

POSA QUALITÀ

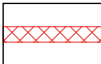

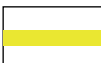
■ LEGENDA MATERIALI

 Muratura <i>Brickwall</i>	 Controtelaio THERMAL <i>Wall frame THERMAL</i>	 PQ.1012 Schiuma Poliuretanicca <i>PQ.1012 Polyurethane Foam</i>
 Intonaco <i>Plaster</i>	 PQ.1008 Nastro Autoadesivo 9x2 <i>PQ.1008 Auto-Adhesive Tape 9x2</i>	 PQ.1003 Freno al Vapore [Pellicola Interna] 70 mm. <i>PQ.1003 Steam Barrier [Internal Film] 70 mm.</i>
 Isolamento <i>Insulation</i>	 PQ.1007 Nastro 600Pa 15/1-4 <i>PQ.1007 Tape 600Pa 15/1-4</i>	 Sigillante Ibrido <i>Hybrid Sealant</i>









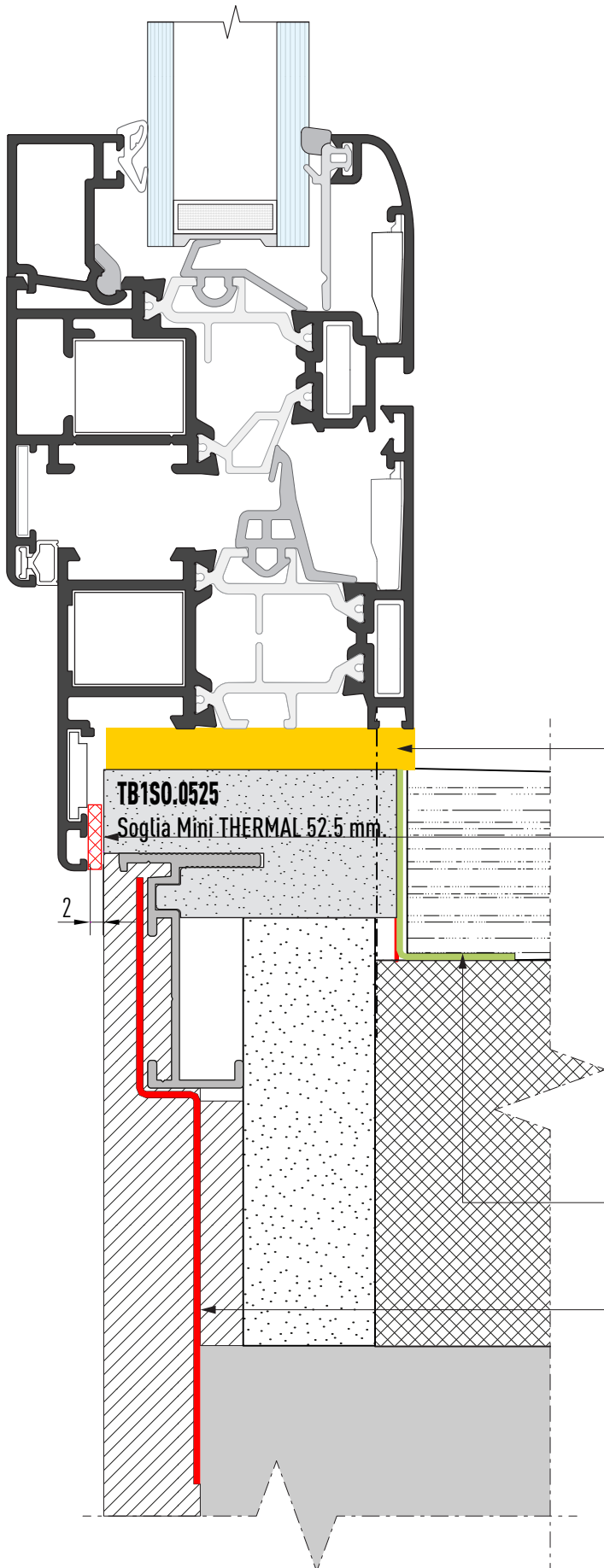

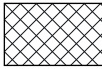
■ SEZIONE VERTICALE

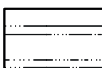
■ LEGENDA MATERIALI

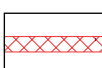
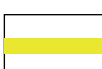
POSA QUALITÀ

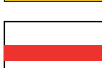

-  Muratura
Brickwall
-  Intonaco
Plaster
-  Soglia
Threshold
-  Controtelaio THERMAL
Wall frame THERMAL
-  PQ.1008 Nastro Autoadesivo 9x2
PQ.1008 Auto-Adhesive Tape 9x2
-  PQ.1007 Nastro 600Pa 15/1-4
PQ.1007 Tape 600Pa 15/1-4
-  PQ.1012 Schiuma Poliuretanic
PQ.1012 Polyurethane Foam
-  PQ.1003 Freno al Vapore [Pellicola Interna] 70 mm.
PQ.1003 Steam Barrier [Internal Film] 70 mm.
-  PQ.1005 Guaina Esterna EPDM 80 mm.
PQ.1003 External Sheath EPDM 80 mm.

PQ.1010 Nastro PE 60x6 mm.
PQ.1010 Tape PE 60x6 mm.

PQ.1008 Nastro PE 9x2 mm.
PQ.1008 Tape PE 9x2 mm.

PQ.1005 Guaina Esterna EPDM 80 mm.
PQ.1003 External Sheath EPDM 80 mm.

PQ.1003 Pellicola Interna 70 mm.
PQ.1003 Internal Film 70 mm.

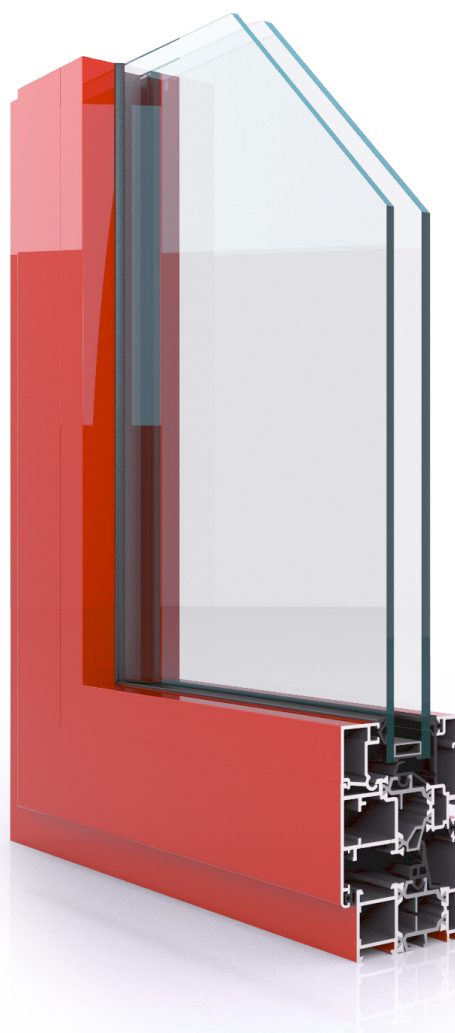

Lavorazioni e Montaggi
Tooling and Assembly

Gruppo **G**

Schemi Lavorazioni
Frese
Attrezzatura

Tooling Systems
Cutters Equipments
Milling



Pressette

Mills

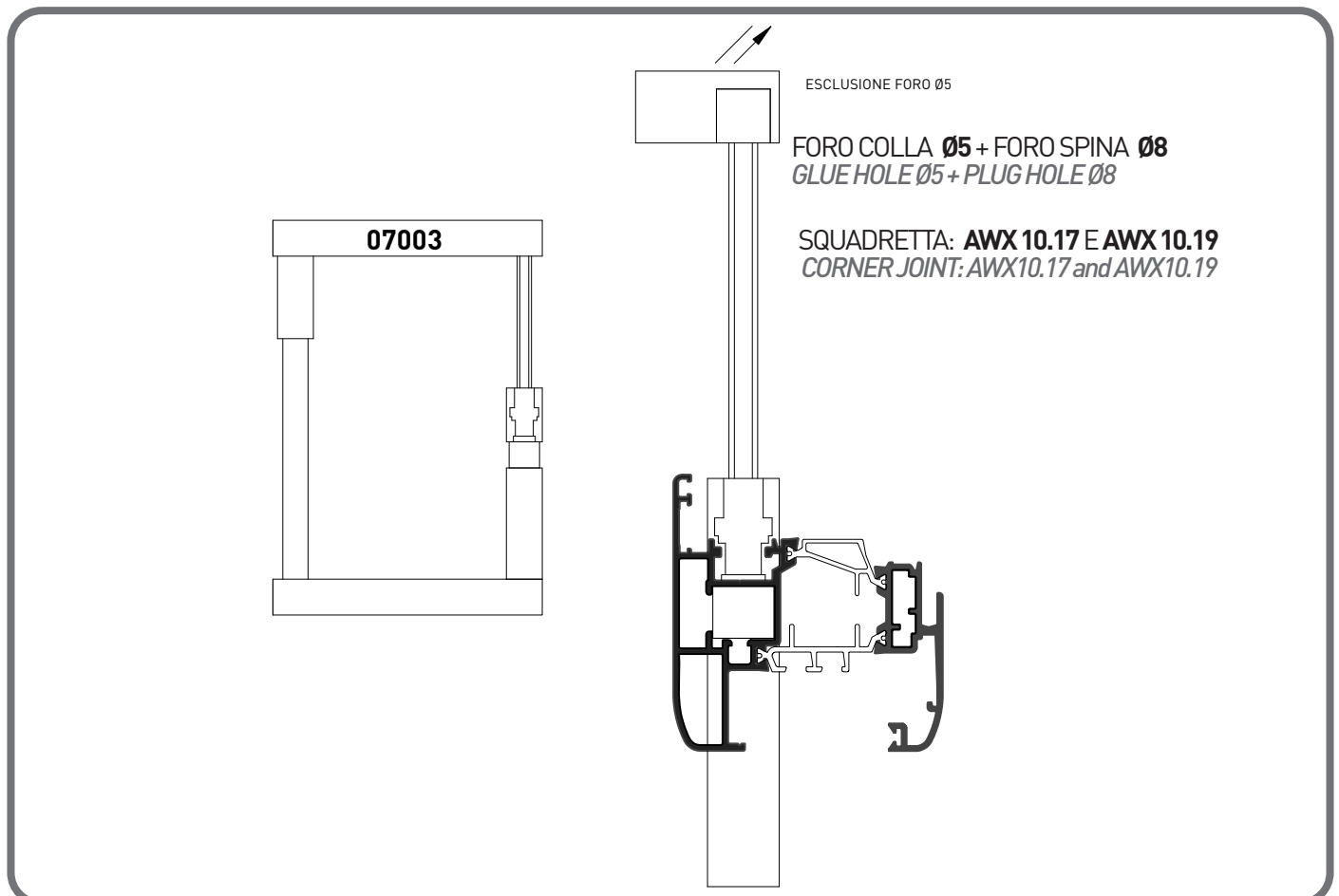
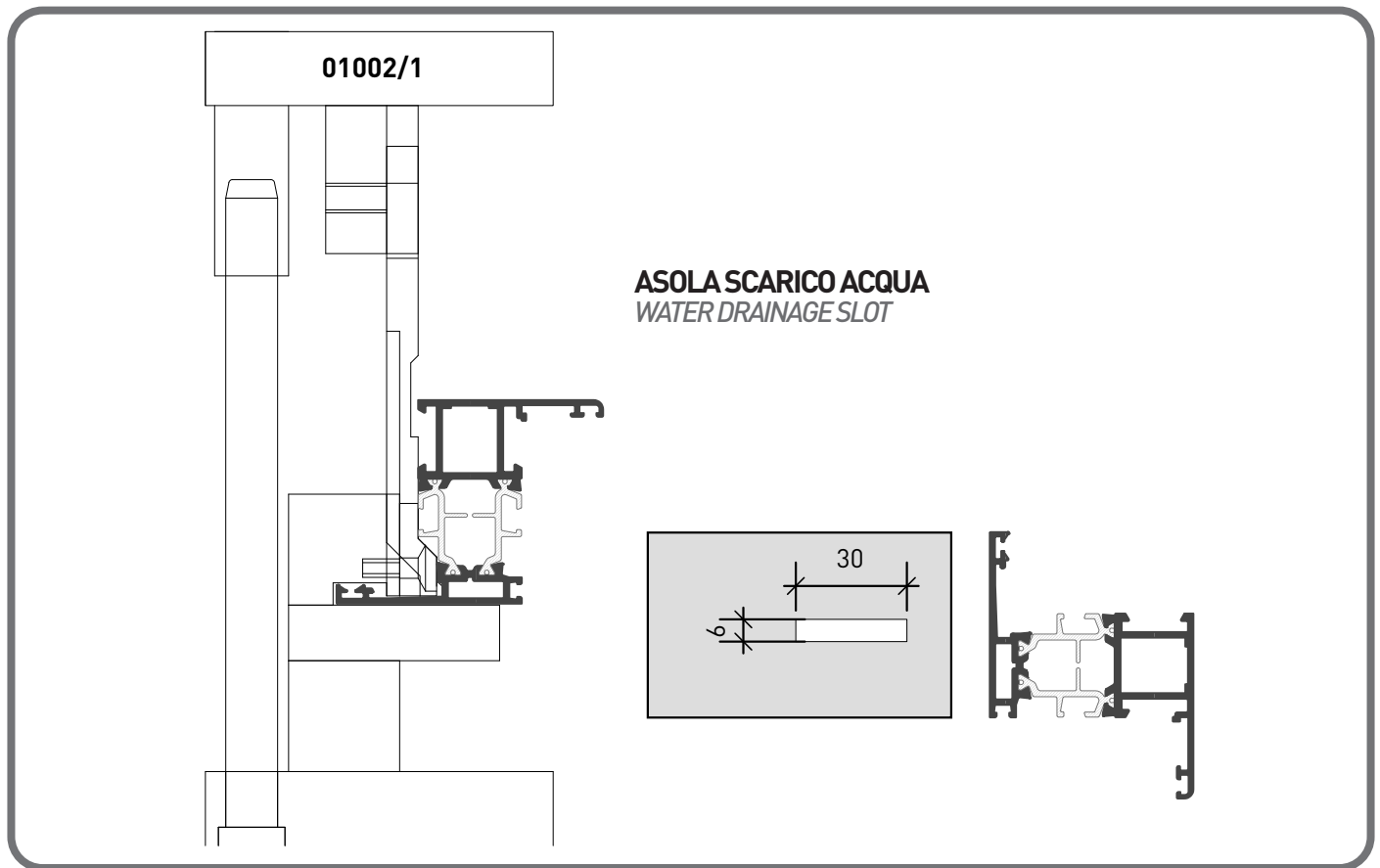

Pressette

Mills

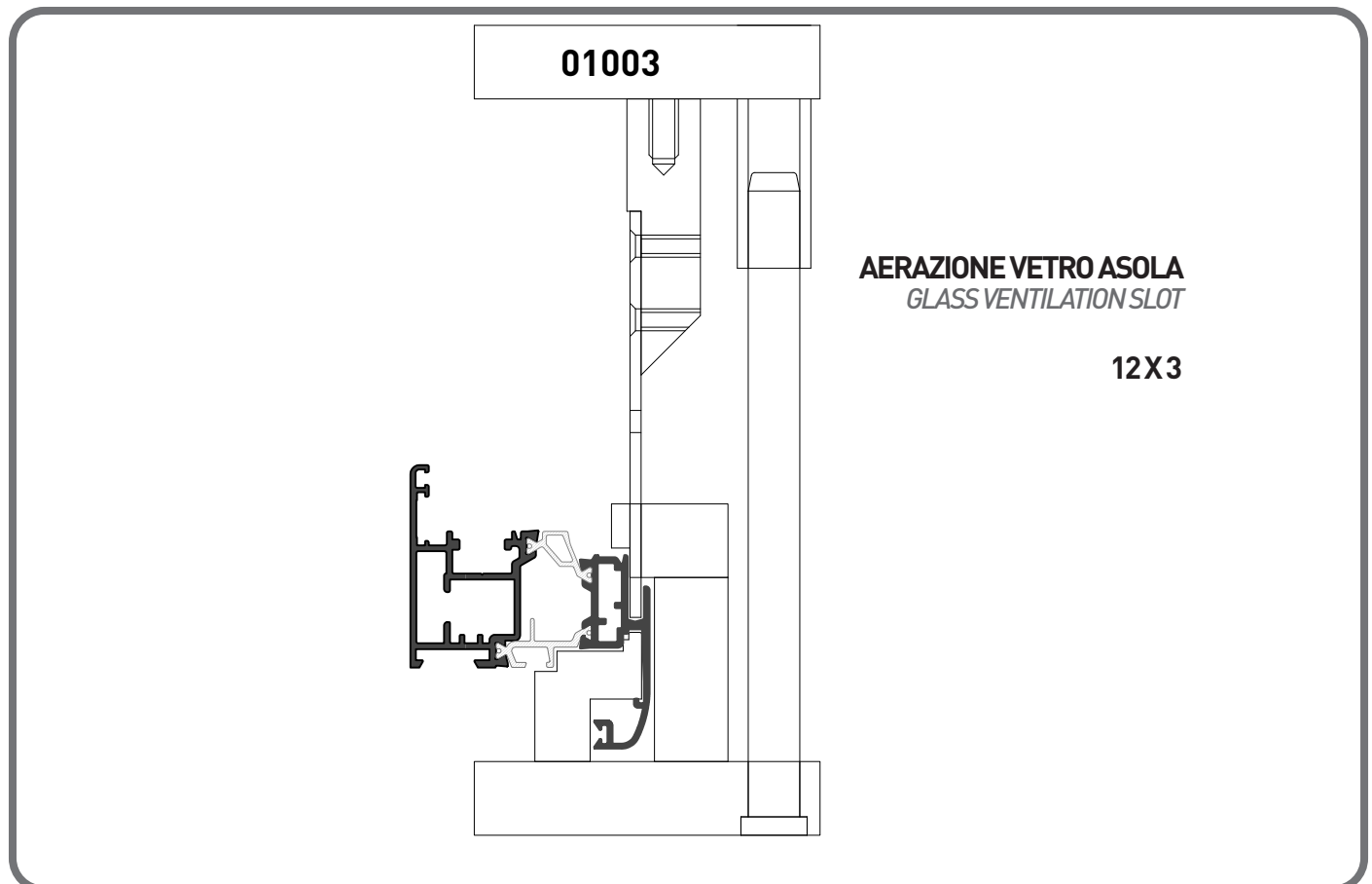
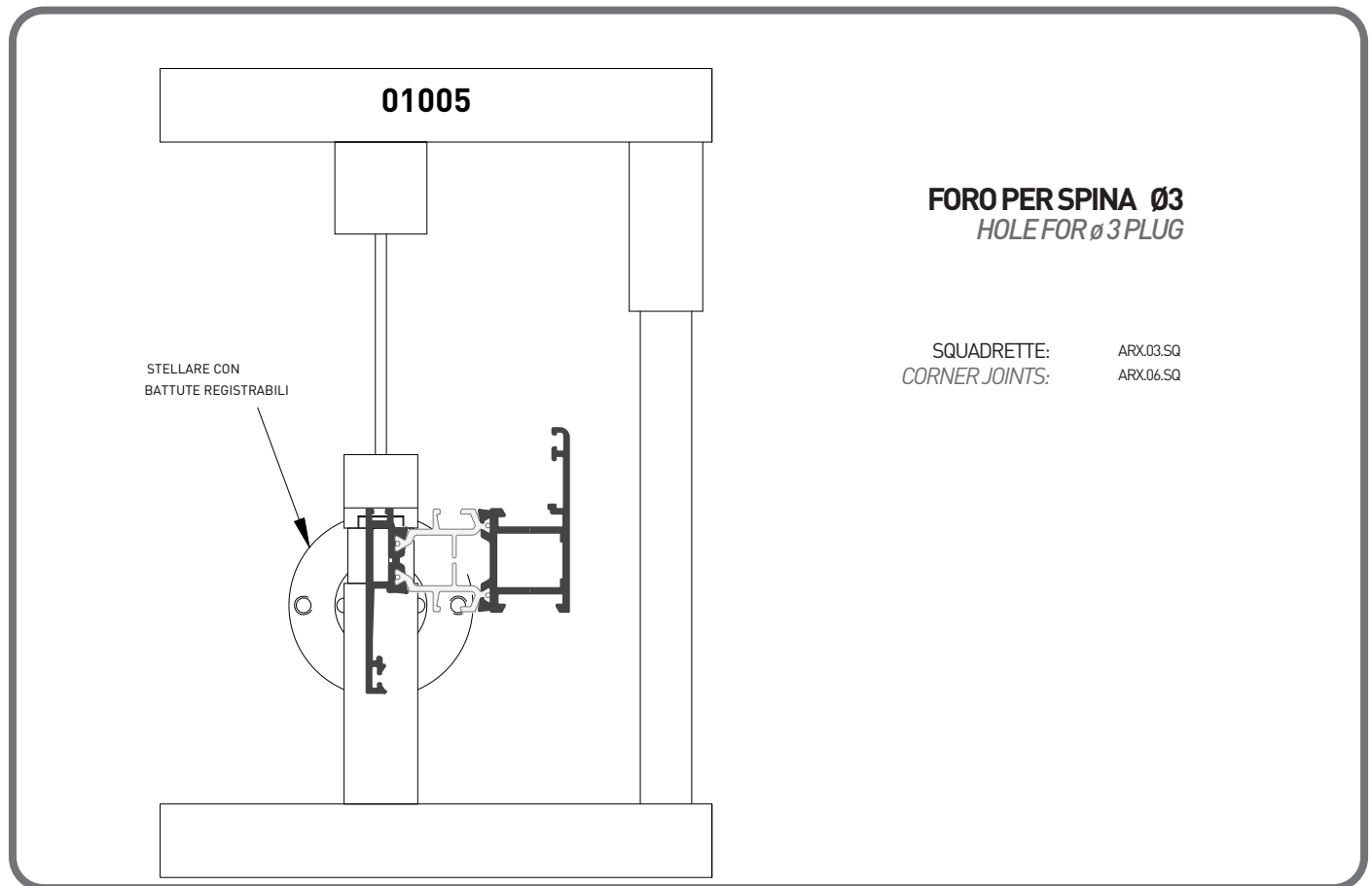



Pressette

Mills

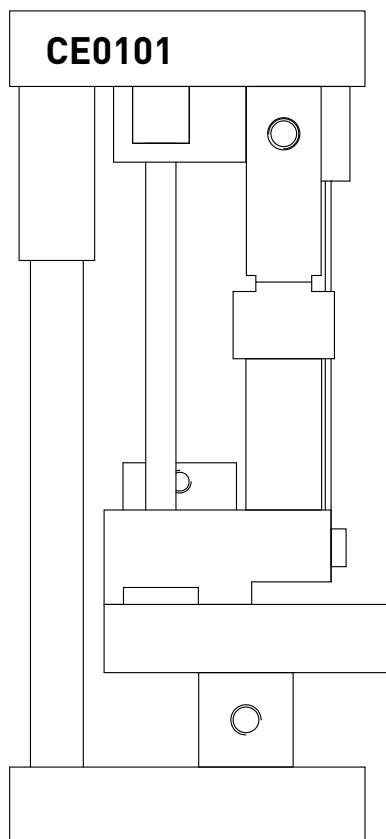

CE0101

LAVORAZIONI
TOOLING

- LAVORAZIONE CREMONESE DA 104 mm
- CREMONESE BOLT TOOLING 104mm
- FORO Ø8 DI TESTA E PASSANTE, DOPPIO FORO DA Ø8 SU ASTINA
- Ø8 HEAD AND THROUGH HOLE, DOUBLE Ø8 HOLE ON BAR
- ASPORTAZIONE DENTINI PASSAGGIO ASTA
- REMOVAL OF BAR PASSING TEETH

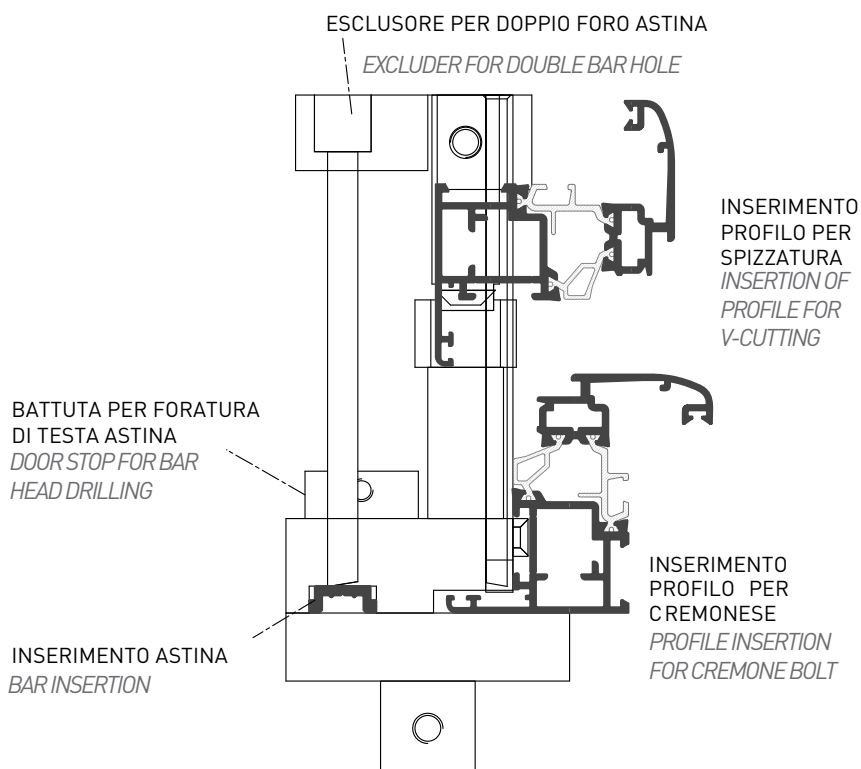



Pressette

Mills

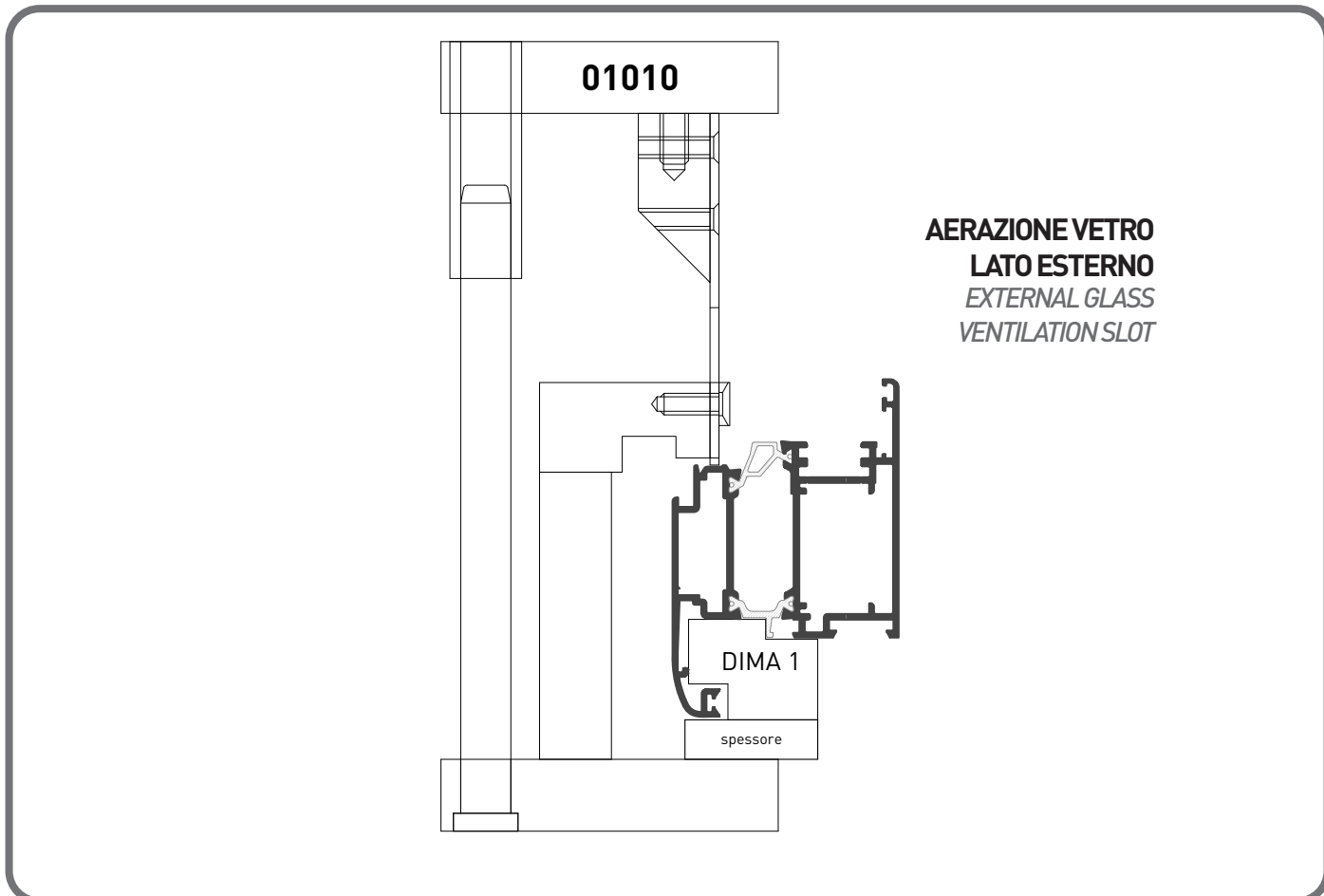
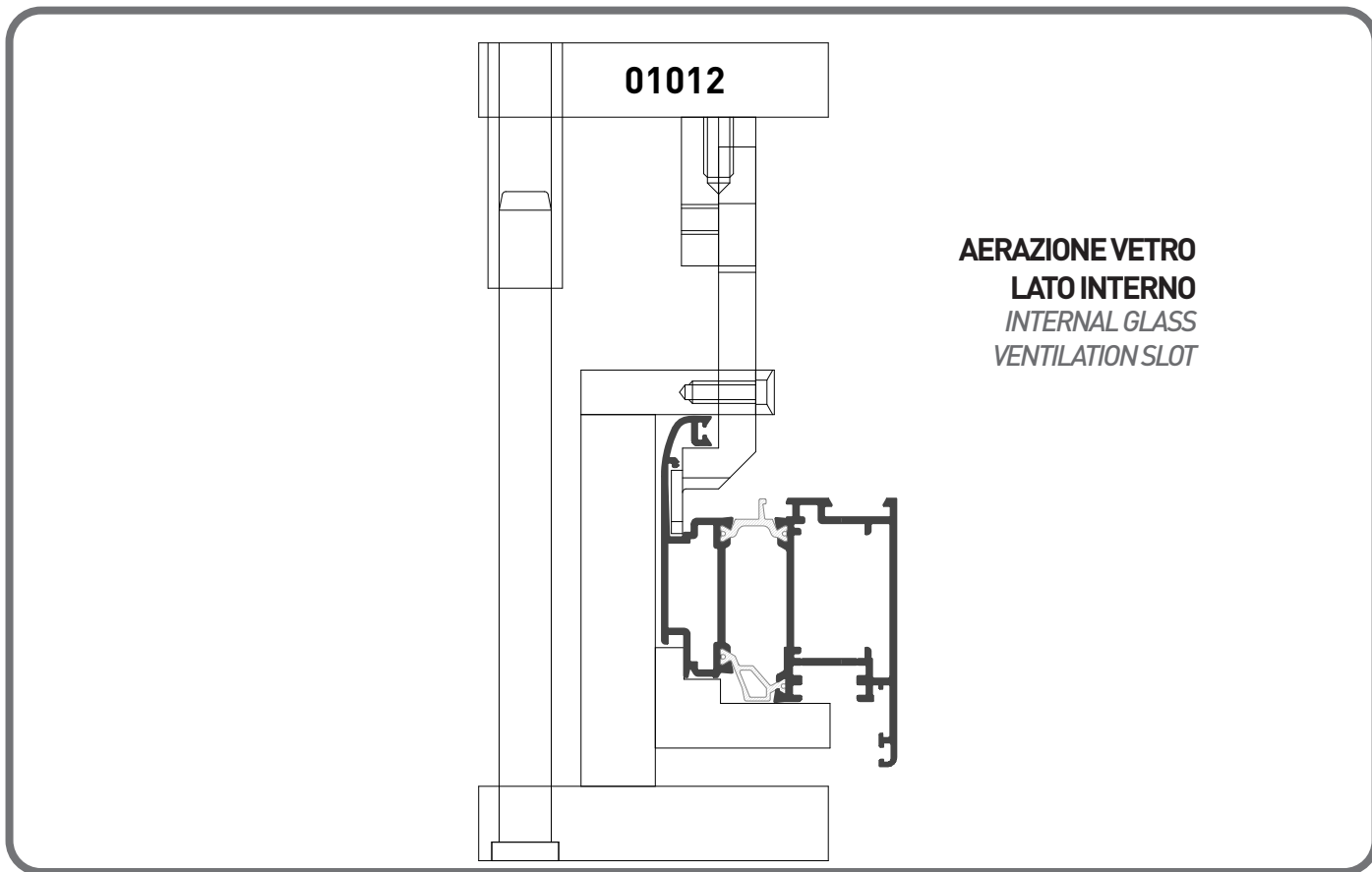



Pressette

Mills

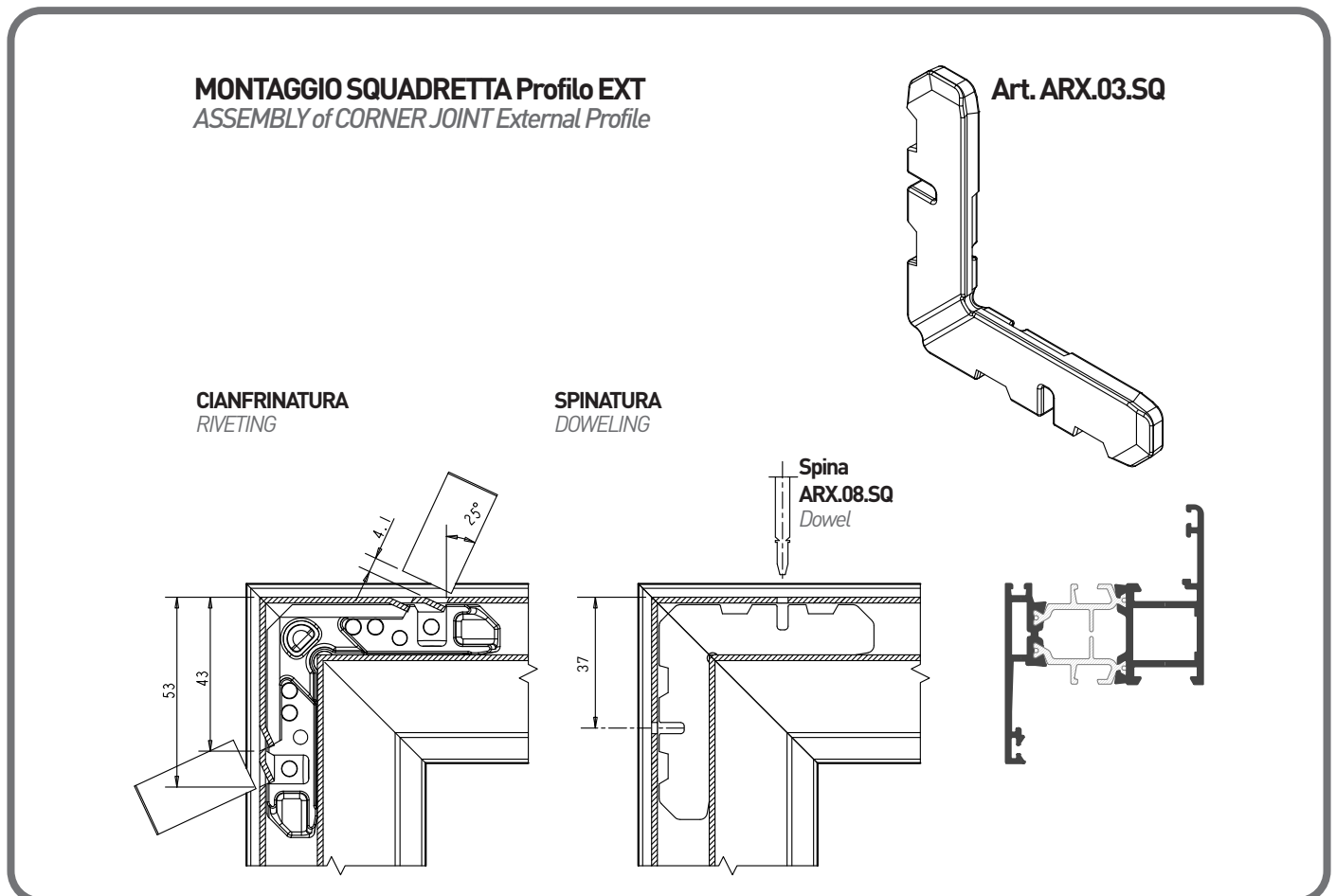
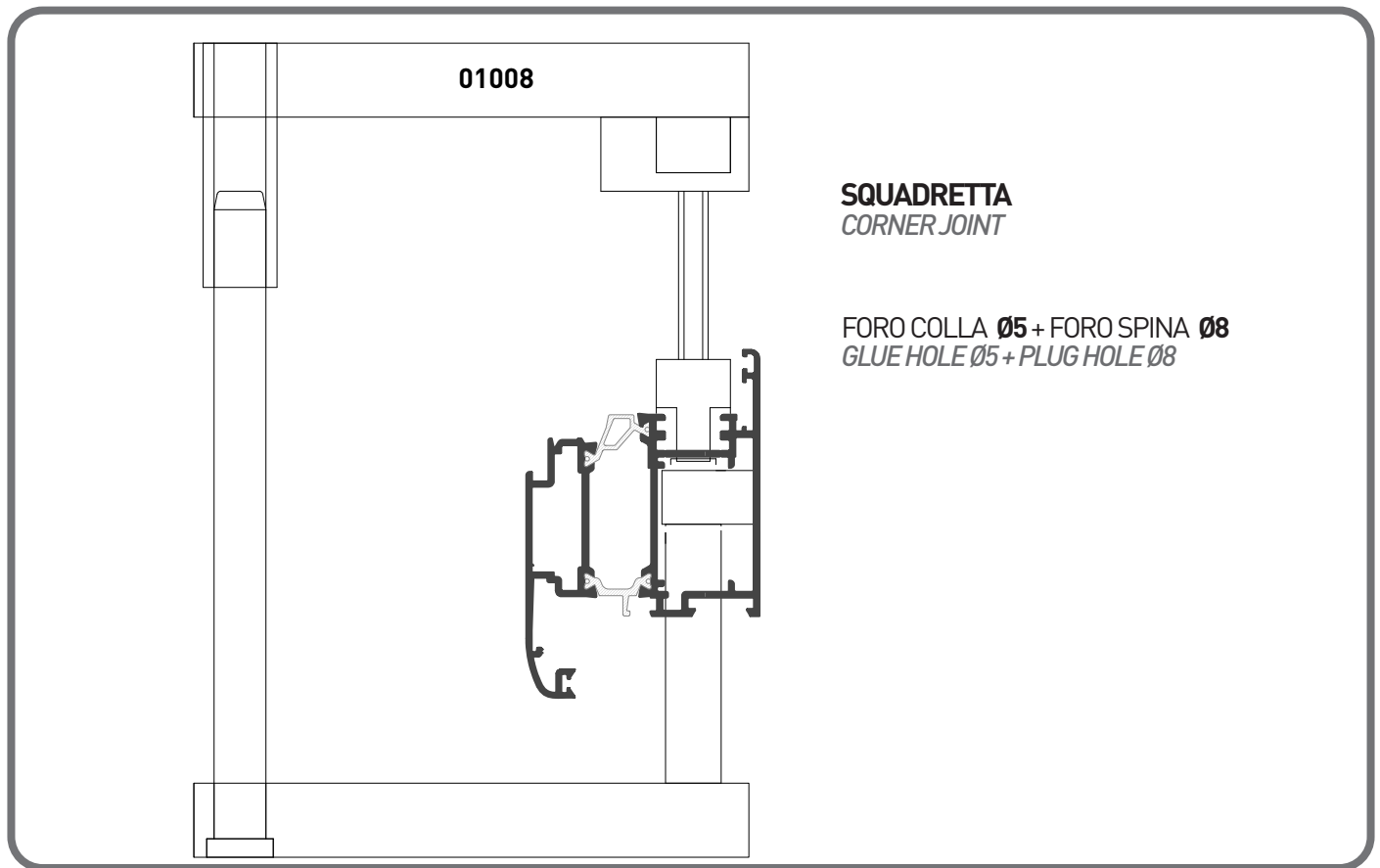

Applicazione Accessori

Accessories Application

MONTAGGIO SQUADRETTA Profilo EXT
ASSEMBLY of CORNER JOINT External Profile

ARX.06.SQ

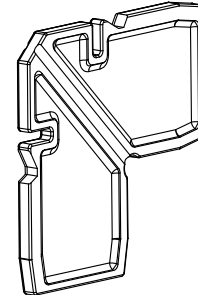

CIANFRINATURA
RIVETING

SPINATURA
DOWELING

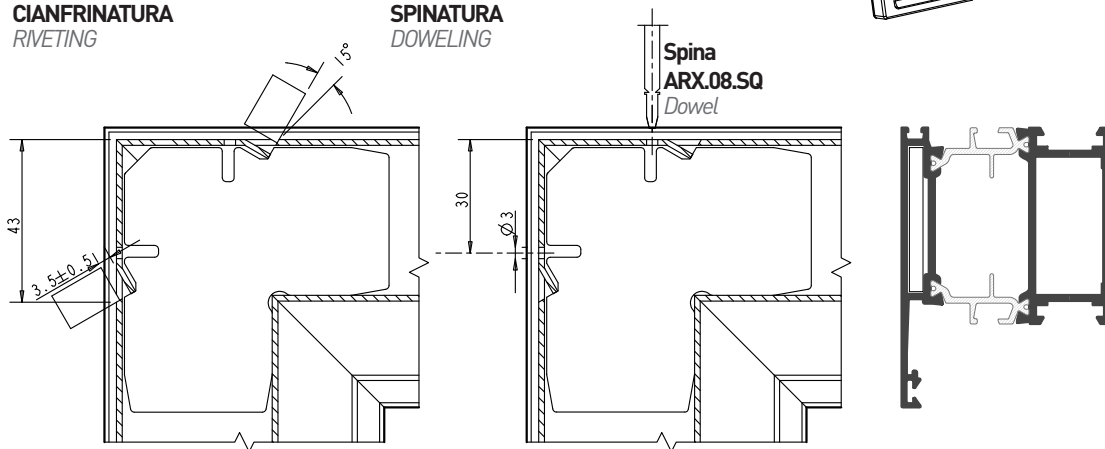

MONTAGGIO SQUADRETTA A PULSANTE Profilo INT
ASSEMBLY OF SLOT CORNER JOINT Internal Profile

ARX.16.SQ

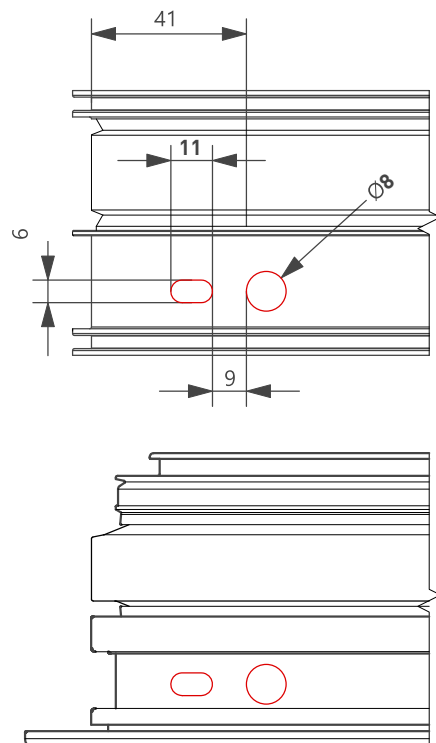
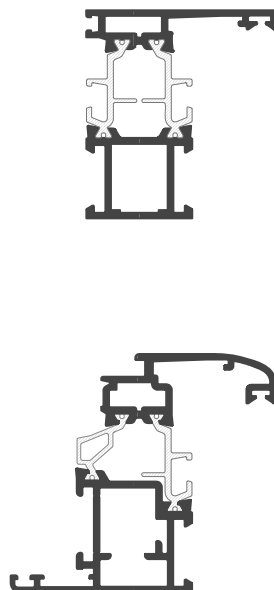
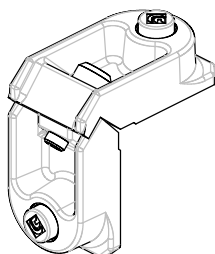

Applicazione Accessori

Accessories Application

MONTAGGIO SQUADRETTA SPINARE, CIANFRINARE ED AVITARE
ASSEMBLY of CORNER JOINT DOWELING, RIVETING, TIGHTENING

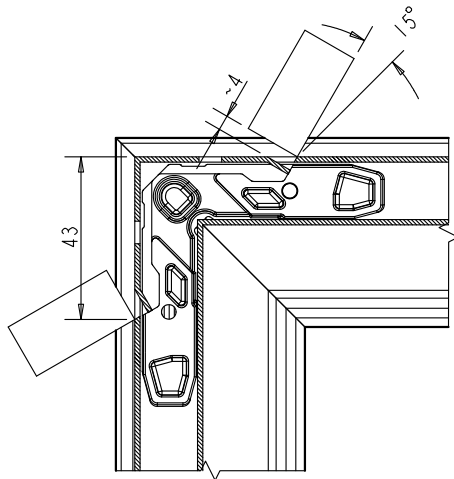

CIANFRINATURA Coltello 10 mm
RIVETING Knife 10 mm

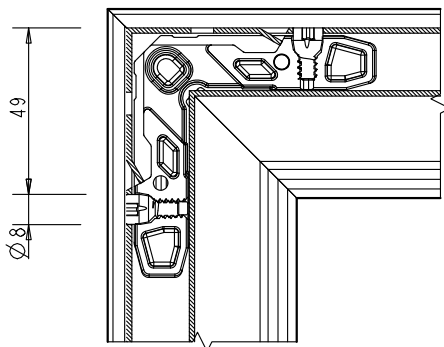

AVITATURA VIL M5X14_D8
TIGHTENING VIL M5X14_D8

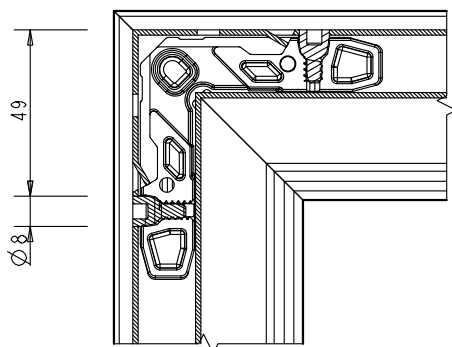

SPINATURA
SPINA ARX.07.SQ [LM0088]
DOWELING
DOWEL ARX.07.SQ [LM0088]

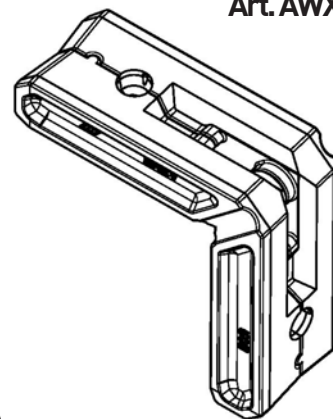

Art. AWX.19.SQ

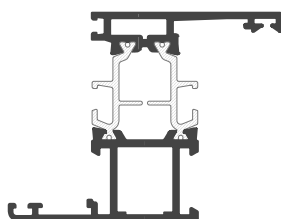

Applicazione Accessori

Accessories Application

MONTAGGIO SQUADRETTA SPINARE, CIANFRINARE ED AVITARE
ASSEMBLY of CORNER JOINT DOWELING, RIVETING, TIGHTENING

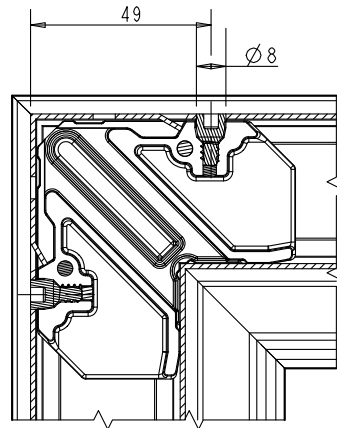

SPINATURA
SPINA ARX.07.SQ [LM0088]
DOWELING
DOWEL ARX.07.SQ [LM0088]

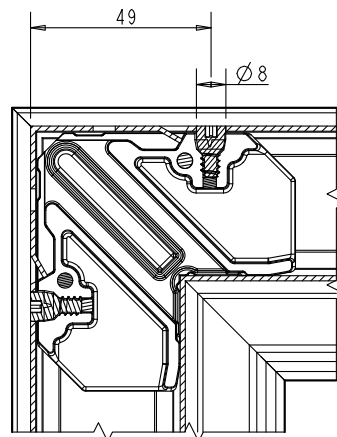

AVITATURA VIL M5X14_D8
TIGHTENING VIL M5X14_D8

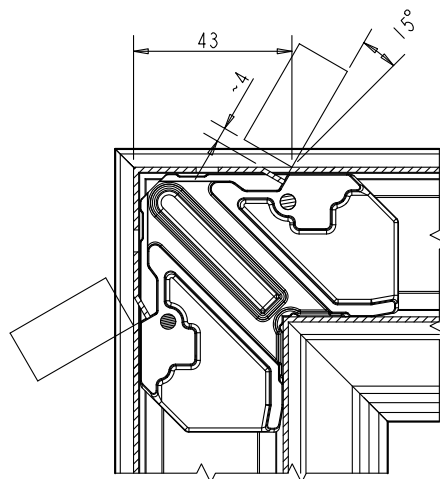

CIANFRINATURA Coltello 10 mm
RIVETING Knife 10 mm

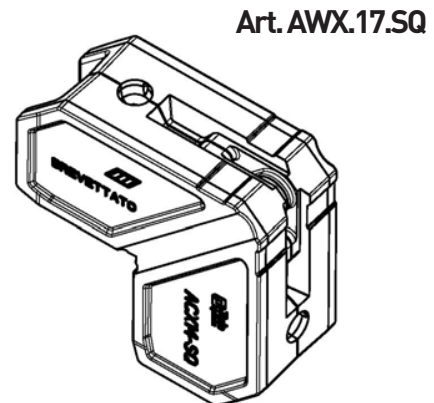
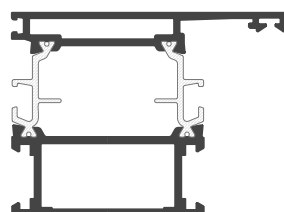

Applicazione Accessori

Accessories Application

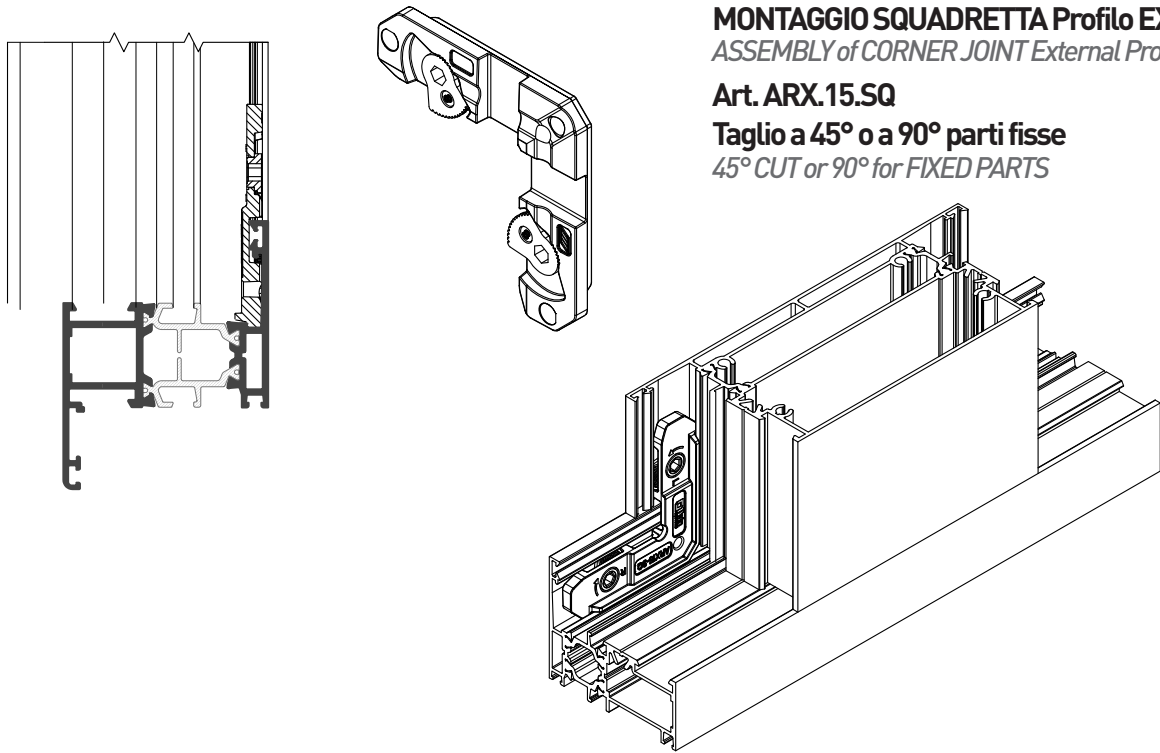

MONTAGGIO SQUADRETTA Profilo EXT
ASSEMBLY of CORNER JOINT External Profile

Art. ARX.15.SQ
Taglio a 45° o a 90° parti fisse
45° CUT or 90° for FIXED PARTS

MONTAGGIO CAVALLOTTO Art. ACX.47.SQ
STAND ASSEMBLY

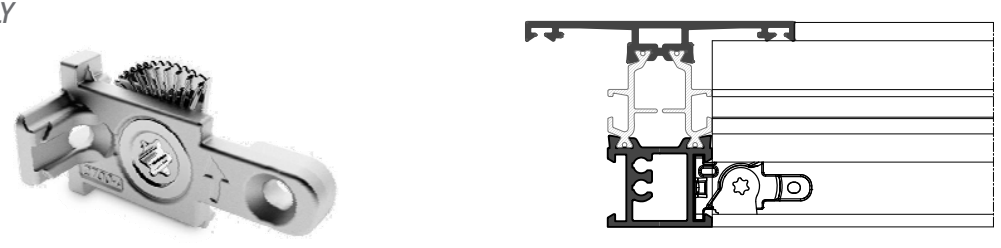

MONTAGGIO CAVALLOTTO Art. ARX.10.SQ
STAND ASSEMBLY

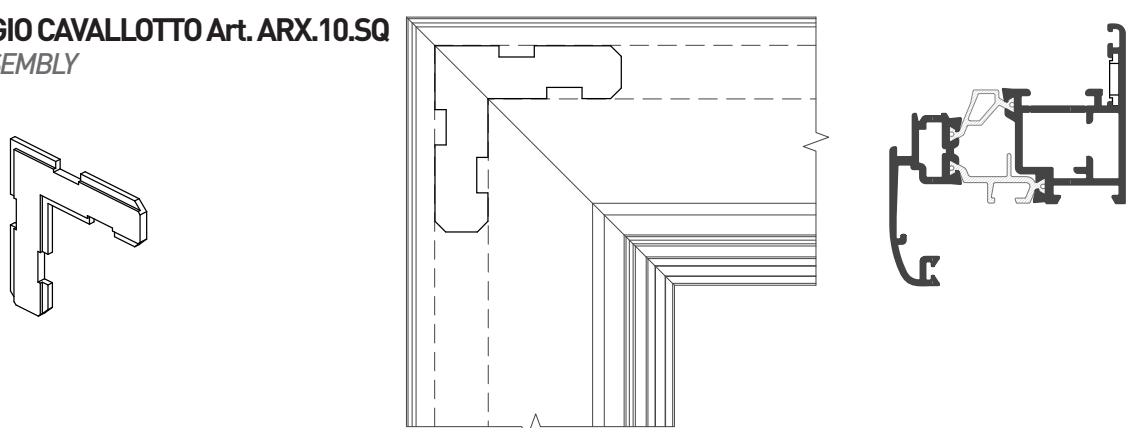

Applicazione Accessori

Accessories Application

ACX.63.SQ
CALALOTTO PER PROFILO CX55.103
T JOINT FOR CX55.103

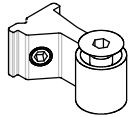

ACX.64.SQ
CALALOTTO PER PROFILO CX55.107
T JOINT FOR CX55.107

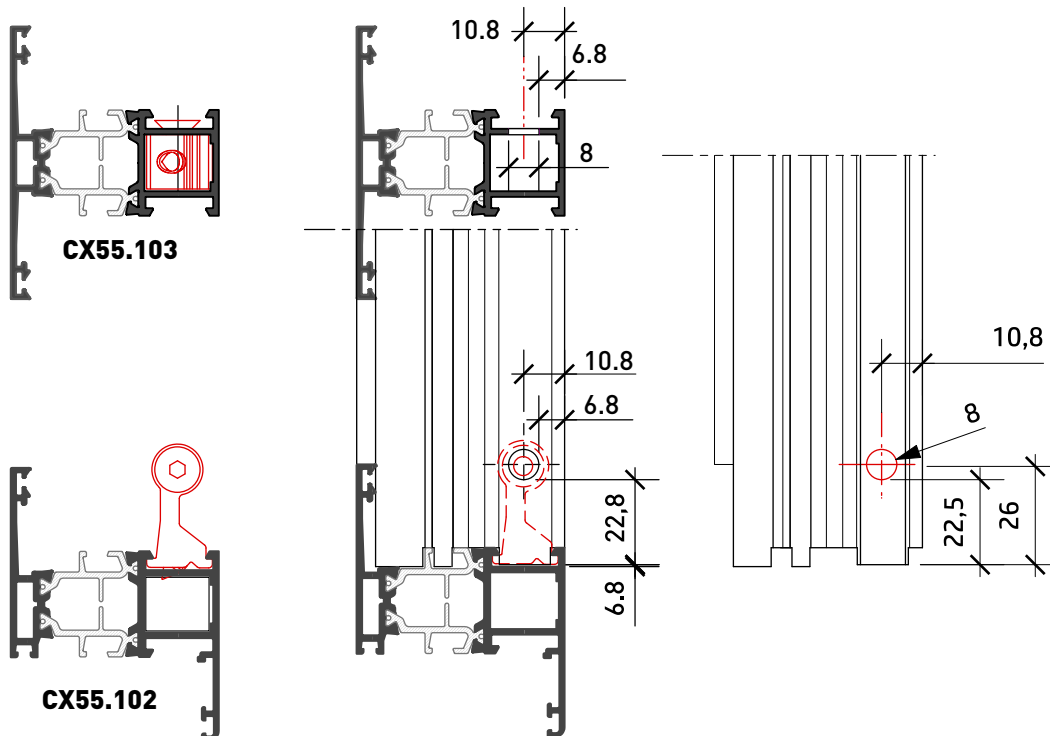
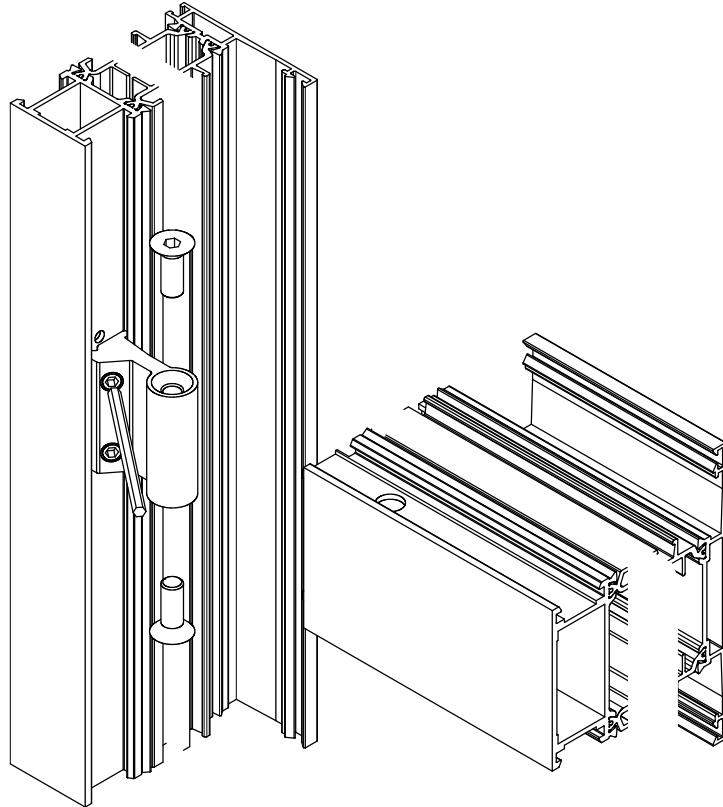
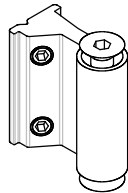

Applicazione Accessori

Accessories Application

ARX.11.SQ
MONTAGGIO SQUADRETTA
STAND ASSEMBLY

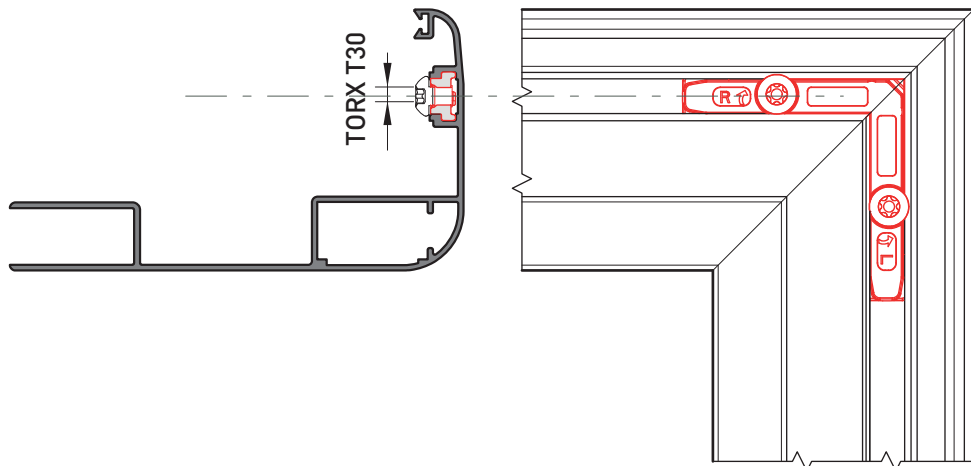
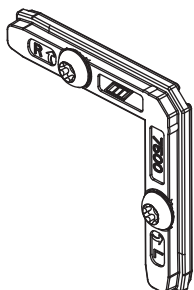

ACX 04.63
Clip per Profili XX70.503 | XX70.504
Clip for Profiles XX70.503 | XX70.504

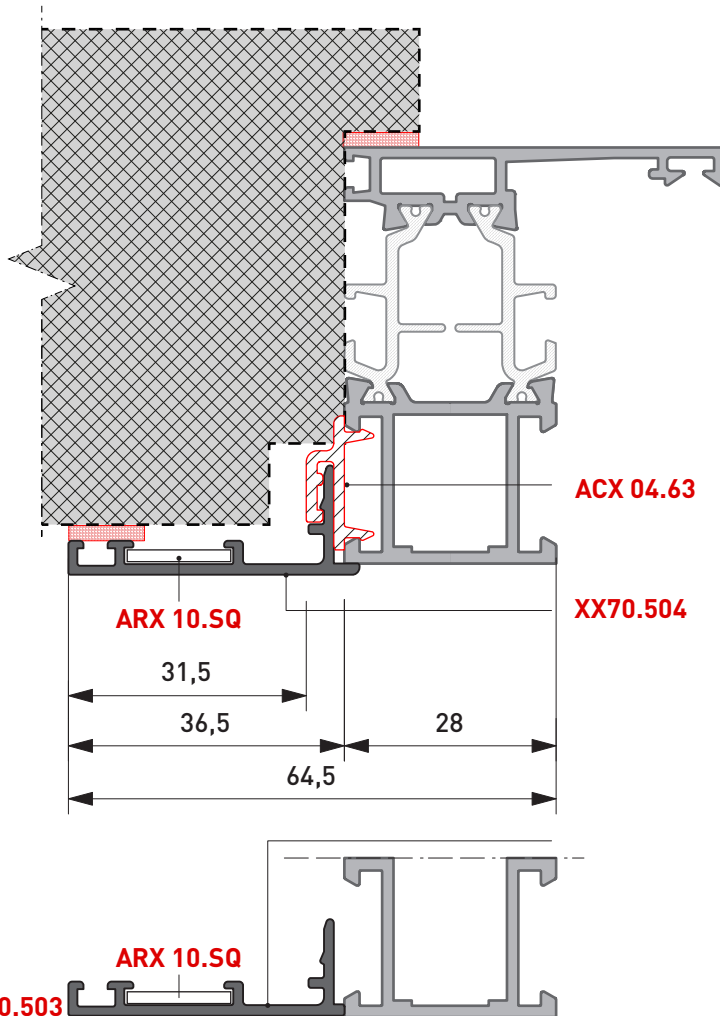
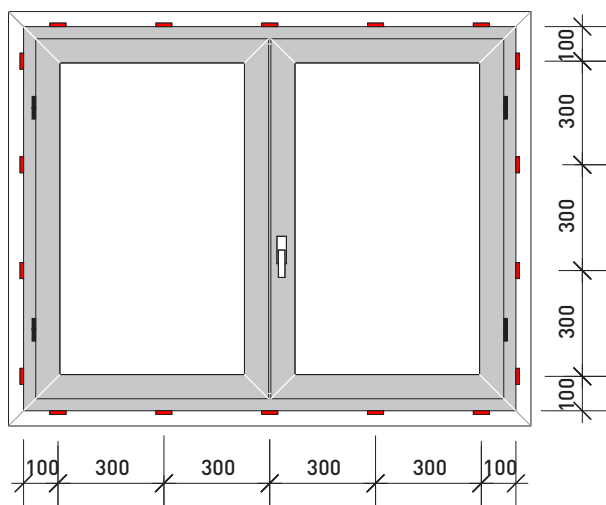
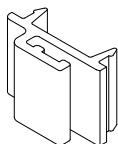

NB: Applicare le CLIPS secondo lo schema indicato quando possibile

NB: When possible, apply the CLIPS according to the present scheme,



Applicazione Accessori

Accessories Application

ACX.03.12
Terminale Asta
Bar Terminal

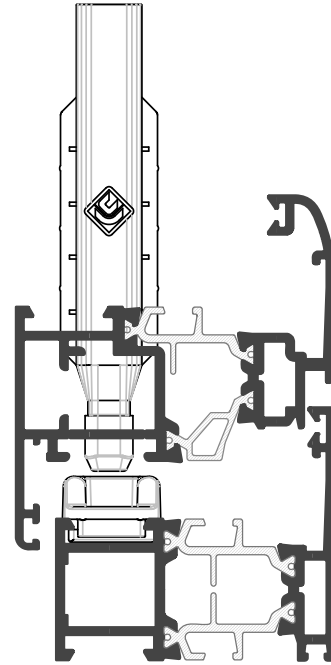
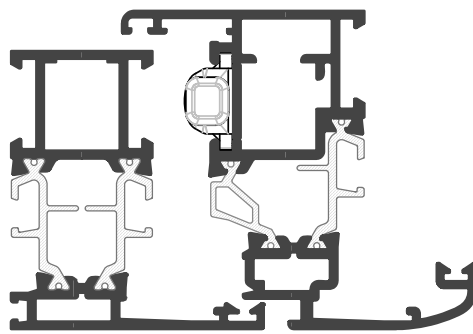
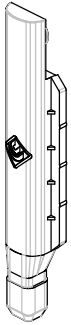

ACX.03.18
Terminale Asta in ZAMA
ZAMAC Bar Terminal

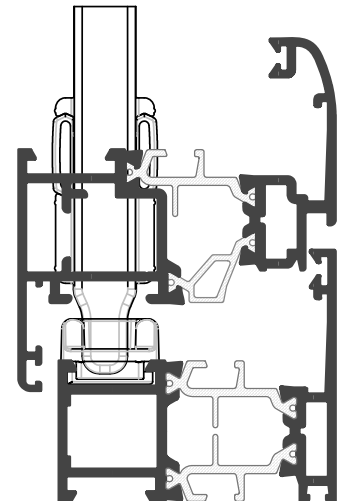
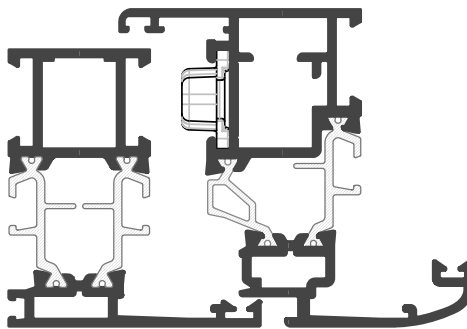
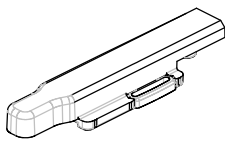

ACX.08.13
Incontro Asta singolo in ZAMA
Single Zamac Bar Rest Plate

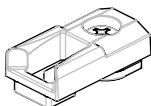



Applicazione Accessori

Accessories Application

ACX.03.11
Catenaccio a Leva
Lever Bolt

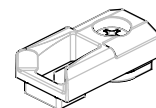
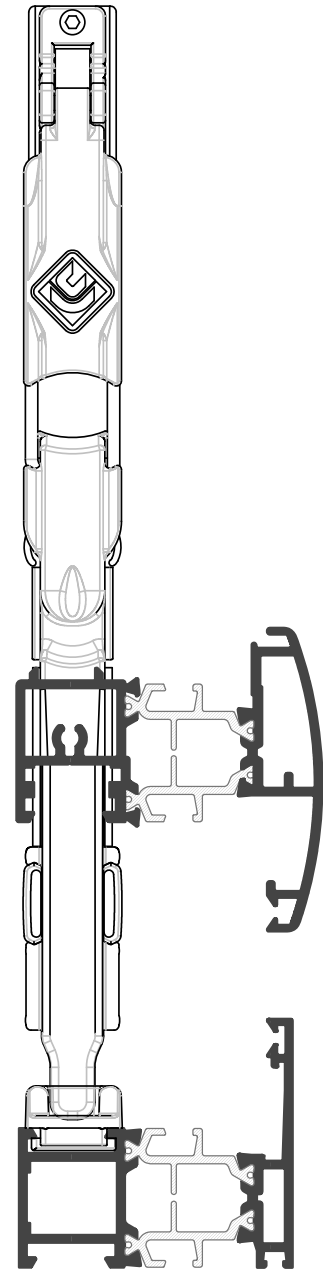
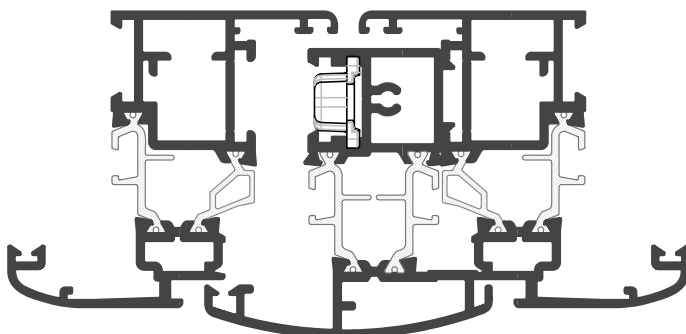
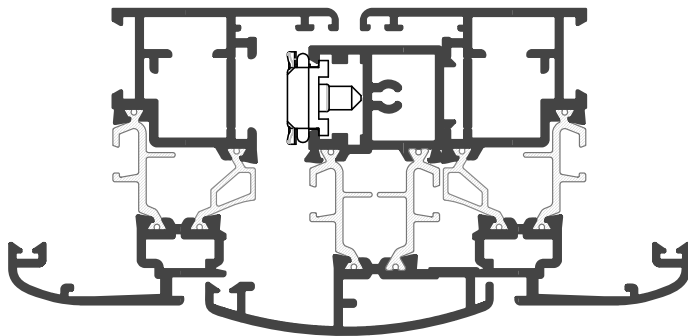
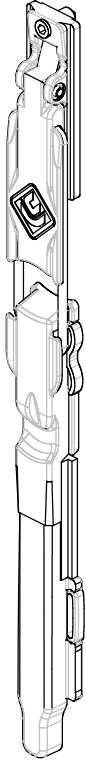

ACX.08.13
Incontro Asta
Bar Rest Plate



Applicazione Accessori

Accessories Application

ACX.03.16

**KIT di chiusura Supplementare
c/Eccentrico**

*Supplementary closure kit
with eccentric bolt*

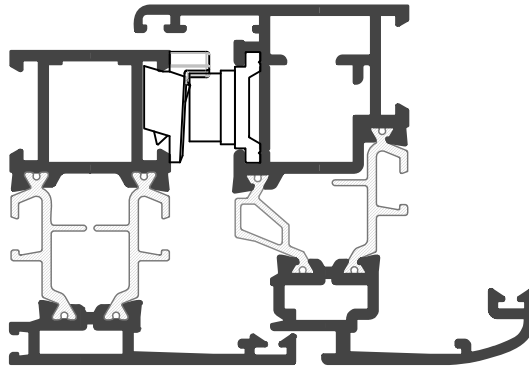
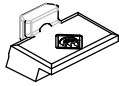

ACX.03.63

Incontro a pozzetto d = 8 mm

Drain rest plate D= 8 mm

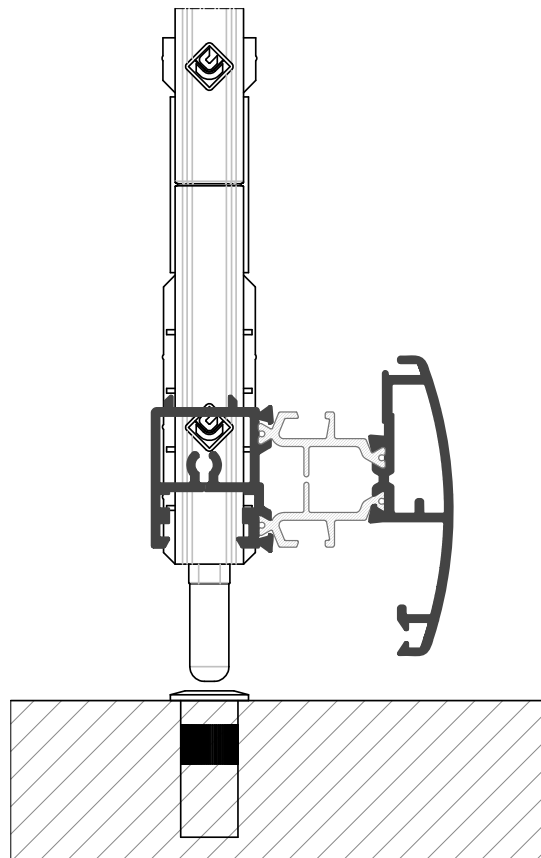
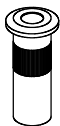



Applicazione Accessori

Accessories Application

ACX.03.19
Kit sostegno anta
Door support kit

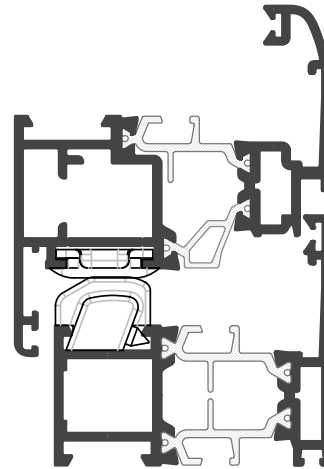
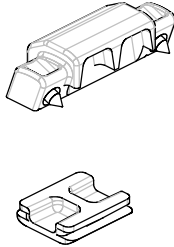

ACX.03.29
Rostro regolabile
Adjustable Bolt

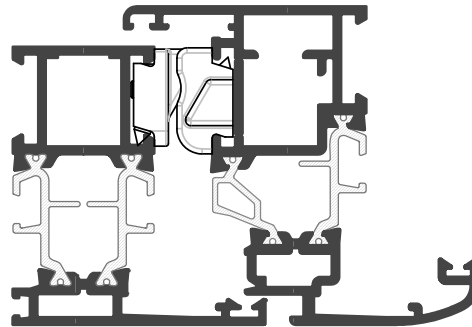
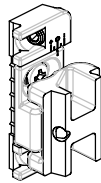

ACX.03.15
Clip ferma anta
Rabbit Clip

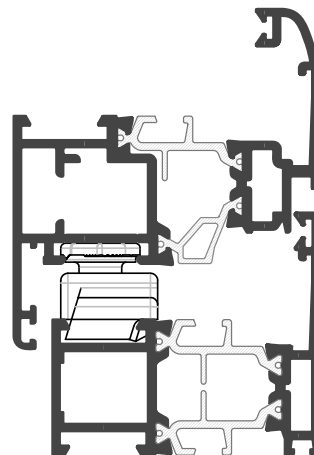
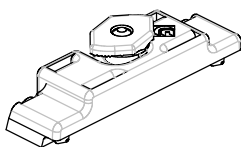

Applicazione Accessori

Accessories Application

ARX.05.01

Cappetta drenaggio
Drainage plug

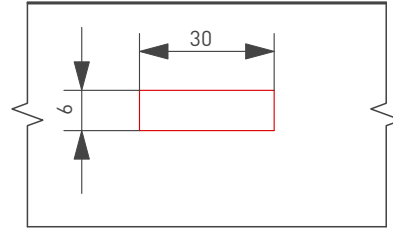
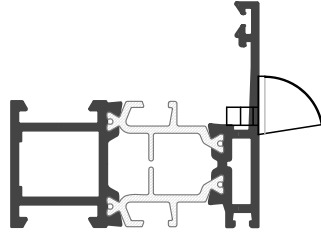
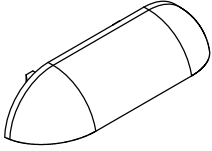

ARX.06.02

Piastrina registro Telaio
Frame adjustment plate

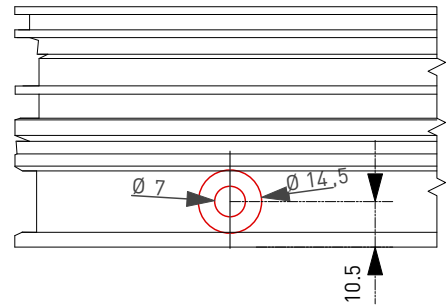
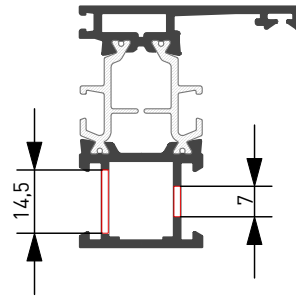
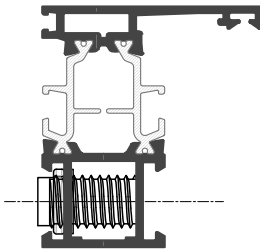
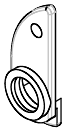

ARX.06.03

Registro Telaio 20 mm
Frame adjusting screw 20 mm

Applicazione Accessori

Accessories Application



ACX.07.02
Angolo fermavetro
Glazing bead corner

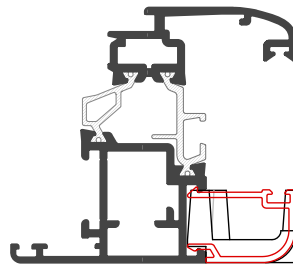
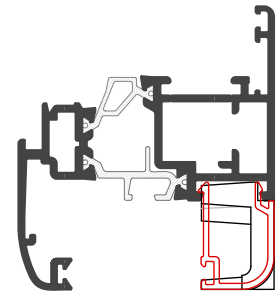
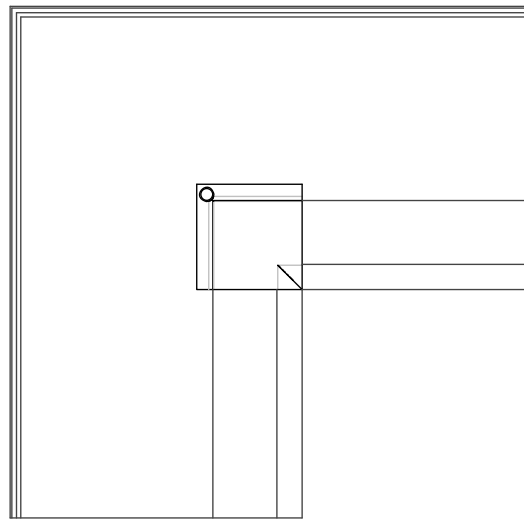

TAPPO PER PROFLO XX60.627 (Porta a 2 ante, anta semifissa)
PLUG FOR PROFILE (2 Sashes Door, Semi Fixed Sash)

PROFILI: **XX70.627**
PROFILES



Art. ARX.04.30

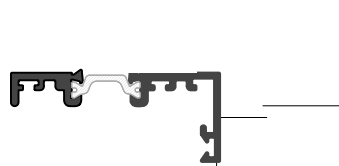

Art. ARX.04.31



Applicazione Accessori

Accessories Application

Coppia Tappi di Riporto camera Europea Tondo / Dritto con pre-taglio
Pair of round / straight European chamber wing plugs with pre-cutting

Art. ARX.04.51

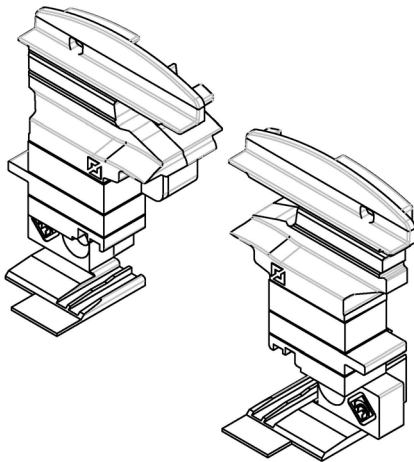

Art. ACX.04.51

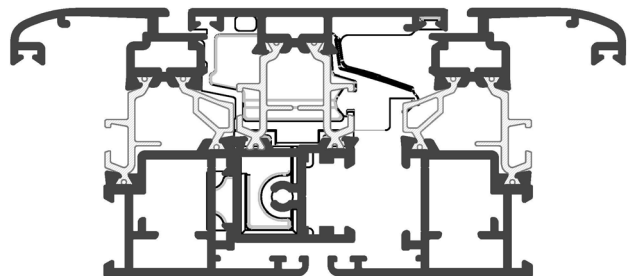
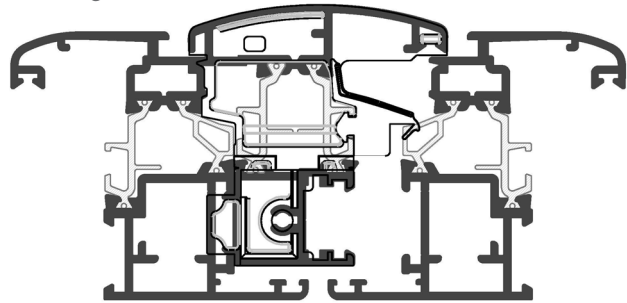

Coppia Tappi di Riporto Ferramenta a Nastro Tondo / Dritto con pre-taglio
Pair of round / straight tape hardware wing plugs with pre-cutting

Art. ARX.04.52

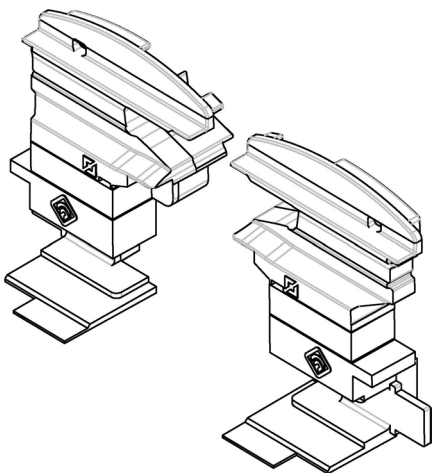

Art. ACX.04.52

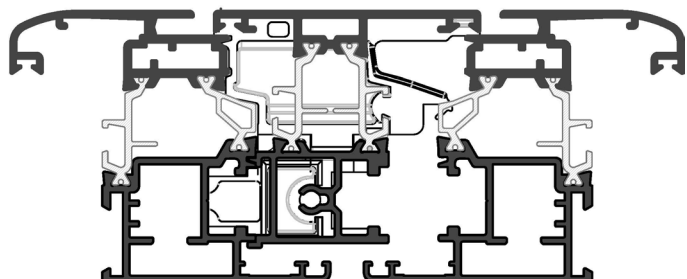
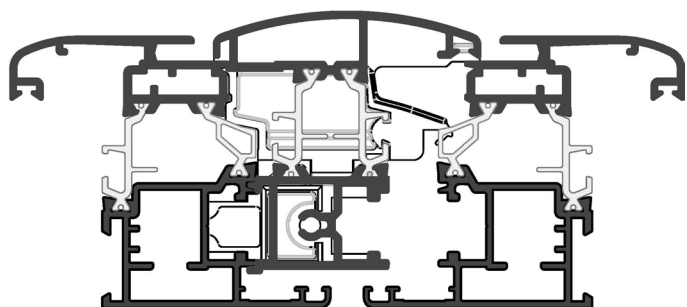

Applicazione Accessori

Accessories Application

Art. ARX.04.52

CX55.301 | CX55.301
Riporto Tondo | Riporto Tondo

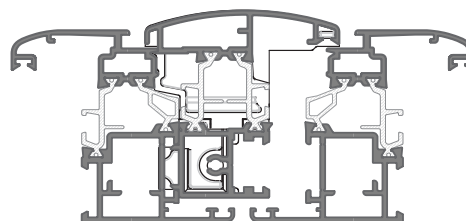
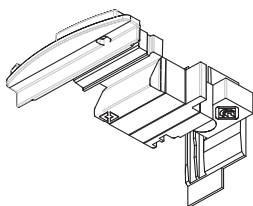

CX55.301 | CX55.301
Riporto Dritto [Porzione da Tagliare] | Riporto Dritto [Cutting Part]

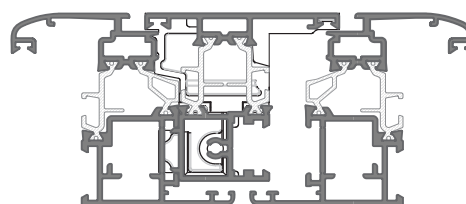
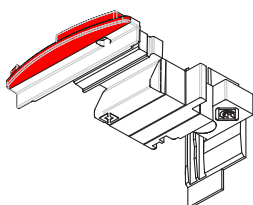

CX55.301+XX70.643 | CX55.301+XX70.643
Riporto Dritto | Riporto Dritto
Apertura Esterna [Porzione da Tagliare] | Apertura Esterna [Cutting Part]

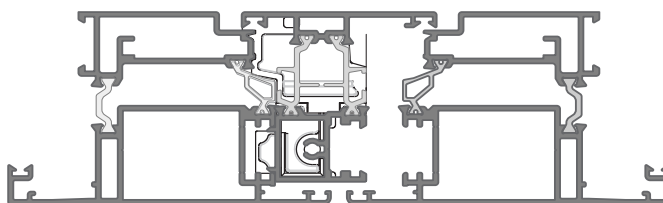
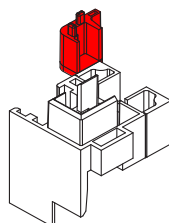

Kit Tappi di Riporto Doppia Battuta per XX70.643
Pair double sash door plugs for XX70.643

Art. ARX.04.60

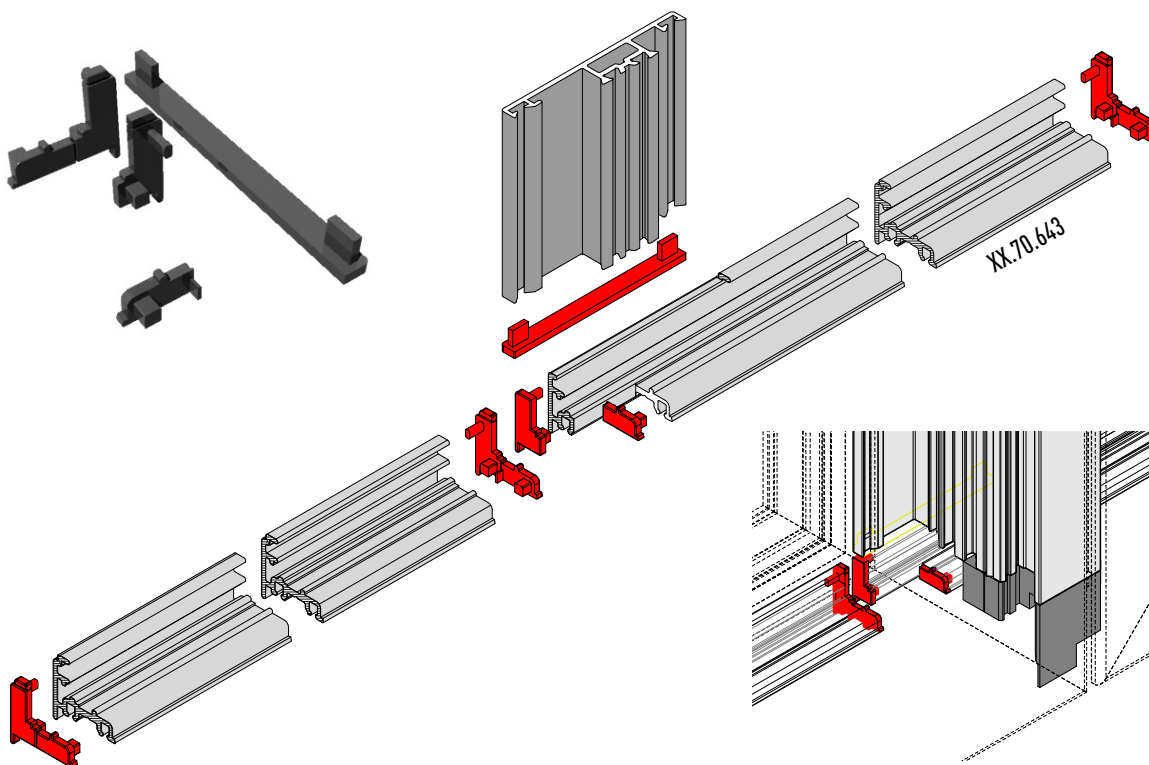



Applicazione Accessori

Accessories Application

Art. XX70.643

Profilo Porta Spazzolino per Anta Doppia Battuta. Apertura Esterna
Brush Holder Profile for Double Stop Sash. External Opening

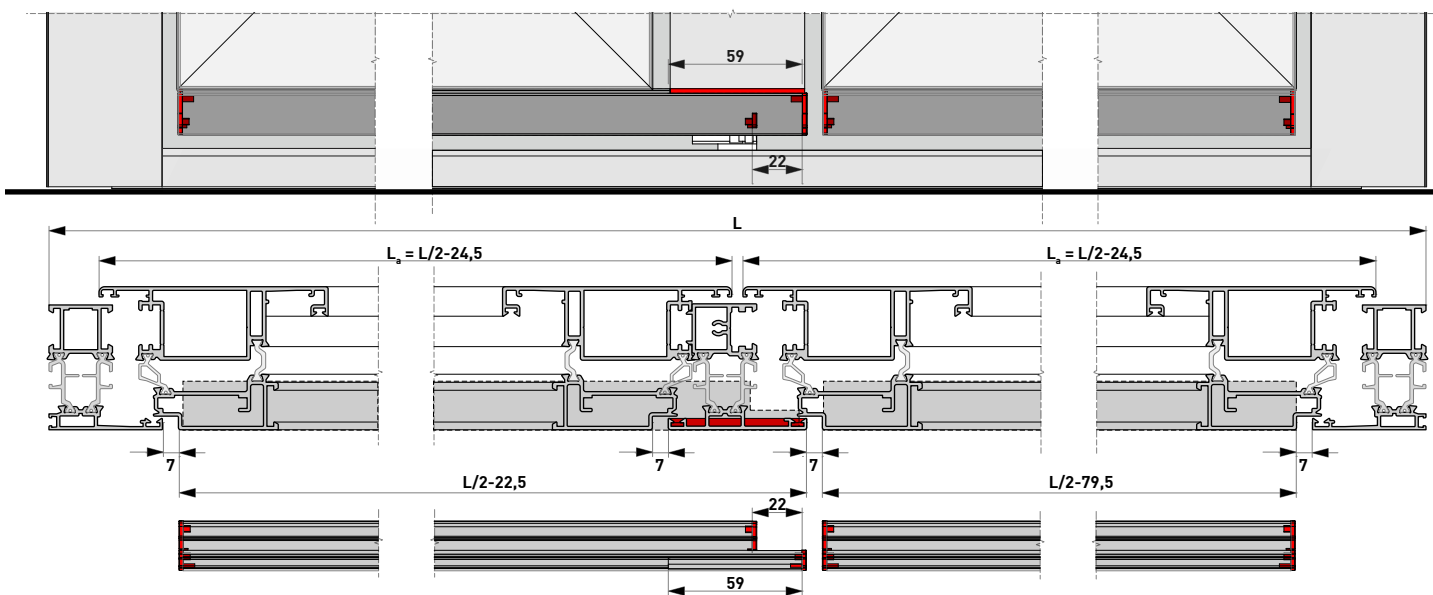
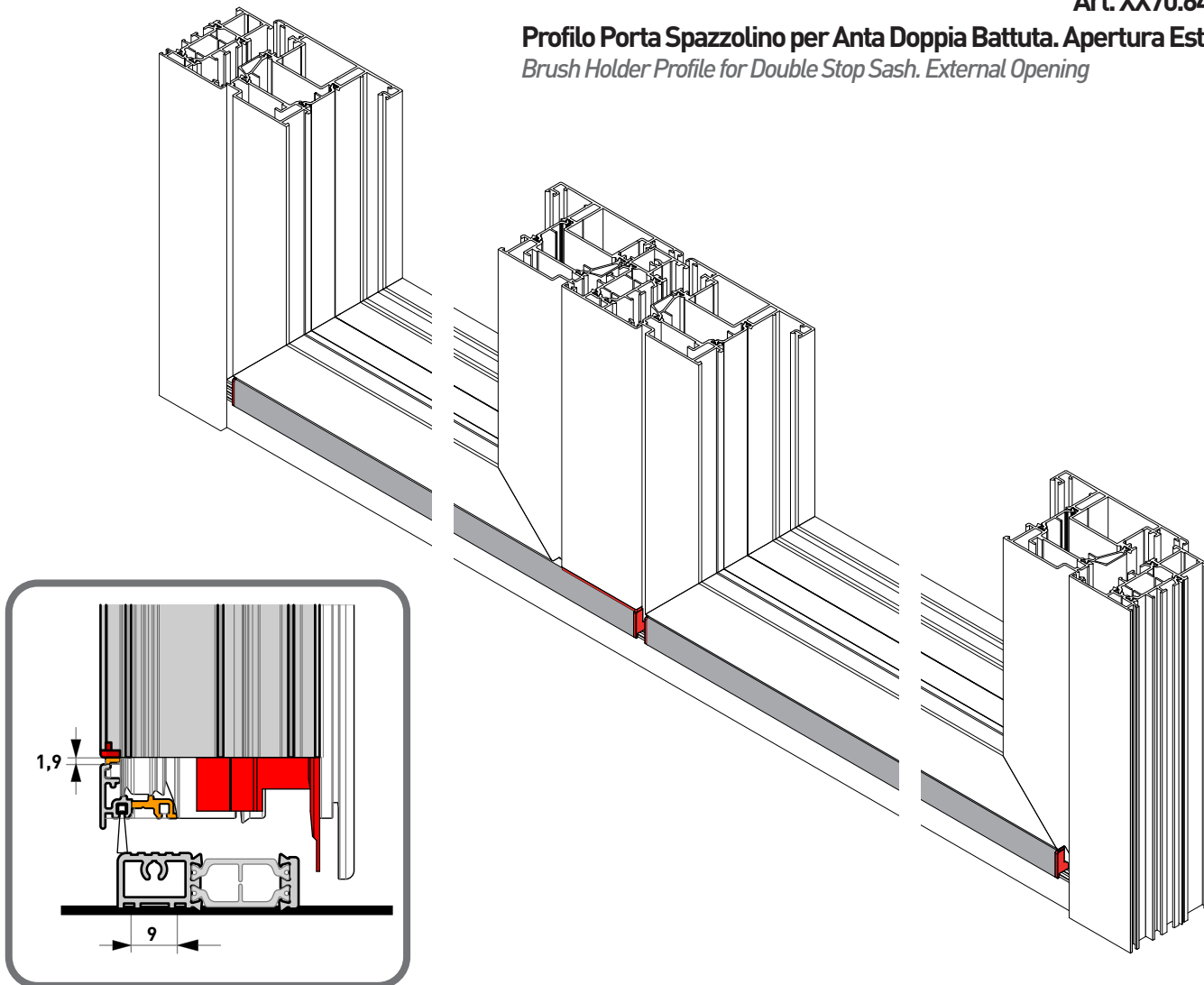

Applicazione Accessori

Accessories Application

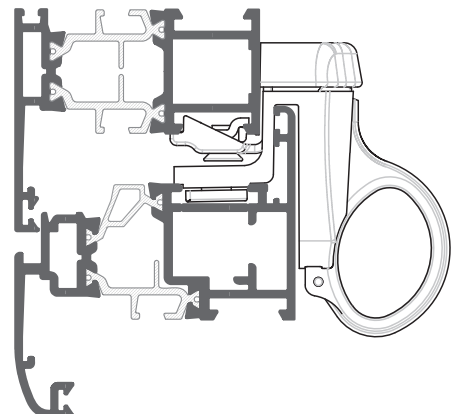
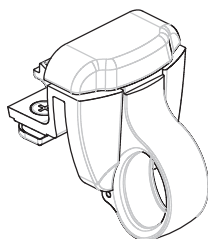
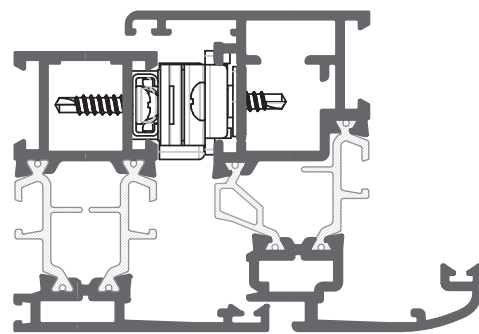
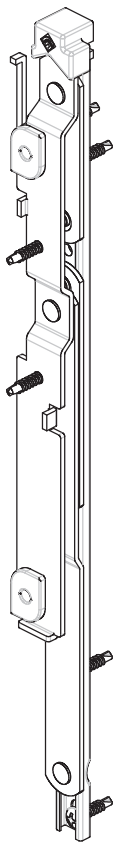
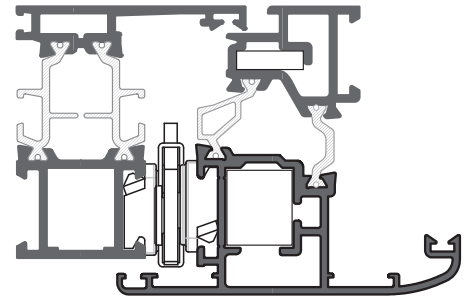
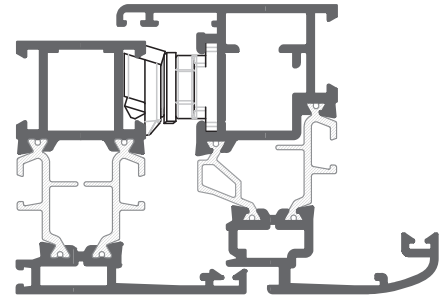
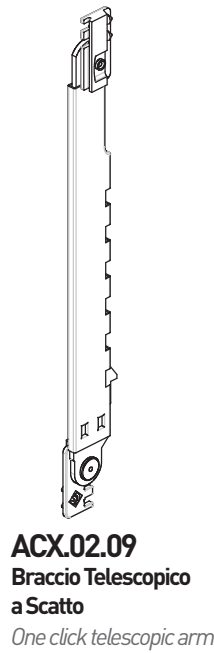
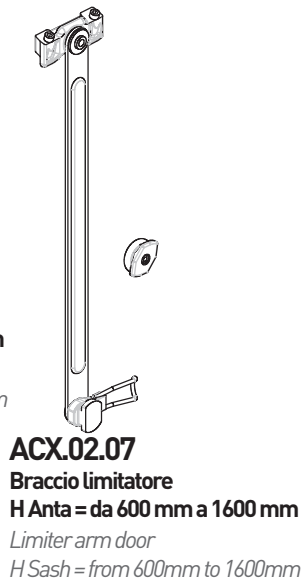



Applicazione Accessori

Accessories Application

ARX.03.02
Maniglia a Tavellino
Tavellino Handle

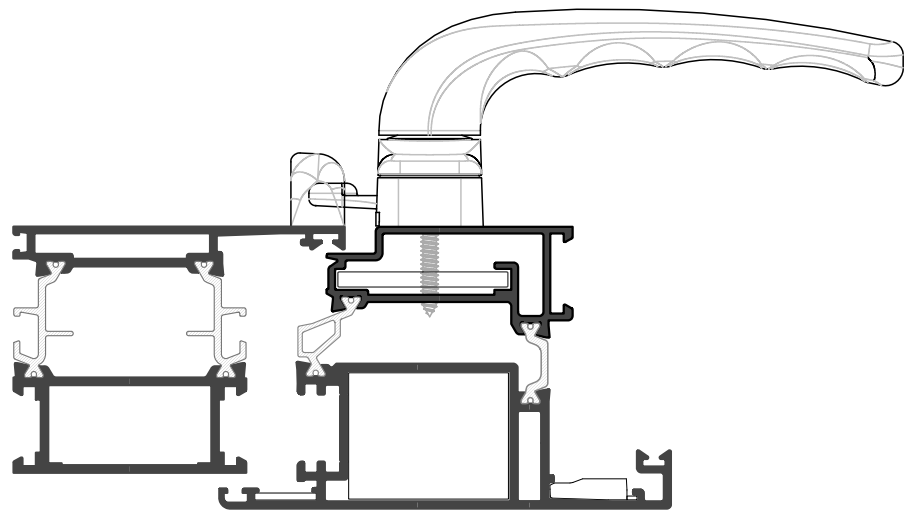
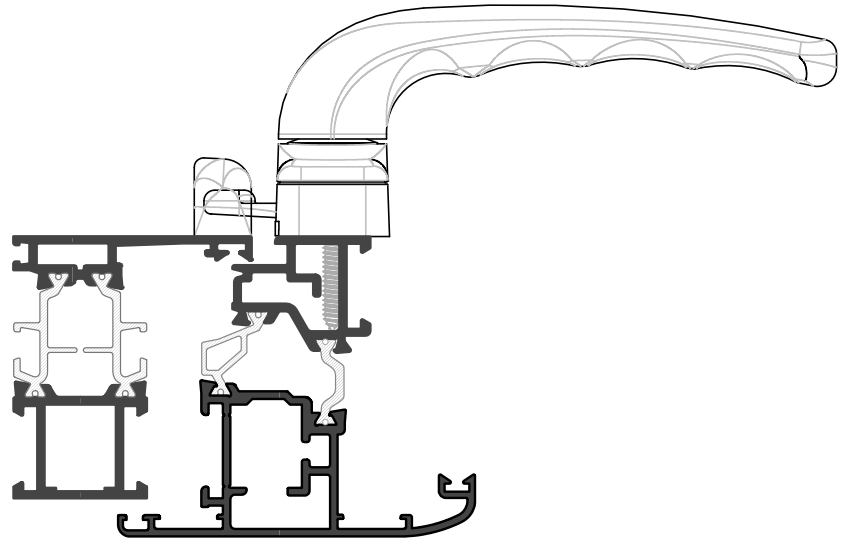
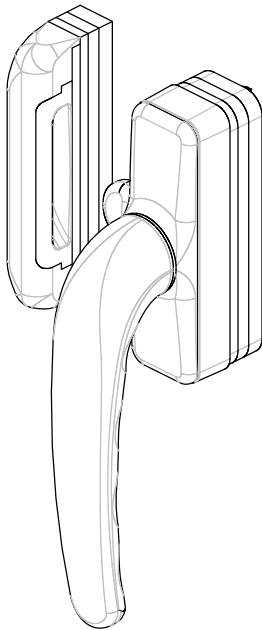

Applicazione Accessori

Accessories Application



ACX.03.73
"COMFORT MINI"
Martellina ridotta
Sporgenza quadro 70 mm
*Reduced Martellina handle
Square rosette projection
mm.70*

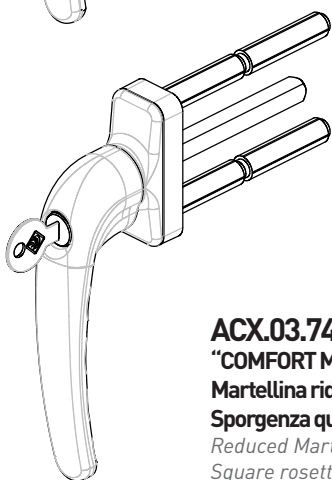
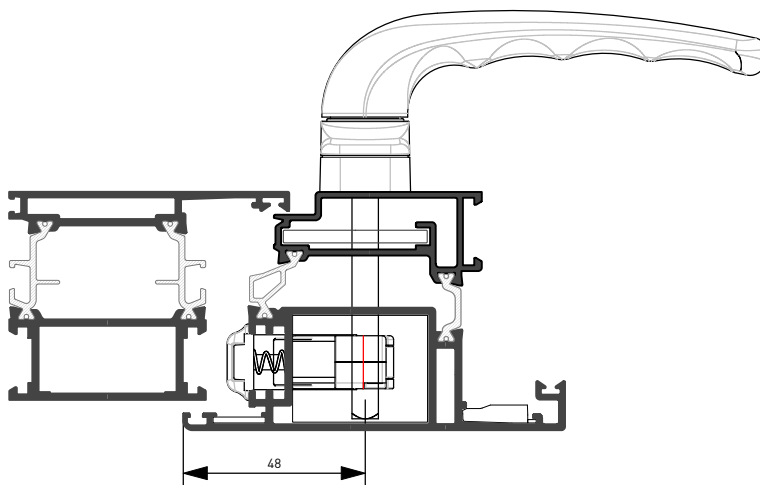

ACX.03.74
"COMFORT MINI"
Martellina ridotta con cilindro
Sporgenza quadro 70 mm
*Reduced Martellina handle
Square rosette projection
70 mm*

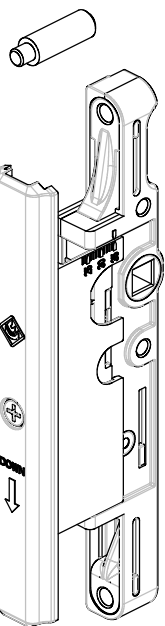
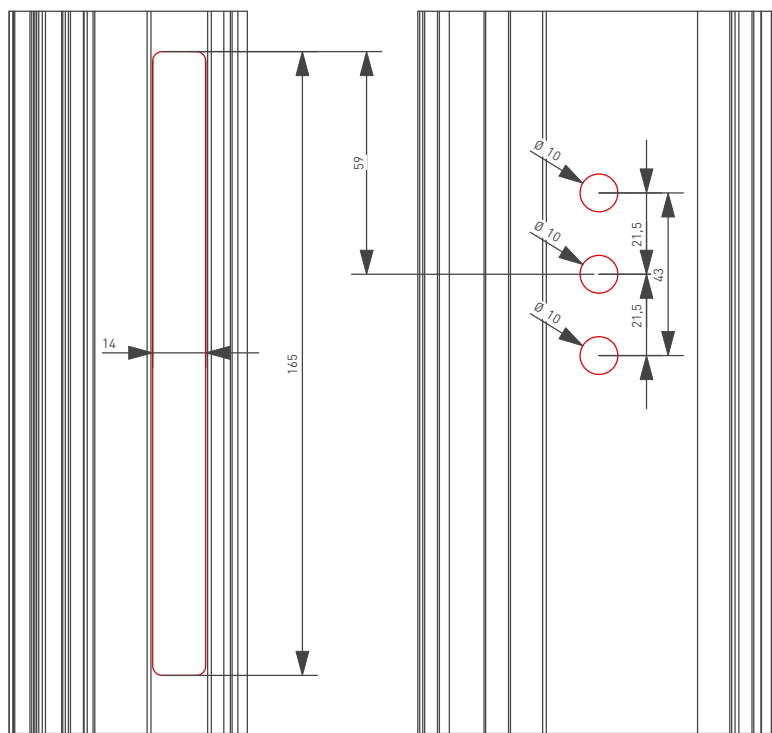

ARX.03.67
Perno di trascimento
L = 27 mm
Winding pivot n L = 27 mm

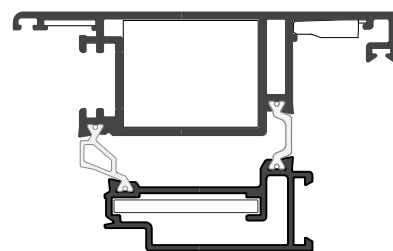
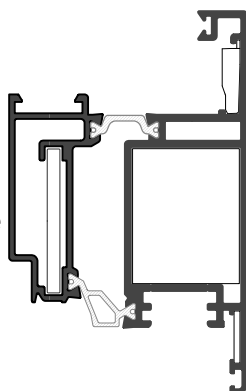

ACX.03.72
Movimentazione Bidirezionale
Interasse 23 - 35 mm
*Bi-directional movement
Center Distance 23 - 35 mm*

Applicazione Accessori

Accessories Application

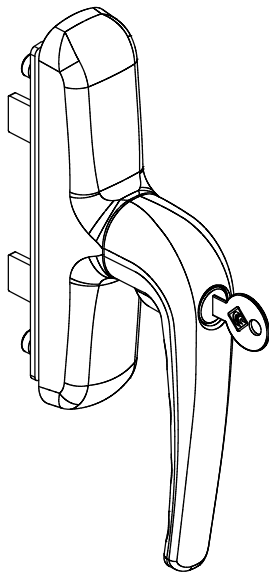

ARX.03.07
Cremonese con chiave
Interasse 84 - 92 - 104 mm
*Cremonese bolt opening external
- int. 84/92/104mm*

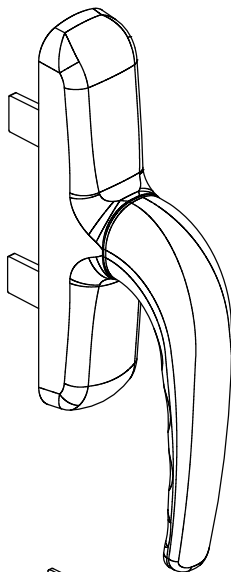
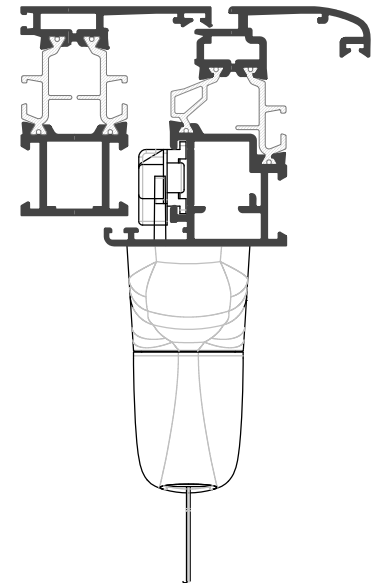
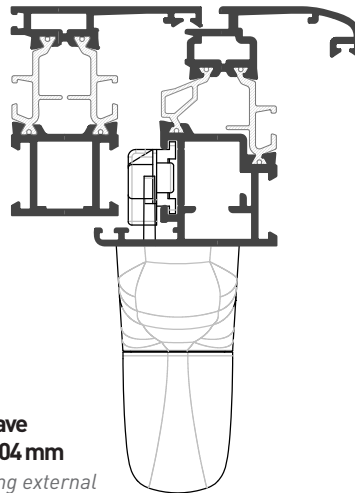

ARX.03.06
Cremonese
Interasse 84 - 92 - 104 mm
*Cremonese bolt with cylinder lock
external opening
- int. 84/92/104mm*

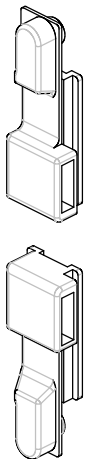
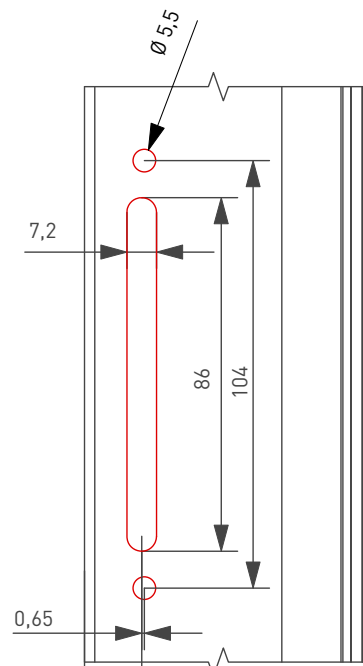

ACX.03.17
Innesti Cremonese
Winding pivot

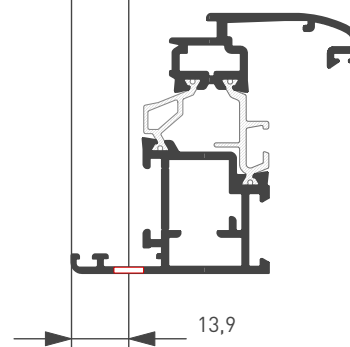

Applicazione Accessori

Accessories Application

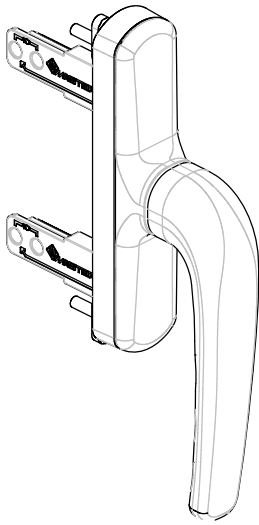

ARX.03.47
Cremonese Apertura
esterna - int. 28/65mm
Cremonese bolt external opening
- int. 28/65mm

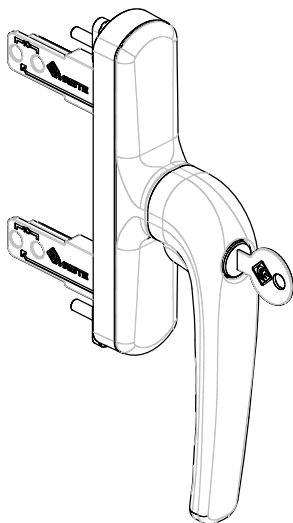

ARX.03.48
Cremonese Apertura esterna
con chiave - int. 38/65mm
Cremonese bolt external opening
with cylinder lock - int.
38/65mm

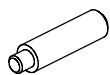

ACX.03.67
Perno di trascinamento
L=27mm
Winding pivot L=27mm

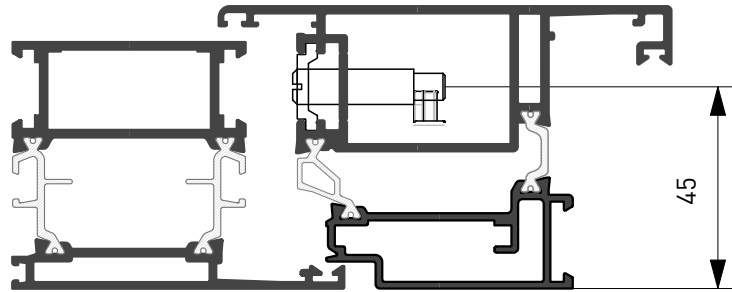

ACX.03.66
Perno L = 11 mm
Pivot L = 11 mm

ACX.03.67
Perno L = 27 mm
Pivot L = 27 mm

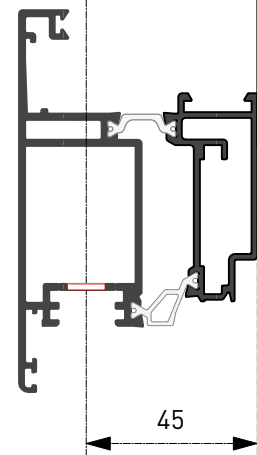
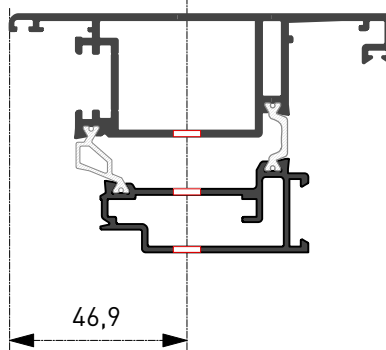
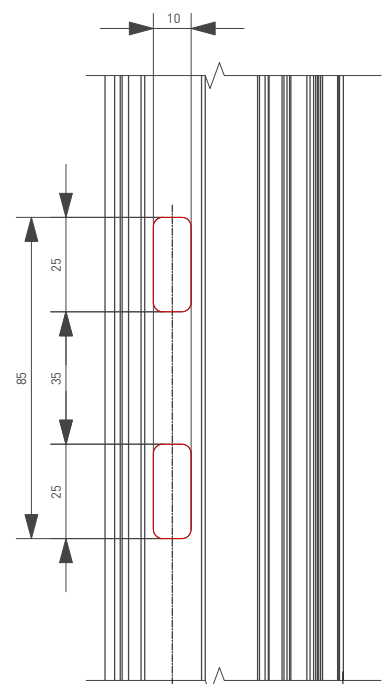
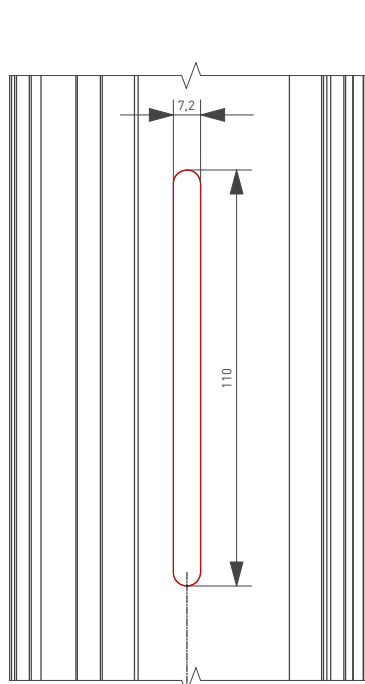

Applicazione Accessori

Accessories Application

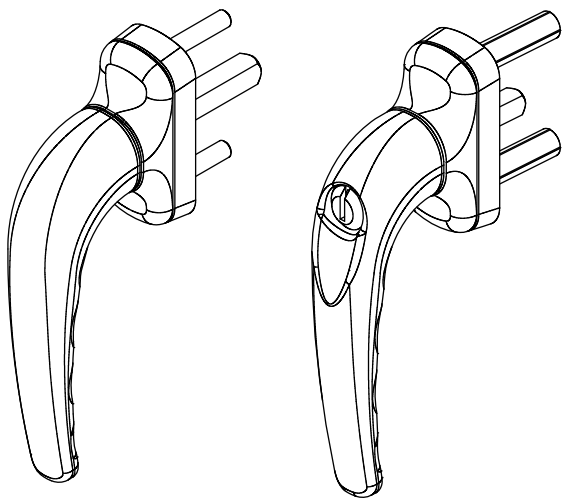

ARX.03.04
Martellina
Sporgenza quadro 24 mm
Martellina Handle Square
Rosette projection 24 mm

ARX.03.05
Martellina con chiave
Sporgenza quadro 24 mm
Martellina Handle with key
square rosette projection
24 mm

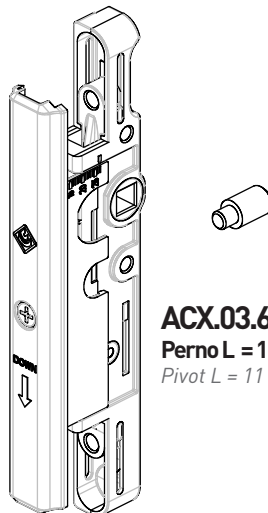

ACX.03.66
Perno L = 11 mm
Pivot L = 11 mm



ACX.03.67
Perno L = 27 mm
Pivot L = 27 mm

ARX.03.09
Movimentazione bidirezionale
regolabile 15 - 27 mm
Adjustable bidirectional
movement 15 - 27 mm

ACX.03.72
Movimentazione bidirezionale
regolabile 23 - 35 mm
Adjustable bidirectional
movement 23 - 35 mm

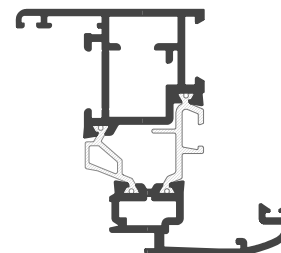
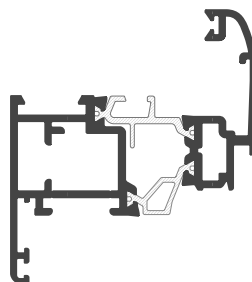
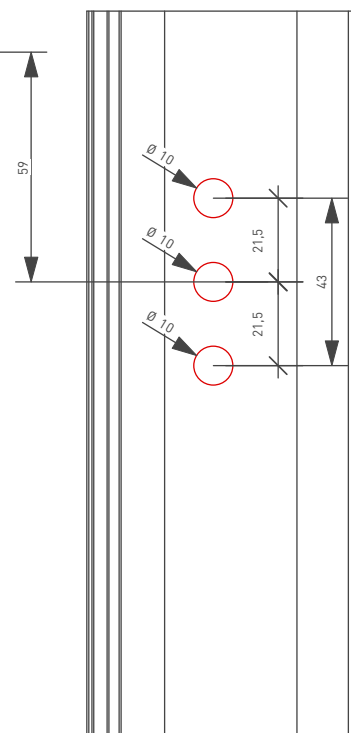
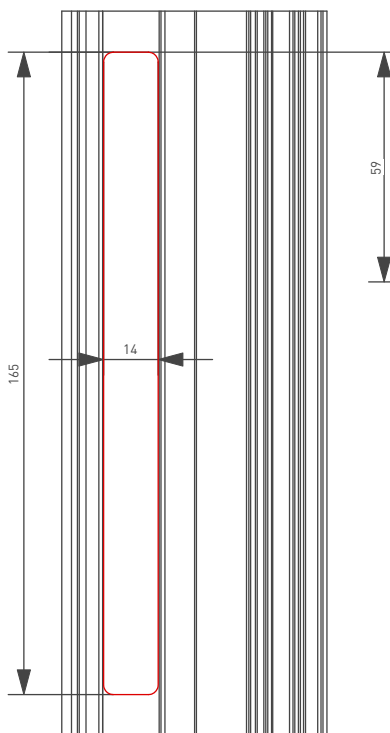
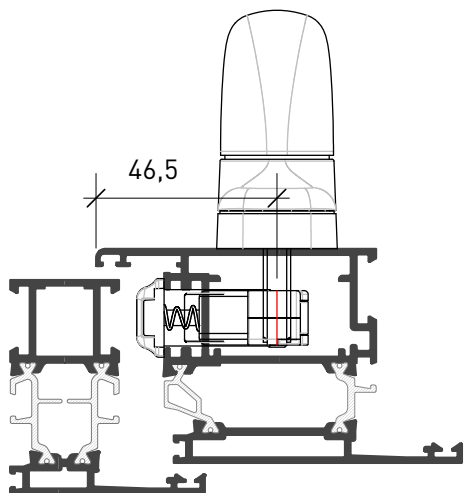
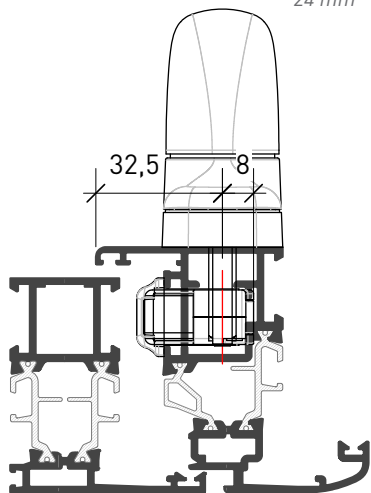

Applicazione Accessori

Accessories Application

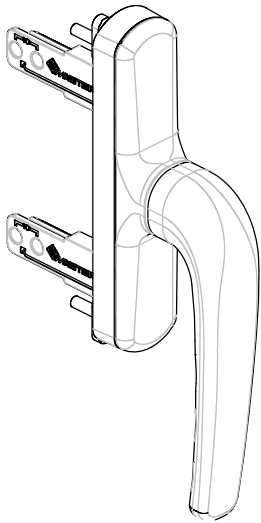

ARX.03.47
Cremonese Apertura
esterna - int. 28/65mm
*Cremonese bolt external opening
- int. 28/65mm*

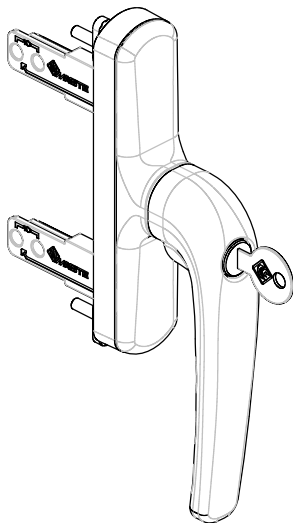

ARX.03.48
Cremonese Apertura esterna
con chiave - int. 38/65mm
*Cremonese bolt external opening
with cylinder lock - int.
38/65mm*

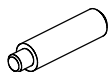

ARX.03.45
Perno di trascinamento
L=22 mm
Winding pivot L=22 mm

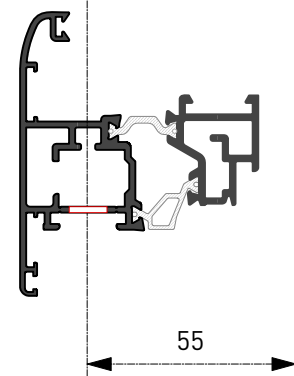
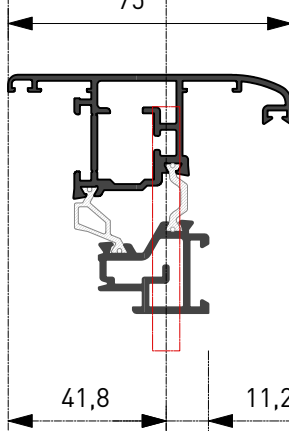
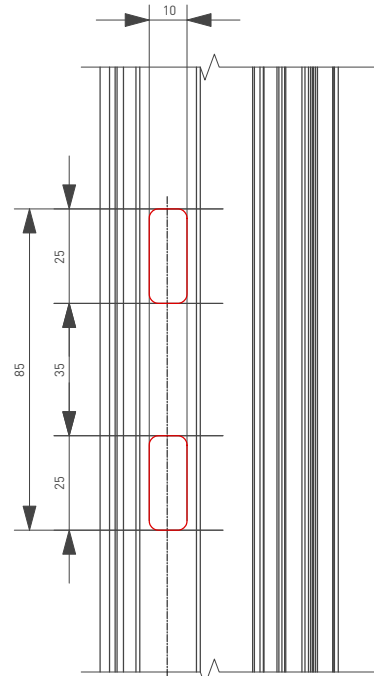
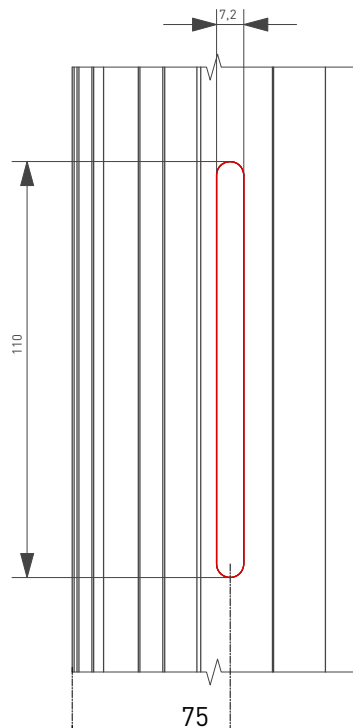
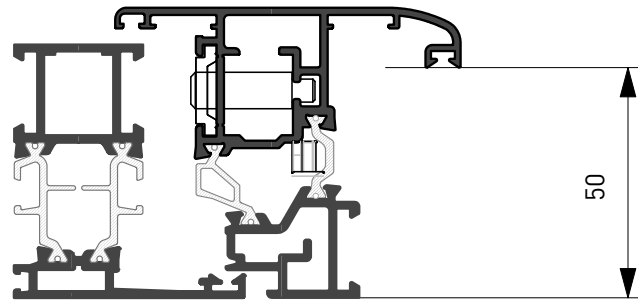

Applicazione Accessori

Accessories Application

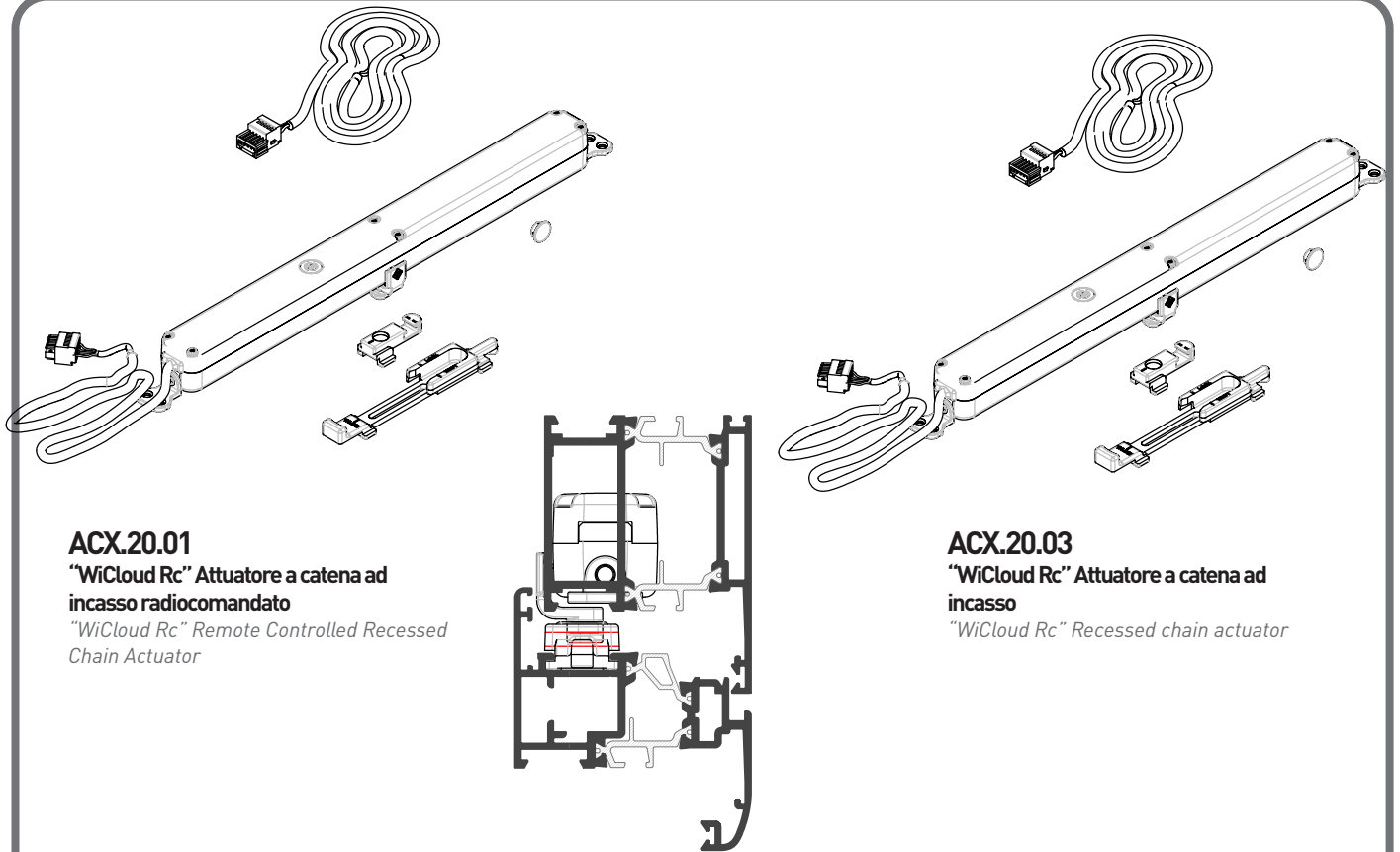

ACX.20.01
"WiCloud Rc" Attuatore a catena ad
incasso radiocomandato
"WiCloud Rc" Remote Controlled Recessed
Chain Actuator

ACX.20.03
"WiCloud Rc" Attuatore a catena ad
incasso
"WiCloud Rc" Recessed chain actuator

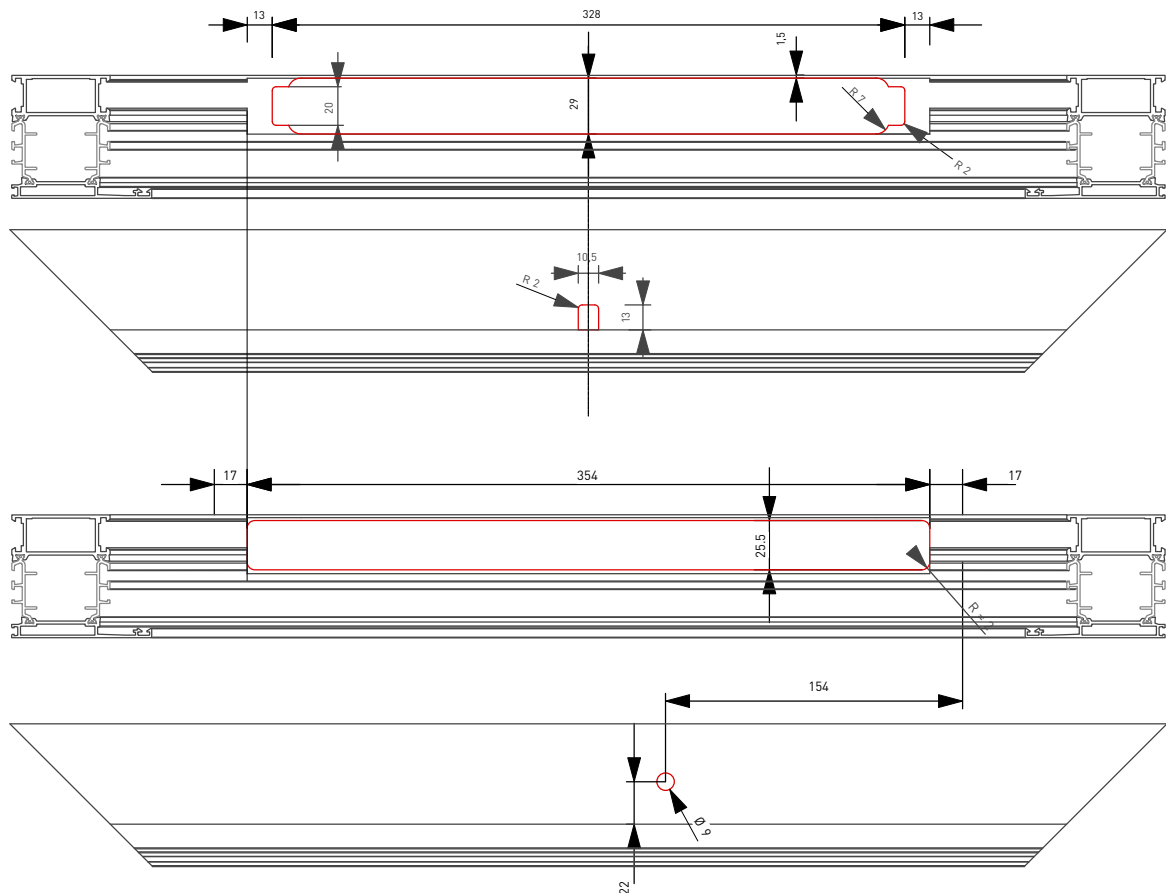

NB. Maggiori idettagli di montaggio nella confezione
N.B. More details about assembly in the package

Applicazione Accessori

Accessories Application

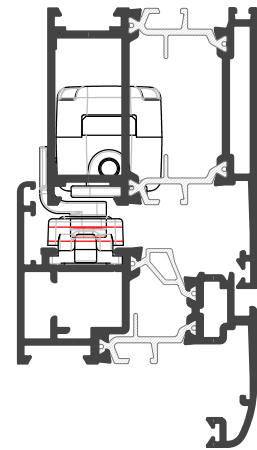
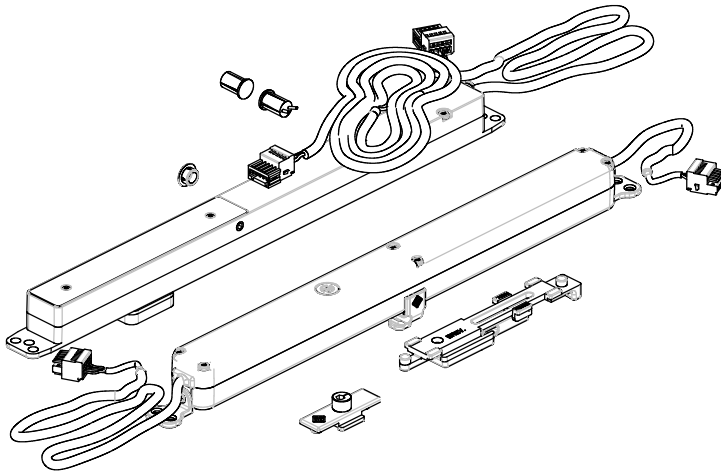

ACX.20.04

"WiCloud Rc - Lock"

Attuatore a catena radiocomandato + serratura elettromeccanica

"WiCloud Rc - Lock"

Remote controlled chain actuator + electromechanical lock

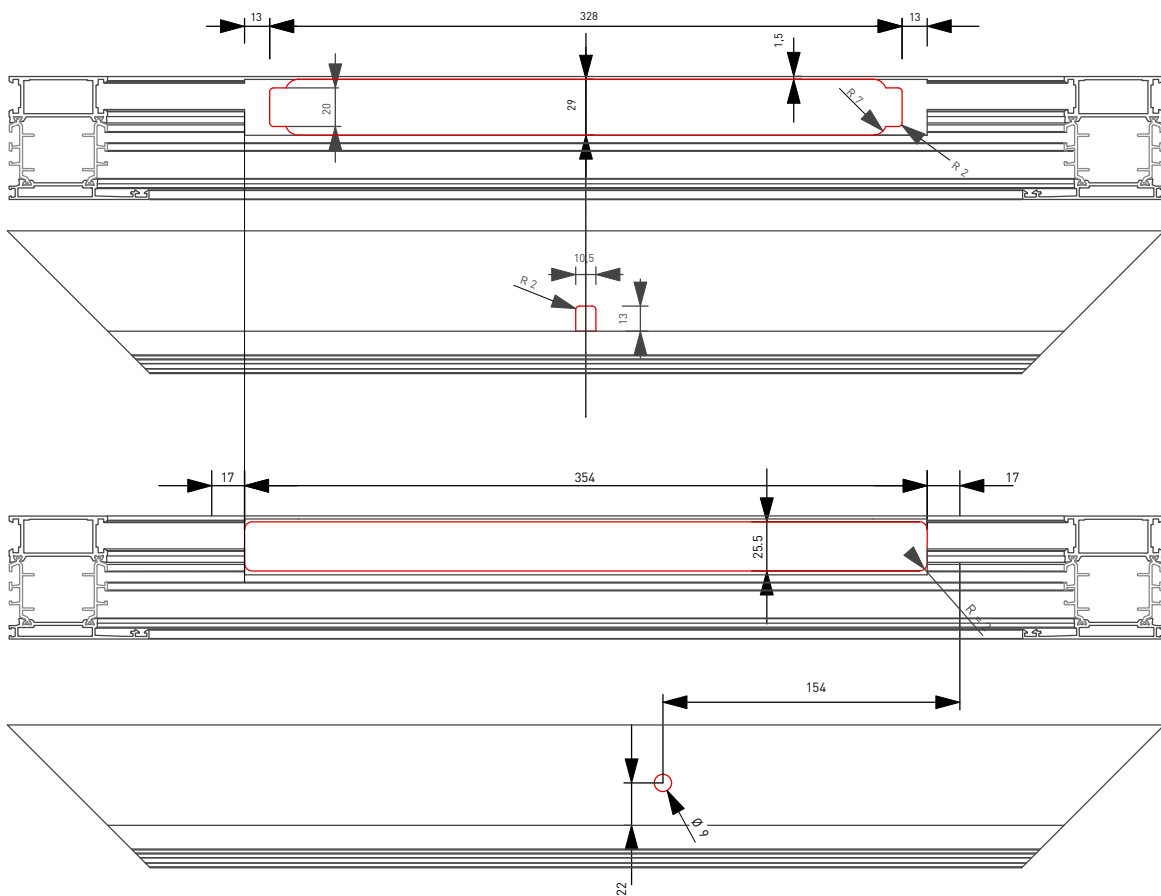

NB. Maggiori idettagli di montaggio nella confezione

N.B. More details about assembly in the package

GRUPPI FRESE
MILLING UNITS



GRFW27CAS3553

Gruppo Frese CX550/650
Traversi/telaio-ante e FN

Crosspiece/door frame milling unit
CX550/650 TAPE HW

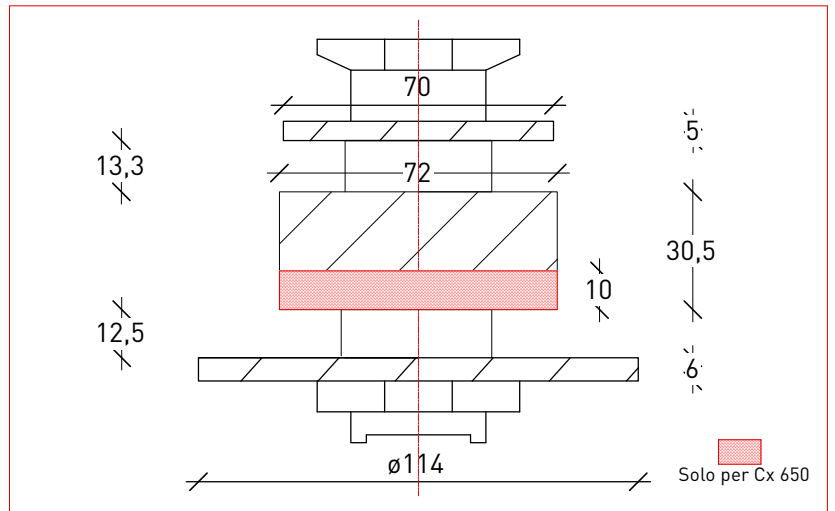

GRFW28CAS3553

Gruppo Frese ante complanari
Incluso distanziali per trasformarla in
Gruppo Frese ante ferramenta a nastro
Gruppo Frese trav/telaio-ante

Milling unit for coplanar sashes
spacer included for TAPE HW transformation.
Crosspiece/door frame milling unit.

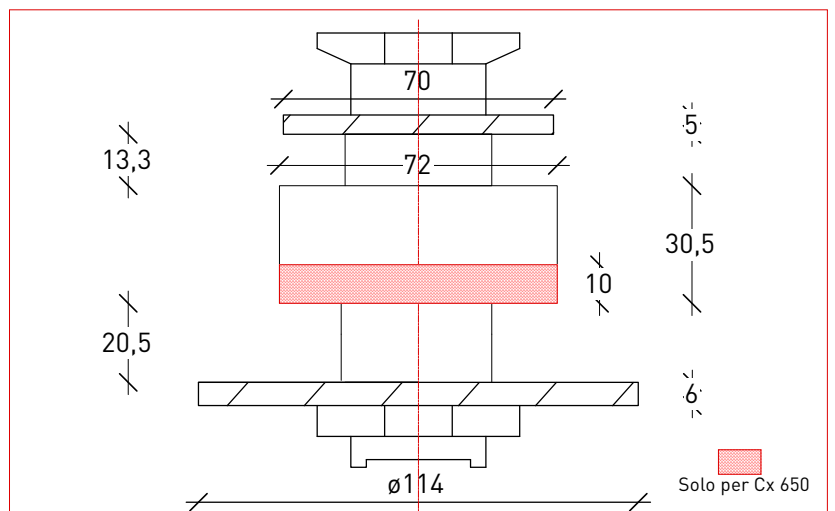

GRFW29CAS3553

Gruppo Frese CX550/650
Ferramenta a nastro

Milling unit CX550/650 TAPE HW

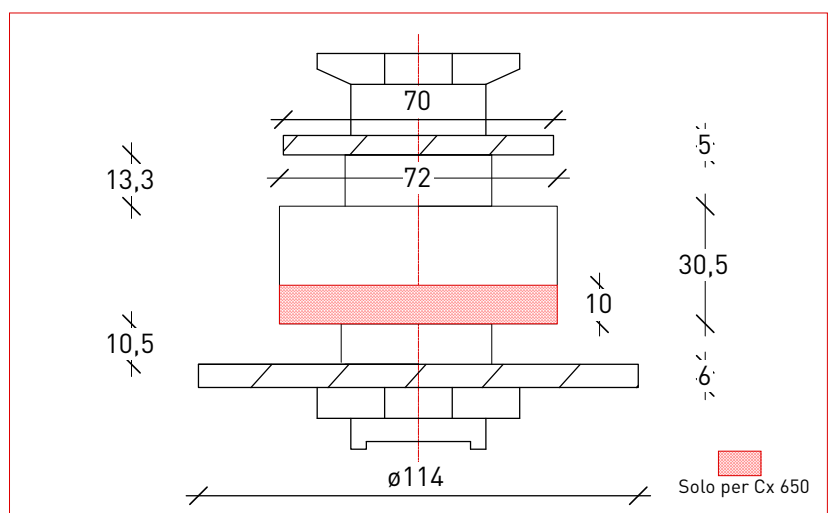



GRUPPI FRESE
MILLING UNITS



GRFW30CAS3553

Gruppo Frese CX550/650

Ante aperture esterne

Milling unit CX550/650 TAPE HW for EXT

Opening Sashes

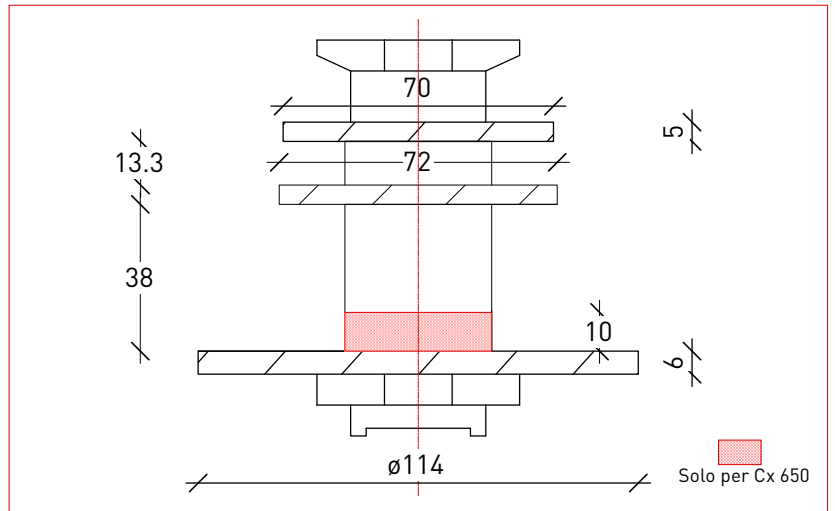

GRFW31CAS3553

Gruppo Frese CX550/650

Ante vetro infilare

Milling unit CX550/650 for insert glass

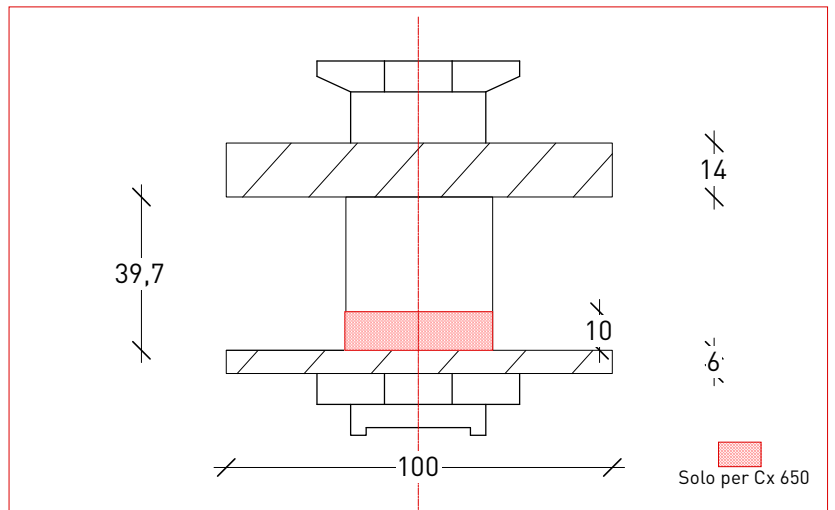



Applicazione Accessori

Accessories Application

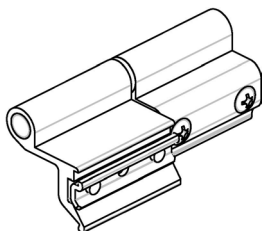

ACX.02.01
Cerniera a montaggio rapido a 2 ali
Rapid assembly 2-leafed hinge

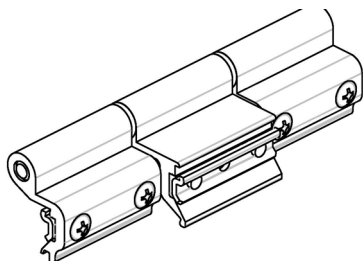

ACX.02.03
Cerniera a montaggio rapido a 3 ali
Rapid assembly 3-leafed hinge

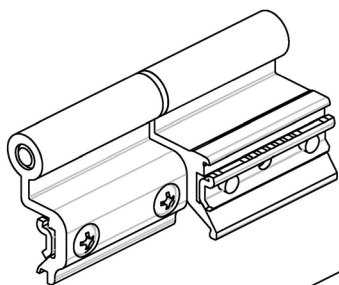
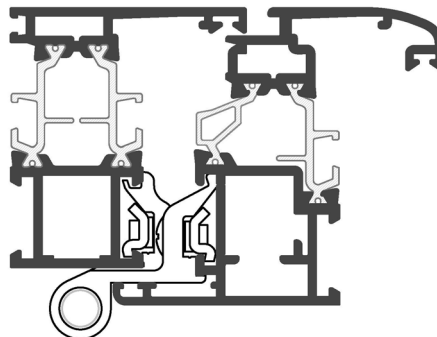

ACX.02.02
Cerniera a montaggio rapido a 2 ali
Rapid assembly 2-leafed hinge

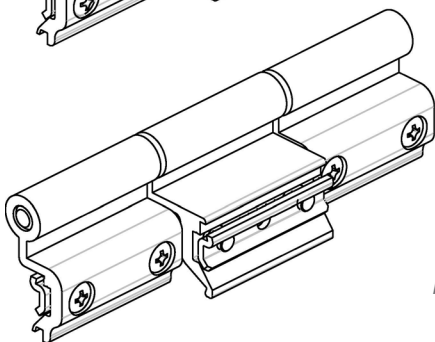

ACX.02.04
Cerniera a montaggio rapido a 3 ali
Rapid assembly 3-leafed hinge

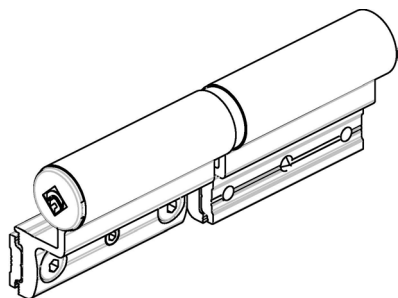
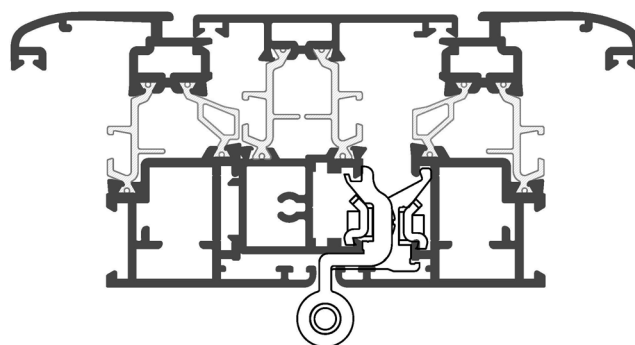

ACX.02.11
Cerniera porte a 2 ali
Rapid assembly 2-leafed hinge

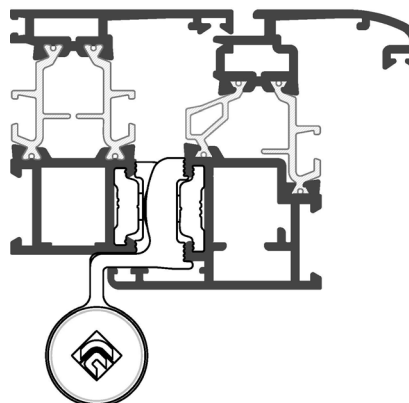

Applicazione Accessori

Accessories Application

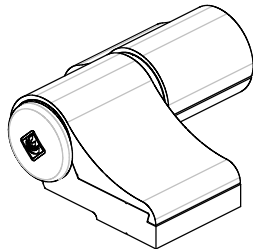
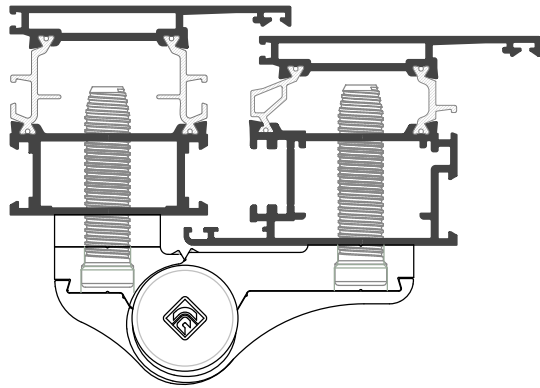

ARX.02.12

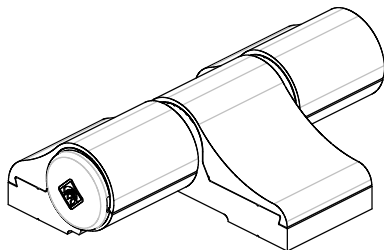

ARX.02.13

ARX.02.36

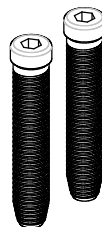

ARX.02.25

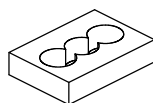

**Lavorazione per
cerniera 2 ali**
Tooling for 2-leaved hinge

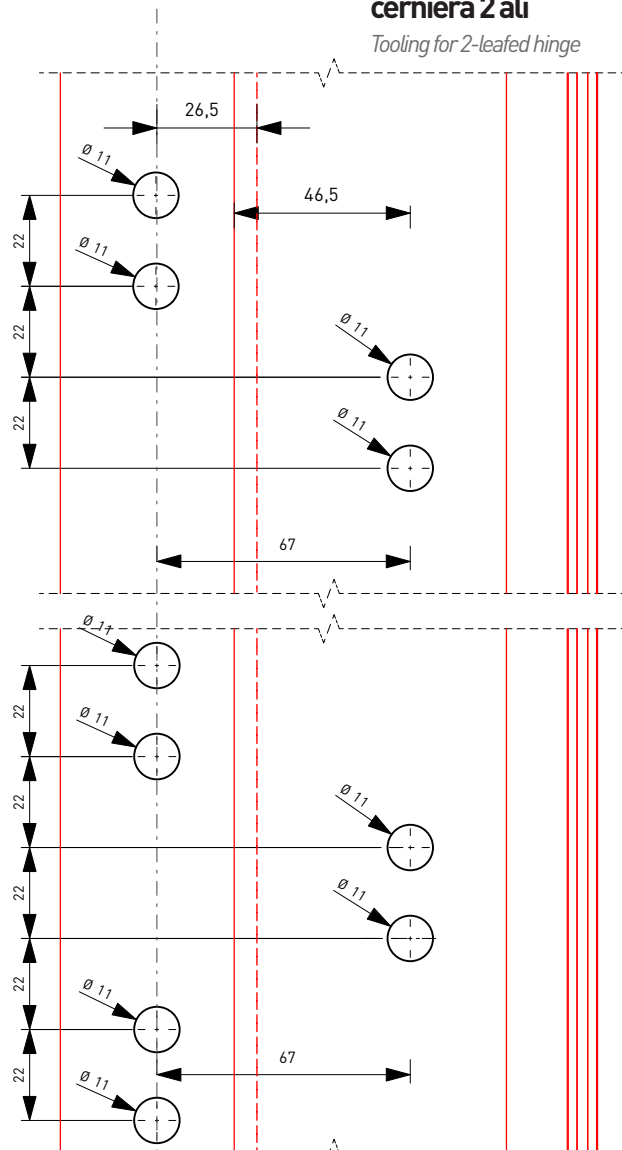

**Lavorazione per
cerniera 3 ali**
Tooling for 3-leaved hinge

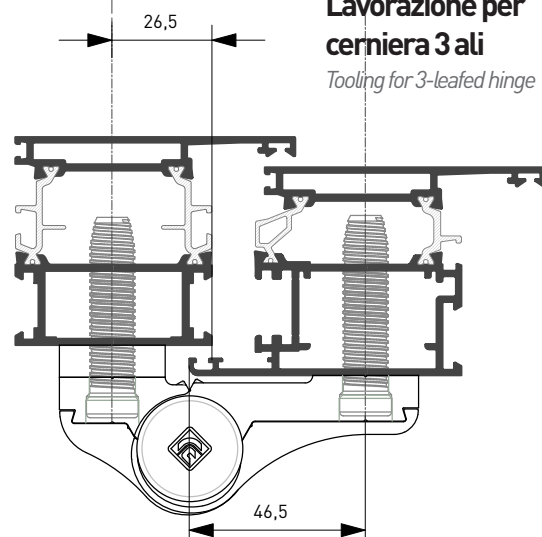



Applicazione Accessori

Accessories Application

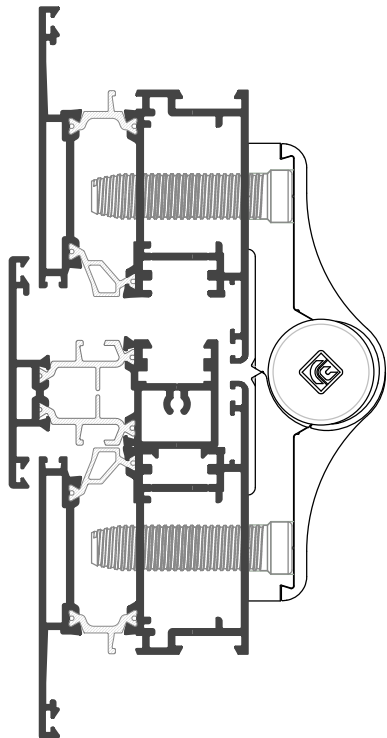

ARX.02.33

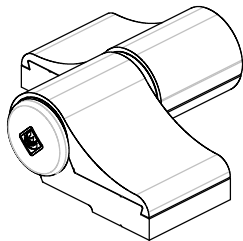

ARX.02.34

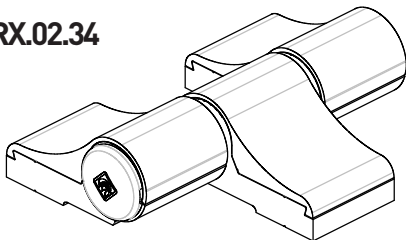

ARX.02.36

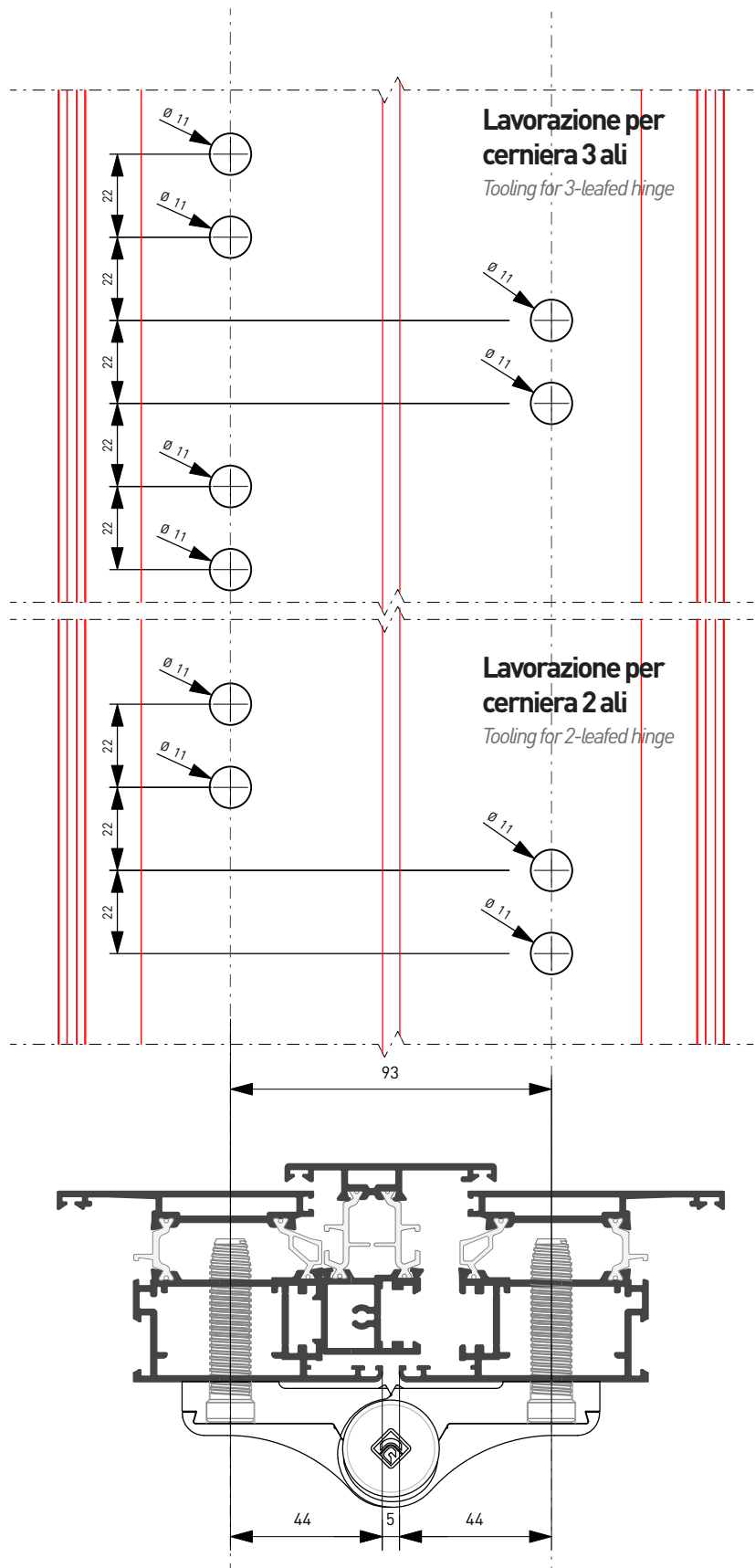
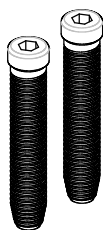

Applicazione Accessori

Accessories Application

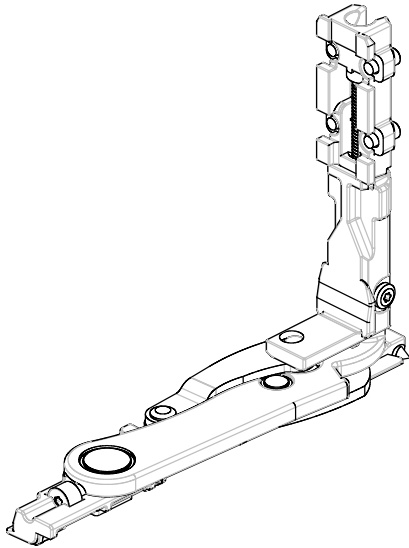

ACX.08.39
WEEN HIDE 180- Sx/Dx Cerniera inferiore
WEEN HIDE 180- Bottom Left/Right Hinge

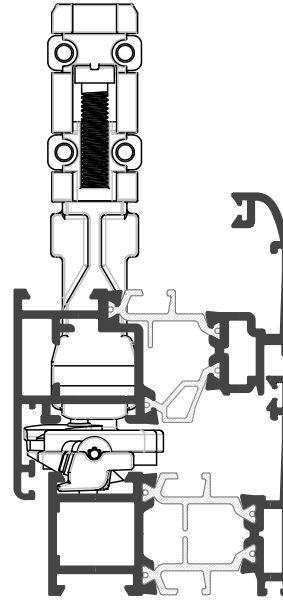

ACX.08.36
WEEN HIDE 180- Dx Braccio a scomparsa per apertura a battente
WEEN HIDE 180- Right retractable arm for hinged opening

ACX.08.37
WEEN HIDE 180- Sx Braccio a scomparsa per apertura a battente
WEEN HIDE 180- Left retractable arm for hinged opening

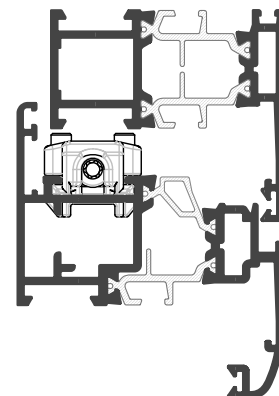
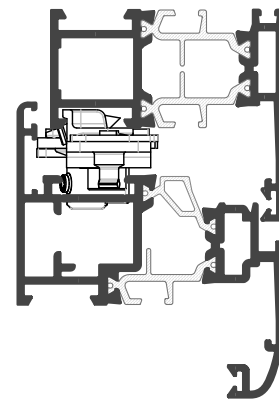
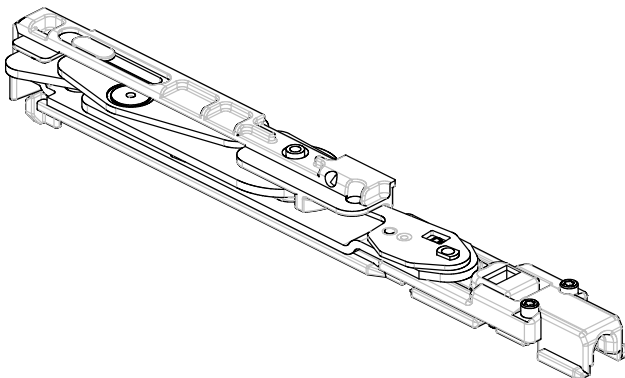

Applicazione Accessori

Accessories Application

ACX.08.40
Ween hide 180

kit base anta ribalta con anti falsa manovra sulla
cremonese ante CX70.260 e CX70.261

tilt&turn window base kit with wrong counter-actuation on the
Cremona bolt

RIBALTA
Folding

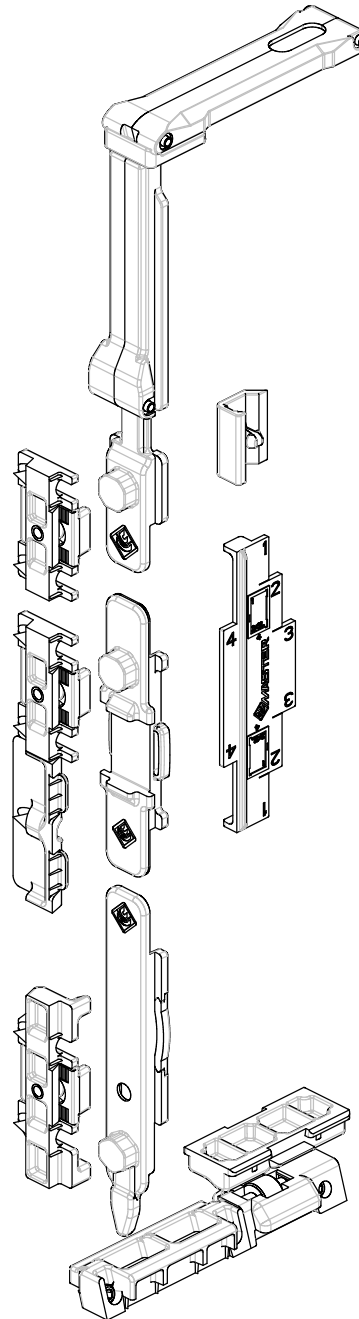
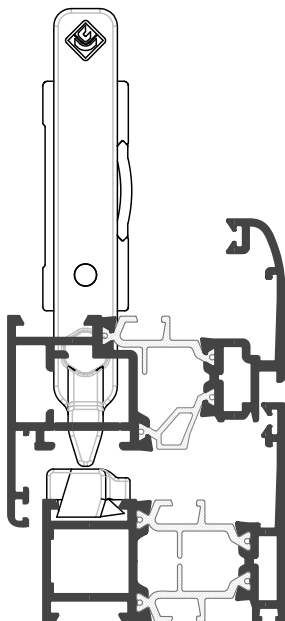
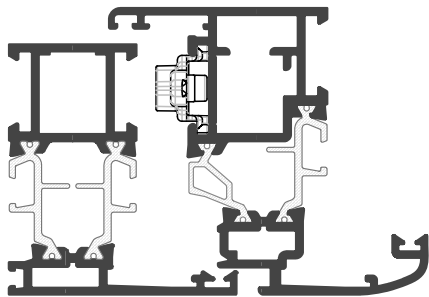
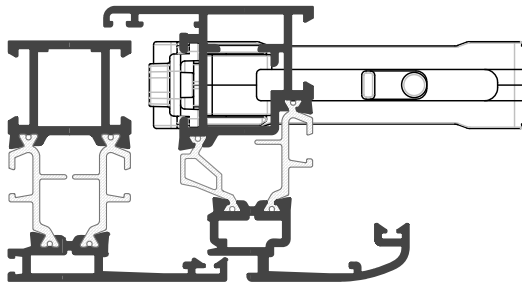

Applicazione Accessori

Accessories Application

ACX.08.41

Ween hide 180

**kit base anta ribalta con anti falsa manovra sulla
cremonese**

*tilt&turn window base kit with wrong counter-actuation on the
Cremonese bolt*

RIBALTA
Folding

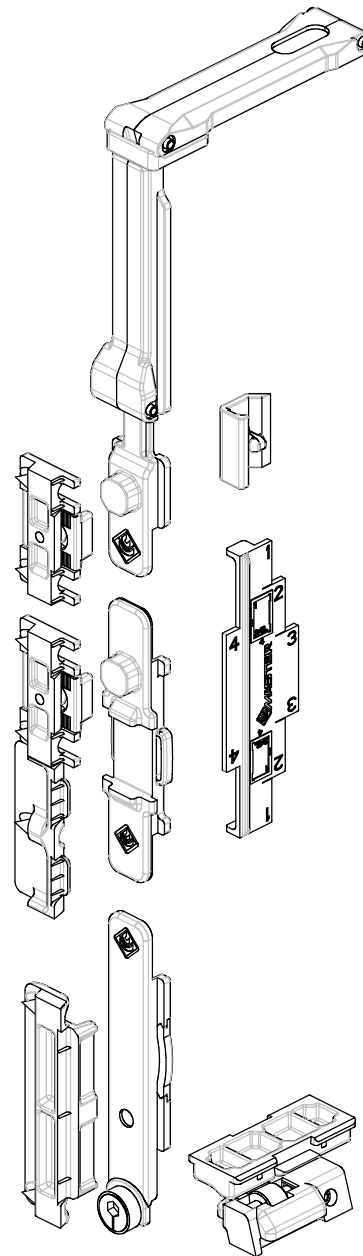
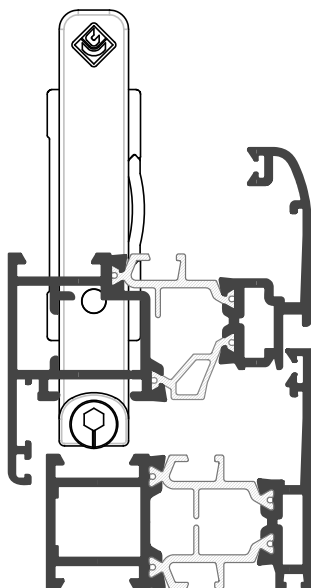
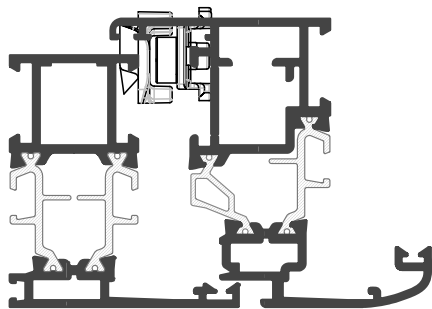
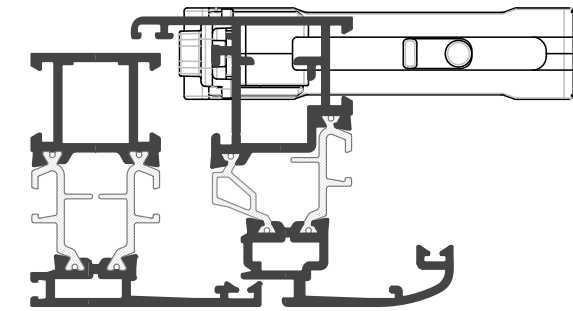



Applicazione Accessori

Accessories Application

ACX.08.01

Kit base anta ribalta

Portata massima 160Kg

tilt&turn window base kit Maximum Load 160Kg

RIBALTA
Folding

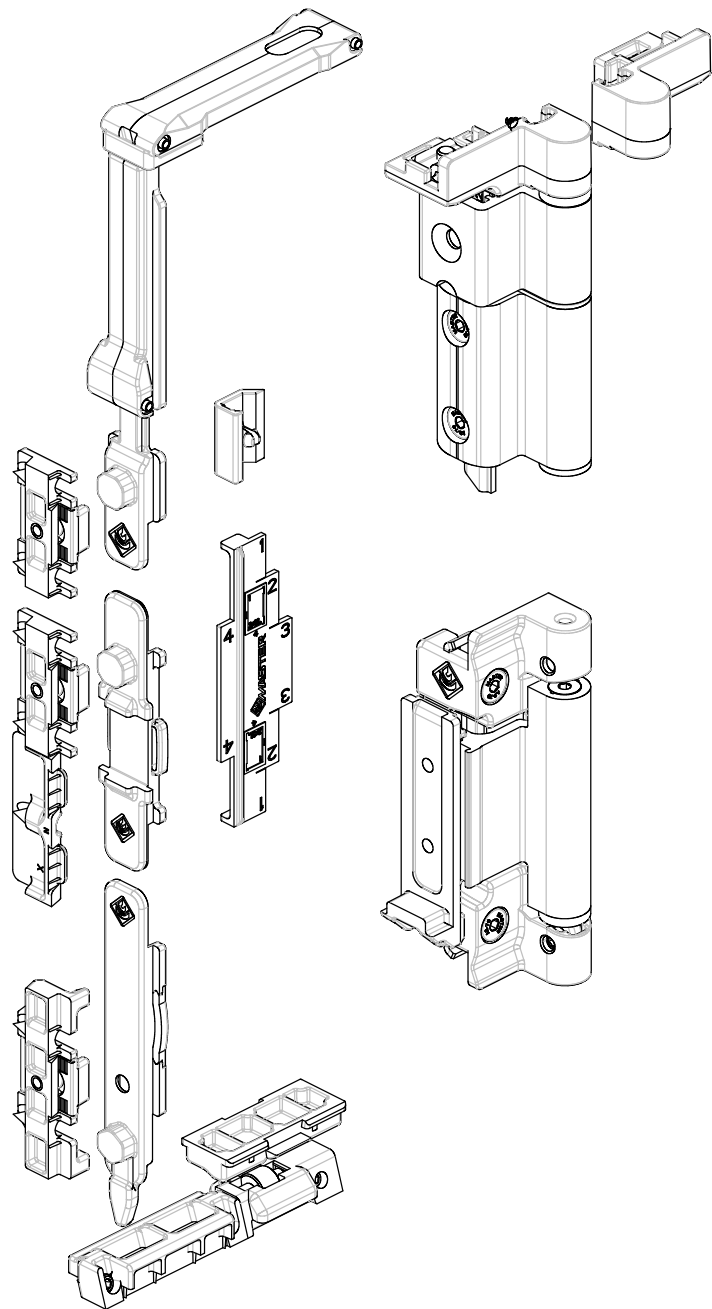
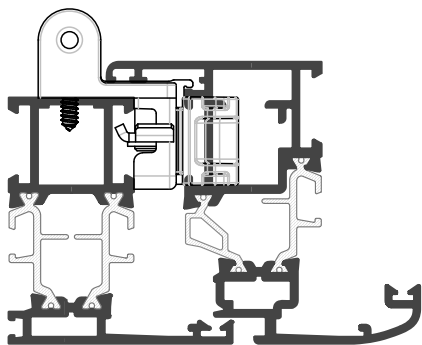
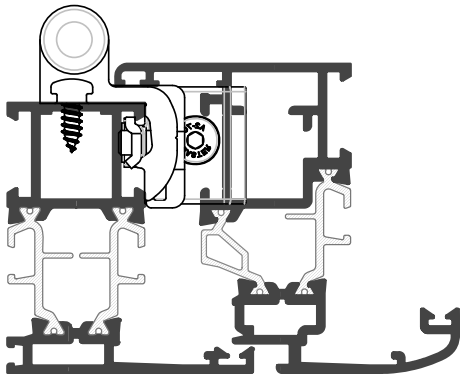

Applicazione Accessori

Accessories Application

RIBALTA
Folding

ACX.08.25
Kit cerniere e braccio per anta affiancata
Hinges and arm kit for side by side door

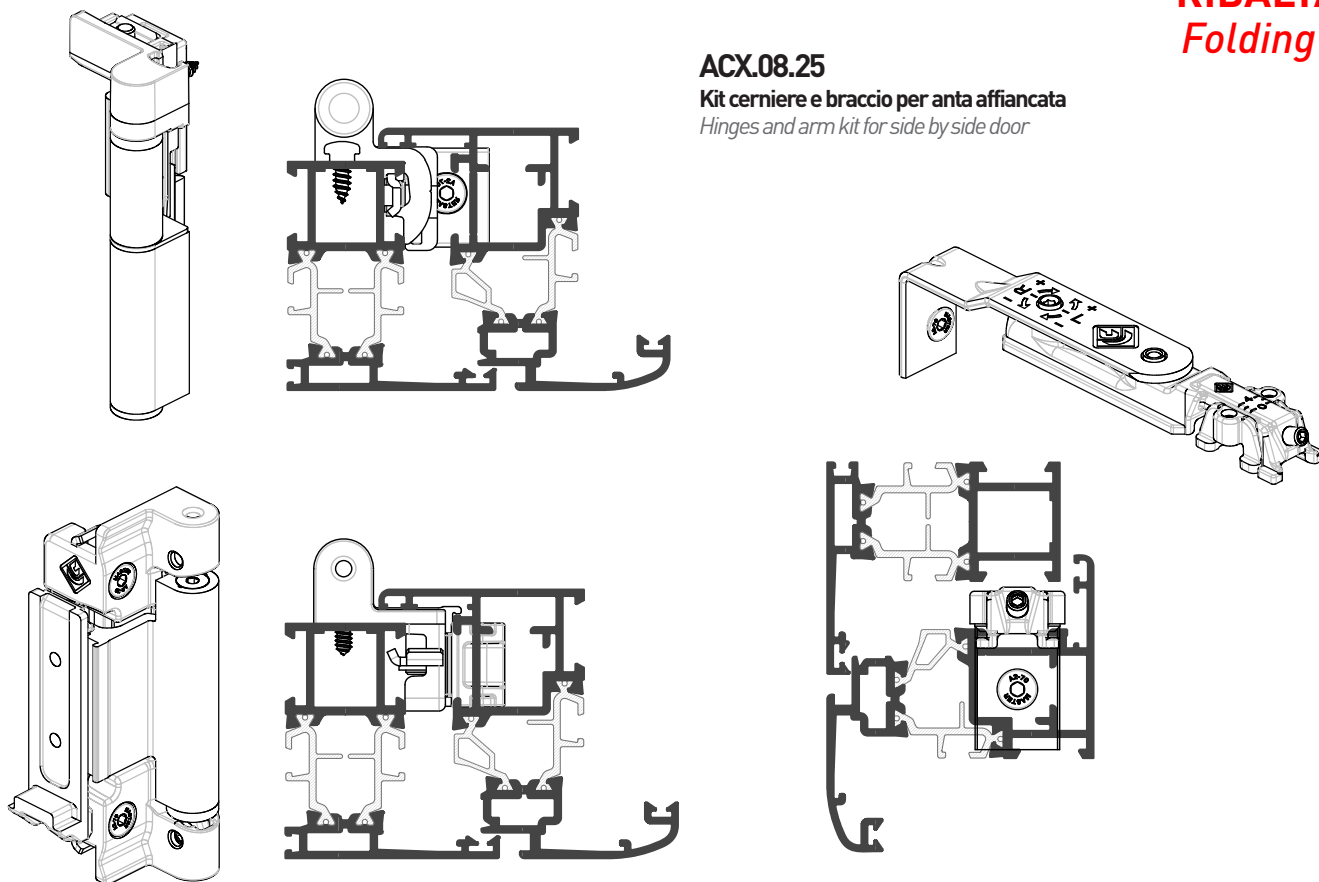

ACX.08.24
"WEEN" Braccio
lungo per anta ribalta
"WEEN" Long arm for Tilt&turn door

ACX.08.23
"WEEN" Braccio
medio per anta ribalta
"WEEN" Medium arm for Tilt&turn door

ACX.08.22
"WEEN" Braccio
corto per anta ribalta
"WEEN" Short arm for Tilt&turn door

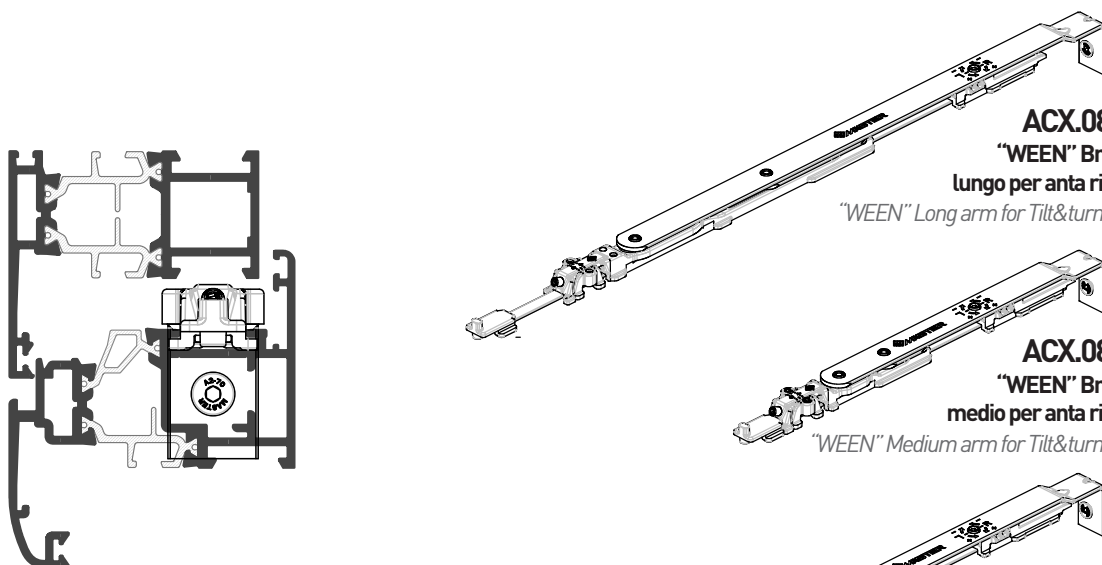



Applicazione Accessori

Accessories Application

RIBALTA
Folding

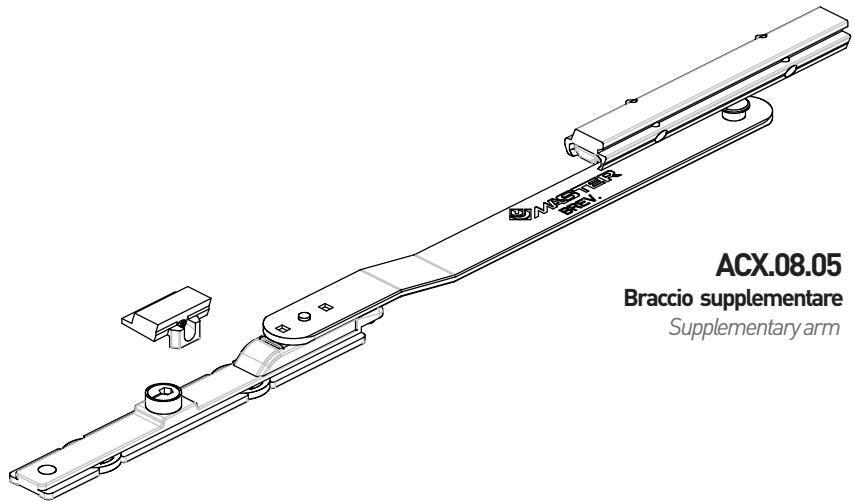
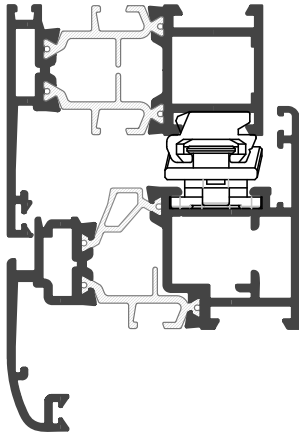

ACX.08.05
Braccio supplementare
Supplementary arm

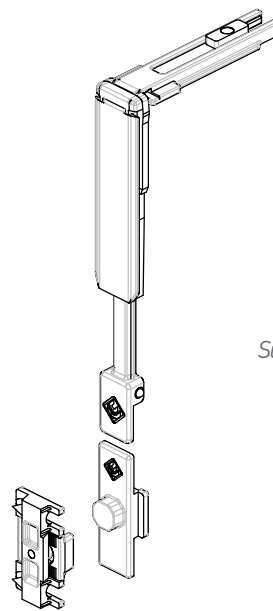
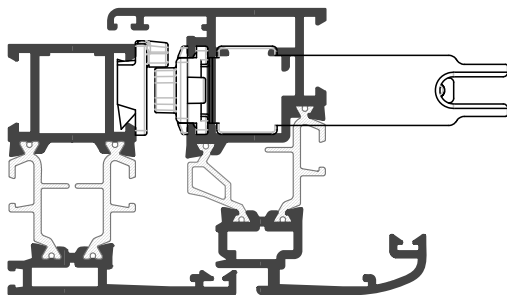

ACX.08.06
"WEEN" Chiusura
supplementare orizz./vert.
Supplementary Horizontal/Vert.

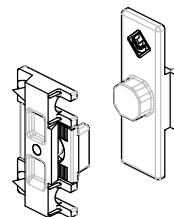
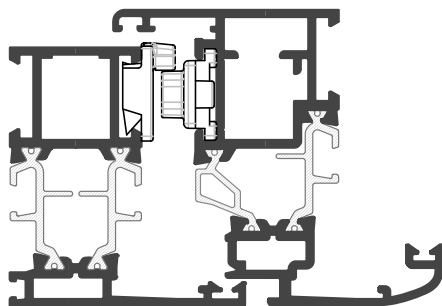

ACX.08.16
"WEEN" Punto
chiusura supplementare
"WEEN" Supplementary
closing point

Applicazione Accessori

Accessories Application

RIBALTA
Folding

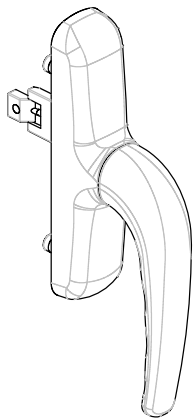

ARX.03.08
Cremonese per anta ribalta
Cremonese bolt for Tilt&turn door

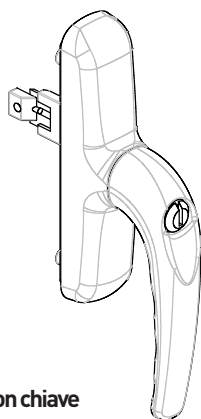
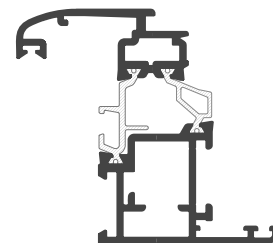
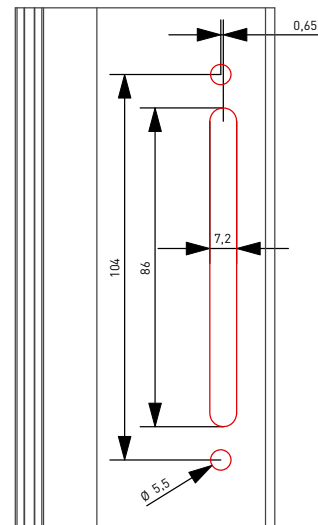
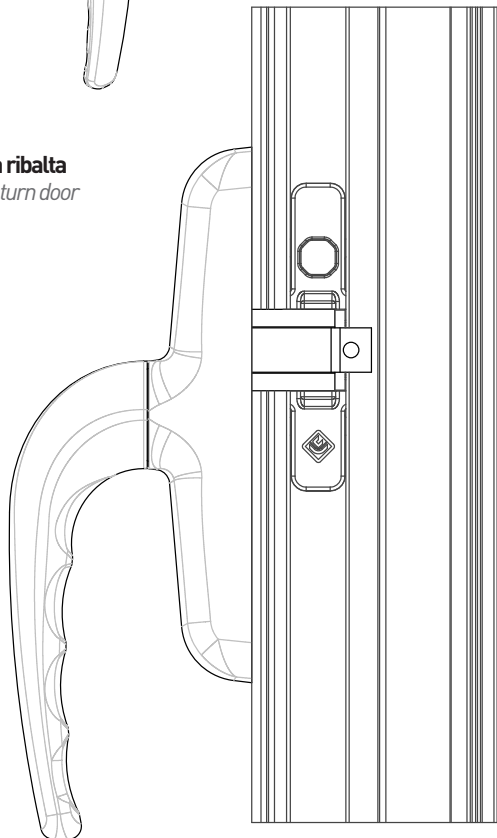

ARX.03.46
Cremonese con chiave
per anta ribalta
Cremonese bolt with cylinder lock for Tilt&turn door

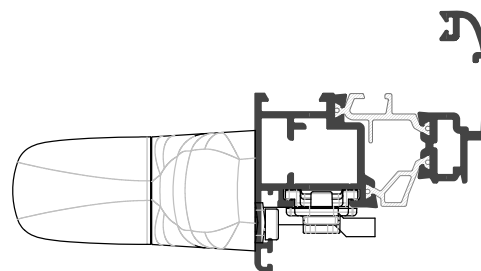

Applicazione Accessori

Accessories Application

■ Indicazioni per foratura traversi

► Indications for drilling crosspieces

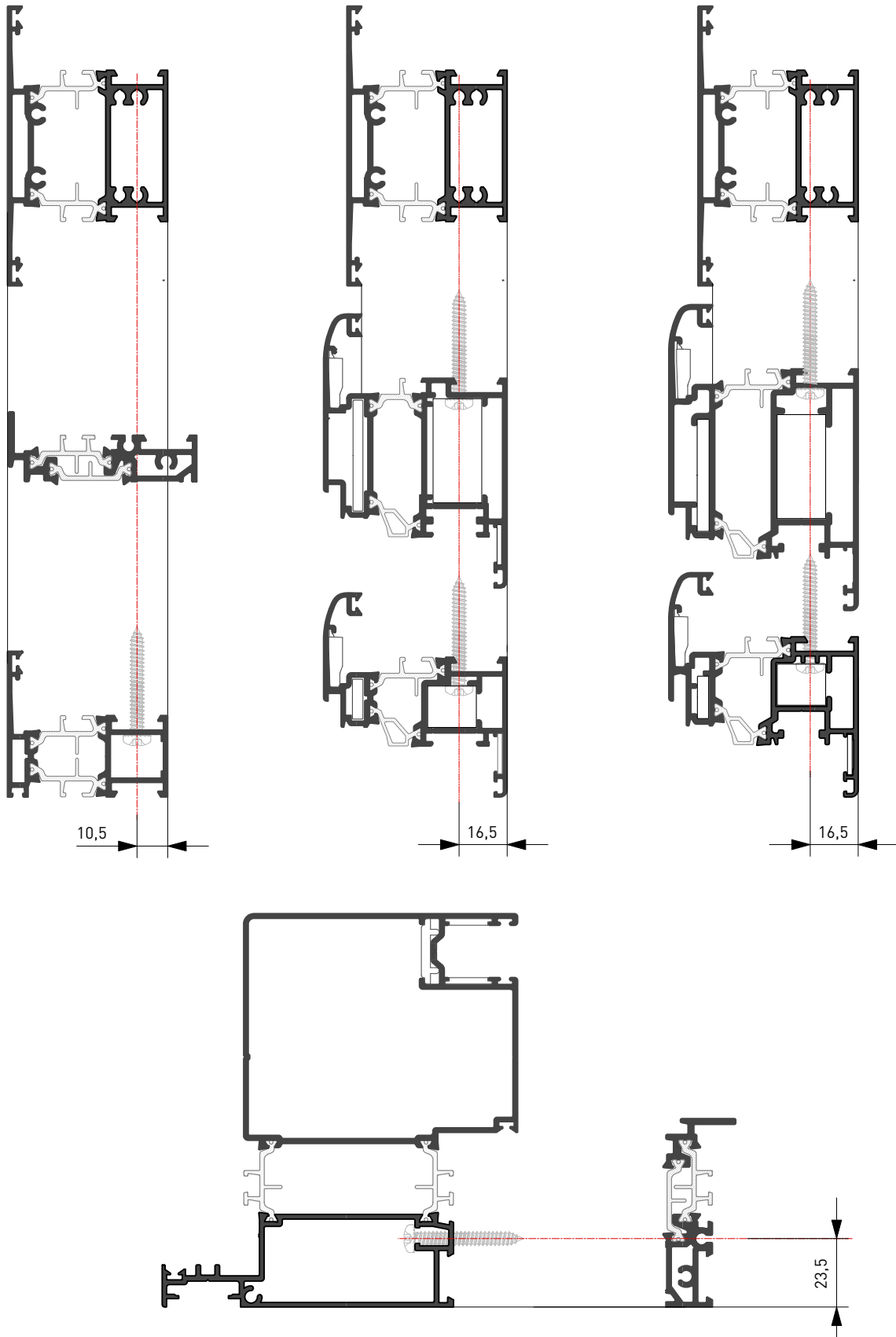



Applicazione Accessori

Accessories Application

■ Indicazioni per foratura traversi

► Indications for drilling crosspieces

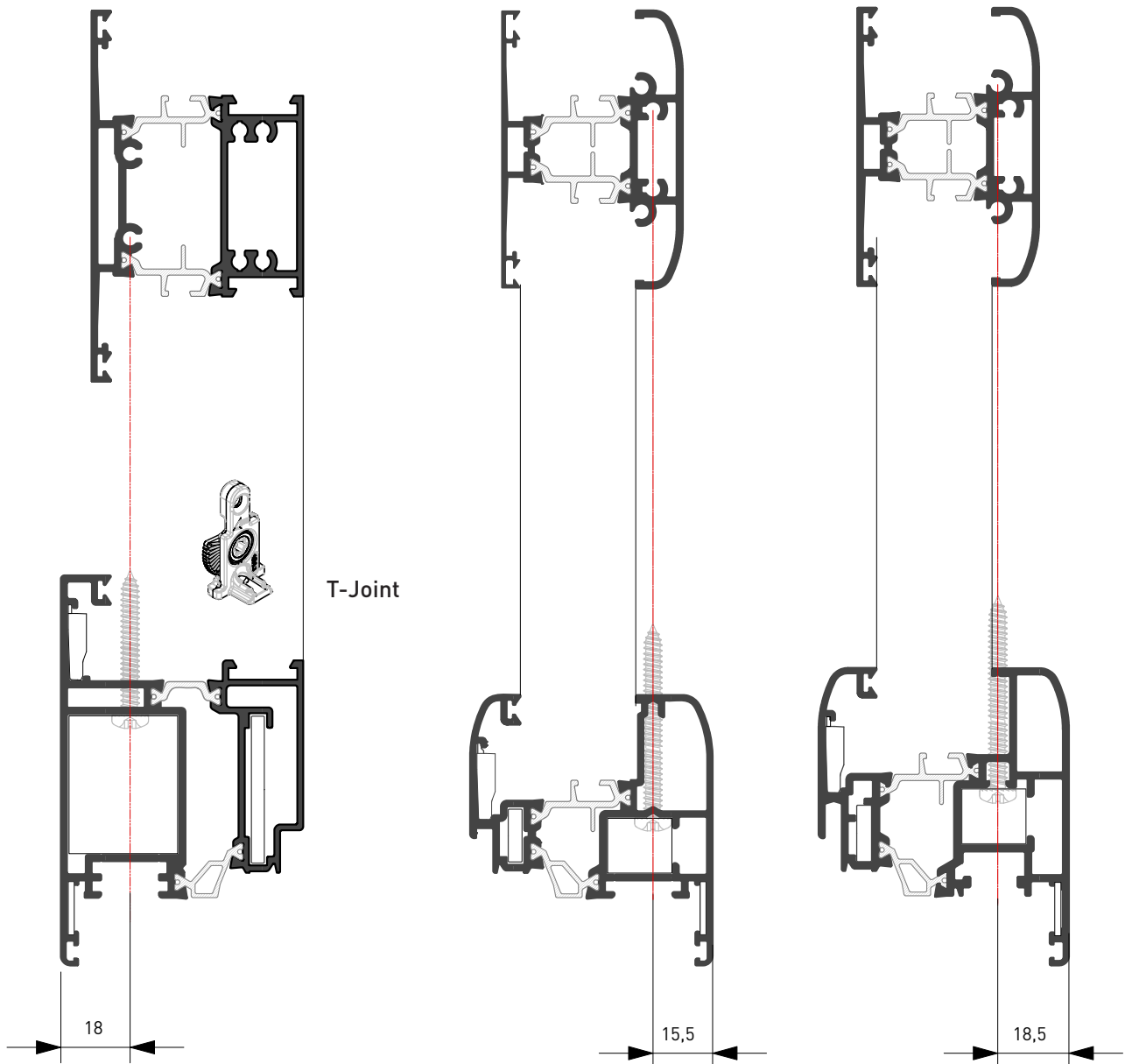



1 ANTA

Contropiastra Regolabile in Metallo			
A-B	C	D	E
06463-32	06465-22	06463-32 (17)	06465-22 (pz.2)
(17) = inserto rullo art. 06141-71			

CILINDRO SAGOMATO (Nichelato Fin.12)		Frontale
con borchie	senza borchie	
0E300-17-0-12 L=79 (29.5-49.5)	0E300-17-0-12 L=79 (29.5-49.5)	22x3

E= 35 mm

Art.19225
Art.49225
Art.49225
Art.49250
Art. 06443-31/36-0

2 ANTE

Contropiastra Regolabile in Metallo			
A-B	C	D	E
06463-32	06465-22	06463-32 (17)	06465-22 (pz.2)
(17) = inserto rullo art. 06141-71			

CILINDRO SAGOMATO (Nichelato Fin.12)		Frontale
con borchie	senza borchie	
0E300-17-0-12 L=79 (29.5-49.5)	0E300-17-0-12 L=79 (29.5-49.5)	22x3

E= 35 mm

Art.19225
Art.49225
Art.49225
Art.49250
Art. 06443-31/36-0

1 ANTA
Apertura ESTERNA

Contropiastra Regolabile in Metallo			
A-B	C	D	E
06463-32	06465-22	06463-32 (17)	06465-22 (pz.2)
(17) = inserto rullo art. 06141-71			

CILINDRO SAGOMATO (Nichelato Fin.12)		Frontale
con borchie	senza borchie	
0E300-17-0-12 L=79 (29.5-49.5)	0E300-17-0-12 L=79 (29.5-49.5)	22x3

E= 35 mm

Art.19225
Art.49225
Art.49225
Art.49250
Art. 06443-31/36-0

2 ANTE
Apertura ESTERNA

Contropiastra Regolabile in Metallo			
A-B	C	D	E
06463-32	06465-22	06463-32 (17)	06465-22 (pz.2)
(17) = inserto rullo art. 06141-71			

CILINDRO SAGOMATO (Nichelato Fin.12)		Frontale
con borchie	senza borchie	
0E300-17-0-12 L=79 (29.5-49.5)	0E300-17-0-12 L=79 (29.5-49.5)	22x3

E= 35 mm

Art.19225
Art.49225
Art.49225
Art.49250
Art. 06443-31/36-0



1 ANTA

Art. 16205

Contropiastra Regolabile in Metallo		
A-B-C	D	E-F
06463-32	06463-22 (17)	06465-22
(17) = inserto rullo art. 06141-71		

CILINDRO SAGOMATO (Nichelato Fin.12)		Frontale
con borchie	senza borchie	22x3
0E300-17-0-12 L=79 (29.5-49.5)	0E300-17-0-12 L=79 (29.5-49.5)	

E= 35 mm

Art. 16215
Art. 16225

Art. 16217
Art. 16227

Art. 46215
Art. 46225

Art. 46217
Art. 46227

Art. 46230
Art. 46250

Art. 46252

Art. 46210
Art. 46220

Art. 46212
Art. 46222

Art. 06443-00/05-0

2 ANTE

Art. 16205

Contropiastra Regolabile in Metallo		
A-B-C	D	E-F
06463-32	06463-22 (17)	06465-22
(17) = inserto rullo art. 06141-71		

CILINDRO SAGOMATO (Nichelato Fin.12)		Frontale
con borchie	senza borchie	22x3
0E300-17-0-12 L=79 (29.5-49.5)	0E300-17-0-12 L=79 (29.5-49.5)	

E= 35 mm

Art. 16215
Art. 16225

Art. 16217
Art. 16227

Art. 46215
Art. 46225

Art. 46217
Art. 46227

Art. 46230
Art. 46250

Art. 46252

Art. 46210
Art. 46220

Art. 46212
Art. 46222

Art. 06443-00/05-0

1 ANTA
Apertura ESTERNA

Art. 16205

Contropiastra Regolabile in Metallo		
A-B-C	D	E-F
06463-32	06463-22 (17)	06465-22
(17) = inserto rullo art. 06141-71		

CILINDRO SAGOMATO (Nichelato Fin.12)		Frontale
con borchie	senza borchie	22x3
0E300-17-0-12 L=79 (29.5-49.5)	0E300-17-0-12 L=79 (29.5-49.5)	

E= 35 mm

Art. 16215
Art. 16225

Art. 16217
Art. 16227

Art. 46215
Art. 46225

Art. 46217
Art. 46227

Art. 46230
Art. 46250

Art. 46252

Art. 46210
Art. 46220

Art. 46212
Art. 46222

Art. 06443-00/05-0

2 ANTE
Apertura ESTERNA

Art. 16205

Contropiastra Regolabile in Metallo		
A-B-C	D	E-F
06463-32	06463-22 (17)	06465-22
(17) = inserto rullo art. 06141-71		

CILINDRO SAGOMATO (Nichelato Fin.12)		Frontale
con borchie	senza borchie	22x3
0E300-17-0-12 L=79 (29.5-49.5)	0E300-17-0-12 L=79 (29.5-49.5)	

E= 35 mm

Art. 16215
Art. 16225

Art. 16217
Art. 16227

Art. 46215
Art. 46225

Art. 46217
Art. 46227

Art. 46230
Art. 46250

Art. 46252

Art. 46210
Art. 46220

Art. 46212
Art. 46222

Art. 06443-00/05-0



1 ANTA

Contropiastra Regolabile in Metallo			
A	B	C	Deviatori
06463-32	06463-32	06465-22	06465-22 (pz.2)
(B) Kit rullo art. 06000-00			

CILINDRO SAGOMATO (Nichelato Fin.12)		Frontale
con borchie	senza borchie	
0E300-17-0-12 L=79 (29.5-49.5)	0E300-17-0-12 L=79 (29.5-49.5)	24x3

Art. 19526
Art. 49526

E= 35 mm

18

Art. 49526

Art. 49526

2 ANTE

Contropiastra Regolabile in Metallo			
A	B	C	Deviatori
06463-32	06463-32	06465-22	06465-22 (pz.2)
(B) Kit rullo art. 06000-00			

CILINDRO SAGOMATO (Nichelato Fin.12)		Frontale
con borchie	senza borchie	
0E300-17-0-12 L=79 (29.5-49.5)	0E300-17-0-12 L=79 (29.5-49.5)	24x3

Art. 19526
Art. 49526

E= 35 mm

18

Art. 49526

Art. 49526

**1 ANTA
Apertura ESTERNA**

Contropiastra Regolabile in Metallo			
A	B	C	Deviatori
06463-32	06463-32	06465-22	06465-22 (pz.2)
(B) Kit rullo art. 06000-00			

CILINDRO SAGOMATO (Nichelato Fin.12)		Frontale
con borchie	senza borchie	
0E300-17-0-12 L=79 (29.5-49.5)	0E300-17-0-12 L=79 (29.5-49.5)	24x3

Art. 19526
Art. 49526

E= 35 mm

18

Art. 49526

Art. 49526

**2 ANTE
Apertura ESTERNA**

Contropiastra Regolabile in Metallo			
A	B	C	Deviatori
06463-32	06463-32	06465-22	06465-22 (pz.2)
(B) Kit rullo art. 06000-00			

CILINDRO SAGOMATO (Nichelato Fin.12)		Frontale
con borchie	senza borchie	
0E300-17-0-12 L=79 (29.5-49.5)	0E300-17-0-12 L=79 (29.5-49.5)	24x3

Art. 19526
Art. 49526

E= 35 mm

18

Art. 49526

Art. 49526



1 ANTA

2 ANTE

A

Contropiastra Regolabile in Metallo			
A	B	C	Deviatori
06463-22	06463-22	06465-22	06465-22 (pz.2)
[17] = inserto rullo art. 06141-71			

CILINDRO SAGOMATO (Nichelato Fin.12)		Frontale
con borchie	senza borchie	
0E300-17-0-12 L=79 (29.5-49.5)	0E300-17-0-12 L=79 (29.5-49.5)	24x3

Art. 16525
Art. 46525

B

E= 35 mm

Art. 46550

C

Art. 46520

A

Contropiastra Regolabile in Metallo			
A	B	C	Deviatori
06463-32	06463-22	06465-22	06465-22 (pz.2)
[17] = inserto rullo art. 06141-71			

CILINDRO SAGOMATO (Nichelato Fin.12)		Frontale
con borchie	senza borchie	
0E300-17-0-12 L=79 (29.5-49.5)	0E300-17-0-12 L=79 (29.5-49.5)	24x3

Art. 16525
Art. 46525

B

E= 35 mm

Art. 46550

C

Art. 46520

1 ANTA

2 ANTE

A

Contropiastra Regolabile in Metallo			
A	B	C	Deviatori
06463-32	06463-22	06465-22	06465-22 (pz.2)
[17] = inserto rullo art. 06141-71			

CILINDRO SAGOMATO (Nichelato Fin.12)		Frontale
con borchie	senza borchie	
0E300-17-0-12 L=79 (29.5-49.5)	0E300-17-0-12 L=79 (29.5-49.5)	24x3

Art. 16525
Art. 46525

B

E= 35 mm

Art. 46550

C

Art. 46520

Apertura ESTERNA

A

Contropiastra Regolabile in Metallo			
A	B	C	Deviatori
06463-32	06463-22	06465-22	06465-22 (pz.2)
[17] = inserto rullo art. 06141-71			

CILINDRO SAGOMATO (Nichelato Fin.12)		Frontale
con borchie	senza borchie	
0E300-17-0-12 L=79 (29.5-49.5)	0E300-17-0-12 L=79 (29.5-49.5)	24x3

Art. 16525
Art. 46525

B

E= 35 mm

Art. 46550

C

Art. 46520

Apertura ESTERNA



1 ANTA Apertura ESTERNA

2 ANTE Apertura ESTERNA

A

Contropiastra Regolabile in Metallo		Accessori		
A	Deviatori	1/2 Maniglia	Aste	Blocca Aste
06463-32	06465-22 (pz.2)	07070-66-0-B1	-	-
Utilizzare salvaprofilo art. -		Bocchetta Pavimento art. -		
CILINDRO SAGOMATO (Nichelato Fin.12)		Frontale		
con borchie		senza borchie		24x3
0E300-17-0-12 L=79 (29.5-49.5)		0E300-17-0-12 L=79 (29.5-49.5)		

E= 40 mm

Art. 43725 Funz. A/D
Art. 43735 Funz. B

Maniglione FAST Touch Quadro 8mm
art. 59711-00
art. 59711-01

Quadro Maniglia
art. 07085-77-0

Maniglione FAST Push Quadro 8mm
art. 59607-10

Barra Ovale
art. 07007-XX

A

Contropiastra Regolabile in Metallo		Accessori		
A	Deviatori	1/2 Maniglia	Aste	Blocca Aste
43295-75	06465-22 (pz.2)	07070-66-0-B1	07088-03	07089-52 (Facoltativo)
Utilizzare salvaprofilo art. -		Bocchetta Pavimento (in dotazione alla contro serratura) art. 06142-85		
CILINDRO SAGOMATO (Nichelato Fin.12)		Frontale		
con borchie		senza borchie		24x3
0E300-17-0-12 L=79 (29.5-49.5)		0E300-17-0-12 L=79 (29.5-49.5)		

E= 40 mm

Art. 43725 Funz. A/D
Art. 43735 Funz. B

Maniglione FAST Touch Quadro 8mm
art. 59711-00
art. 59711-01

Quadro Maniglia
art. 07085-77-0

Maniglione FAST Push Quadro 8mm
art. 59607-10

Barra Ovale
art. 07007-XX

A Bocchetta Superiore

Art. 06141-80

B Boccola

Art. 06147-01

C Blocca Aste

Art. 07089-52

A Aste

Art. 07088-03

Sezione Verticale - Riarmo Manuale

A Bocchetta Superiore

Art. 06141-80

B Boccola

Art. 06147-01

C Blocca Aste

Art. 07089-52

A Aste

Art. 07088-03

Sezione Verticale - Riarmo Automatico

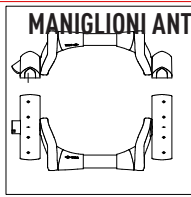
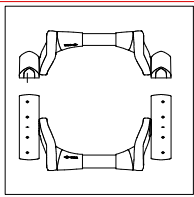

MANIGLIONI ANTIPANICO APPLICARE FAST

- FAST PUSH**
- 59001-10-0
 - 59016-10-0
- Barra Ovale**
- 07007-14-0 (acciaio verniciato)
 - 07007-61-0 (inox)

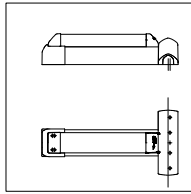
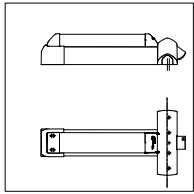

- FAST TOUCH (L=1200)**
- 59801-10-0
 - 59811-10-0
 - 59816-10-0
- FAST TOUCH (L=840)**
- 59801-09-0
 - 59811-09-0
 - 59816-09-0

- eFAST**
- 59851-10-0

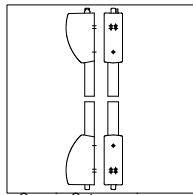
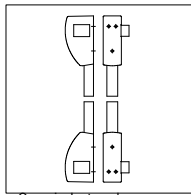
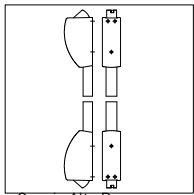

Coppia Alto Basso
07063-61-0

Coppia Laterale
07063-51-0

Coppia Catenacci
07063-71-0

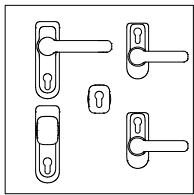

- Comandi Esterni**
- 07078-68-0
 - 07078-69-0
 - 07078-38-0
 - 07078-36-0
 - 07078-35-0

Accessori

- Kit Prolunga 07064-51-0
- Incontro Laterale 07072-11-0
- Micro Fast Touch 06195-05-0
- Micro Fast Push 06195-06-0
- Micro Comando Est. 06195-10-0
- Passacavo 06515-21-0
- Ingegno 06198-70-0

1 ANTA Apertura ESTERNA

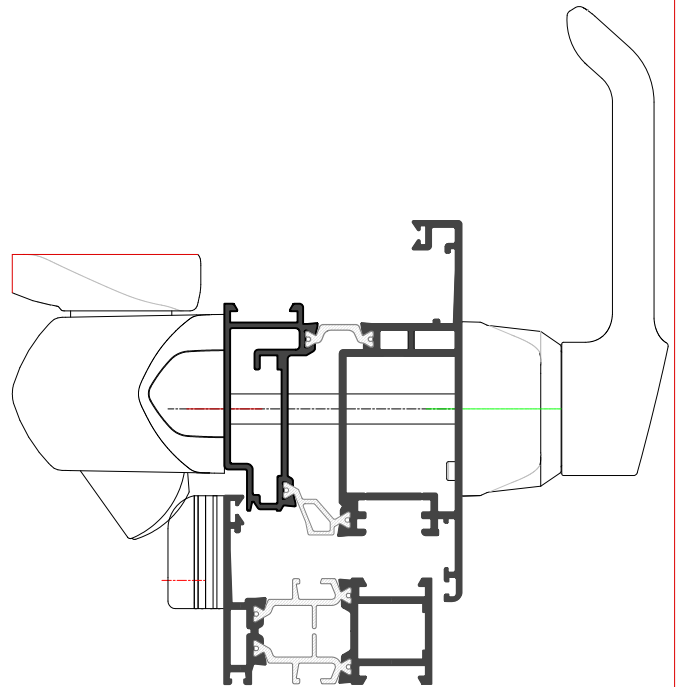

2 ANTE Apertura ESTERNA

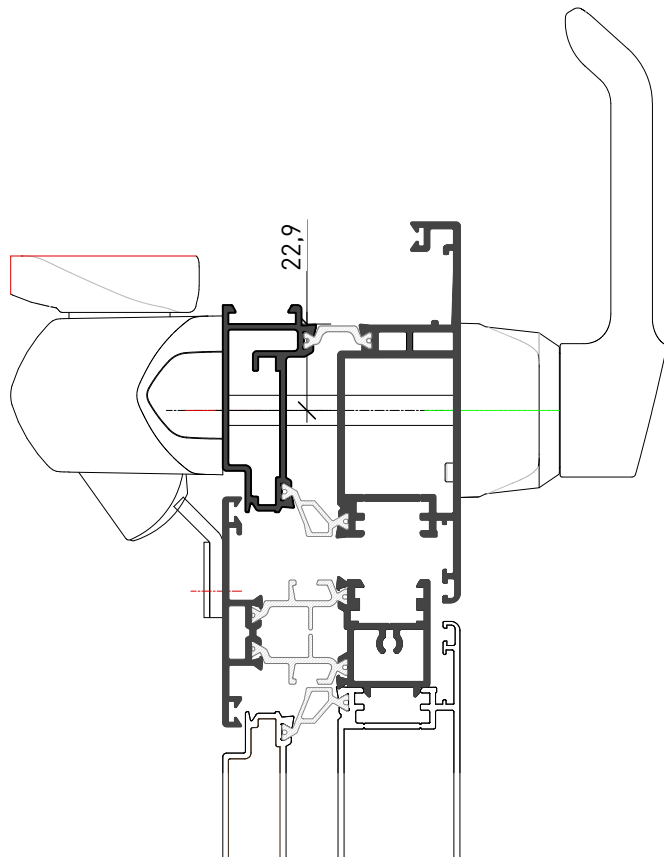

Sezione Verticale

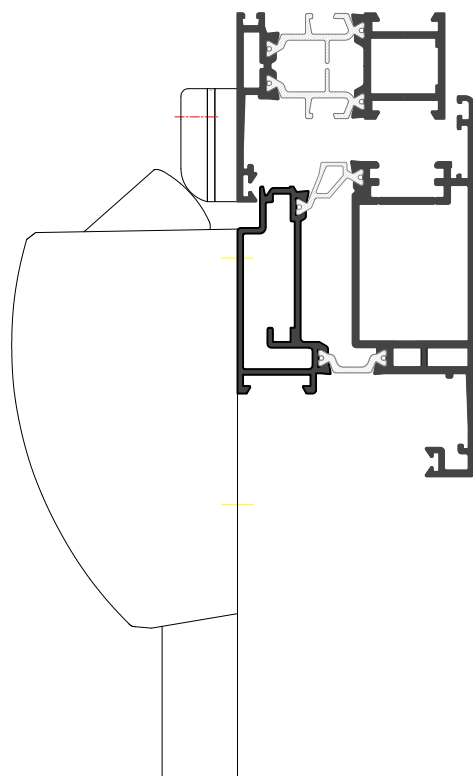



MANIGLIONI ANTIPANICO APPLICARE FAST
Sezione Pavimento

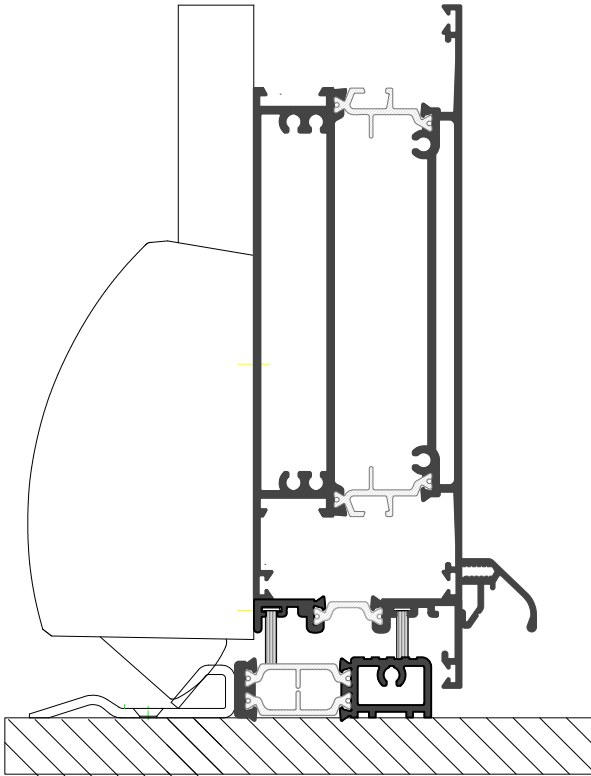

Gli archivi digitali dei prodotti TWIN SYSTEMS
sono disponibili nei formati:

*The digital files of the TWIN SYSTEMS
products are available in the formats at:*



AUTODESK[®]
AUTOCAD[®]



AUTODESK[®]
REVIT[®]

www.twinsystems.it/web/richiesta-dwg

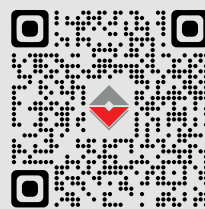

Il presente Catalogo assieme ai cataloghi di tutti i
prodotti TWIN SYSTEMS sono liberamente scaricabili:

*This Catalog together with the catalogs of all TWIN SYSTEMS
products can be downloaded freely at:*

www.twinsystems.it/professionisti/cataloghi/

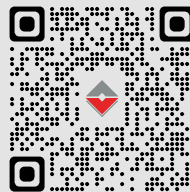

PAGINA Cataloghi
CATALOGUES Webpage

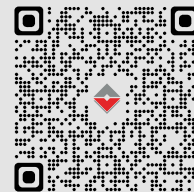

LINEA PRODOTTI
PRODUCTS Line

PAM SYSTEM S.r.L.

S.S. 230 - Fornace Crocicchio 13030 Formigliana (VC)
Tel. 0161 858811 - Fax 0121 858800
www.pamsystemsrl.com | info@pamsystemsrl.com

ALQ GENOVA s.r.l.

Direzione & Magazzino

Via Colano, 9/A 12/K 16162 Genova Bolzaneto (GE)
Tel. 010 7491941 - Fax 010 7450155

Magazzino

Via Meucci, 25 Calenzano 50041 (FI)
Tel. +39 055 8825060 Fax: +39 055 8824916
www.alqsystem.it | info@alqgenovasrl.com

PAESANI GROUP

Direzione & Magazzino

Via del Grano, 260 47822 Santarcangelo di Romagna (RN)
Tel. 0541 748511

www.paesani.com | info@paesani.com

Magazzino Nord

Via Luigi Bonati, 21 29017 Fiorenzuola d'Arda (PC)
Tel. 0523 943138
magazzinonord@paesani.com

DIVA s.a.s

Via Po, 25 - Z.I. Sambuceto 66020 S.Giovanni Teatino (CH)
Tel. 085 4405210 - Fax 085 4405207

www.camel-diva.com | info@camel-diva.com

EUROALL S.r.l.

Strada Comunale della Mola Saracena, 23 00065 Fiano Romano (RM)

Tel. 0765 455228/61 - Fax 0765 455317

www.euroallslrl.it | info@euroallslrl.it

PROFILATI UMBRIA S.r.l.

Via Dei Tigli, 35 - 06083 Bastia Umbra (PG)
Tel. 075 8012385 | 075 8010328 - Fax 075 8012386
info@profilatiumbria.it

TSL ALLUMINIO S.r.l.

Via delle Industrie, 12 00030 San Cesario (Roma)
Tel. 06 2251591 (Ric. Aut.) - Fax 06 2280693
www.tslalluminio.it | info@tsllalluminio.it

ALLCAR SERVICE S.r.l.

Via Acuto, 120 - 00131 Roma
Tel. 06 4130626 (Ric. Aut.) - Fax 06 4130367
www.allcarservice.it | allcarservice@mclink.it

ALLUCOM S.r.l.

Andria

Via Vecchia Barletta 237 Z. Ind. - 76123 Andria (BT)
Tel. 0883 592213 - Fax 0883 552386

Bari

Via Zippitelli, 28/B - 70123 (BA)
Tel. 0805058608 - Fax 0805058607
www.allucom.com | info@allucom.com

CARUSO S.r.l.

Z.I. Contrada Le Macere 86019 Vinchiatturo (CB)
Tel. 0874 340024 - Fax 0874340025
carusosrl1@libero.it

CAIMAR S.n.c.

Direzione & Magazzino

Strada Prov.le Rimedio-Torregrande Km. 4
09072 Cabras (OR) - Tel. 0783 290118

Filiale

Fronte S.S. 131 Km. 17,450 - 09023 Monastir (CA)
Tel. 070 9166020 - Fax 070 9166191
www.caimar.it | caimarmail@caimar.it

SALENTO METALLI S.r.l.

Via Federico II, 13 - Zona PIP - 73020 Cavallino (LE)
Tel. 0832 614576 - Fax 0832 614635
www.salentometalli.it | info@salentometalli.it

MIDA ALLUMINIO S.r.l.

Napoli

Via Piano del Principe, 36
80047 San Giuseppe Vesuviano (NA)
Tel. 081 5297373 - Fax 081 8284449

Salerno

Loc. Terzerie, Z.I. - 80061 Ogliastro Cilento (SA)
Tel. 0974 833233 - Fax 0974 844724
www.gruppomida.it | info@gruppomida.it

ITALBACOLOR S.r.l.

C.da Valle S. Maria - 87024 Fuscaldo (CS)
Tel. 0982 618025 - Fax 0982 720235
www.italbacolor.it | commerciale@italbacolor.it

COMAS S.r.l.

Via Porta Palermo, 84 - 91011 Alcamo (TP)
Tel. 0924 507050 - Fax 0924 507051
www.comasgroup.it | info@comasgroup.it

ALUK TIM

Aluk Tim D.o.o.

Žegoti 10, 51215 Kastav Croazia, UE
Tel: +385 (0) 51/691 461 - Fax: +385 (0) 51/691 473

Filiale di Zagabria

Franje Lučića, 34A Zagabria Croazia, UE
Tel: +385 (0) 1 6462 611 - Fax: +385 (0) 1 6462 610
Mob: +385 (0) 99 2939656

zagreb@aluk.hr

Filiale Spalato

Street Sv. Nikole Tavelića, 13A 21204
Dugopolje Croazia, UE
Tel: +385 (0) 21225525
Fax: +385 (0) 21660110
Mob: +385 (0) 99 2199228
split@aluk.hr



  www.twinsystems.it
info@twinsystems.it

Consorzio **TWIN SYSTEMS**
Via delle Macere, 20 | 00060 Formello [Roma]
Tel./Fax 06 23260298