

CX700HP

HIGH PERFORMANCE

FINESTRE A BATTENTE
CON TAGLIO TERMICO



TWIN
SYSTEMS

ARCHITETTURE IN ALLUMINIO

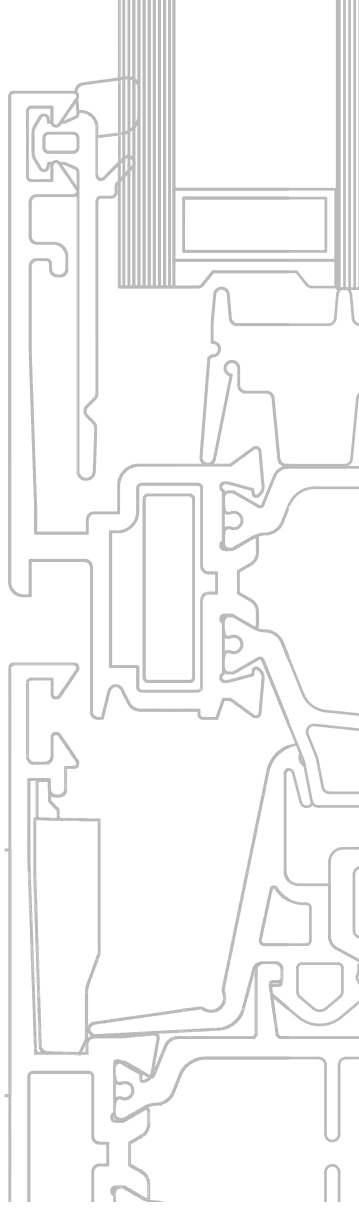

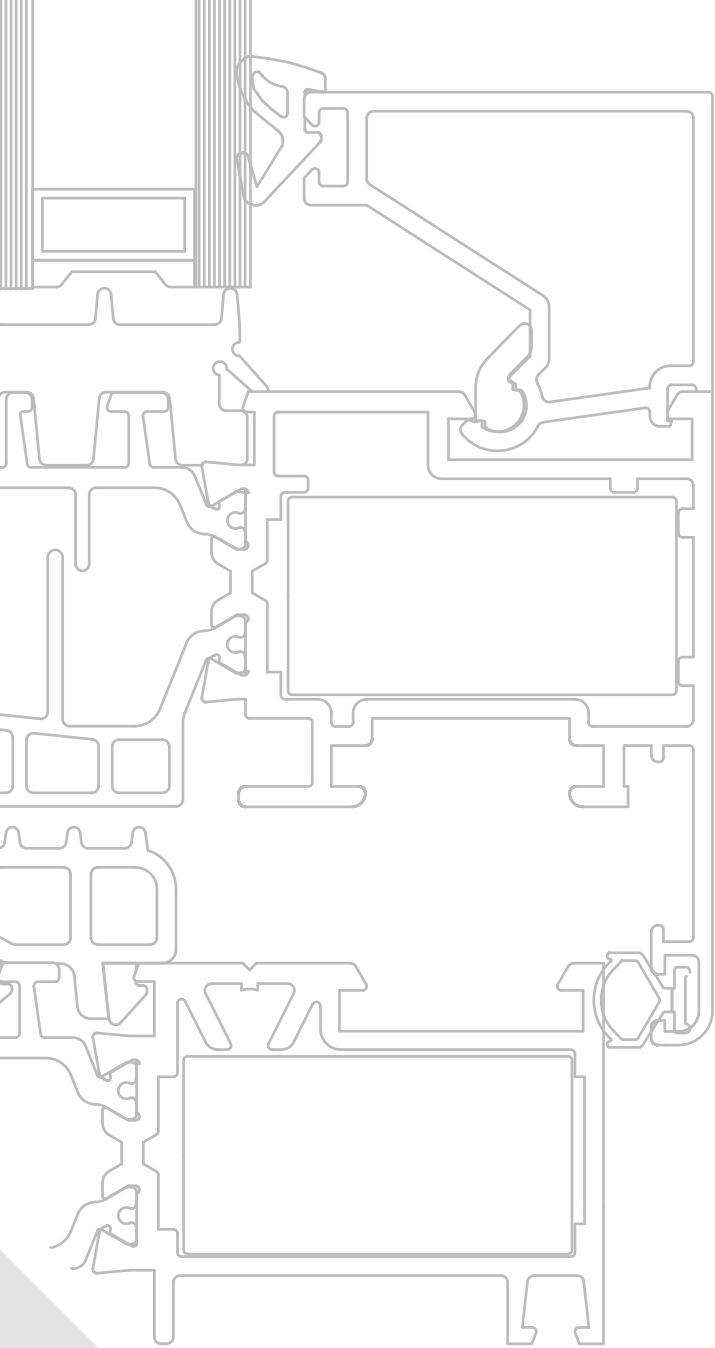

CX700HP

HIGH PERFORMANCE

FINESTRE A BATTENTE
CON TAGLIO TERMICO



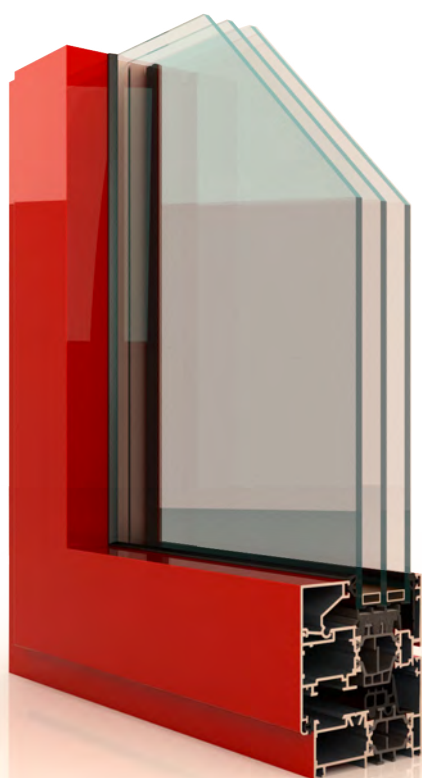

Informazioni generali

Gruppo A

Indice generale
Caratteristiche alluminio
Descrizione tecnica sistema
Descrizione tecnica capitolato
Collaudi prestazionali

Profilati

Gruppo B

Elenco profilati
Profilati scala 1.1

Accessori e Guarnizioni

Gruppo C

Elenco accessori
Elenco guarnizioni

Sezioni

Gruppo D

Sezioni principali
in scala 1:1
corredate dei relativi accessori

Tipologie

Gruppo E

Principali tipologie di finestre

Collegamento muratura

Gruppo F

Sezione particolareggiata
attacco alla muratura

Lavorazioni / Montaggi

Gruppo G

Schemi lavorazioni
Frese
Attrezzature

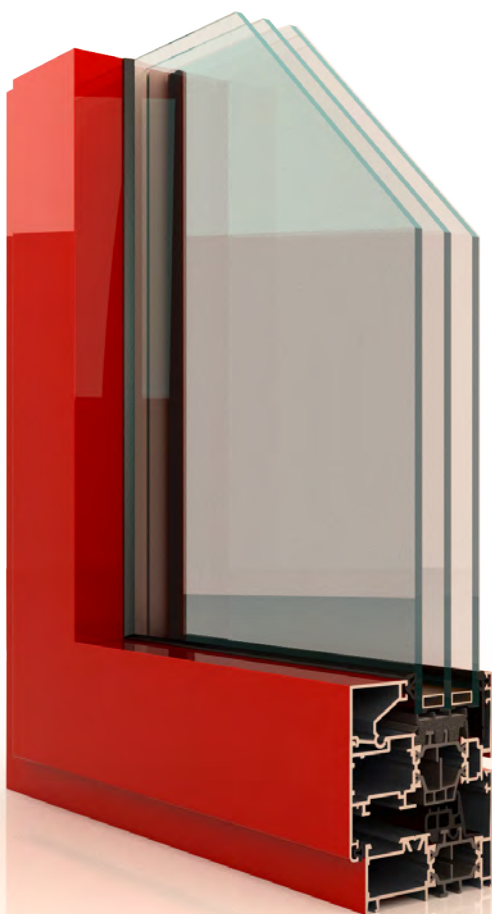

Informazioni
Generali

Gruppo A



PESO PROFILATI

Il peso indicato è quello teorico e potrà variare in funzione delle tolleranze di spessore e dimensionali dei profilati (NORMA UNI EN 12020-2)

LEGA DI ESTRUSIONE

I profilati sono estrusi in lega EN-AW-6060 (UNI EN 573/3)

DIMENSIONI DEI PROFILATI

Le dimensioni indicate sono quelle teoriche, potranno quindi variare in funzione delle tolleranze dimensionali di estrusione (norma UNI EN 12020-2). Questa variabilità che interessa tutti i profilati, può influire, anche se minimamente, sulle dimensioni di taglio e quindi finali del serramento. Anche la verniciatura, aumentando gli spessori, contribuisce a far variare la dimensione dei profilati e, particolarmente, riduce lo spazio nelle sedi di inserimento delle guarnizioni e degli accessori.

DIMENSIONI DI TAGLIO E LAVORAZIONI

Le dimensioni teoriche di taglio e le quote delle lavorazioni indicate nel presente catalogo sono esatte, ovvero matematicamente corrette, in certi casi dovranno, nella pratica, essere adattate in base alla precisione ed al tipo di impostazione delle misure delle macchine utilizzate. È pertanto consigliabile nei primi lavori o nel caso di importanti quantità di serramenti effettuare delle campionature di prova.

PROTEZIONE SUPERFICIALE

Al fine di limitare i processi di corrosione filiforme è importante applicare le seguenti regole:

- utilizzare accessori di assemblaggio in alluminio utilizzare viti in acciaio inox ,
- proteggere le parti tagliate e lavorate con prodotti idonei
- evitare ristagni di condense all'interno dei profilati.

Per la realizzazione di serramenti è necessario attenersi alla tecnologia costruttiva e utilizzare le guarnizioni e gli accessori originali riportati sul catalogo tecnico e al rispetto delle norme, prescrizioni e raccomandazioni vigenti. L'osservanza di quanto sopra determina la garanzia .Su queste basi sono stati realizzati campioni che, collaudati in laboratorio hanno ottenuto i risultati indicati nelle certificazioni. Per il buon funzionamento e la durata degli infissi realizzati con profilati ed accessori del sistema , è necessario effettuare alcune semplici operazioni: una buona pulizia, eliminando residui di calce, cemento e/o altro. È consigliabile peraltro proteggere il manufatto sino al momento della messa in esercizio, lubrificare con olio o grasso neutri le parti in movimento e gli organi di chiusura, controllare il corretto serraggio delle viti e dei grani, controllare gli assetti, registrandoli laddove sono previste regolazioni. Si raccomanda di effettuare queste operazioni almeno con cadenza semestrale. In caso di funzionamento anomalo di qualche componente, evitare assolutamente interventi atti a modificarne le caratteristiche e la sostituzione con ricambi non originali. Ci sembra utile ricordare che interventi di regolazione e/o sostituzione, con particolare riferimento ai meccanismi per oscillo-battente, andranno eseguiti da personale specializzato. Si raccomanda inoltre, in occasione delle operazioni di pulizia, di non utilizzare detergenti che possano deteriorare i trattamenti superficiali, escludendo tassativamente acidi, solventi, materiali abrasivi, spazzole metalliche o comunque in grado di scalfire le superfici, pagliette metalliche e altro.

DIMENSIONI E TIPOLOGIA DEI SERRAMENTI

La valutazione delle dimensioni dei serramenti, richiede la considerazione di vari fattori quali: il momento d'inerzia dei profilati ,le dimensioni e il peso dei tamponamenti (vetri-pannelli),la larghezza e l'altezza delle parti apribili caratteristiche e portate degli accessori,le condizioni e le quantità degli ancoraggi alle opere morte,l'esposizione, ecc...Fattori che sono valutabili e applicabili, grazie alla buona conoscenza dello stato dell'arte, alle informazioni riportate dai cataloghi, manuali tecnici e dalle normative vigenti. Consigliamo, al fine di evitare inutili contestazioni, di consultare il nostro servizio tecnico sistemi, prima di realizzare serramenti che, per dimensione, forma, esposizione e/o altro possono essere ritenuti atipici. Le soluzioni e le combinazioni proposte in questo catalogo, non hanno carattere limitativo, ma presentano solo le situazioni e combinazioni più comunemente riscontrabili nella realtà. Soluzioni e combinazioni diverse, così come l'adozione di componentistica particolare, ad esempio meccanismi per la realizzazione di ante scorrevoli parallele, ante scorrevoli a libro o altro, sono possibili. A questo proposito il nostro servizio tecnico prodotti per l'edilizia può valutare e proporre le soluzioni più idonee.



DESCRIZIONE TECNICA PER CAPITOLATO

I profilati per serramenti saranno in lega di alluminio ENAW 6060 (EN 573-3 e EN 755-2) con stato fisico di fornitura UNI EN 515. I telai fissi e le ante mobili dovranno essere realizzati con profilati ad interruzione di ponte termico a tre camere (profilo interno ed esterno tubolari, collegati tra di loro con barrette in poliammide PA 6.6 rinforzate con fibra di vetro).

INFISSI

Le finestre e le porte finestre dovranno avere un profilato di telaio fisso con profondità minima 70 mm. ed un profilato di anta mobile con profondità minima 78 mm. I profilati di telaio fisso dovranno prevedere, dove necessario, alette incorporate di battuta interna sulla muratura da 22 mm . I profilati di ante mobili dovranno avere un'aletta esterna di battuta per vetro con altezza di 22 mm ed una aletta di battuta interna sul telaio fisso con sormonto di 6 mm. La barretta in poliammide del profilato anta a contatto con la guarnizione di tenuta centrale (giunto aperto), dovrà essere di forma tubolare.

ISOLAMENTO TERMICO

L'interruzione del ponte termico sarà ottenuta da barrette continue in poliammide da 28 mm. totale e dovrà garantire un valore di trasmittanza termica per l'infisso $U_w = \dots\dots\dots$ W/m²K. L'assemblaggio dei profilati in alluminio a taglio termico dovrà garantire i valori di scorrimento (T) tra profilati in alluminio e barrette in poliammide previsti dalla direttiva tecnica Europea (UEAtc).

DRENAGGI E VENTILAZIONE

I profilati esterni delle ante mobili dovranno prevedere una gola ribassata per la raccolta delle acque di infiltrazione e di condensa onde poter permettere il libero deflusso delle stesse attraverso apposite asole di scarico. Le barrette in poliammide dovranno avere una conformazione geometrica atta ad evitare eventuale ristagno di acque di infiltrazione e di condensa ed essere perfettamente complanari con le pareti trasversali dei profilati di alluminio.

ACCESSORI DI ASSEMBLAGGIO

Le giunzioni tra profilati orizzontali e verticali dovranno essere perfettamente solidali e ben allineate tra di loro, sia nella parte esterna che interna dei profilati ed unite mediante apposite squadrette a bottone o, in alternativa, in alluminio estruso o pressofuso, con metodo a spino-cianfrinatura od a cianfrinatura totale. Le sezioni dei profilati orizzontali e verticali dovranno essere opportunamente sigillate prima di essere unite con le squadrette. I fermavetri saranno accoppiati a scatto e posizionati nei canali dei profilati in alluminio .

GUARNIZIONI

Tutte le guarnizioni: cingivetro, di tenuta, di battuta.... dovranno essere in elastomero (EPDM). In particolare la guarnizione di tenuta centrale (giunto aperto) dovrà assicurare la continuità perimetrale mediante l'impiego di angoli vulcanizzati preformati incollati alla stessa o in alternativa mediante telai vulcanizzati.

PRESTAZIONI

I serramenti dovranno avere prestazioni di permeabilità all'aria, tenuta all'acqua e resistenza ai carichi del vento conformemente alle norme :
(UNI-EN 12207 - 12208 - 12210 e UNI-EN 1026 - 1027 - 12211)

Permeabilità all'aria : classe **4**
Tenuta all'acqua : classe **E 1200**
Resistenza al vento : classe **C 5**



CX 700 HP

HIGH PERFORMANCE

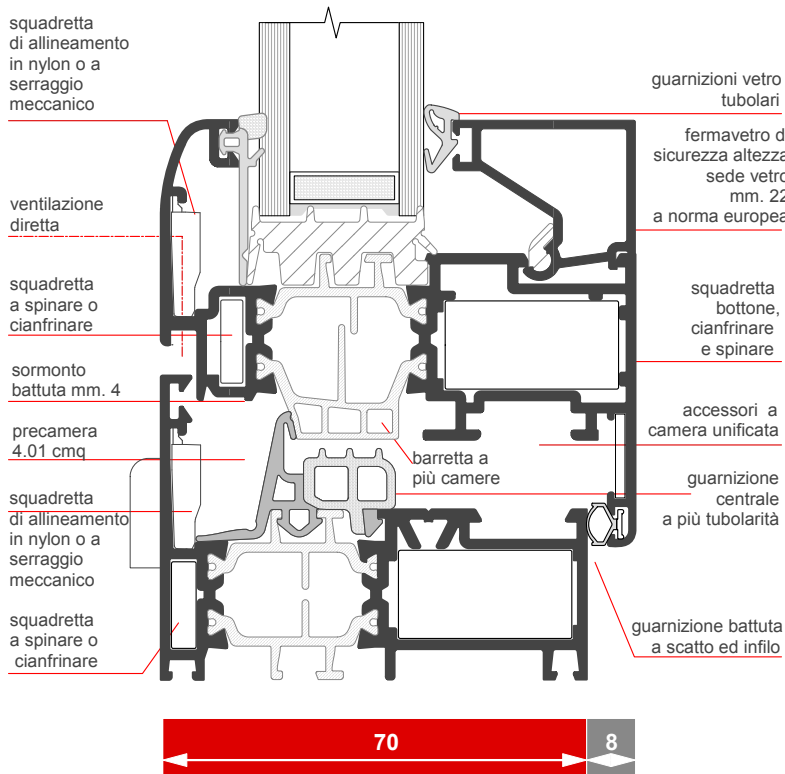

Schema dimensionale:

Telaio fisso :	mm. 70
Telaio mobile:	mm. 78 (complanare) secondo profilo
Barrette isolanti:	mm. 28 sia per telaio che anta
Fuga perimetrale :	mm. 5
Alloggiamento accessori:	a Camera Europea spazio 11.5 mm.
Giunzione angolare:	con squadrette a bottone, spinare o cianfrinare



Analisi termica con FLIXO vers.7 e WinIso2D Professional 7.8

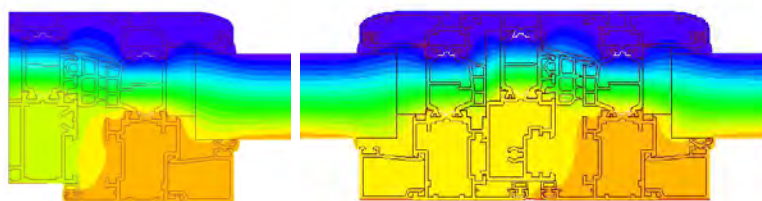

Risultati dei test/ CE product pass conforme ad UNI EN 14351-1:2006+A1:2010

Permeabilità all'aria:	Classe 4
Tenuta all'acqua:	Classe E 1200
Resistenza al carico di vento:	Classe C5
Isolamento acustico:	fino a 45 dB
Resistenza all'effrazione:	Classe RC 2

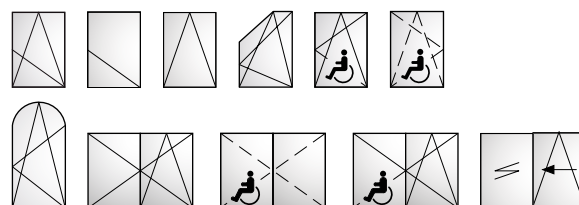

Caratteristiche tecniche:

Tecnologia:

- Sistema a camera multipla ad elevato isolamento termico con design simmetrico e qualità dell'assemblaggio garantita
- Spessore dei tamponamenti fino a 55 mm

Isolamento termico:

Serramento campione

- Valore U_w **1.33** W/(m²K)
con vetro camera $U_g = 1.0$ W/(m²K) certificato con canalina $\psi = 0.036$ W/(m²K) su finestra normalizzata con H = 1480 mm. ed L = 1535 mm.
- Valore U_w **0.97** W/(m²K)
con vetro triplo $U_g = 0.5$ W/(m²K) certificato con canalina $\psi = 0.031$ W/(m²K) su finestra normalizzata con H = 1480 mm. ed L = 1535 mm.

Dimensioni massime ammesse per il calcolo U_w su serramento campione fino a 2.3 mq (secondo norma UNI EN 14351-1:2006+A1:2010)

Ferramenta:

- Sistema con accessori funzionali a camera unificata, spazio 11.5 mm. personalizzati ed a pista 16 mm.
- giunzione angolare con squadrette a bottone/ spinare/cianfrinare ed allineamento

Impiego:

- Profilati per finestre che consentono la costruzione di infissi ad una, due o più ante a battente, nella versione a giunto aperto complanari all'esterno e a sormonto all'interno. Sono possibili anche specchiature fisse, wasistas, anta-ribalta. Profilati per porte: consentono la costruzione di porte ad una o due ante, apribili all'interno, con sopraluci fissi od apribili e vetrine



Agenti Atmosferici



Tenuta all'acqua* EN 1027 - EN 12208

Capacità di un infisso di impedire infiltrazioni quando è investito da un flusso d'acqua ed è presente una differente pressione tra interno ed esterno.

Pressione d'aria
Km/h
Classe

0Pa	50Pa	100Pa	150Pa	200Pa	250Pa	300Pa	450Pa	600Pa	750Pa	900Pa	1050Pa	1200Pa	1350Pa	1500Pa
0	32	45	55	64	72	78	96	111	126	138	149	159	169	178
-	1A	2A	3A	4A	5A	6A	7A	8A	E750	E900	E1050	E1200	E1350	E1500

L'infisso **TWIN**, con una pressione del vento pari ad una velocità di 159 Km/h (1200Pa) non ha avuto infiltrazioni

Classe Raggiunta
E 1200

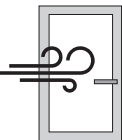

Permeabilità all'aria* EN 1026 - EN 12207

Caratteristica di un infisso chiuso di lasciare filtrare aria quando è presente una differenza di pressione tra l'interno e l'esterno; minori saranno i volumi dispersi, maggiore sarà la qualità del serramento.

Pressione Vento
Classe

150Pa	300Pa	450Pa	600Pa
1	2	3	4

L'infisso **TWIN** ha superato la prova con una pressione del vento pari ad una velocità di 111 Km/h (600Pa)

Classe Raggiunta
4

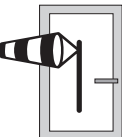

Resistenza al vento* EN 12211 - EN 12210

Capacità di un infisso sottoposto a forti pressioni e/o depressioni, come quelle causate dal vento, di mantenere una deformazione ammissibile, di conservare le proprietà iniziali a salvaguardia della sicurezza degli utenti.

Pressione d'aria
Flessione
Classe

400Pa	800Pa	1200Pa	1600Pa	2000Pa	>2000Pa
A (<1/150)	B (< 1/200)	C (< 1/300)			
1	2	3	4	5	Exxx

Classe Raggiunta
C5

*Serramento a 2 ante, dimensione L = mm.1488 ed H = mm.1667 - Certificato prova n° **RP n° 0970-CPD-RP0618** | Disponibili altre certificazioni



Potere fonoisolante EN ISO 140-3, EN ISO 717-1

Perdita di isolamento acustico rispetto al vetro DRw (dB) a partire dalla classe di permeabilità all'aria dell'infisso (UNI EN 12207)

Classe	1	2	3	4
Perdita	8dB	6dB	4dB	2dB

N.B. Per valori DRw < 38 db è ammesso l'utilizzo di questo metodo tabellare

Per valori DRw > 39 db in su è necessario realizzare un campione al vero e sottoporre a prove di Laboratorio.

Attenuazione
Rumori Esterni
Fino a
45 dB

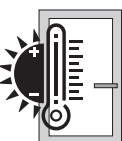

Trasmittanza Termica

Flusso di calore che passa attraverso il serramento per m² di superficie e per ogni grado di differenza di temperatura tra interno ed esterno.

Uw **1.33 W/m² K**

Finestra a 2 ante normalizzata (1535 mm. x 1480 mm; vetro camera Ug=1.0 W/m²K certificato con canalina psi=0.036 W/m K)

Uw **0.97 < W/m² K**

Finestra a 2 ante normalizzata (1535 mm. x 1480 mm; vetro triplo Ug=0.5 W/m²K certificato con canalina psi=0.031 W/m K)

Effrazione



Resistenza all'effrazione

Capacità di un infisso di resistere ad un'intrusione violenta a seguito di una applicazione di una forza fisica e con l'aiuto di attrezzi
Finestra a 2 ante (1230 mm. x 1480 mm) - CERTIFICATO CP384-VAL-3400A.52

Classe di resistenza	RC 1	RC 2	RC 3
	forza fisica (calci, pugni, spallate)	semplice attrezzatura (cunei, cacciaviti)	R2 + Piede di Porco

L'infisso **TWIN**, resiste in modo efficace ai tentativi di intrusione interna.

Resistenza
Effrazione
RC 2

Resistenze Meccaniche



Forze di azionamento EN 13115

Idoneità di un infisso di permettere una facile apertura con uno sforzo minimo

Classe Forza Applicata	0	1	2
------------------------	---	---	---

L'infisso **TWIN**, consente grande facilità di apertura con uno sforzo minimo.

Classe Raggiunta
1

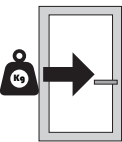

Resistenza meccanica EN 12046 - EN 13115

Capacità di un infisso di resistere ai carichi applicati senza rotture, deformazioni permanenti o torsioni tali da pregiudicare il suo corretto funzionamento.

Classe Carico Verticale Torsione Statica	1	2	3	4
	200 N	400 N	600 N	800 N

L'infisso **TWIN** resiste ai carichi applicati senza torsioni, deformazioni permanenti o rotture.

Classe Raggiunta
4

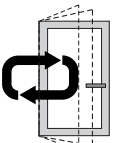

Resistenza ai cicli di apertura e chiusura EN 13126 - 4

Capacità di un infisso di resistere nel tempo a ripetuti cicli di apertura e chiusura.

Grado N° Cicli	3	4	5
	10'000	15'000	25'000

L'infisso **TWIN**, resiste efficacemente ai cicli di apertura e chiusura

Grado Resistenza
5



Resistenza all'urto (METODO DI PROVA CON CORPO DURO) EN 13049

Capacità di un infisso di resistere in caso di urti involontari o accidentali.

Classe Altezza Caduta	1	2	3	4	5
	200mm	300mm	450mm	700mm	950mm

L'infisso **TWIN**, resiste efficacemente agli urti.

Classe Raggiunta
1



Battente Una e Due Ante Cerniere
ACX.02.01 e ACX.02.03

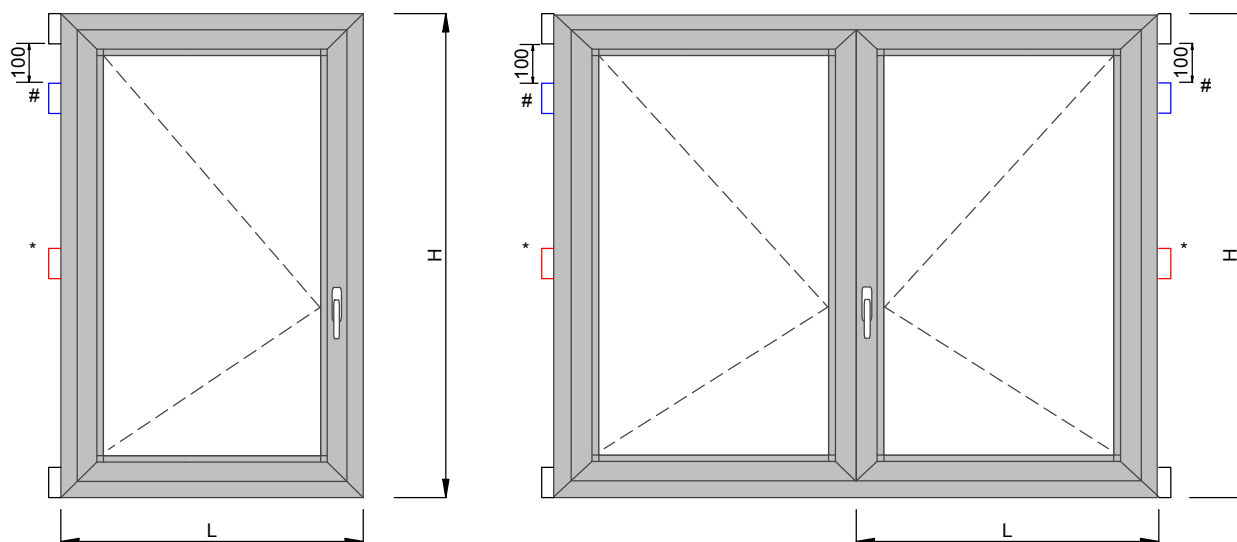

Dimensioni Anta Minima (LxH): 430 x 500

Norma per Stringa di Prodotto EN 1935:2004

Tipo	Categoria D'uso (1)	Durabilità (2)	Massa (3)	Resistenza Fuoco (4)	Sicurezza D'uso (5)	Resistenza Corrosione (6)	Resistenza Effrazione (7)	Grado Cerniera (8)
ACX.02.01	1	4	2 (80Kg)	0	1	4	0	6
ACX.02.03	1	4	3 (120Kg)	0	1	4	0	9

Dimensione Massime Anta (LxH)

Un Anta 2 Cerniere	Un Anta 3 Cerniere *	Un Anta 4 Cerniere *e#
1000x1600	1200x1800	1300x2100
Due Ante 2 Cerniere	Due Ante 3 Cerniere *	Due Ante 4 Cerniere *e#
1000x1500	1000x1700	1000x2100

Legenda Stringa di Prodotto

Categoria D'uso (1)	Durabilità (2) Cicli test	Massa (3) x cerniera	Resistenza Fuoco (4)	Sicurezza D'uso (5)	Resistenza Corrosione (6)	Resistenza Effrazione (7)	Grado Cerniera (8)
1:leggero	3:10.000	2: 40 Kg	0: non idoneo	1: soddisfatto	4: 240h in nebbia salina in accordo alla UNI EN 1670:2008	1	il suo valore è dato dalla combinazione di Massa e cicli
2:Medio	4:25.000	3: 60 Kg					
3:Pesante	7:200.000	4: 80 Kg	1: idoneo				
4:Intenso		5: 100 Kg					



Battente Una e Due Ante Cerniere a pettine
ACX.08.09

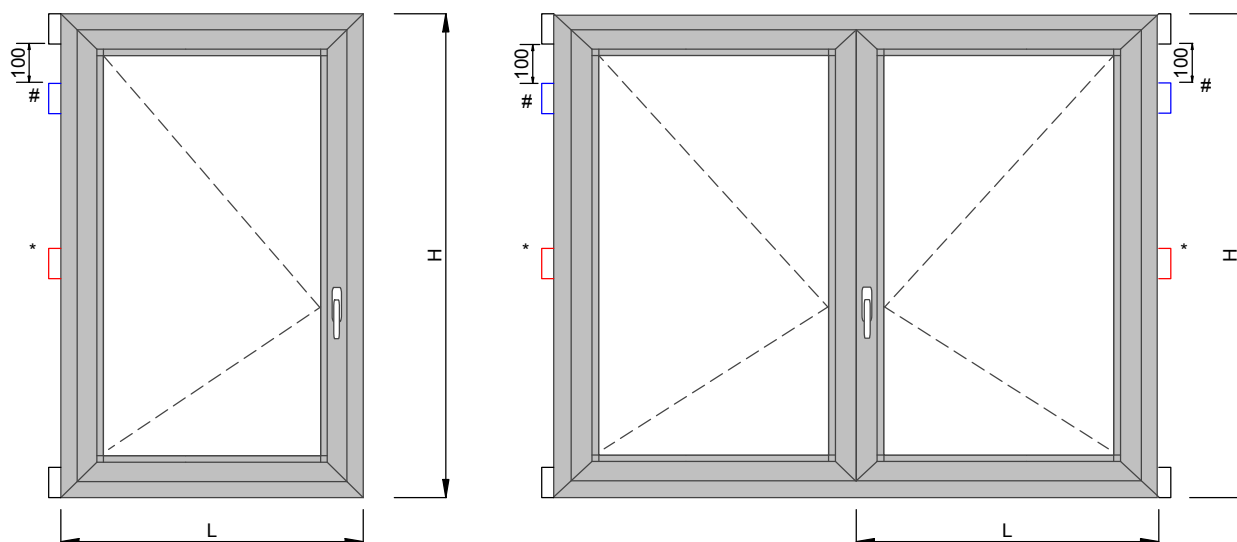

Dimensione Anta Minima (LxH): 430 x 500

Norma per Stringa di Prodotto EN 1935:2004

Tipo	Categoria D'uso (1)	Durabilità (2)	Massa (3)	Resistenza Fuoco (4)	SicurezzaD'uso (5)	Resistenza Corrosione (6)	Resistenza Effrazione (7)	Grado Cerniera (8)
ACX.08.09	2	7	2 (80Kg)	0	1	4	0	7

Dimensione Massime Anta (LxH)

Un Anta 2 Cerniere	Un Anta 3 Cerniere *	Un Anta 4 Cerniere *e#
1000x1600	1200x1800	1300x2100
Due Ante 2 Cerniere	Due Ante 3 Cerniere *	Due Ante 4 Cerniere *e#
1000x1500	1000x1700	1000x2100

Legenda Stringa di Prodotto

Categoria D'uso (1)	Durabilità (2) Cicli test	Massa (3) x cerniera	Resistenza Fuoco (4)	SicurezzaD'uso (5)	Resistenza Corrosione (6)	Resistenza Effrazione (7)	Grado Cerniera (8)
1:leggero	3:10.000	2: 40 Kg	0: non idoneo	1: soddisfatto	4: 240h in nebbia salina in accordo alla UNI EN 1670:2008	1	il suo valore è dato dalla combinazione di Massa e cicli
2:Medio	4.25.000	3: 60 Kg					
3:Pesante	7:200.000	4: 80 Kg	1: idoneo				
4:Intenso		5: 100 Kg					



Cerniere per Profili Porte Applicazione Esterna
ARX.02.12 (2 ali) e ARX.02.13 (3 ali)

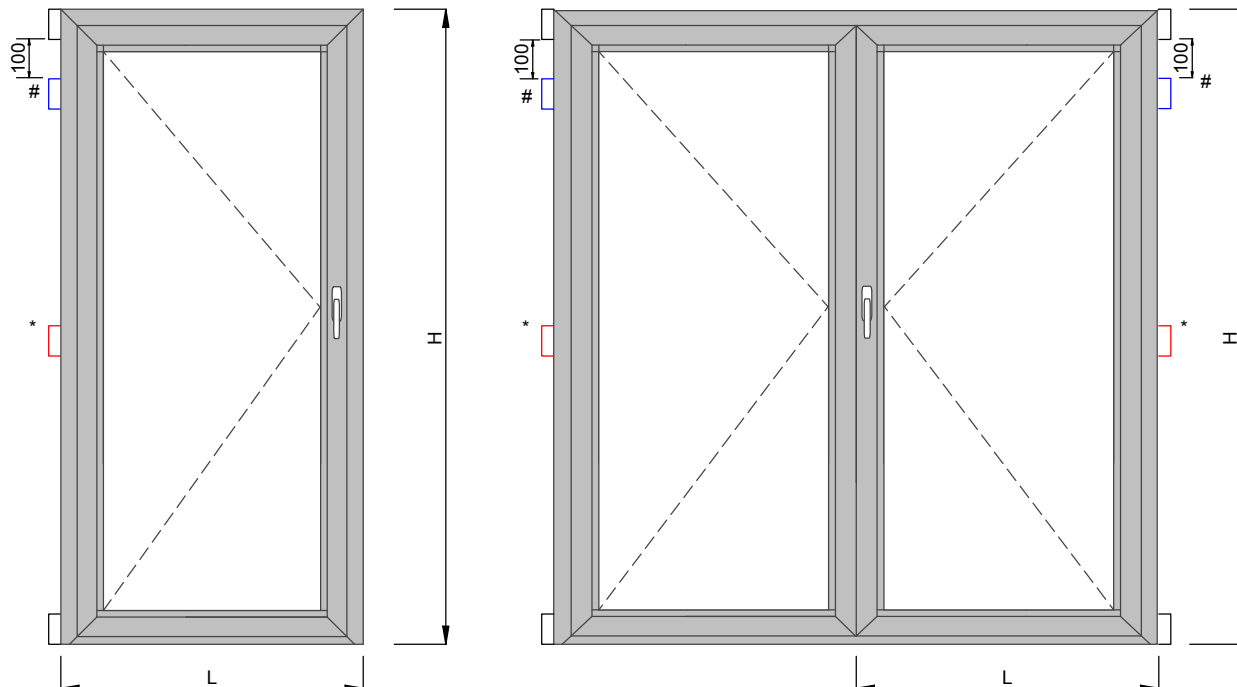

Norma per Stringa di Prodotto EN 1935:2004

Tipo	Categoria D'uso (1)	Durabilità (2)	Massa (3)	Resistenza Fuoco (4)	Sicurezza D'uso (5)	Resistenza Corrosione (6)	Resistenza Effrazione (7)	Grado Cerniera (8)
ARX.02.12	3	7	4 (160Kg)	0	1	4	0	11
ARX.02.13	3	7	5 (200Kg)	0	1	4	0	12

Dimensione Massime Anta (LxH)

Un Anta 2 Cerniere	Un Anta 3 Cerniere *	Un Anta 4 Cerniere *e#
1000x2200	1200x2200	1300x2200
Due Ante 2 Cerniere	Due Ante 3 Cerniere *	Due Ante 4 Cerniere *e#
800x2200	1000x2200	-

Legenda Stringa di Prodotto

Categoria D'uso (1)	Durabilità (2) Cicli test	Massa (3) x cerniera	Resistenza Fuoco (4)	Sicurezza D'uso (5)	Resistenza Corrosione (6)	Resistenza Effrazione (7)	Grado Cerniera (8)
1:leggero	3:10.000	2: 40 Kg	0: non idoneo	1: soddisfatto	4: 240h in nebbia salina in accordo alla UNI EN 1670:2008	1	il suo valore è dato dalla combinazione di Massa e cicli
2:Medio	4.25.000	3: 60 Kg					
3:Pesante	7:200.000	4: 80 Kg	1: idoneo				
4:Intenso		5: 100 Kg					

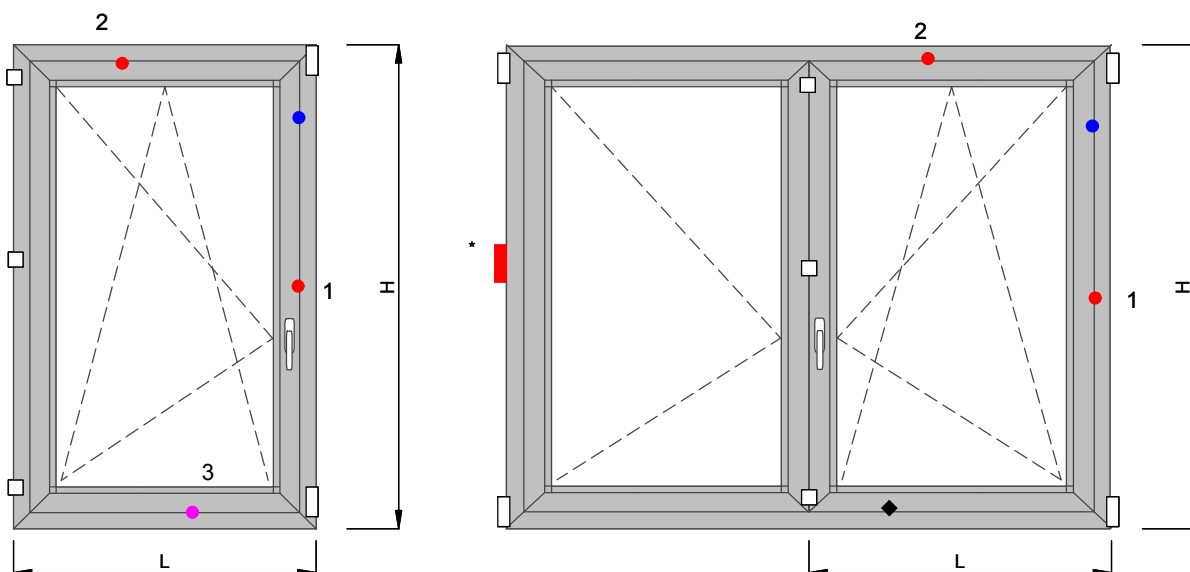
Aperture Oscillo battenti (140 Kg.) Una e Due Ante
ACX.08.01 e ACX.08.01 L

- Punti di chiusura su Kit base **ARX.08.01**
- ◆ □ Punti di chiusura su Kit base **ARX.08.01 L**
- Punti di chiusura supplementari **ARX.08.06**
- Punti di chiusura supplementari **ARX.08.16**
- Punti di chiusura supplementari **ARX.08.16**

Norma per Stringa di Prodotto UNI EN 13126-8:2006

Tipo	Categoria D'uso (1)	Durabilità (2)	Massa (3)	Resistenza Fuoco (4)	Sicurezza D'uso (5)	Resistenza Corrosione (6)	Resistenza Effrazione (7)	Applicazione (8)	Dimensione di prova (9)
ACX.08.01	-	4	(140Kg)	0	1	4	-	8	1550x1400
ACX.08.01L	-	4	(140Kg)	0	1	4	-	8	1550x1400

Braccio corto ACX.08.22 e ACX.08.22L

	Anta Singola LxH	Anta Doppia LxH	Punti di chiusura
Dimensioni Min	395x500	395x500	ACX.08.01 - ACX.08.01L
Dimensioni Max	450x500	450x500	ARX.08.01 - ARX.08.01L

Braccio Medio ACX.08.03 e ACX.08.22L

	Anta Singola LxH	Anta Doppia LxH	Punti di chiusura
Dimensioni Min	451x500	445x500	ACX.08.01 - ACX.08.01L
Dimensioni Max	650x1200	650x1200	KIT + ACX.08.06
Dimensioni Max	650x2200	650x2200	KIT + ACX.08.06 + ACX.08.16

Braccio Lungo ACX.08.24 e ACX.08.24L

	Anta Singola LxH	Anta Doppia LxH	Punti di chiusura
Dimensioni Min	651x600	651x600	ACX.08.01 - ACX.08.01L
Dimensioni Max	651x1400	651x1400	ACX.08.01 + ACX.08.06
Dimensioni Max	651x2200	651x2200	KIT + ACX.08.06 + ACX.08.16
Dimensioni Max	1200x1400	1200x1400	KIT+ ACX.08.06 + ACX.08.16 (n°2)
Dimensioni Max	1200x2200	1200x2200	KIT + ACX.08.06 + ACX.08.16 (n°3)
Dimensioni Max	1200x1400	-	KIT + ACX.08.06 + ACX.08.16 (n°3)
Dimensioni Max	1200x2200	-	-

Legenda Stringa di Prodotto

Categoria D'uso (1)	Durabilità (2) Cicli	Massa (3)	Resistenza Fuoco (4)	Sicurezza D'uso (5)	Resistenza Corrosione (6)	Resistenza Effrazione (7)	Applicazione (8)	Dimensione di prova (9)
-	4:15.000 a/r+5.000 battente	Portata Certificazione	0: non idoneo	1: Soddisfatto	4: 240h UNI EN 1670:2008	-	8: Privato	Dimensione Campione di prova

LIMITI IMPIEGO DEL SISTEMA

TIPOLOGIA		PROFILI									
	CX70.201HP Jx 37.73 cm ⁴ Wx 9.46 cm ³ Jy 9.96 cm ⁴ Wy 2.80 cm ³		CX70.202HP Jx 51.50 cm ⁴ Wx 13.13 cm ³ Jy 31.00 cm ⁴ Wy 6.51 cm ³								
			CX70.203HP Jx 42.53 cm ⁴ Wx 9.93 cm ³ Jy 14.47 cm ⁴ Wy 3.76 cm ³			CX70.206HP Jx 56.75 cm ⁴ Wx 13.79 cm ³ Jy 39.71 cm ⁴ Wy 783 cm ³					
			CX70.204HP Jx 47.57 cm ⁴ Wx 11.87 cm ³ Jy 14.63 cm ⁴ Wy 3.71 cm ³								
			Pressione del vento (Pa) : 1200 Pascal				Dimensione Minima	Dimensione Massima	Dimensione Minima	Dimensione Massima	
			Finestra ad 1 anta	L anta (mm)		430	1200	430	1500		
				H anta (mm)		700	1700	750	1900		
	Porta balcone ad 1 anta	L anta (mm)	430	1200	430	1200					
		H anta (mm)	750	2000	750	2400					

TIPOLOGIA		PROFILI									
	RX70.201HP Jx 38.05 cm ⁴ Wx 9.49 cm ³ Jy 10.07 cm ⁴ Wy 2.70 cm ³		RX70.202HP Jx 50.61 cm ⁴ Wx 12.79 cm ³ Jy 30.43 cm ⁴ Wy 6.15 cm ³								
			RX70.203HP Jx 42.59 cm ⁴ Wx 9.97 cm ³ Jy 14.72 cm ⁴ Wy 3.64 cm ³			RX70.206HP Jx 55.73 cm ⁴ Wx 13.74 cm ³ Jy 39.26 cm ⁴ Wy 7.44 cm ³					
			RX70.204HP Jx 48.26 cm ⁴ Wx 12.00 cm ³ Jy 14.49 cm ⁴ Wy 3.69 cm ³								
			Pressione del vento (Pa) : 1200 Pascal				Dimensione Minima	Dimensione Massima	Dimensione Minima	Dimensione Massima	
			Finestra ad 2 anta	L anta (mm)		430	1000	430	1200		
				H anta (mm)		700	1600	750	1800		
	Porta balcone ad 2 anta	L anta (mm)	430	1000	430	1200					
		H anta (mm)	750	2000	750	2300					



LA MARCATURA CE DELLE FINESTRE E PORTE PEDONALI SENZA CARATTERISTICHE DI RESISTENZA AL FUOCO E/O DI TENUTA AL FUMO

Il marchio **CE**, apposto sui prodotti da costruzione, attesta la loro conformità ai requisiti essenziali definiti dalla direttiva 89/106/CE "Prodotti da costruzione", emanata dal Consiglio della Comunità Europea il 21/12/1988 ed attuata, in Italia, dal D.P.R. n. 246 del 21/04/1993.

La marcatura CE di uno specifico prodotto da costruzione diviene obbligatoria, al fine di immettere il prodotto in un mercato della Comunità Europea, allorché sia stata emessa dal CEN, su mandato della Comunità Europea, una "specificazione tecnica" (norma o benessere tecnico) che regolamenti la sua applicazione.

La responsabilità per la verifica dei requisiti del prodotto e per l'apposizione della marcatura CE spetta al suo fabbricante.

Al fine di garantire i requisiti richiesti dalle relative norme, il fabbricante è tenuto a:

- predisporre un piano di controllo della produzione (FPC). E' un sistema di procedure e controlli da eseguire durante le fasi di produzione;
- effettuare delle "prove iniziali di tipo" (ITT) sul prodotto al fine di determinare le prestazioni. Le modalità di prova dei requisiti del prodotto sono definite dalle norme richiamate dalla specifica norma prodotto".

Alcune prove possono essere eseguite dal produttore stesso, secondo le disposizioni delle relative norme armonizzate, mentre altri requisiti sono di competenza di laboratori in possesso di una notifica attribuita loro dallo stato membro di appartenenza (organismi notificati).

***Il fabbricante può procedere in più modi:
 eseguire autonomamente i test sui propri prodotti presso un istituto Notificato, diventando quindi titolare degli ITT
 far riferimento ai risultati di prove effettuate dal detentore del sistema di serramento, purché quest'ultimo abbia espresso il proprio consenso per mezzo di un contratto di licenza d'uso stipulato tra le parti.***

Dal mese di Febbraio 2010 è obbligatoria la marcatura CE per finestre e porte pedonabili senza caratteristiche di resistenza al fuoco e tenuta al fumo.

L'appendice ZA della norma UNI EN 14351-1 specifica le caratteristiche essenziali per finestre e porte e attribuisce le competenze delle prove iniziali di tipo.

Per finestre e porte senza funzione di compartimentazione del fuoco o fumo e non poste nelle vie di fuga (sistema di attestazione della conformità 3):

Caratteristiche essenziali	Espressioni delle prestazioni	Competenza Prove Iniziali Tipo		
		ON =Organismo Notificato ; PR= Produttore		
		Finestre	Porte	Lucernari
Comportamento al fuoco dall'esterno				ON
Reazione al fuoco	Euroclassi			ON
Tenuta all'acqua	Classi tecniche	ON	ON	ON
Sostanze pericolose		ON	ON	
Resistenza al carico del vento	Classi tecniche	ON	ON	PR
Resistenza al carico della neve e al carico permanente	KN/mq			PR
Resistenza all'urto	Classi tecniche		PR	ON
Capacità portante dei dispositivi di sicurezza	Soglia	ON	ON	ON
Altezza	mm.		PR	
Forze di azionamento (solo dispositivi automatici)	Classi tecniche		ON	
Prestazione acustica	dB	ON	ON	ON
Trasmittanza termica	W/mqK	ON	ON	ON
Proprietà radioattive				PR
Permeabilità all'aria	Classi tecniche	ON	ON	ON



Il requisito relativo ad una determinata caratteristica non è applicabile in quegli Stati Membri nei quali non sussistono requisiti di regolamentazione per tale caratteristica per l'impiego previsto del prodotto. In questo caso, i fabbricanti che immettono i loro prodotti sul mercato di questi Stati membri non sono obbligati a determinare né a dichiarare le prestazioni dei loro prodotti in relazione a questa caratteristica e può essere utilizzata l'opzione "Nessuna Prestazione Determinata" (NPD) nelle informazioni che accompagnano la marcatura CE (vedere punto ZA.3). Tuttavia, l'opzione NPD non può essere utilizzata nel caso in cui la caratteristica sia soggetta a un livello soglia.

(Citazione integrale tratta dalla norma UNI EN 14351-1 - appendice ZA)

Pertanto, la valutazione delle caratteristiche da dichiarare è funzione della destinazione d'uso del prodotto e della legislazione vigente nello Stato Membro, ove esso è immesso.

TEST INIZIALI DI TIPO EFFETTUATI SULLE FINESTRE

La serie riportata nel presente catalogo è stata sottoposta a test iniziali di tipo (ITT) relativamente ai requisiti previsti dalla norma prodotto UNI EN 14351-1

I risultati dei test iniziali di tipo sono estendibili a serramenti di differente tipologia e con differenti dimensioni e componenti, secondo le indicazioni fornite dalla norma EN 14351-1 in Appendice A (interdipendenza fra le caratteristiche e i componenti), Appendice E (determinazione delle caratteristiche) ed Appendice F (selezione facoltativa di provini rappresentativi per le finestre)

Il costruttore di serramenti ha la responsabilità di verificare la rispondenza del serramento prodotto rispetto al campione sottoposto a prova.

Il consorzio TWIN Systems mette a disposizione dei propri clienti i risultati dei test effettuati, a seguito della stipulazione di un contratto d'uso gratuito degli stessi.

Dichiarazione di Conformità

Il fabbricante del serramento è tenuto a consegnare al committente una dichiarazione di conformità la quale, in accordo alla norma UNI EN 14351-1, deve includere :

Nome ed indirizzo del fabbricante o del suo rappresentante autorizzato con sede nella EEA;

Descrizione del prodotto (tipo, identificazione, impiego, ecc.) e una copia delle informazioni che accompagnano la marcatura CE;

Disposizioni alle quali il prodotto è conforme (appendice AZ della norma prodotto UNI EN 14351-1);

Condizioni particolari applicabili all'impiego del prodotto (per esempio disposizioni per l'impiego in determinante condizioni, ecc.);

Nome e indirizzo del/i laboratorio/i approvato/i.

Nome e qualifica della persona incaricata di firmare la dichiarazione per conto del fabbricante o del suo rappresentante autorizzato.

La dichiarazione e il certificato devono essere presentati nella lingua o nelle lingue ufficiali dello Stato Membro in cui il prodotto deve essere utilizzato.

Etichettatura e Marcatura

Il fabbricante deve fornire informazioni sufficienti ad assicurare la rintracciabilità del suo prodotto fornendo il collegamento fra il prodotto, il fabbricante e la produzione. Queste informazioni devono essere contenute su un'etichetta o specificate in documenti di accompagnamento nelle specifiche tecniche pubblicate dal fabbricante.

Le informazioni seguenti devono accompagnare il simbolo di marcatura CE:

Nome e indirizzo registrato o marchio di identificazione del fabbricante;

Ultime due cifre dell'anno in cui la marcatura CE è stata applicata;

Riferimento alla norma di prodotto (EN 14351-1);

Descrizione del prodotto: nome generico, materiale, dimensioni, ecc. e impiego previsto;

Informazioni sulle caratteristiche essenziali che devono essere dichiarate presentate come:

Valori dichiarati o livelli e/o classi;

NPD -" Nessuna prestazione determinata" per le caratteristiche quando è pertinente.

Il simbolo della marcatura CE e le informazioni di accompagnamento devono essere apposti in modo visibile, leggibile e indelebile in una o più delle posizioni seguenti (gerarchia di preferenza del fabbricante):

Qualsiasi parte idonea del prodotto stesso, purché sia assicurata la visibilità quando si aprono le ante;

Su un'etichetta attaccata;

Sul suo imballaggio;

Sul documento commerciale di accompagnamento.



Documentazione Tecnica di Accompagnamento

Il fabbricante deve fornire informazioni su quanto segue:

Immagazzinaggio e movimentazione, se il fabbricante non è responsabile dell'installazione del prodotto;

Requisiti e tecniche d'installazione (sul posto), se il fabbricante non è responsabile dell'installazione del prodotto (Guida UNCSAAL);

Manutenzione e pulizia (Manuale Consorzio TWIN SYSTEMS)

Istruzioni d'uso finali incluse le istruzioni per la sostituzione di componenti;

Istruzioni per l'uso in condizioni di sicurezza.

In Italia i requisiti obbligatori per la Marcatura CE sono:

Permeabilità dell'aria;

Trasmittanza termica;

Proprietà radiative (Fattore solare g, Trasmissione luminosa (TV)).

In Spagna e in Portogallo i requisiti obbligatori per la Marcatura CE sono :

Permeabilità all'aria;

Tenuta all'acqua;

Resistenza al vento;

Trasmittanza termica;

Isolamento acustico.

TRASMITTANZA TERMICA DEI SERRAMENTI

E' necessario sapere che le prescrizioni dettate dal decreto ministeriale cambiano in funzione della tipologia di intervento edilizio (nuova costruzione, ristrutturazione importante di primo oppure secondo livello, riqualificazione energetica) e si applicano ad edifici sia pubblici sia privati.

Per edifici di **nuova costruzione** si intendono quei fabbricati il cui titolo abilitativo sia stato richiesto dopo l'entrata in vigore del decreto.

Sono **assimilati agli edifici di nuova costruzione** gli edifici sottoposti a **demolizione e ricostruzione**, qualunque sia il titolo abilitativo necessario, e gli ampliamenti di edifici esistenti la cui nuova porzione abbia un volume lordo climatizzato superiore al 15% di quello esistente o comunque superiore a 500 m³.

Per **interventi di ristrutturazione importante di primo livello** si intendono quelli che interessano l'involucro edilizio con un'incidenza superiore al 50 per cento della superficie disperdente lorda complessiva dell'edificio, comprendendo anche la ristrutturazione dell'impianto termico per il servizio di climatizzazione invernale e/o estiva asservito all'intero edificio.

Per **interventi di ristrutturazione importante di secondo livello** si intendono quelli che interessano l'involucro edilizio con un'incidenza superiore al 25 per cento della superficie disperdente lorda complessiva dell'edificio e possono interessare l'impianto termico per il servizio di climatizzazione invernale e/o estiva.

Negli **interventi di riqualificazione energetica** rientrano gli interventi non riconducibili agli interventi succitati e che hanno un impatto sulla prestazione energetica dell'edificio. Rientrano quindi anche:

- le ristrutturazioni che interessano l'involucro edilizio con un'incidenza inferiore o uguale al 25 per cento della superficie disperdente lorda complessiva dell'edificio e/o consistono nella nuova installazione, nella ristrutturazione di un impianto termico asservito all'edificio o di altri interventi parziali, ivi compresa la sostituzione del generatore;
- gli ampliamenti di edifici esistenti la cui nuova porzione abbia un volume lordo climatizzato inferiore o uguale al 15% di quello esistente o comunque inferiore a 500 m³.

Per gli edifici di nuova costruzione e per quelli sottoposti a ristrutturazioni di primo livello, non sono previsti specifici limiti di trasmittanza termica da rispettare per le chiusure trasparenti. Sussiste l'obbligo di rispettare limiti per quanto concerne altri parametri tecnici che connotano gli impianti, l'involucro edilizio e l'edificio nel loro complesso (per esempio coefficiente medio globale di scambio termico per trasmissione per unità di superficie disperdente HT' - area solare equivalente estiva per unità di superficie utile Asol,est/Asup utile - indice di prestazione termica utile per riscaldamento EPH,nd - indice di prestazione termica utile per il raffrescamento EPC,nd - indice di prestazione energetica globale dell'edificio EPgl,tot, ecc.) contenuti nell'Allegato A del decreto.



I limiti dell'Allegato A sul coefficiente medio globale di scambio termico per trasmissione per unità di superficie disperdente HT' sono da rispettare anche per gli interventi di ristrutturazione importante di secondo livello.

Nell'ambito degli **interventi di ristrutturazione importante di secondo livello e degli interventi di riqualificazione energetica** sono invece da rispettare i limiti riportati nell'**Appendice B** del decreto relativamente:

- **alla trasmittanza termica U_w dei serramenti** (trasparenti, opachi) e **dei cassonetti** posti a delimitazione di ambienti climatizzati verso l'esterno oppure verso ambienti non climatizzati (cfr. **tabella 1**);
- **al fattore di trasmissione solare totale g_{gl+sh} dei serramenti vetrati in combinazione con schermature solari mobili** posizionati sui fronti dell'edificio SUD, EST, OVEST, SUD-EST, SUD-OVEST (cfr. **tabella 2**).

Tabella/Table 1

Valori limite della trasmittanza U_w dei serramenti (trasparenti, opachi) e dei cassonetti posti a delimitazione di ambienti climatizzati verso l'esterno oppure verso ambienti non climatizzati.

ZONA CLIMATICA	U_w [W/m ² K]	
	2021	ECOBONUS
Zona A	3.00	2.60
Zona B	3.00	2.60
Zona C	2.00	1.75
Zona D	1.80	1.67
Zona E	1.40	1.30
Zona F	1.00	1.00

Tabella/Table 2

Valori limite del fattore di trasmissione solare totale g_{gl+sh} chiusure trasparenti in presenza di schermature solari mobili installate su fronti dell'edificio SUD, EST, OVEST, SUD-EST, SUD-OVEST

ZONA CLIMATICA CLIMATIC ZONE	g_{gl+sh}
	2021
Zone TUTTE ALL ZONES	0.35

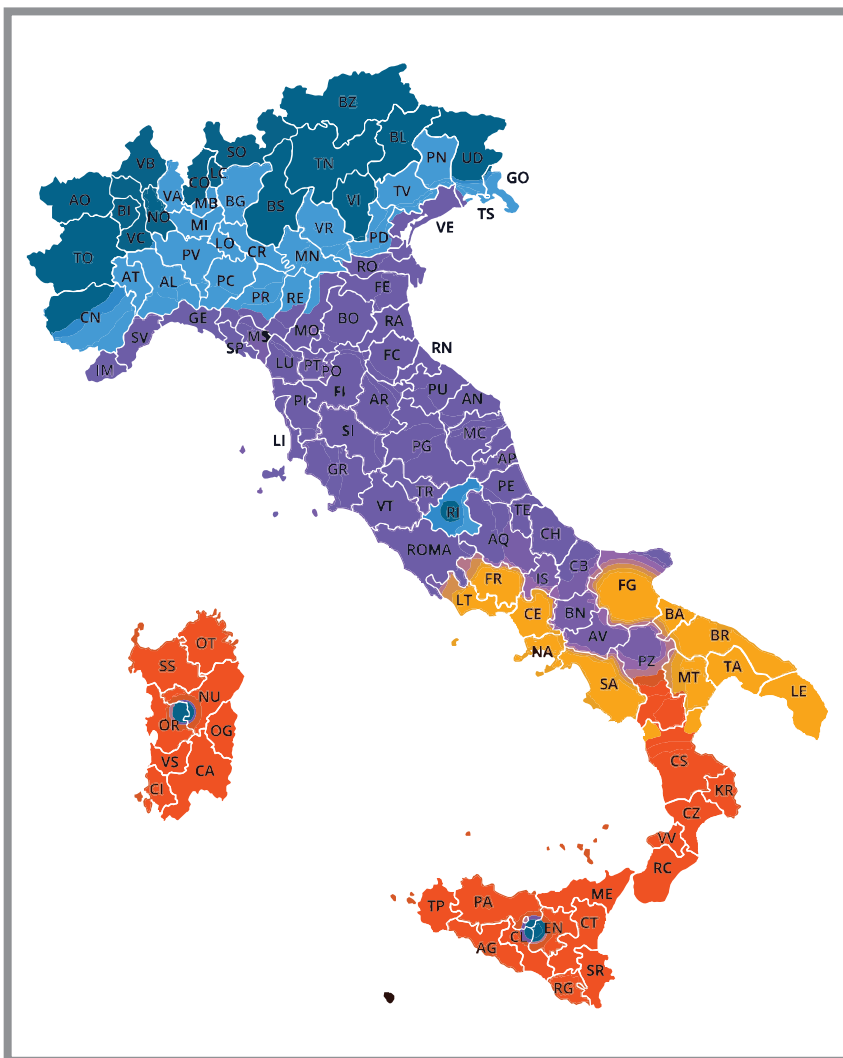



Valutazione della prestazione termica posseduta dai serramenti.

La trasmittanza termica rappresenta il parametro più significativo per la valutazione del comportamento termico di un prodotto edilizio: minore è il suo valore migliore è la prestazione termica posseduta dal componente stesso.

Il calcolo semplificato della trasmittanza termica del componente finestrato U_w composta da un singolo serramento e relativo vetro (o pannello) si esegue con la formula:

$$U_w = \frac{A_g U_g + A_f U_f + l_g \varnothing_g}{A_g + A_f}$$

dove:

A_g è l'area del vetro in mq;

U_g è il valore di trasmittanza termica riferito all'area centrale della vetrata, e non include l'effetto del distanziatore del vetro lungo il bordo della vetrata stessa;

A_f è l'area del telaio;

U_f è il valore di trasmittanza termica del telaio applicabile in assenza della vetrata;

l_g è la lunghezza del perimetro del vetro;

\varnothing_g è il valore di trasmittanza termica lineare concernente la conduzione di calore supplementare che avviene a causa dell'interazione tra telaio, vetri e distanziatore dei vetri in funzione delle proprietà termiche di ognuno di questi componenti e si rileva, secondo quanto precisato nell'allegato E della norma UNI EN ISO 10077-1, preferibilmente con il calcolo numerico eseguito in accordo con la norma ISO 10077-2; quando non sono disponibili i risultati di calcolo dettagliati ci si può riferire ai prospetti E.1 ed E.2 i quali indicano i valori \varnothing_g di default per le tipiche combinazioni di telai, vetri e distanziatori.

Estendibilità

L'appendice F della norma di prodotto UNI EN 14351-1 suggerisce le tipologie di serramento rappresentative e le relative estensioni, ma essendo la tabella puramente informativa, sta allo stesso produttore scegliere i campioni.

Tipo di finestre	Estensione possibile
Fisso	
Finestra ad una anta (apertura interna o esterna)	Finestra ad anta ribalta
Finestra ad anta ribalta	
Finestra ad due o più ante (apertura interna o esterna)	Finestra ad due o più ante
Finestra a una o due ante orizzontali scorrevoli	
Finestra a due ante orizzontali scorrevoli	Finestra a due ante orizzontali scorrevoli
Finestra a una o due ante orizzontali scorrevoli con ribalta	Finestra a una o due ante orizzontali scorrevoli con ribalta
Bilico orizzontale o verticale	Bilico orizzontale o verticale
Finestra a soffietto	Finestra a soffietto

La norma UNI EN 14351-1 prevede che il calcolo effettuato su di un serramento aventi dimensioni:

1230 ($\pm 25\%$) x 1480 (-25%)

1480 ($+25\%$) x 2180 ($\pm 25\%$)

Le analisi termiche effettuate con le misure sopra descritte, possono essere estese a tutti i serramenti di tutte le dimensioni, purché il vetro utilizzato abbia come valore di U_g uguale o inferiore a $1.9 \text{ w/m}^2\text{K}$, altrimenti la norma delle regole di estensione dei valori calcolati sull'infisso normalizzato ad infissi di diverse dimensioni.

Ovviamente i calcoli devono essere effettuati sulle stesse tipologie di infissi, e s'intende che una modifica del componente modifica la caratteristica in questione. In termini di prestazioni termiche è ovvio che andando a togliere o ad aggiungere elementi (per esempio passare da una finestra ad una anta, ad una a due e così via), determina una variazione dei valori finali.



Altezza [m]

Diagramma dei limiti di impiego per infissi a 2 ante deflessione del nodo centrale

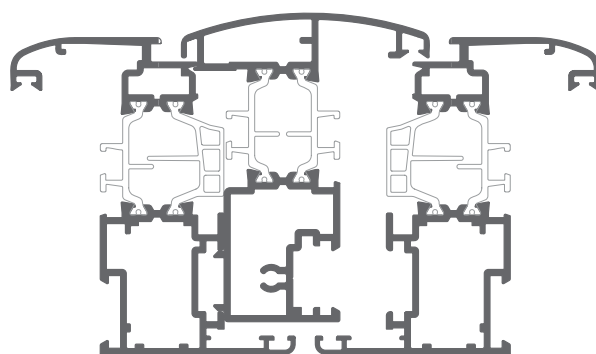
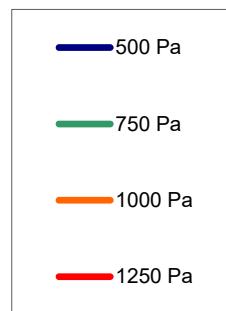
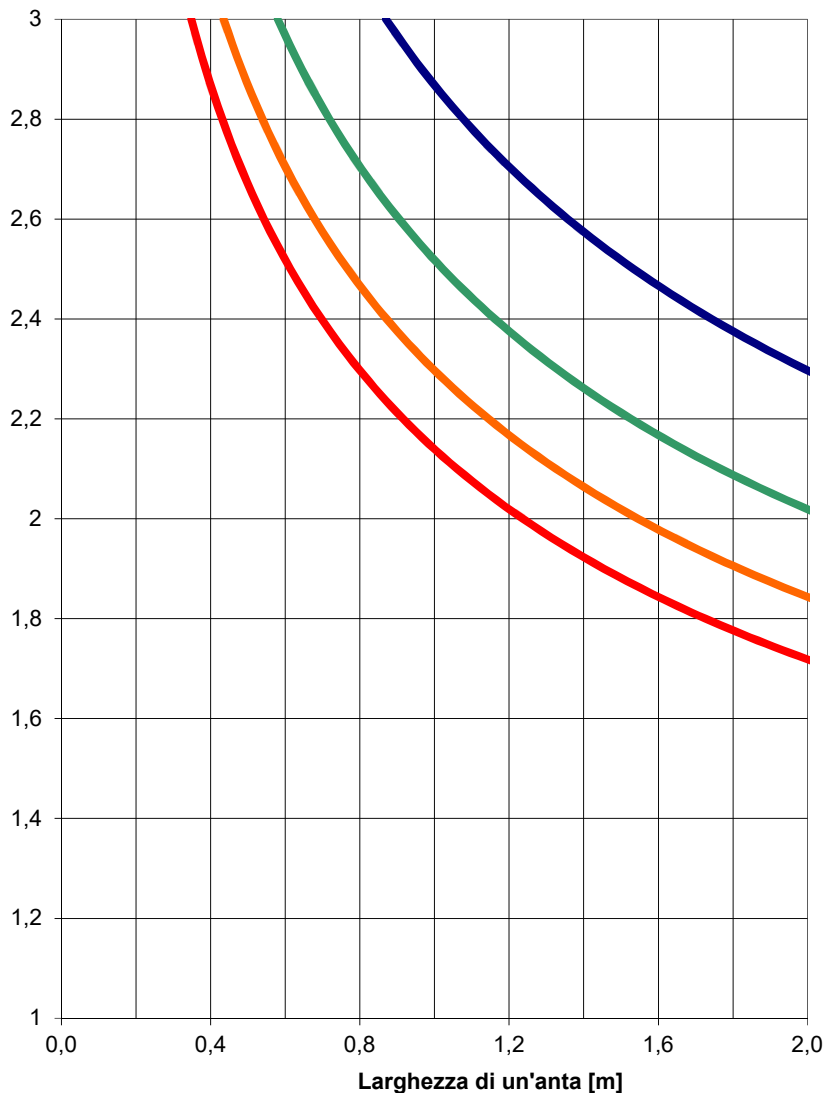

CX70.201HP + CX70.301HP + CX70.201HP

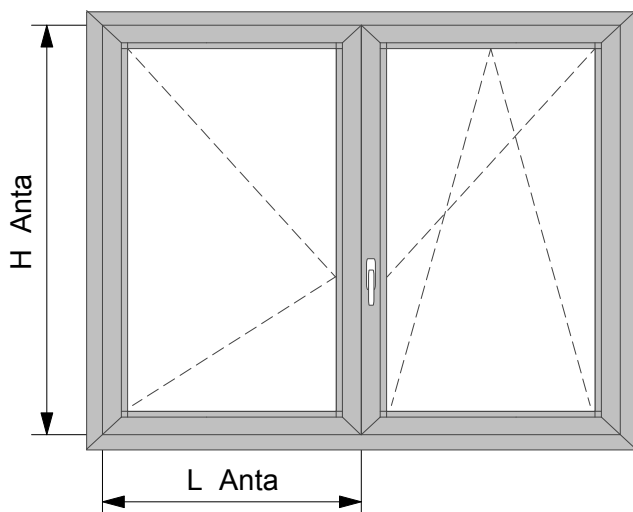

Il dimensionamento risultante dal grafico è solo indicativo.

Il progettista o il serramentista, nel determinare le dimensioni massime dei serramenti, dovrà considerare e valutare, oltre le dimensioni ed il momento d'inerzia dei profilati, anche le caratteristiche applicative e meteorologiche quali l'altezza dal suolo, l'esposizione alla pioggia e la velocità dei venti nella zona. Per questi dati consigliamo di consultare e seguire le "Raccomandazioni UNCSAAL" elaborate sulla base delle norme UNI, UNI-EN e UNI-CNR esistenti in merito.

Verificare che la freccia del profilato sia compatibile con quella del vetro utilizzato.

Le curve rappresentano la larghezza massima dell'anta in funzione della sua altezza e della pressione del vento.

Il serramento è considerato a 2 ante uguali.

Le curve sono calcolate sulla base della deformazione elastica di **1/300** dell'altezza del serramento.



Altezza [m]
**Diagramma dei limiti di impiego per infissi a 2 ante
deflessione del nodo centrale**

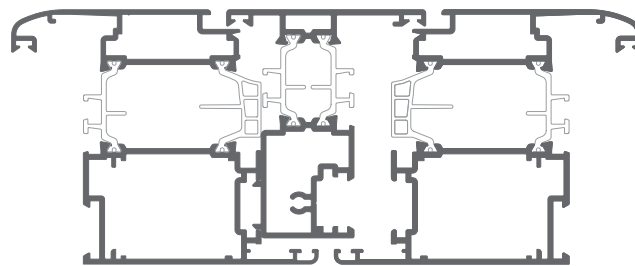
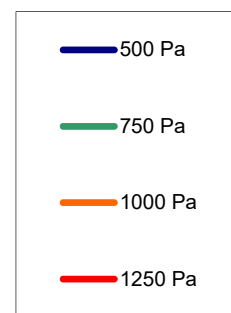
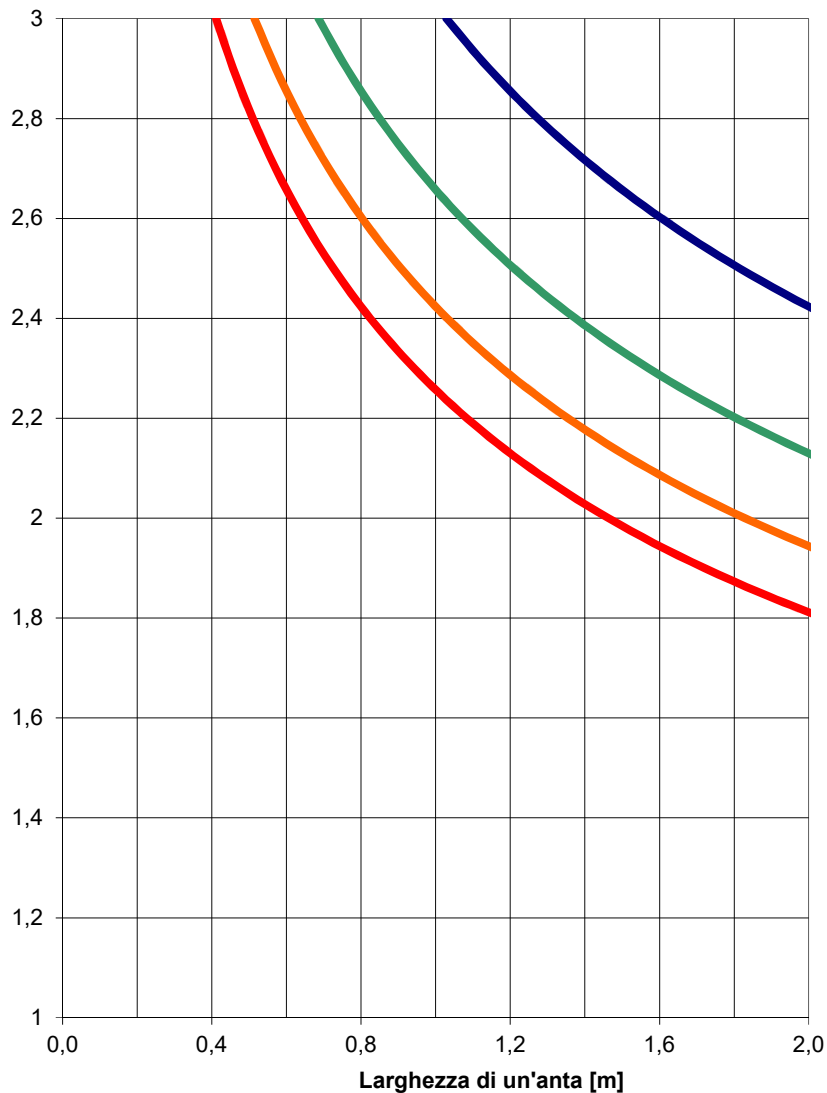

CX70.202HP + CX70.304HP + CX70.202HP

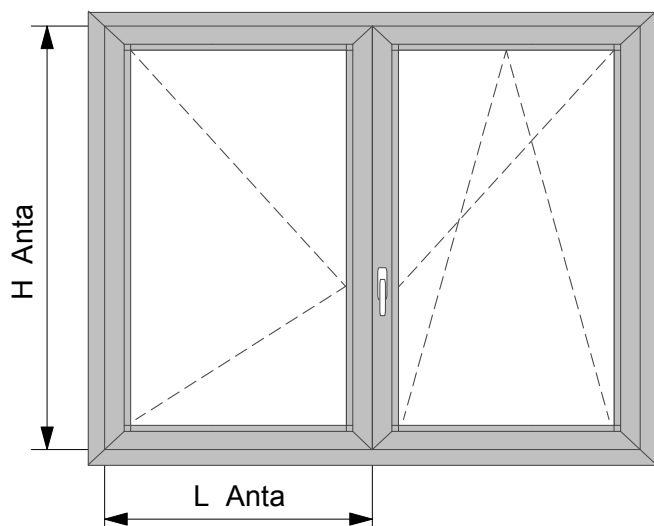

Il dimensionamento risultante dal grafico è solo indicativo.

Il progettista o il serramentista, nel determinare le dimensioni massime dei serramenti, dovrà considerare e valutare, oltre le dimensioni ed il momento d'inerzia dei profilati, anche le caratteristiche applicative e meteorologiche quali l'altezza dal suolo, l'esposizione alla pioggia e la velocità dei venti nella zona. Per questi dati consigliamo di consultare e seguire le "Raccomandazioni UNCSAAL" elaborate sulla base delle norme UNI, UNI-EN e UNI-CNR esistenti in merito.

Verificare che la freccia del profilato sia compatibile con quella del vetro utilizzato.

Le curve rappresentano la larghezza massima dell'anta in funzione della sua altezza e della pressione del vento.

Il serramento è considerato a 2 ante uguali.

Le curve sono calcolate sulla base della deformazione elastica di **1/300** dell'altezza del serramento.



Altezza [m]

Diagramma dei limiti di impiego per infissi a 2 ante
deflessione del nodo centrale

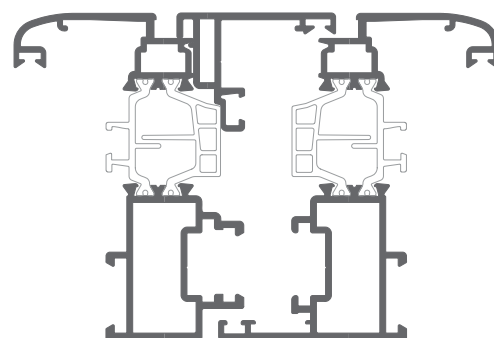
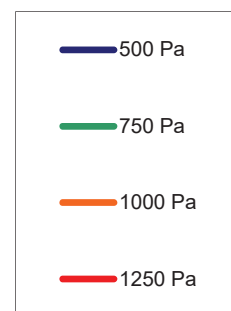
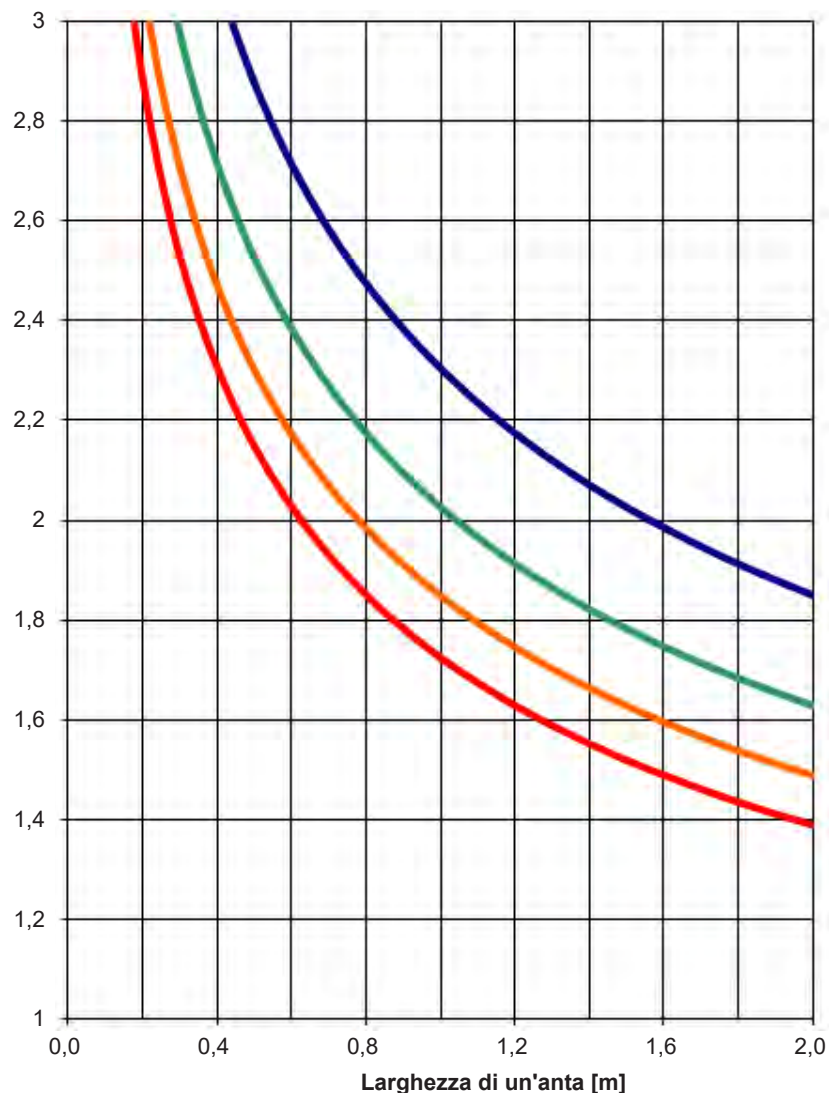

CX70S.201RHP + CX60S.304 + CX70S.201HP

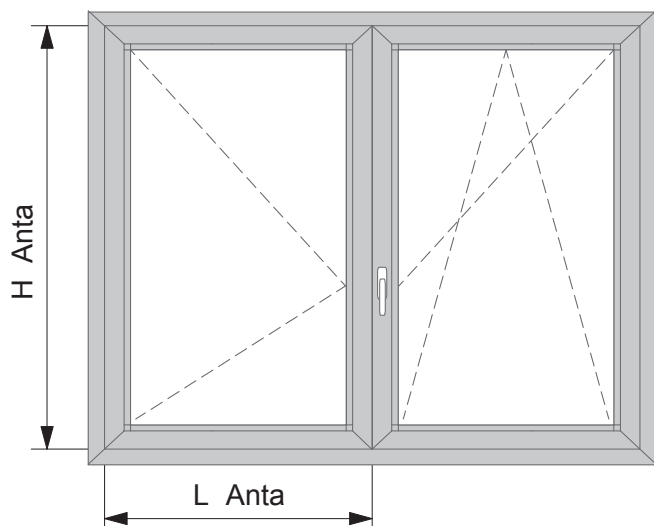

Il dimensionamento risultante dal grafico è solo indicativo.

Il progettista o il serramentista, nel determinare le dimensioni massime dei serramenti, dovrà considerare e valutare, oltre le dimensioni ed il momento d'inerzia dei profilati, anche le caratteristiche applicative e meteorologiche quali l'altezza dal suolo, l'esposizione alla pioggia e la velocità dei venti nella zona. Per questi dati consigliamo di consultare e seguire le "Raccomandazioni UNCSAAL" elaborate sulla base delle norme UNI, UNI-EN e UNI-CNR esistenti in merito.

Verificare che la freccia del profilato sia compatibile con quella del vetro utilizzato.

Le curve rappresentano la larghezza massima dell'anta in funzione della sua altezza e della pressione del vento.

Il serramento è considerato a 2 ante uguali.

Le curve sono calcolate sulla base della deformazione elastica di **1/300** dell'altezza del serramento.

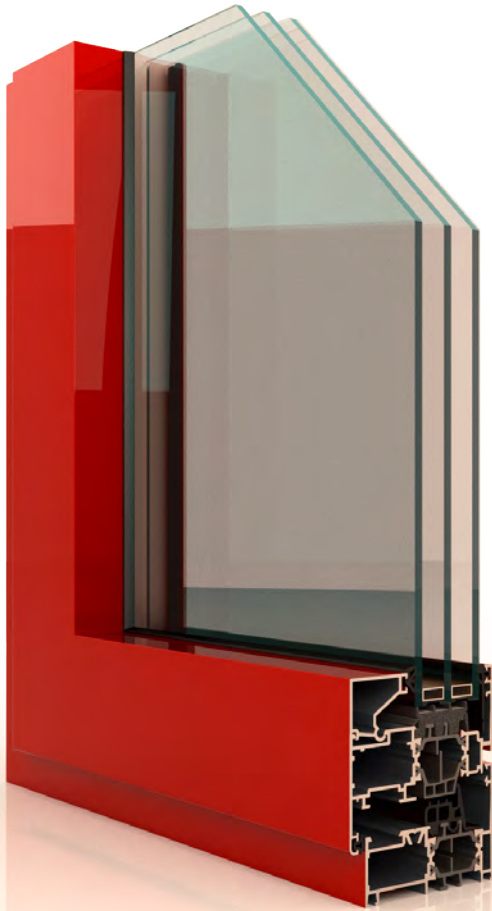

Profilati

Gruppo B

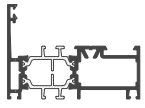

CX70.101HP			Tavola 10
Telaio ad L piccolo			
Peso	kg/ml. 1.232		
Jx 24.98 cm ⁴	Wx 6.61 cm ³		
Jy 5.28 cm ⁴	Wy 1.64 cm ³		

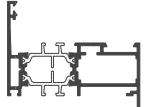
CX70.102HP			Tavola 10
Telaio a Z piccolo			
Peso	kg/ml. 1.311		
Jx 29.80 cm ⁴	Wx 8.44 cm ³		
Jy 8.40 cm ⁴	Wy 2.28 cm ³		

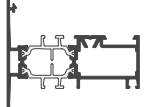
CX70.103HP			Tavola 10
Telaio a T piccolo			
Peso	kg/ml. 1.350		
Jx 28.59 cm ⁴	Wx 7.03 cm ³		
Jy 8.96 cm ⁴	Wy 2.43 cm ³		

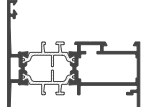
CX70.104HP			Tavola 10
Telaio ad h piccolo-soglia			
Peso	kg/ml. 1.429		
Jx 34.19 cm ⁴	Wx 9.08 cm ³		
Jy 11.46 cm ⁴	Wy 3.05 cm ³		

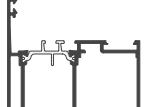
CX70.105HP			Tavola 11
Telaio ad L grande			
Peso	kg/ml. 1.637		
Jx 35.96 cm ⁴	Wx 9.31 cm ³		
Jy 20.35 cm ⁴	Wy 4.58 cm ³		

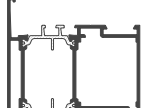
CX70.106HP			Tavola 11
Telaio a Z grande			
Peso	kg/ml. 1.750		
Jx 41.82 cm ⁴	Wx 11.43 cm ³		
Jy 26.76 cm ⁴	Wy 5.49 cm ³		

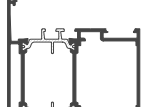
CX70.107HP			Tavola 11
Telaio a T grande			
Peso	kg/ml. 1.751		
Jx 38.46 cm ⁴	Wx 9.69 cm ³		
Jy 27.36 cm ⁴	Wy 5.62 cm ³		

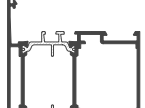
CX70.108HP			Tavola 11
Telaio ad h grande			
Peso	kg/ml. 1.867		
Jx 45.35 cm ⁴	Wx 11.88 cm ³		
Jy 32.93 cm ⁴	Wy 6.61 cm ³		

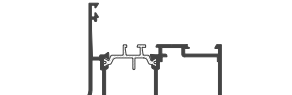
CX70.109HP			Tavola 35
Telaio per capannoni			
Peso	kg/ml. 2.969		
Jx 200.60 cm ⁴	Wx 23.57 cm ³		
Jy 85.16 cm ⁴	Wy 11.55 cm ³		

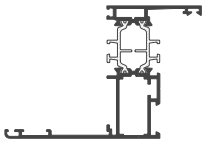
CX70.110HP			Tavola 12
Telaio a Z aletta battuta 54 mm.			
Peso	kg/ml. 1.476		
Jx 35.50 cm ⁴	Wx 9.04 cm ³		
Jy 23,22 cm ⁴	Wy 3,71 cm ³		

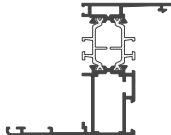
CX70.111HP			Tavola 12
Telaio a Z aletta battuta 40 mm.			
Peso	kg/ml. 1.415		
Jx 33.39 cm ⁴	Wx 8.83 cm ³		
Jy 15,00 cm ⁴	Wy 2,91 cm ³		

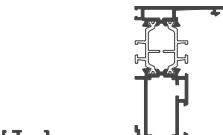
CX70.112HP			Tavola 12
Telaio a Z aletta battuta 70 mm.			
Peso	kg/ml. 1.571		
Jx 41.05 cm ⁴	Wx 9.58 cm ³		
Jy 37.52 cm ⁴	Wy 5,05 cm ³		

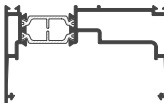
XX70.113			Tavola 12
Telaio di compensazione			
Peso	kg/ml. 1.456		
Jx 53.42 cm ⁴	Wx 12.40 cm ³		
Jy 10,98 cm ⁴	Wy 3,04 cm ³		

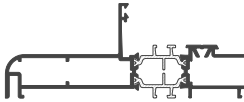
CX70.116HP			Tavola 14
Semi-Pilastrino			
Peso	kg/ml. 1.836		
Jx 00.00 cm ⁴	Wx 00.00 cm ³		
Jy 00.00 cm ⁴	Wy 00.00 cm ³		

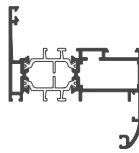
CX70.117HP			Tavola 14
Telaio Z piccolo rientro m.11.5			
Peso	kg/ml. 1.386		
Jx 29.98 cm ⁴	Wx 7.71 cm ³		
Jy 9.81 cm ⁴	Wy 2.54 cm ³		



<p>CX70.119HP</p> <p>Tel. a L complanare piccolo</p> <p>Peso kg/ml. 1.275</p> <p>Jx 30.03 cm⁴ Wx 5.40 cm³</p> <p>Jy 7.00 cm⁴ Wy 1.64 cm³</p>		Tavola 15	<p>CX70.152HP</p> <p>Telaio bombato ad L piccolo</p> <p>Peso kg/ml. 1.389</p> <p>Jx 34.86 cm⁴ Wx 10.56 cm³</p> <p>Jy 8.99 cm⁴ Wy 3.42 cm³</p>		Tavola 16
<p>CX70.120HP</p> <p>Tel. Z compl. picc. aletta 25 mm</p> <p>Peso kg/ml. 1.449</p> <p>Jx 38.96 cm⁴ Wx 11.61 cm³</p> <p>Jy 9.75 cm⁴ Wy 3.08 cm³</p>		Tavola 15	<p>CX70.153HP</p> <p>Telaio bombato a Z piccolo</p> <p>Peso kg/ml. 1.468</p> <p>Jx 42.01 cm⁴ Wx 11.98 cm³</p> <p>Jy 15.78 cm⁴ Wy 4.61 cm³</p>		Tavola 16
<p>CX70.121HP</p> <p>Tel. Z compl. picc. aletta 40 mm</p> <p>Peso kg/ml. 1.531</p> <p>Jx 42.78 cm⁴ Wx 10.15 cm³</p> <p>Jy 19.40 cm⁴ Wy 3.91 cm³</p>		Tavola 15	<p>CX70.155HP</p> <p>Tel. a L ornamentale piccolo</p> <p>Peso kg/ml. 1.309</p> <p>Jx 32.19 cm⁴ Wx 5.71 cm³</p> <p>Jy 6.99 cm⁴ Wy 1.70 cm³</p>		Tavola 13
<p>CX70.122HP</p> <p>Telaio / anta piccolo</p> <p>Peso kg/ml. 1.373</p> <p>Jx 29.86 cm⁴ Wx 8.41 cm³</p> <p>Jy 8.62 cm⁴ Wy 2.41 cm³</p>		Tavola 15	<p>CX70.156HP</p> <p>Tel. Z ornam. picc. aletta 25 mm</p> <p>Peso kg/ml. 1.486</p> <p>Jx 41.23 cm⁴ Wx 12.06 cm³</p> <p>Jy 10.05 cm⁴ Wy 3.21 cm³</p>		Tavola 13
<p>CX70.123HP</p> <p>Telaio / anta grande</p> <p>Peso kg/ml. 1.790</p> <p>Jx 41.45 cm⁴ Wx 11.56 cm³</p> <p>Jy 28.05 cm⁴ Wy 5.84 cm³</p>		Tavola 15	<p>CX70.157HP</p> <p>Telaio bombato a Z rientrato picc.</p> <p>Peso kg/ml. 1.503</p> <p>Jx 42.89 cm⁴ Wx 12.66 cm³</p> <p>Jy 18.73 cm⁴ Wy 5.44 cm³</p>		Tavola 16
<p>CX70.124HP</p> <p>Telaio a L piccolo ridotto</p> <p>Peso kg/ml. 1.214</p> <p>Jx 23.57 cm⁴ Wx 6.39 cm³</p> <p>Jy 5.00 cm⁴ Wy 1.53 cm³</p>		Tavola 14	<p>CX70.160HP</p> <p>Telaio bombato a Z rientrato picc.</p> <p>Peso kg/ml. 1.457</p> <p>Jx 38.41 cm⁴ Wx 9.07 cm³</p> <p>Jy 11.96 cm⁴ Wy 3.17 cm³</p>		Tavola 17
<p>CX70.125HP</p> <p>Tel Z picc.ridotto rientro mm.11.5</p> <p>Peso kg/ml. 1.357</p> <p>Jx 29.55 cm⁴ Wx 7.86 cm³</p> <p>Jy 10.08 cm⁴ Wy 2.83 cm³</p>		Tavola 14	<p>CX70.161HP</p> <p>Telaio bombato a Z rientrato picc.</p> <p>Peso kg/ml. 1.455</p> <p>Jx 41.91 cm⁴ Wx 8.19 cm³</p> <p>Jy 7.33 cm⁴ Wy 2.27 cm³</p>		Tavola 17
<p>CX70.127HP</p> <p>Tel. Z picc.ridotto rientro mm.8</p> <p>Peso kg/ml. 1.357</p> <p>Jx 31.43 cm⁴ Wx 8.59 cm³</p> <p>Jy 10.97 cm⁴ Wy 2.88 cm³</p>		Tavola 21	<p>CX70.162HP</p> <p>Telaio bombato a Z rientrato picc.</p> <p>Peso kg/ml. 1.632</p> <p>Jx 53.33 cm⁴ Wx 11.72 cm³</p> <p>Jy 14.27 cm⁴ Wy 3.73 cm³</p>		Tavola 17

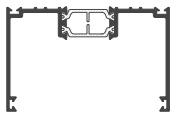
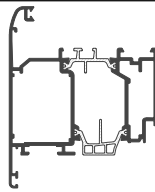
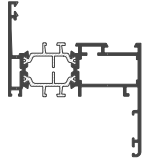
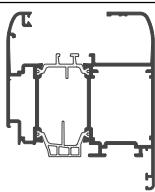
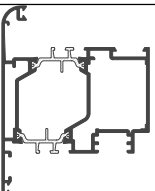
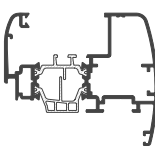
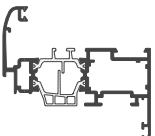
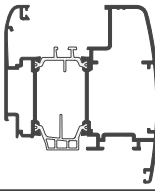
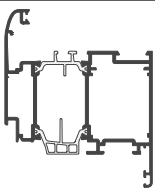
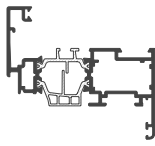
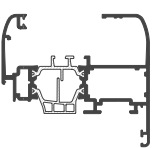
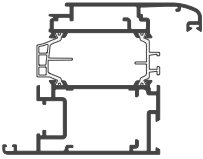
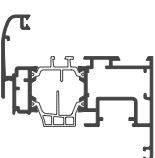
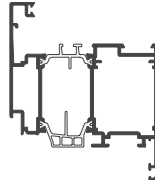

XX70.163 Telaio compensazione Peso kg/ml. 1.212 Jx 46.13 cm ⁴ Wx 10.72 cm ³ Jy 11.20 cm ⁴ Wy 3.08 cm ³		Tavola 16	CX70.205HP Anta apertura esterna Peso kg/ml. 2.004 Jx 52.27 cm ⁴ Wx 12.09 cm ³ Jy 33.26 cm ⁴ Wy 6.87 cm ³		Tavola 23 9
CX70.172HP Telaio a Z aletta battuta 32 mm. Peso kg/ml. 1.380 Jx 31.11 cm ⁴ Wx 8.26 cm ³ Jy 11.98 cm ⁴ Wy 2.67 cm ³		Tavola 13	CX70.206HP Anta tonda grande v/infilare Peso kg/ml. 2.053 Jx 56.75 cm ⁴ Wx 13.79 cm ³ Jy 39.71 cm ⁴ Wy 7.83 cm ³		Tavola 19
			CX70.207HP Anta apertura bilico Peso kg/ml. 2.075 Jx 54.02 cm ⁴ Wx 11.88 cm ³ Jy 37.93 cm ⁴ Wy 7.45 cm ³		Tavola 29
			CX70.209HP Anta piccola ellittica v/infilare Peso kg/ml. 1.686 Jx 00.00 cm ⁴ Wx 00.00 cm ³ Jy 00.00 cm ⁴ Wy 00.00 cm ³		Tavola 19
CX70.201HP Anta tonda piccola c/fermavetro Peso kg/ml. 1.491 Jx 37.73 cm ⁴ Wx 9.46 cm ³ Jy 9.96 cm ⁴ Wy 2.80 cm ³		Tavola 18	CX70.210HP Anta grande ellittica v/infilare Peso kg/ml. 2.170 Jx 00.00 cm ⁴ Wx 00.00 cm ³ Jy 00.00 cm ⁴ Wy 00.00 cm ³		Tavola 17 9
CX70.202HP Anta tonda grande c/fermavetro Peso kg/ml. 1.922 Jx 51.50 cm ⁴ Wx 13.13 cm ³ Jy 31.00 cm ⁴ Wy 6.51 cm ³		Tavola 18	CX70.215HP Anta diritta piccola c/fermavetro Peso kg/ml. 1.512 Jx 00.00 cm ⁴ Wx 00.00 cm ³ Jy 00.00 cm ⁴ Wy 00.00 cm ³		Tavola 21
CX70.203HP Anta tonda piccola v/infilare Peso kg/ml. 1.613 Jx 42.53 cm ⁴ Wx 9.93 cm ³ Jy 14.47 cm ⁴ Wy 3.76 cm ³		Tavola 19	CX70.225HP Anta tonda grande f/nastro Peso kg/ml. 2.405 Jx 53.11 cm ⁴ Wx 20.35 cm ³ Jy 26.22 cm ⁴ Wy 7.88 cm ³		Tavola 24
CX70.204HP Anta tonda piccola f/nastro Peso kg/ml. 1.749 Jx 47.57 cm ⁴ Wx 11.87 cm ³ Jy 14.63 cm ⁴ Wy 3.71 cm ³		Tavola 23	CX70.226HP Anta diritta grande c/fermavetro Peso kg/ml. 1.950 Jx 00.00 cm ⁴ Wx 00.00 cm ³ Jy 00.00 cm ⁴ Wy 00.00 cm ³		Tavola 21

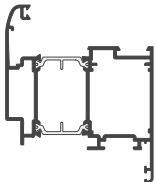
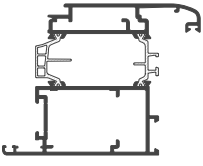
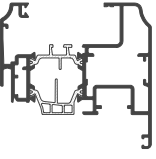
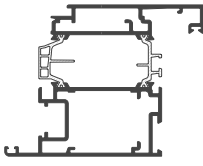
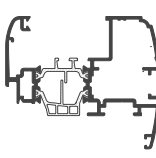
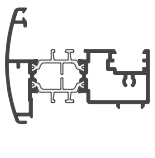
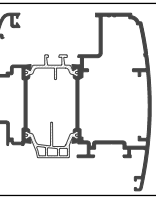
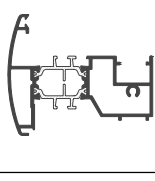
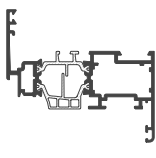
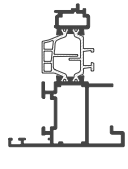
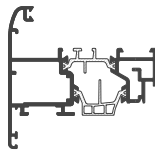
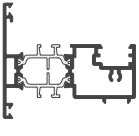
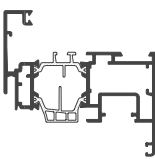
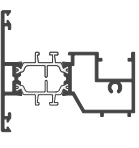
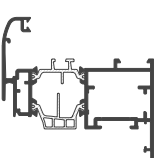
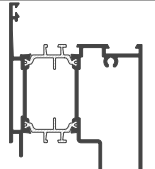

<p>CX70.227HP</p> <p>Anta doppia battuta grande</p> <p>Peso kg/ml. 1.870</p> <p>Jx 51.47 cm4 Wx 15.03 cm3</p> <p>Jy 32.33 cm4 Wy 6.41 cm3</p>		Tavola 22	<p>CX70.261HP</p> <p>Anta grande sormonto int. 10 mm</p> <p>Peso kg/ml. 2.094</p> <p>Jx 67.58 cm4 Wx 16.25 cm3</p> <p>Jy 49.62 cm4 Wy 9.45 cm3</p>		Tavola 25
<p>XX70.230HP</p> <p>Anta ornamentale ferr.nastro</p> <p>Peso kg/ml. 1.958</p> <p>Jx 38.99 cm4 Wx 10.63 cm3</p> <p>Jy 22.31 cm4 Wy 5.17 cm3</p>		Tavola 23	<p>CX70.262HP</p> <p>Anta dritta grande f/nastro</p> <p>Peso kg/ml. 2.427</p> <p>Jx 53.66 cm4 Wx 20.41 cm3</p> <p>Jy 26.75 cm4 Wy 7.96 cm3</p>		Tavola 24
<p>CX70.232HP</p> <p>Anta picc. ornamentale v/infilare</p> <p>Peso kg/ml. 1.718</p> <p>Jx 00.00 cm4 Wx 00.00 cm3</p> <p>Jy 00.00 cm4 Wy 00.00 cm3</p>		Tavola 20	<p>CX70.301HP</p> <p>Riporto tondo</p> <p>Peso kg/ml. 1.442</p> <p>Jx 33.71 cm4 Wx 8.34 cm3</p> <p>Jy 8.21 cm4 Wy 2.33 cm3</p>		Tavola 18
<p>CX70.233HP</p> <p>Anta grande ornamen. v/infilare</p> <p>Peso kg/ml. 2.194</p> <p>Jx 00.00 cm4 Wx 00.00 cm3</p> <p>Jy 00.00 cm4 Wy 00.00 cm3</p>		Tavola 20	<p>XX70.302HP</p> <p>Riporto tondo f/nastro</p> <p>Peso kg/ml. 1.418</p> <p>Jx 34.52 cm4 Wx 8.33 cm3</p> <p>Jy 9.49 cm4 Wy 2.59 cm3</p>		Tavola 23
<p>CX70.235HP</p> <p>Anta dritta rientro 5 mm.</p> <p>Peso kg/ml. 1.454</p> <p>Jx 00.00 cm4 Wx 00.00 cm3</p> <p>Jy 00.00 cm4 Wy 00.00 cm3</p>		Tavola 22	<p>CX70.303HP</p> <p>Riporto/inversione bilico</p> <p>Peso kg/ml. 1.311</p> <p>Jx 26.05 cm4 Wx 5.51 mm3</p> <p>Jy 6.92 cm4 Wy 2.10 mm3</p>		Tavola 31
<p>CX70.237HP</p> <p>Anta piccola apertura esterna</p> <p>Peso kg/ml. 1.659</p> <p>Jx 40.38 cm4 Wx 8.97 cm3</p> <p>Jy 13.21 cm4 Wy 3.51 cm3</p>		Tavola 24	<p>CX70.304HP</p> <p>Riporto dritto</p> <p>Peso kg/ml. 1.361</p> <p>Jx 00.00 cm4 Wx 00.00 cm3</p> <p>Jy 00.00 cm4 Wy 00.00 cm3</p>		Tavola 18
<p>CX70.238HP</p> <p>Anta dritta piccola f/nastro</p> <p>Peso kg/ml. 1.770</p> <p>Jx 48.70 cm4 Wx 12.03 cm3</p> <p>Jy 15.54 cm4 Wy 3.89 cm3</p>		Tavola 24	<p>XX70.308HP</p> <p>Riporto dritto f/nastro</p> <p>Peso kg/ml. 1.365</p> <p>Jx 30.62 cm4 Wx 7.81 cm3</p> <p>Jy 8.50 cm4 Wy 2.35 cm3</p>		Tavola 23
<p>CX70.260HP</p> <p>Anta piccola sormonto int. 10 mm</p> <p>Peso kg/ml. 1.728</p> <p>Jx 48.68 cm4 Wx 12.13 cm3</p> <p>Jy 14.97 cm4 Wy 3.90 cm3</p>		Tavola 25	<p>CX70.401HP</p> <p>Soprazoccolo</p> <p>Peso kg/ml. 1.912</p> <p>Jx 41.99 cm4 Wx 11.96 mm3</p> <p>Jy 39.08 cm4 Wy 7.72 mm3</p>		Tavola 27















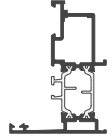

<p>CX70.402</p> <p>Traverso mm.96</p> <p>Peso kg/ml. 2.105</p> <p>Jx 43.81 cm⁴ Wx 11.08 mm³</p> <p>Jy 31.45 cm⁴ Wy 6.55 mm³</p>		<p>Tavola</p> <p>27</p>	<p>XX70.414</p> <p>Soglia bassa per porte</p> <p>Peso kg/ml. 0.922</p> <p>Jx 00.00 cm⁴ Wx 00.00 cm³</p> <p>Jy 00.00 cm⁴ Wy 00.00 cm³</p>		<p>Tavola</p> <p>28</p>
<p>CX70.403</p> <p>Fascia mm. 158</p> <p>Peso kg/ml. 3.130</p> <p>Jx 73.53 cm⁴ Wx 18.10 cm³</p> <p>Jy 190.58 cm⁴ Wy 24.12 cm³</p>		<p>Tavola</p> <p>28</p>	<p>CX70.415HP</p> <p>Fascia compl. da 78 x 158 mm.</p> <p>Peso kg/ml. 3.259</p> <p>Jx 00.00 cm⁴ Wx 0.00 cm³</p> <p>Jy 00.00 cm⁴ Wy 0.00 cm³</p>		<p>Tavola</p> <p>22</p>
<p>CX70.404</p> <p>Zoccolo mm. 158</p> <p>Peso kg/ml. 3.240</p> <p>Jx 79.47 cm⁴ Wx 20.25 cm³</p> <p>Jy 212.70 cm⁴ Wy 25.47 cm³</p>		<p>Tavola</p> <p>28</p>			
<p>XX70.405HP</p> <p>Traverso v/infilare mm. 96</p> <p>Peso kg/ml. 1.685</p> <p>Jx 20.40 cm⁴ Wx 5.66 cm³</p> <p>Jy 31.96 cm⁴ Wy 9.41 cm³</p>		<p>Tavola</p> <p>26</p>	<p>CX70.521</p> <p>Fermavetro tondo mm. 14</p> <p>Peso kg/ml. 0.266</p> <p>Jx 00.00 cm⁴ Wx 00.00 cm³</p> <p>Jy 00.00 cm⁴ Wy 00.00 cm³</p>		<p>Tavola</p> <p>38</p>
<p>XX70.406HP</p> <p>Traverso v/infilare mm. 158</p> <p>Peso kg/ml. 3.334</p> <p>Jx 70.30 cm⁴ Wx 20.98 cm³</p> <p>Jy 231.32 cm⁴ Wy 29.28 cm³</p>		<p>Tavola</p> <p>26</p>	<p>CX70.522</p> <p>Fermavetro tondo mm. 18</p> <p>Peso kg/ml. 0.277</p> <p>Jx 00.00 cm⁴ Wx 00.00 cm³</p> <p>Jy 00.00 cm⁴ Wy 00.00 cm³</p>		<p>Tavola</p> <p>38</p>
<p>XX70.407HP</p> <p>Soprazoccolo v/infilare mm. 74</p> <p>Peso kg/ml. 1.840</p> <p>Jx 33.98 cm⁴ Wx 10.92 cm³</p> <p>Jy 30.61 cm⁴ Wy 7.44 cm³</p>		<p>Tavola</p> <p>26</p>	<p>CX70.523</p> <p>Fermavetro tondo mm. 22</p> <p>Peso kg/ml. 0.294</p> <p>Jx 00.00 cm⁴ Wx 00.00 cm³</p> <p>Jy 00.00 cm⁴ Wy 00.00 cm³</p>		<p>Tavola</p> <p>38</p>
<p>CX70.408HP</p> <p>Traverso piccolo mm. 72</p> <p>Peso kg/ml. 1.429</p> <p>Jx 28.98 cm⁴ Wx 7.23 cm³</p> <p>Jy 9.52 cm⁴ Wy 2.64 cm³</p>		<p>Tavola</p> <p>31</p>	<p>CX70.524</p> <p>Fermavetro tondo mm. 26</p> <p>Peso kg/ml. 0.314</p> <p>Jx 00.00 cm⁴ Wx 00.00 cm³</p> <p>Jy 00.00 cm⁴ Wy 00.00 cm³</p>		<p>Tavola</p> <p>38</p>
<p>CX70.409</p> <p>Soglia bassa</p> <p>Peso kg/ml. 0.786</p> <p>Jx 14.28 cm⁴ Wx 3,91 cm³</p> <p>Jy 0,60 cm⁴ Wy 0,41 cm³</p>		<p>Tavola</p> <p>13</p>	<p>CX70.525</p> <p>Fermavetro tondo mm. 30</p> <p>Peso kg/ml. 0.350</p> <p>Jx 00.00 cm⁴ Wx 00.00 cm³</p> <p>Jy 00.00 cm⁴ Wy 00.00 cm³</p>		<p>Tavola</p> <p>38</p>



<p>CX70.526</p> <p>Fermavetro diritto mm. 14</p> <p>Peso kg/ml. 0.279</p> <p>Jx 00.00 cm⁴ Wx 00.00 cm³</p> <p>Jy 00.00 cm⁴ Wy 00.00 cm³</p>		Tavola 39	<p>CX70.537</p> <p>Fermavetro diritto mm. 40</p> <p>Peso kg/ml. 0.403</p> <p>Jx 00.00 cm⁴ Wx 0.00 cm³</p> <p>Jy 00.00 cm⁴ Wy 0.00 cm³</p>		Tavola 39
<p>CX70.527</p> <p>Fermavetro diritto mm. 18</p> <p>Peso kg/ml. 0.290</p> <p>Jx 00.00 cm⁴ Wx 00.00 cm³</p> <p>Jy 00.00 cm⁴ Wy 00.00 cm³</p>		Tavola 39	<p>CX70.539</p> <p>Fermavetro diritto mm. 10</p> <p>Peso kg/ml. 0.245</p> <p>Jx 00.00 cm⁴ Wx 0.00 cm³</p> <p>Jy 00.00 cm⁴ Wy 0.00 cm³</p>		Tavola 39
<p>CX70.528</p> <p>Fermavetro diritto mm. 22</p> <p>Peso kg/ml. 0.307</p> <p>Jx 00.00 cm⁴ Wx 0.00 cm³</p> <p>Jy 00.00 cm⁴ Wy 0.00 cm³</p>		Tavola 39	<p>CX70.562</p> <p>Fermavetro sicurezza mm. 14</p> <p>Peso kg/ml. 0.324</p> <p>Jx 00.00 cm⁴ Wx 00.00 cm³</p> <p>Jy 00.00 cm⁴ Wy 00.00 cm³</p>		Tavola 41
<p>CX70.529</p> <p>Fermavetro diritto mm. 26</p> <p>Peso kg/ml. 0.327</p> <p>Jx 00.00 cm⁴ Wx 0.00 cm³</p> <p>Jy 00.00 cm⁴ Wy 0.00 cm³</p>		Tavola 39	<p>CX70.563</p> <p>Fermavetro sicurezza mm. 18</p> <p>Peso kg/ml. 0.330</p> <p>Jx 00.00 cm⁴ Wx 00.00 cm³</p> <p>Jy 00.00 cm⁴ Wy 00.00 cm³</p>		Tavola 41
<p>CX70.530</p> <p>Fermavetro diritto mm. 30</p> <p>Peso kg/ml. 0.362</p> <p>Jx 00.00 cm⁴ Wx 0.00 cm³</p> <p>Jy 00.00 cm⁴ Wy 0.00 cm³</p>		Tavola 39	<p>CX70.564</p> <p>Fermavetro sicurezza mm. 22</p> <p>Peso kg/ml. 0.348</p> <p>Jx 00.00 cm⁴ Wx 0.00 cm³</p> <p>Jy 00.00 cm⁴ Wy 0.00 cm³</p>		Tavola 41
<p>CX70.531</p> <p>Fermavetro tondo mm. 35</p> <p>Peso kg/ml. 0.370</p> <p>Jx 00.00 cm⁴ Wx 0.00 cm³</p> <p>Jy 00.00 cm⁴ Wy 0.00 cm³</p>		Tavola 38	<p>CX70.565</p> <p>Fermavetro sicurezza mm. 26</p> <p>Peso kg/ml. 0.372</p> <p>Jx 00.00 cm⁴ Wx 0.00 cm³</p> <p>Jy 00.00 cm⁴ Wy 0.00 cm³</p>		Tavola 41
<p>CX70.532</p> <p>Fermavetro diritto mm. 35</p> <p>Peso kg/ml. 0.383</p> <p>Jx 00.00 cm⁴ Wx 0.00 cm³</p> <p>Jy 00.00 cm⁴ Wy 0.00 cm³</p>		Tavola 39	<p>CX70.566</p> <p>Fermavetro sicurezza mm. 30</p> <p>Peso kg/ml. 0.396</p> <p>Jx 00.00 cm⁴ Wx 0.00 cm³</p> <p>Jy 00.00 cm⁴ Wy 0.00 cm³</p>		Tavola 41
<p>CX70.533</p> <p>Fermavetro diritto mm. 5</p> <p>Peso kg/ml. 0.252</p> <p>Jx 00.00 cm⁴ Wx 0.00 cm³</p> <p>Jy 00.00 cm⁴ Wy 0.00 cm³</p>		Tavola 39	<p>CX70.567</p> <p>Fermavetro sicurezza mm. 35</p> <p>Peso kg/ml. 0.434</p> <p>Jx 00.00 cm⁴ Wx 0.00 cm³</p> <p>Jy 00.00 cm⁴ Wy 0.00 cm³</p>		Tavola 41





CX70.568 Fermavetro sicurezza mm. 10 Peso kg/ml. 0.297 Jx 00.00 cm ⁴ Wx 0.00 cm ³ Jy 00.00 cm ⁴ Wy 0.00 cm ³		Tavola 41	XX70.601 Gocciolatoio Peso kg/ml. 0.269 Jx 00.00 cm ⁴ Wx 0.00 cm ³ Jy 00.00 cm ⁴ Wy 0.00 cm ³		Tavola 21
CX70.571 Fermavetro clips tondo mm. 14 Peso kg/ml. 0.216 Jx 00.00 cm ⁴ Wx 00.00 cm ³ Jy 00.00 cm ⁴ Wy 00.00 cm ³		Tavola 40	XX70.602 Porta spazzolino Peso kg/ml. 0.372 Jx 00.00 cm ⁴ Wx 0.00 cm ³ Jy 00.00 cm ⁴ Wy 0.00 cm ³		Tavola 21
CX70.572 Fermavetro clips tondo mm. 18 Peso kg/ml. 0.262 Jx 00.00 cm ⁴ Wx 00.00 cm ³ Jy 00.00 cm ⁴ Wy 00.00 cm ³		Tavola 40	XX70.603 Soglia piatta da mm. 5 Peso kg/ml. 0.275 Jx 00.00 cm ⁴ Wx 0.00 cm ³ Jy 00.00 cm ⁴ Wy 0.00 cm ³		Tavola 21
CX70.573 Fermavetro clips tondo mm. 22 Peso kg/ml. 0.283 Jx 00.00 cm ⁴ Wx 00.00 cm ³ Jy 00.00 cm ⁴ Wy 00.00 cm ³		Tavola 40	CX70.604HP Inversione di battuta Peso kg/ml. 1.116 Jx 16.97 cm ⁴ Wx 5.83 cm ³ Jy 4.77 cm ⁴ Wy 1.50 cm ³		Tavola 25
CX70.574 Fermavetro clips tondo mm. 26 Peso kg/ml. 0.313 Jx 00.00 cm ⁴ Wx 00.00 cm ³ Jy 00.00 cm ⁴ Wy 00.00 cm ³		Tavola 40	CX70.605 Astina Peso kg/ml. 0.146 Jx 0,00 cm ⁴ Wx 0,00 cm ³ Jy 0,00 cm ⁴ Wy 0,00 cm ³		Tavola 18
CX70.575 Fermavetro clips tondo mm. 30 Peso kg/ml. 0.340 Jx 00.00 cm ⁴ Wx 00.00 cm ³ Jy 00.00 cm ⁴ Wy 00.00 cm ³		Tavola 40	XX70.606 Scivolo esterno soglia bassa Peso kg/ml. 0.322 Jx 0,00 cm ⁴ Wx 0,00 cm ³ Jy 0,00 cm ⁴ Wy 0,00 cm ³		Tavola 13
CX70.581 Fermavetro clips tondo mm. 35 Peso kg/ml. 0.361 Jx 00.00 cm ⁴ Wx 00.00 cm ³ Jy 00.00 cm ⁴ Wy 00.00 cm ³		Tavola 40	XX70.607 Scivolo interno soglia bassa Peso kg/ml. 0.224 Jx 0,00 cm ⁴ Wx 0,00 cm ³ Jy 0,00 cm ⁴ Wy 0,00 cm ³		Tavola 13
			RX70.609 Prof. di chiusura rinforzo montanti Peso kg/ml. 0.393 Jx 0.10 cm ⁴ Wx 0.11 cm ³ Jy 3.99 cm ⁴ Wy 1.53 cm ³		Tavola 23

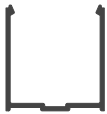

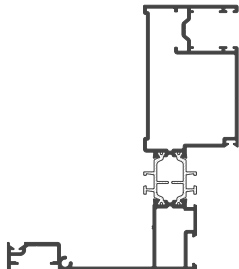
RX70.610			Tavola 23
Profilo per rinforzo montanti			
Peso	kg/ml. 0.994		
Jx	12.49 cm ⁴ Wx 3.56 cm ³		
Jy	17.78 cm ⁴ Wy 6.84 cm ³		

CX70.702HP			Tavola 26
Spalla laterale aperta			
Peso	kg/ml. 2.534		
Jx	222.35 cm ⁴ Wx 28.56 cm ³		
Jy	91.91 cm ⁴ Wy 11.55 cm ³		

XX70.611			Tavola 24
Profilo per squadretta			
Peso	kg/ml. 3.426		
Jx	00.00 cm ⁴ Wx 0.00 cm ³		
Jy	00.00 cm ⁴ Wy 0.00 cm ³		

XX70.612			Tavola 13
Profilo bancalino			
Peso	kg/ml. 0.245		
Jx	00.00 cm ⁴ Wx 0.00 cm ³		
Jy	00.00 cm ⁴ Wy 0.00 cm ³		

XX70.703			Tavola 27
Traverso superiore monoblocco			
Peso	kg/ml. 0.791		
Jx	00.00 cm ⁴ Wx 0.00 cm ³		
Jy	00.00 cm ⁴ Wy 0.00 cm ³		

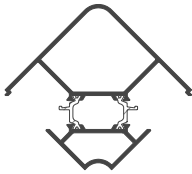
XX70.613			Tavola 24
Profilo angolo universale			
Peso	kg/ml. 1.885		
Jx	00.00 cm ⁴ Wx 0.00 cm ³		
Jy	00.00 cm ⁴ Wy 0.00 cm ³		

XX70.704			Tavola 27
Coprivite			
Peso	kg/ml. 0.135		
Jx	00.00 cm ⁴ Wx 0.00 cm ³		
Jy	00.00 cm ⁴ Wy 0.00 cm ³		

XX70.627			Tavola 22
Battuta riportata per zoccolo			
Peso	kg/ml. 0.649		
Jx	00.00 cm ⁴ Wx 0.00 cm ³		
Jy	00.00 cm ⁴ Wy 0.00 cm ³		

XX70.705			Tavola 27
Profilo battuta cassonetto			
Peso	kg/ml. 0.155		
Jx	00.00 cm ⁴ Wx 0.00 cm ³		
Jy	00.00 cm ⁴ Wy 0.00 cm ³		

XX60.635			Tavola 15 - b
Battuta riportata per telaio			
Peso	kg/ml. 0.306		
Jx	00.00 cm ⁴ Wx 0.00 cm ³		
Jy	00.00 cm ⁴ Wy 0.00 cm ³		

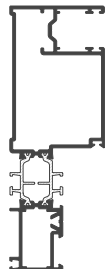
CX70.706HP			Tavola 27
Mezza spalla monoblocco			
Peso	kg/ml. 2.147		
Jx	165.80 cm ⁴ Wx 22.14 cm ³		
Jy	18.80 cm ⁴ Wy 6.56 cm ³		

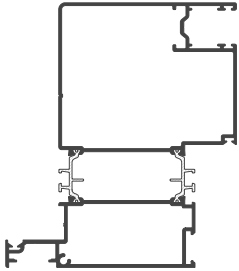
CX70.701			Tavola 26
Spalla laterale chiusa			
Peso	kg/ml. 3.083		
Jx	260.63 cm ⁴ Wx 34.86 cm ³		
Jy	136.59 cm ⁴ Wy 20.42 cm ³		

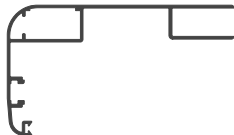
XX70.801			Tavola 30
Imbotte da mm.120			
Peso	kg/ml. 1.317		
Jx	76.93 cm ⁴ Wx 9.91 cm ³		
Jy	20.54 cm ⁴ Wy 4.10 cm ³		





Serie **SLIM**

XX70.802			Tavola 30
Prolunga da 90 mm. per imbotte			
Peso	kg/ml. 0.882		
Jx	00.00 cm ⁴ Wx 0.00 cm ³		
Jy	00.00 cm ⁴ Wy 0.00 cm ³		

XX70.803			Tavola 30
Prolunga da 50 mm. per imbotte			
Peso	kg/ml. 0.574		
Jx	00.00 cm ⁴ Wx 0.00 cm ³		
Jy	00.00 cm ⁴ Wy 0.00 cm ³		

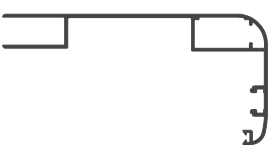
XX70.808			Tavola 30
Profilo jolly per imbotte			
Peso	kg/ml. 0.750		
Jx	00.00 cm ⁴ Wx 0.00 cm ³		
Jy	00.00 cm ⁴ Wy 0.00 cm ³		

XX70.809			Tavola 30
Imbotte da mm.140			
Peso	kg/ml. 1.580		
Jx	123.04 cm ⁴ Wx 13.89 cm ³		
Jy	22.31 cm ⁴ Wy 4.30 cm ³		

CX45.3362			Tavola 28
Profilo centrale cassonetto			
Peso	kg/ml. 1.150		
Jx	00.00 cm ⁴ Wx 0.00 cm ³		
Jy	00.00 cm ⁴ Wy 0.00 cm ³		

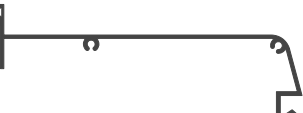
CX45.3363			Tavola 28
Profilo sup./ inf. cassonetto			
Peso	kg/ml. 1.379		
Jx	00.00 cm ⁴ Wx 0.00 cm ³		
Jy	00.00 cm ⁴ Wy 0.00 cm ³		

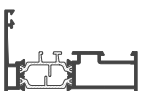
CX70S.101HP			Tavola 42
Telaio SLIM ad " L "			
Peso	kg/ml. 1.023		
Jx	21.13 cm ⁴ Wx 5.42 cm ³		
Jy	3.59 cm ⁴ Wy 1.20 cm ³		

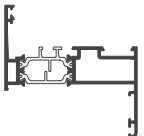
CX70S.102HP			Tavola 42
Telaio SLIM ad " Z "			
Peso	kg/ml. 1.155		
Jx	27.10 cm ⁴ Wx 7.54 cm ³		
Jy	7.19 cm ⁴ Wy 1.96 cm ³		

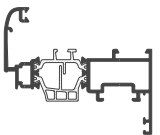
CX70S.201HP			Tavola 43
Anta piccola SLIM			
Peso	kg/ml. 1.337		
Jx	35.10 cm ⁴ Wx 8.76 cm ³		
Jy	8.37 cm ⁴ Wy 2.48 cm ³		

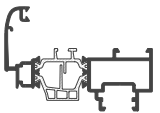
CX70S.201RHP			Tavola 43
Anta piccola SLIM s/battuta			
Peso	kg/ml. 1.291		
Jx	30.48 cm ⁴ Wx 7.53 cm ³		
Jy	6.70 cm ⁴ Wy 2.09 cm ³		

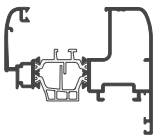
CX70S.203HP			Tavola 43
Anta piccola v.inf.SLIM			
Peso	kg/ml. 1.488		
Jx	38.79 cm ⁴ Wx 9.03 cm ³		
Jy	13.52 cm ⁴ Wy 3.56 cm ³		

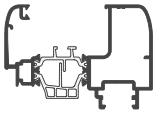
CX70S.203RHP			Tavola 43
Anta piccola v.inf.SLIM s/battuta			
Peso	kg/ml. 1.443		
Jx	34.80 cm ⁴ Wx 8.52 cm ³		
Jy	11.38 cm ⁴ Wy 4.09 cm ³		

CX60S.304			Tavola 42
Incontro centrale			
Peso	kg/ml. 0.427		
Jx	1.18 cm ⁴ Wx 0.59 cm ³		
Jy	1.67 cm ⁴ Wy 0.70 cm ³		

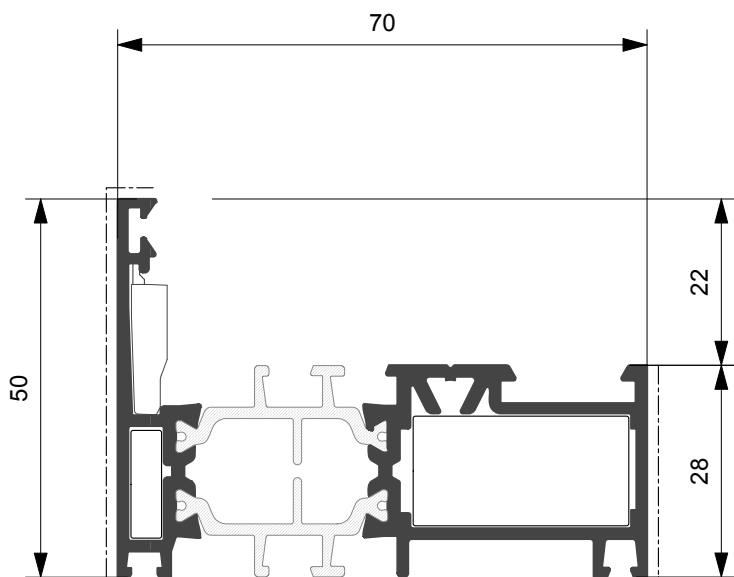

CX70.101HP

Kg/ml 1.232
--- mm. 78,0

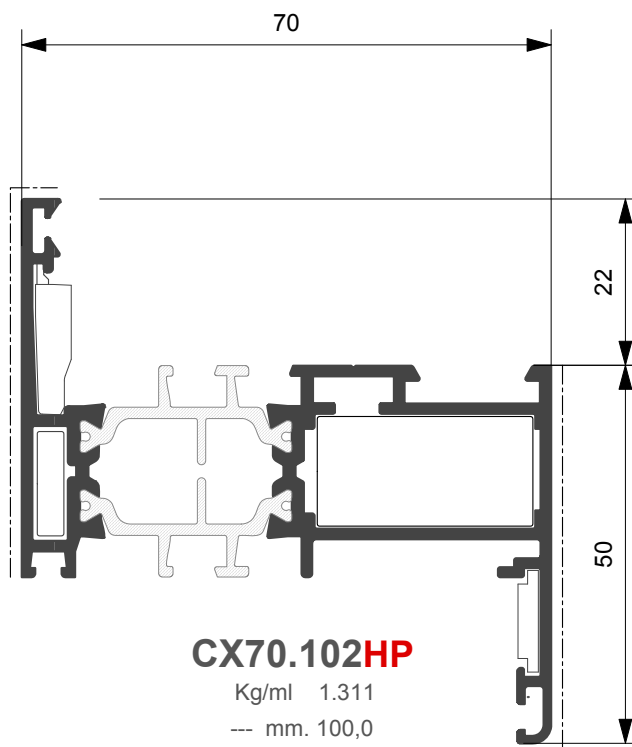

CX70.102HP

Kg/ml 1.311
--- mm. 100,0

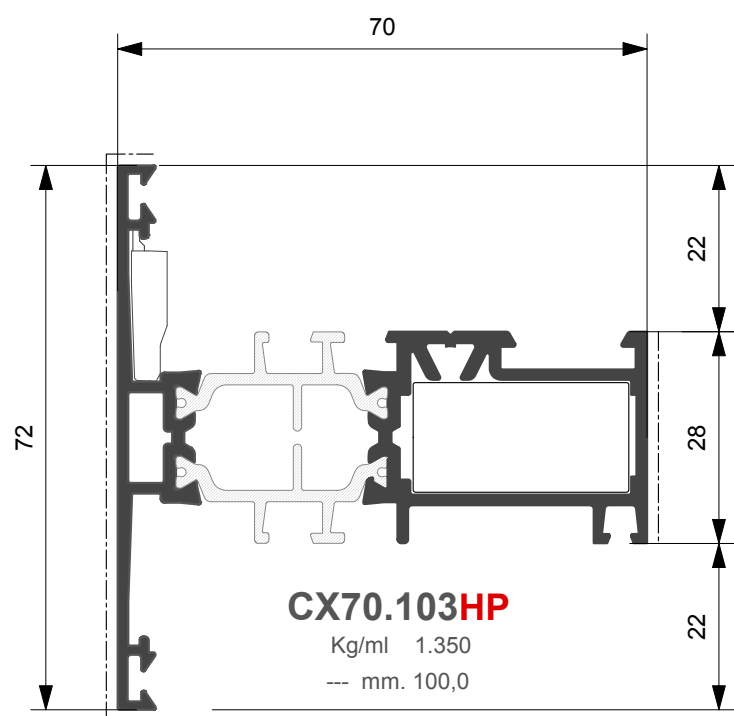

CX70.103HP

Kg/ml 1.350
--- mm. 100,0

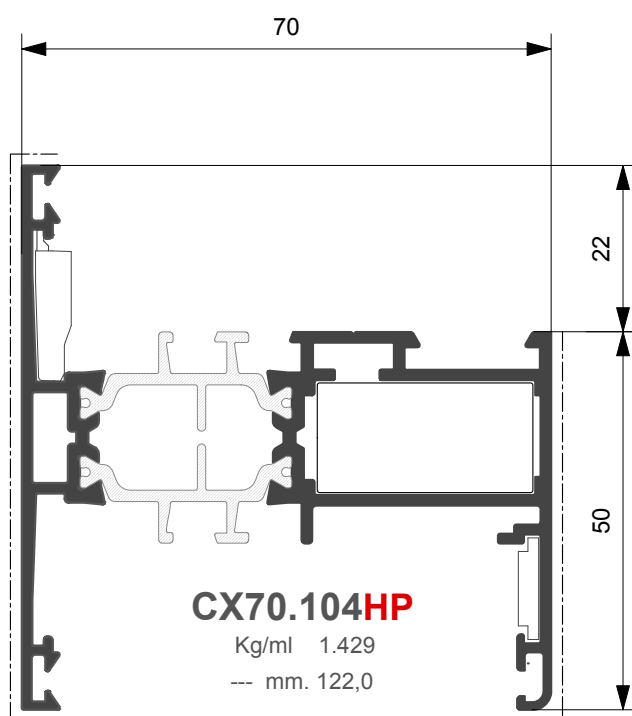

CX70.104HP

Kg/ml 1.429
--- mm. 122,0

Profilato	Squadretta esterna		Squadretta interna			Squadretta allineamento	
	Cianfrinare	Spinare	Bottone	Cianfrinare	Spinare	Esterna	Interna
CX70.101HP	ARX.03.SQ	ARX.03.SQ + ARX.08.SQ	ACX.01.SQ	ACX.02.SQ	ACX.02.SQ + ARX.07.SQ	ARX.15.SQ	
CX70.102HP	ARX.03.SQ	ARX.03.SQ + ARX.08.SQ	ACX.01.SQ	ACX.02.SQ	ACX.02.SQ + ARX.07.SQ	ARX.15.SQ	ARX.10.SQ
CX70.103HP			ACX.01.SQ	ACX.02.SQ	ACX.02.SQ + ARX.07.SQ	ARX.15.SQ	
CX70.104HP			ACX.01.SQ	ACX.02.SQ	ACX.02.SQ + ARX.07.SQ	ARX.15.SQ	ARX.10.SQ

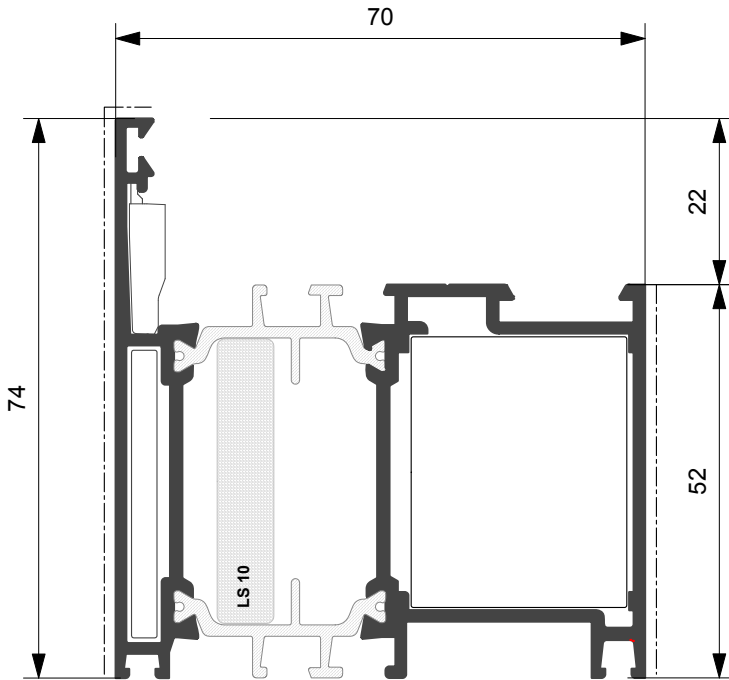

CX70.105HP

Kg/ml 1.637
--- mm. 126,0

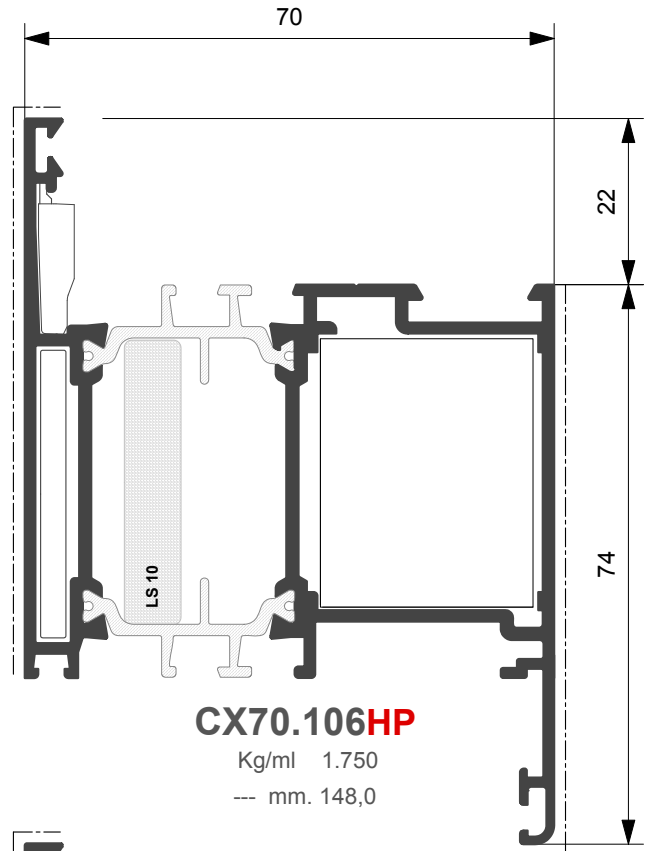

CX70.106HP

Kg/ml 1.750
--- mm. 148,0

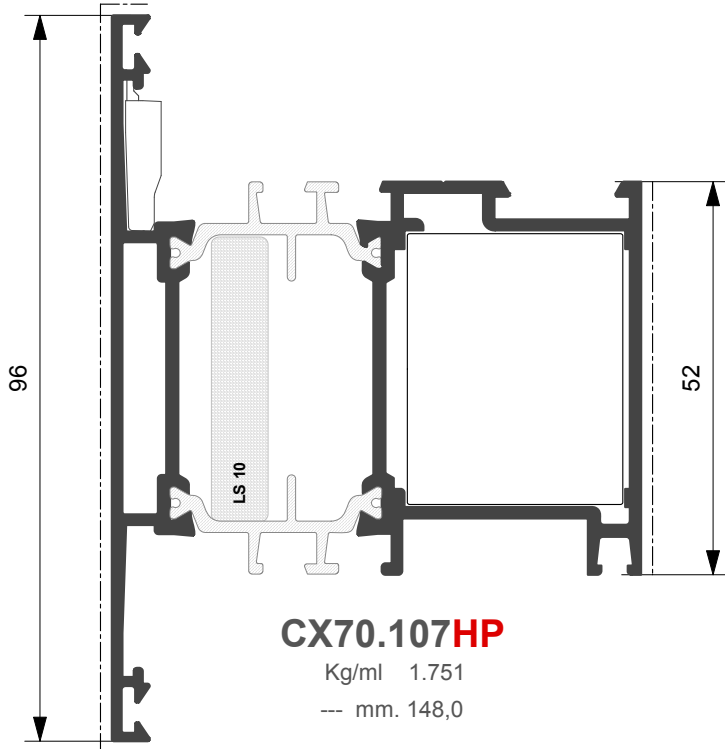

CX70.107HP

Kg/ml 1.751
--- mm. 148,0

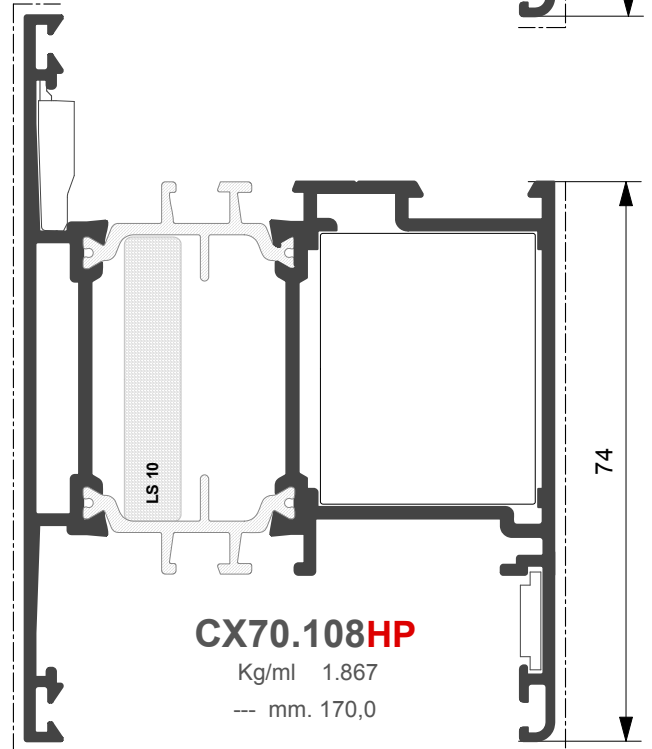

CX70.108HP

Kg/ml 1.867
--- mm. 170,0

Profilato	Squadretta esterna		Squadretta interna			Squadretta allineamento	
	Cianfrinare	Spinare	Bottone	Cianfrinare	Spinare o Avvitare	Esterna	Interna
CX70.105HP	ARX.06.SQ	ARX.06.SQ + ARX.08.SQ	ACX.04.SQ	ACX.14.SQ	ACX.14.SQ	ARX.15.SQ	
CX70.106HP	ARX.06.SQ	ARX.06.SQ + ARX.08.SQ	ACX.04.SQ	ACX.14.SQ	ACX.14.SQ	ARX.15.SQ	ARX.10.SQ
CX70.107HP			ACX.04.SQ	ACX.14.SQ	ACX.14.SQ	ARX.15.SQ	
CX70.108HP			ACX.04.SQ	ACX.14.SQ	ACX.14.SQ	ARX.15.SQ	ARX.10.SQ

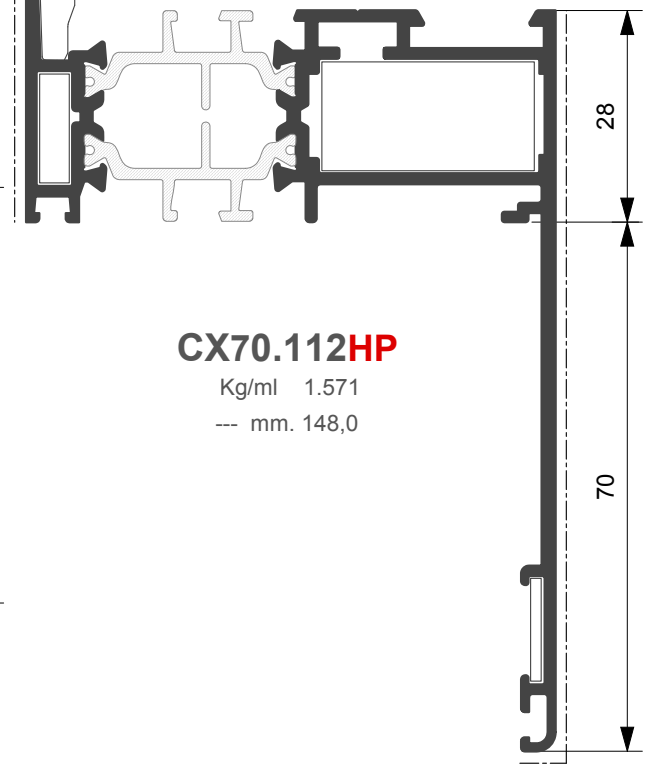
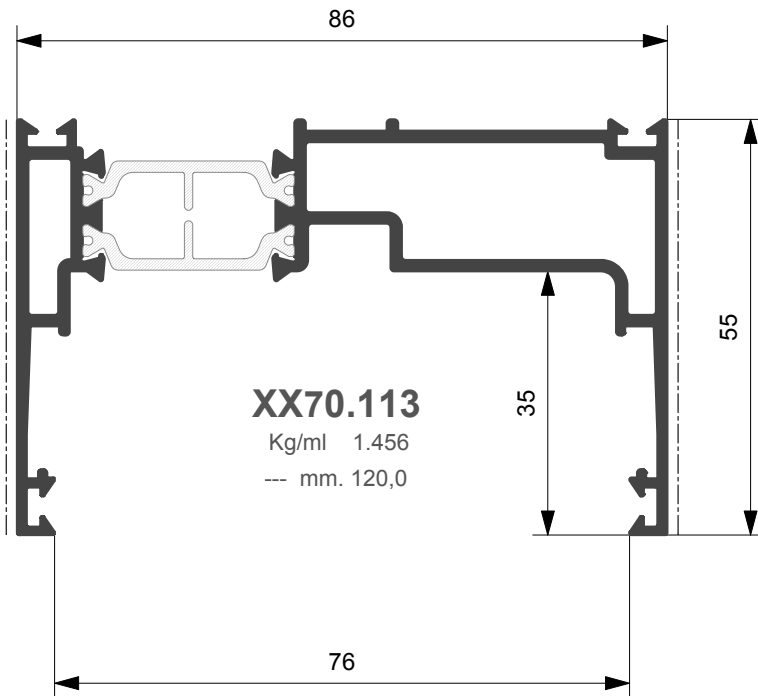
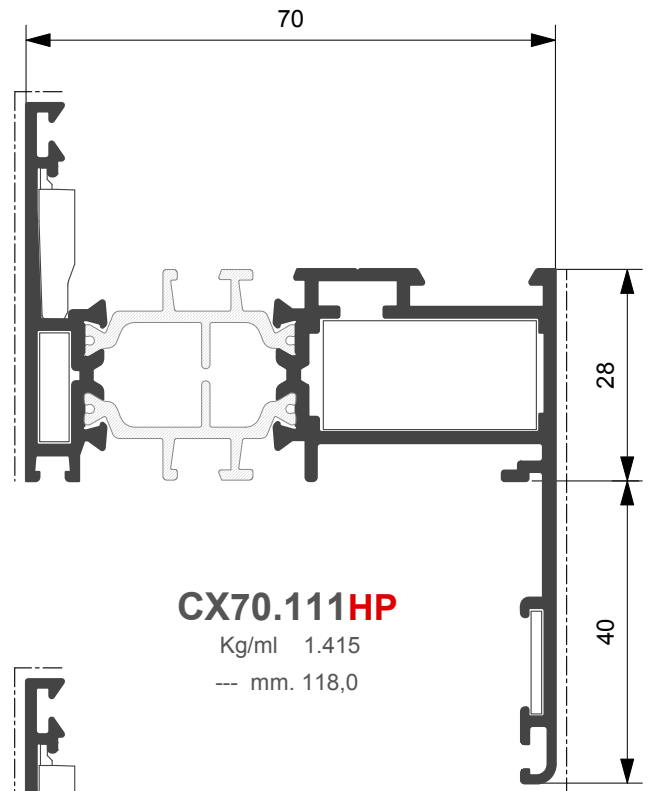
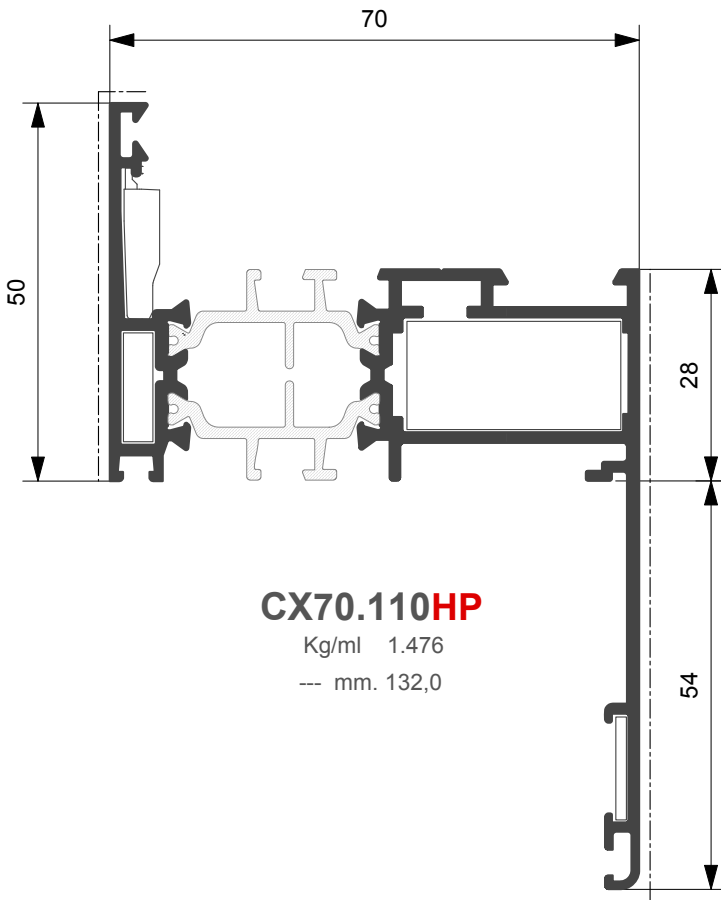

Profilato	Squadretta esterna		Squadretta interna			Squadretta allineamento	
	Cianfrinare	Spinare	Bottone	Cianfrinare	Spinare	Esterna	Interna
CX70.110HP	ARX.03.SQ	ARX.03.SQ + ARX.08.SQ	ACX.01.SQ	ACX.02.SQ	ACX.02.SQ + ARX.07.SQ	ARX.15.SQ	ARX.10.SQ
CX70.111HP	ARX.03.SQ	ARX.03.SQ + ARX.08.SQ	ACX.01.SQ	ACX.02.SQ	ACX.02.SQ + ARX.07.SQ	ARX.15.SQ	ARX.10.SQ
CX70.112HP	ARX.03.SQ	ARX.03.SQ + ARX.08.SQ	ACX.01.SQ	ACX.02.SQ	ACX.02.SQ + ARX.07.SQ	ARX.15.SQ	ARX.10.SQ

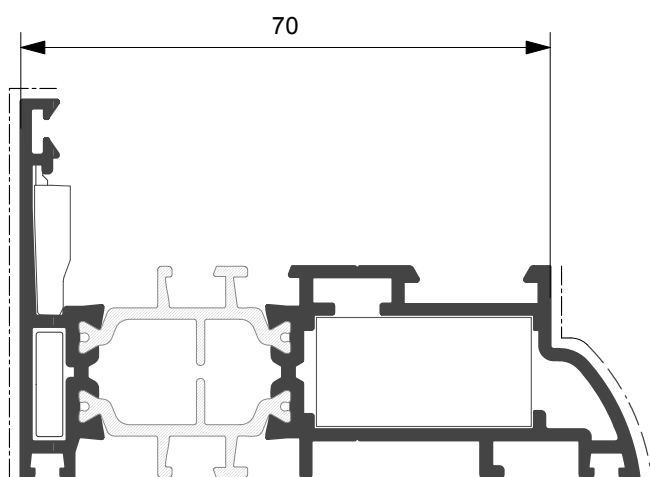

CX70.155HP

Kg/ml 1.309
--- mm. 88,0

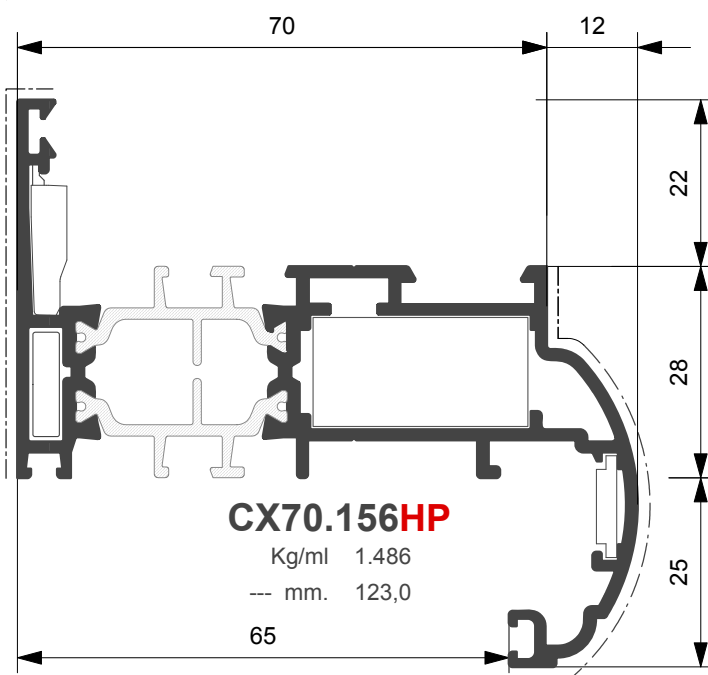

CX70.156HP

Kg/ml 1.486
--- mm. 123,0

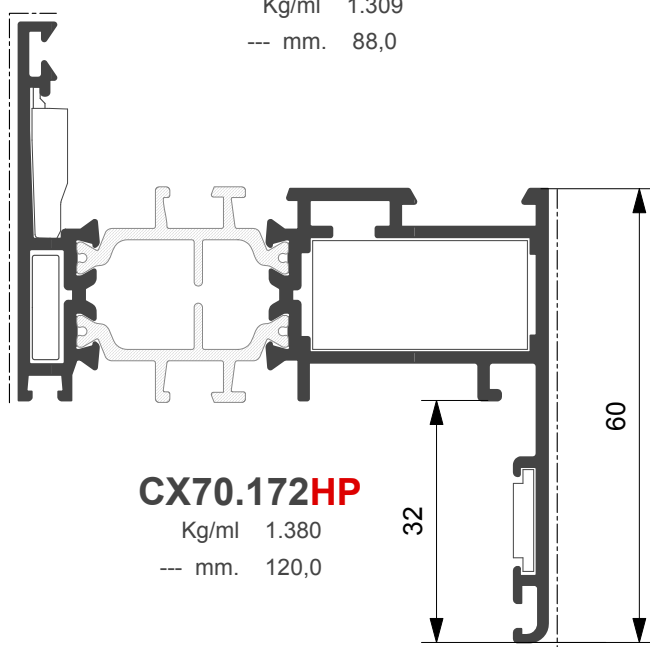

CX70.172HP

Kg/ml 1.380
--- mm. 120,0

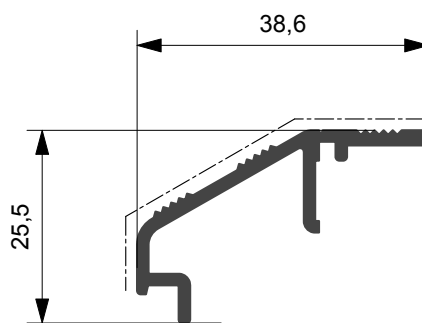

XX70.606

Kg/ml 0.322
--- mm. 50,0

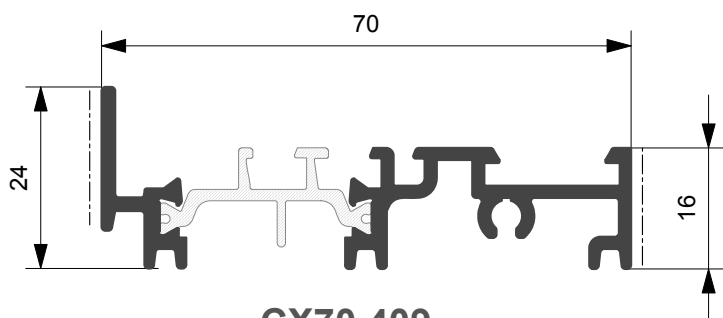

CX70.409

Kg/ml 0.785
--- mm. 34,0

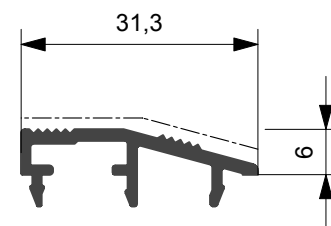

XX70.607

Kg/ml 0.224
--- mm. 32,0

Profilato	Squadretta esterna		Squadretta interna			Squadretta allineamento	
	Cianfrinare	Spinare	Bottone	Cianfrinare	Spinare	Esterna	Interna
CX70.155HP	ARX.03.SQ	ARX.03.SQ + ARX.08.SQ	ACX.01.SQ	ACX.02.SQ	ACX.02.SQ + ARX.07.SQ	ARX.15.SQ	
CX70.156HP	ARX.03.SQ	ARX.03.SQ + ARX.08.SQ	ACX.01.SQ	ACX.02.SQ	ACX.02.SQ + ARX.07.SQ	ARX.15.SQ	ARX.10.SQ
CX70.172HP	ARX.03.SQ	ARX.03.SQ + ARX.08.SQ	ACX.01.SQ	ACX.02.SQ	ACX.02.SQ + ARX.07.SQ	ARX.15.SQ	ARX.10.SQ

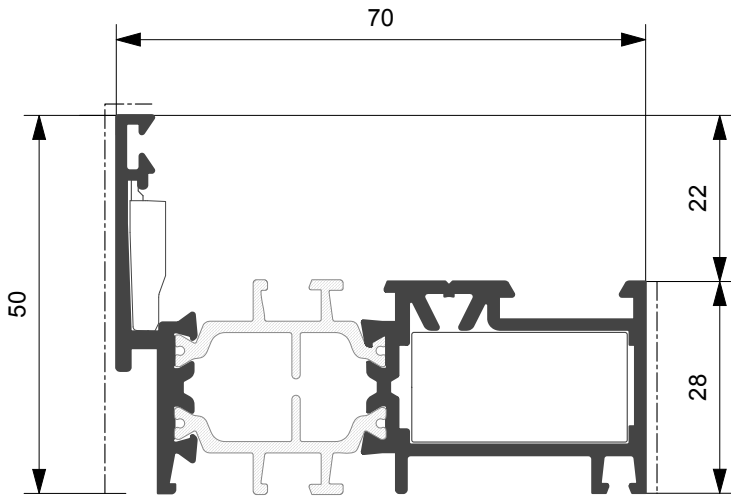

CX70.124HP

Kg/ml 1.214
--- mm. 78,0

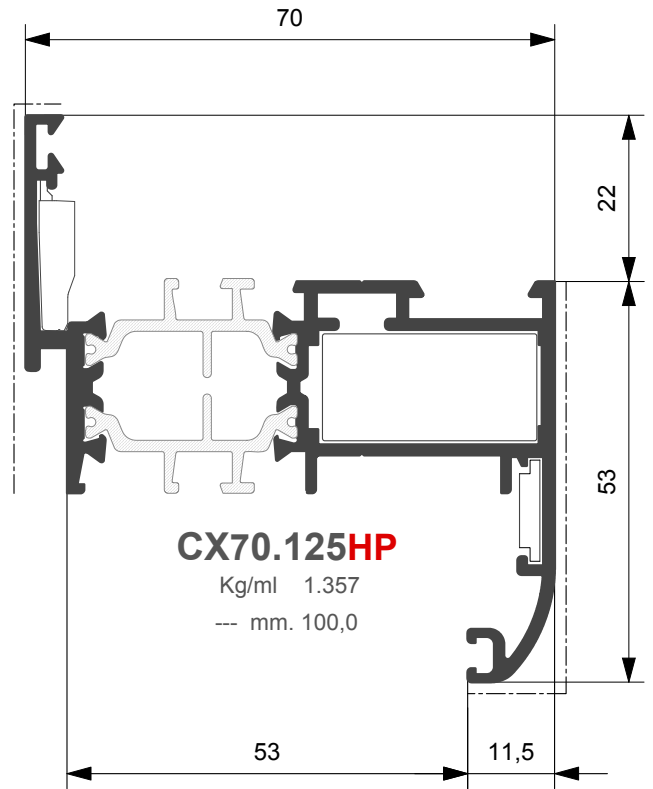

CX70.125HP

Kg/ml 1.357
--- mm. 100,0

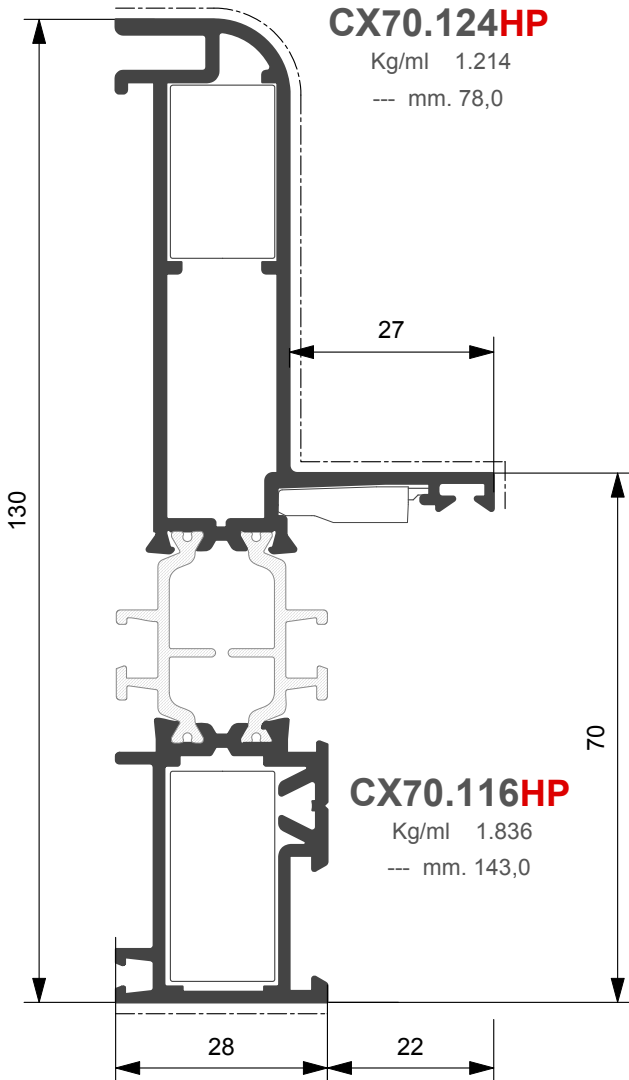

CX70.116HP

Kg/ml 1.836
--- mm. 143,0

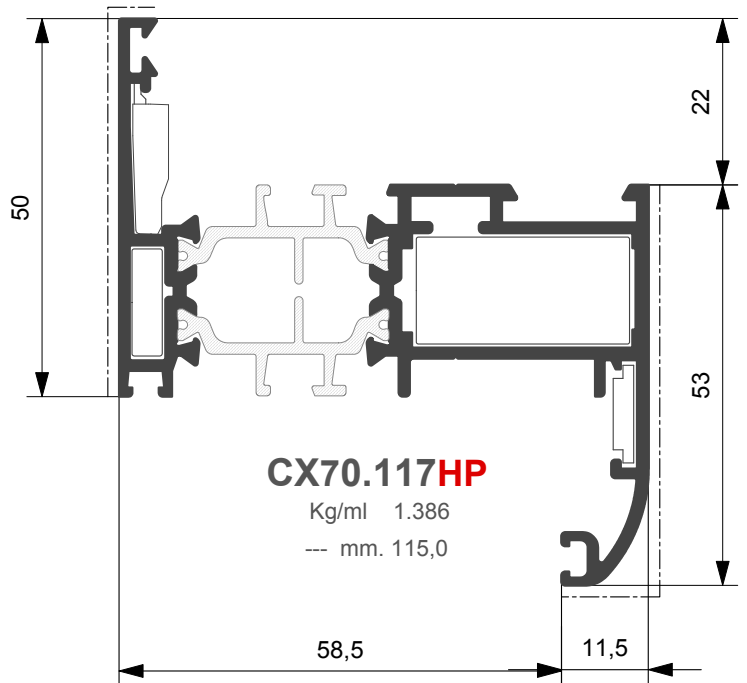

CX70.117HP

Kg/ml 1.386
--- mm. 115,0

Profilato	Squadretta esterna		Squadretta interna			Squadretta allineamento	
	Cianfrinare	Spinare	Bottone	Cianfrinare	Spinare	Esterna	Interna
CX70.116HP	ARX.13.SQ a bottone		ACX.01.SQ			ARX.15.SQ	
CX70.117HP	ARX.03.SQ	ARX.03.SQ + ARX.08.SQ	ACX.01.SQ	ACX.02.SQ	ACX.02.SQ + ARX.07.SQ	ARX.15.SQ	ARX.10.SQ
CX70.124HP			ACX.01.SQ	ACX.02.SQ	ACX.02.SQ + ARX.07.SQ	ARX.15.SQ	
CX70.125HP			ACX.01.SQ	ACX.02.SQ	ACX.02.SQ + ARX.07.SQ	ARX.15.SQ	ARX.10.SQ

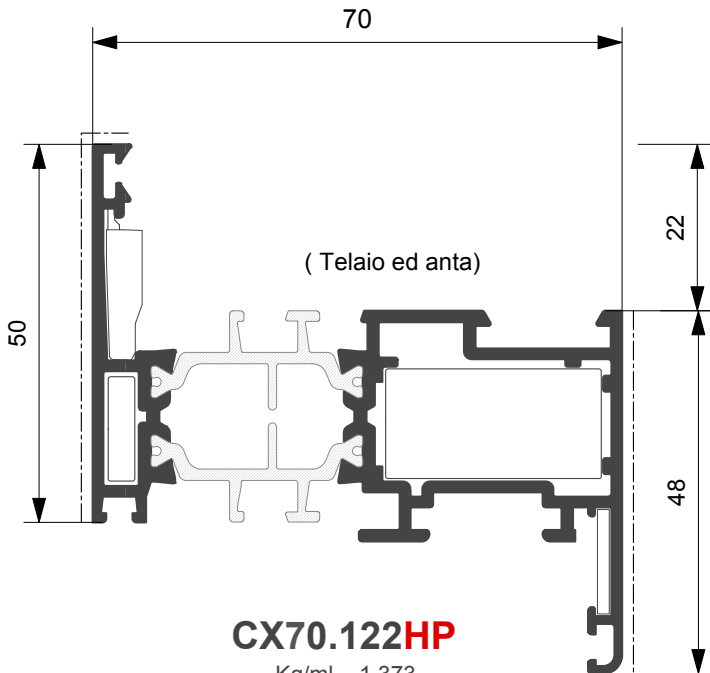

CX70.122HP
Kg/ml 1.373
--- mm. 98

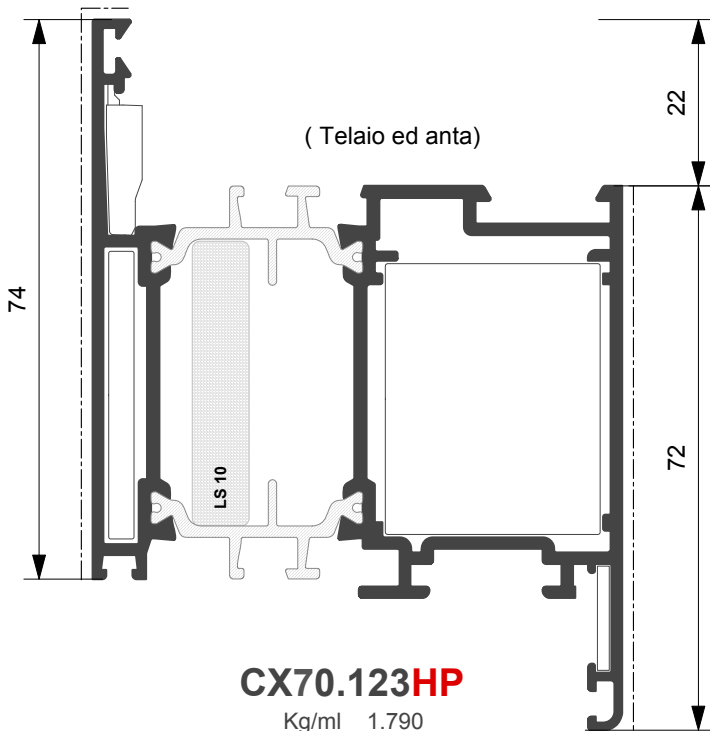

CX70.123HP
Kg/ml 1.790
--- mm. 146

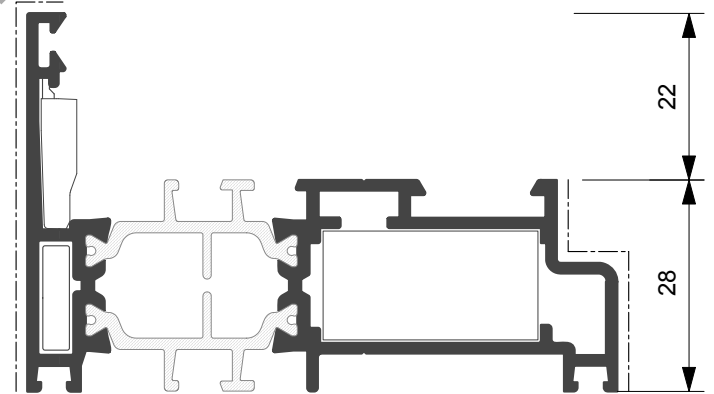

CX70.119HP
Kg/ml 1.275
--- mm. 86,0

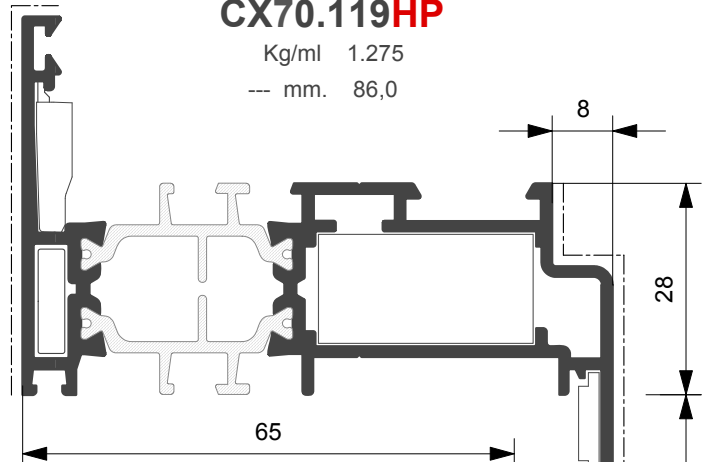

CX70.120HP
Kg/ml 1.449
--- mm. 111,0

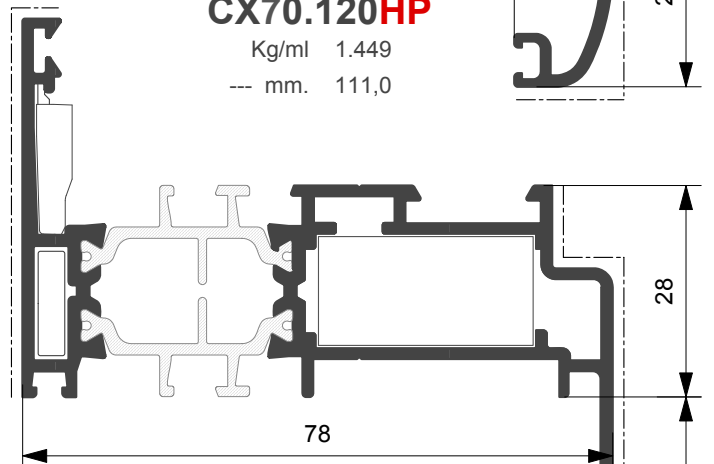

CX70.121HP
Kg/ml 1.531
--- mm. 126,0

Profilato	Squadretta esterna		Squadretta interna			Squadretta allineamento	
	Cianfrinare	Spinare	Bottone	Cianfrinare	Spinare	Esterna	Interna
CX70.119HP	ARX.03.SQ	ARX.03.SQ + ARX.08.SQ	ACX.01.SQ	ACX.02.SQ	ACX.02.SQ + ARX.07.SQ	ARX.15.SQ	
CX70.120HP	ARX.03.SQ	ARX.03.SQ + ARX.08.SQ	ACX.01.SQ	ACX.02.SQ	ACX.02.SQ + ARX.07.SQ	ARX.15.SQ	ARX.10.SQ
CX70.121HP	ARX.03.SQ	ARX.03.SQ + ARX.08.SQ	ACX.01.SQ	ACX.02.SQ	ACX.02.SQ + ARX.07.SQ	ARX.15.SQ	ARX.10.SQ
CX70.122HP	ARX.03.SQ	ARX.03.SQ + ARX.08.SQ	ACX.01.SQ	ACX.02.SQ	ACX.02.SQ + ARX.07.SQ	ARX.15.SQ	ARX.10.SQ
CX70.123HP	ARX.06.SQ	ARX.06.SQ + ARX.08.SQ	ACX.04.SQ	ACX.14.SQ	ACX.14.SQ	ARX.15.SQ	ARX.10.SQ

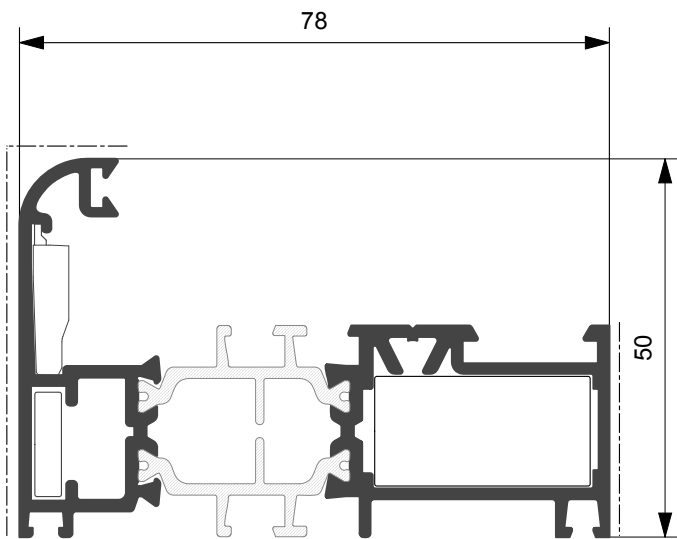

CX70.152HP

Kg/ml 1.389
--- mm. 86,0

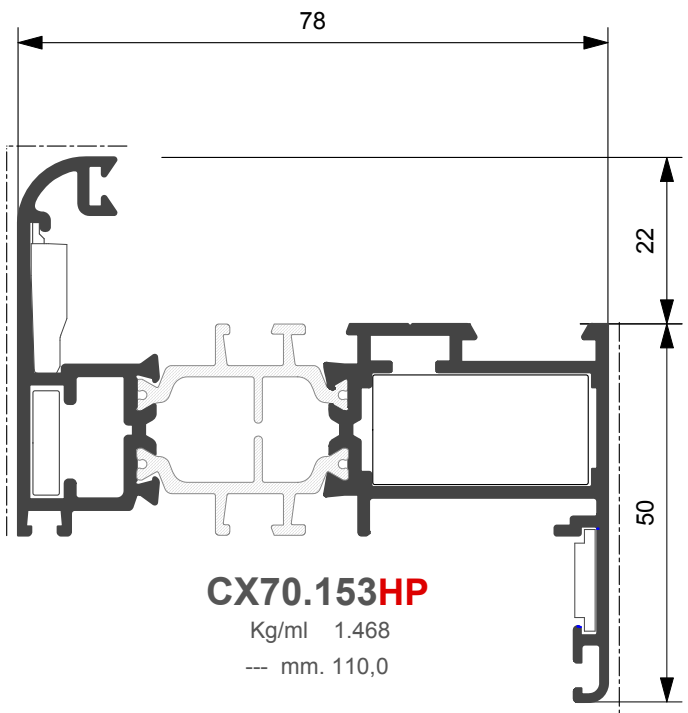

CX70.153HP

Kg/ml 1.468
--- mm. 110,0

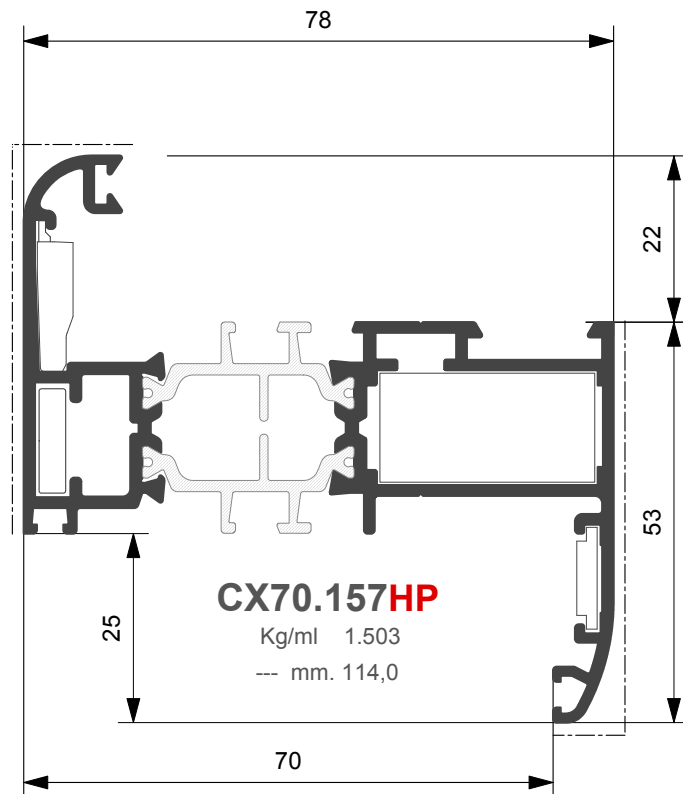

CX70.157HP

Kg/ml 1.503
--- mm. 114,0

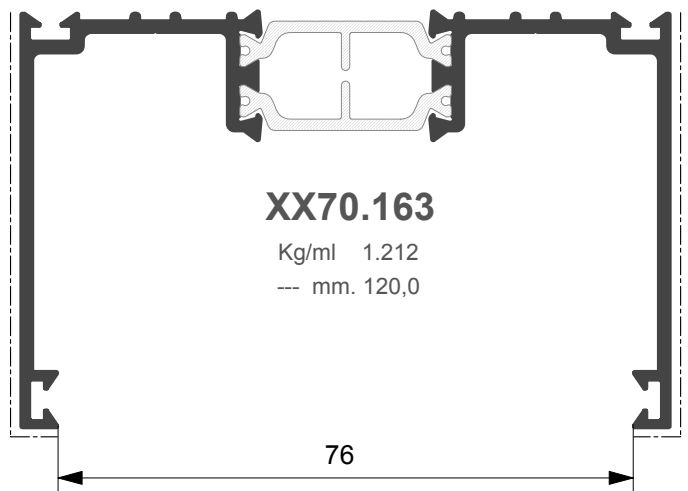

XX70.163

Kg/ml 1.212
--- mm. 120,0

Profilato	Squadretta esterna		Squadretta interna			Squadretta allineamento	
	Cianfrinare	Spinare	Bottone	Cianfrinare	Spinare	Esterna	Interna
CX70.152HP	ARX.03.SQ	ARX.03.SQ + ARX.08.SQ	ACX.01.SQ	ARX.02.SQ	ACX.02.SQ + ARX.07.SQ	ARX.15.SQ	
CX70.153HP	ARX.03.SQ	ARX.03.SQ + ARX.08.SQ	ACX.01.SQ	ARX.02.SQ	ACX.02.SQ + ARX.07.SQ	ARX.15.SQ	ARX.10.SQ
CX70.157HP	ARX.03.SQ	ARX.03.SQ + ARX.08.SQ	ACX.01.SQ	ARX.02.SQ	ACX.02.SQ + ARX.07.SQ	ARX.15.SQ	ARX.10.SQ

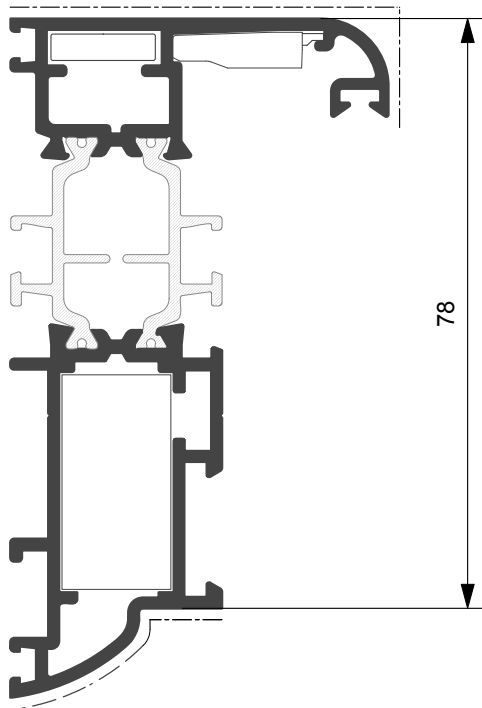

CX70.161HP

Kg/ml 1.455
--- mm. 96,0

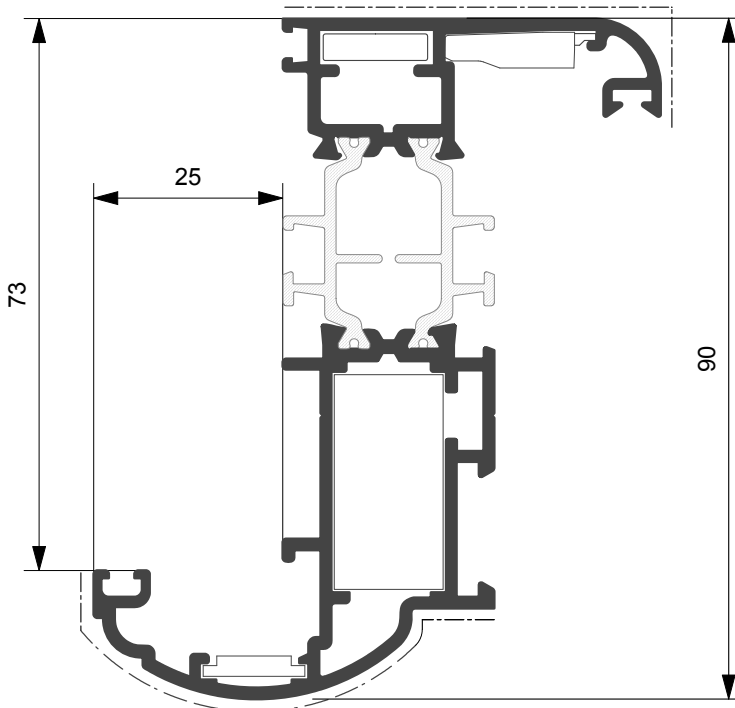

CX70.162HP

Kg/ml 1.632
--- mm. 131,0

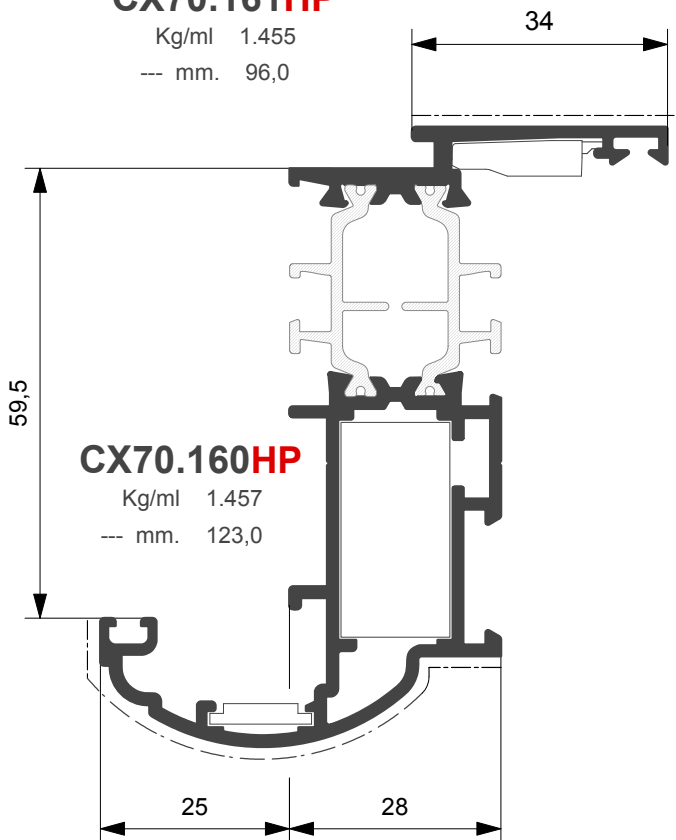

CX70.160HP

Kg/ml 1.457
--- mm. 123,0

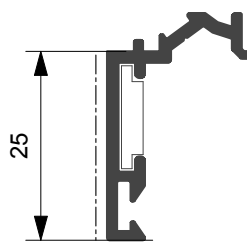

XX70.612

Kg/ml 0.245
--- mm. 25,0



XX60.635

Kg/ml 0.306
--- mm. 41,0

Profilato	Squadretta esterna		Squadretta interna			Squadretta allineamento	
	Cianfrinare	Spinare	Bottone	Cianfrinare	Spinare	Esterna	Interna
CX70.160HP			ACX.01.SQ	ARX.02.SQ	ACX.02.SQ + ARX.07.SQ	ARX.15.SQ	ARX.10.SQ
CX70.161HP	ARX.03.SQ	ARX.03.SQ + ARX.08.SQ	ACX.01.SQ	ARX.02.SQ	ACX.02.SQ + ARX.07.SQ	ARX.15.SQ	ARX.10.SQ
CX70.162HP	ARX.03.SQ	ARX.03.SQ + ARX.08.SQ	ACX.01.SQ	ARX.02.SQ	ACX.02.SQ + ARX.07.SQ	ARX.15.SQ	

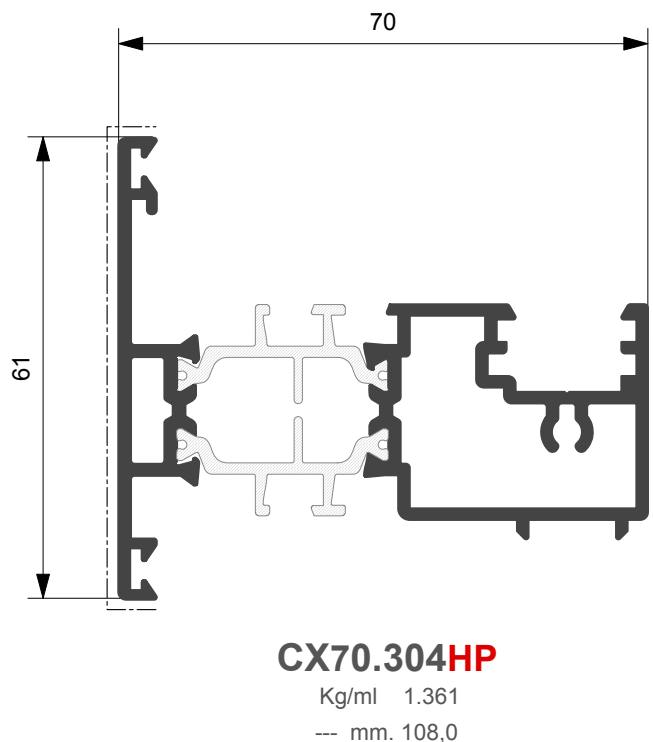
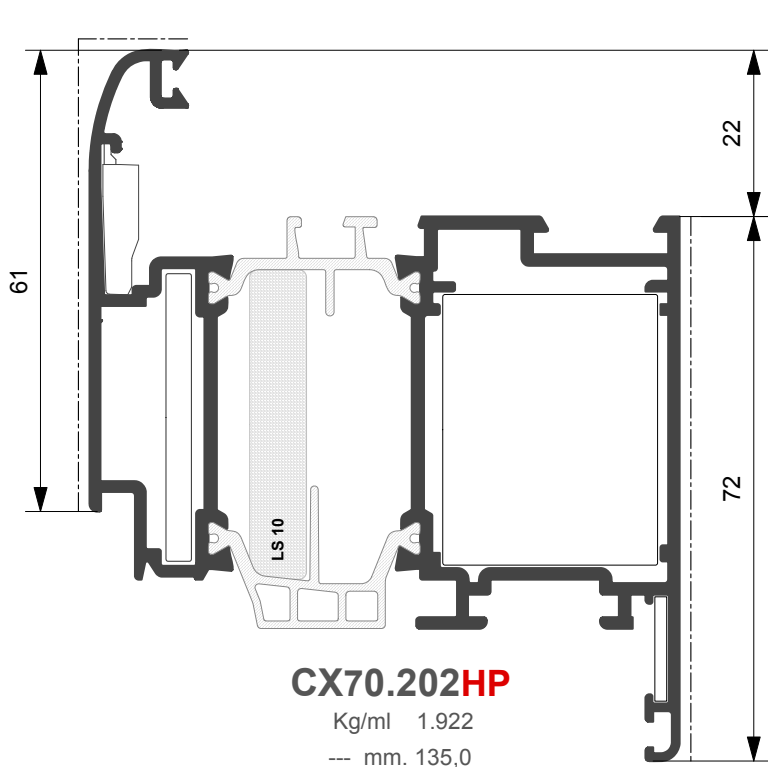
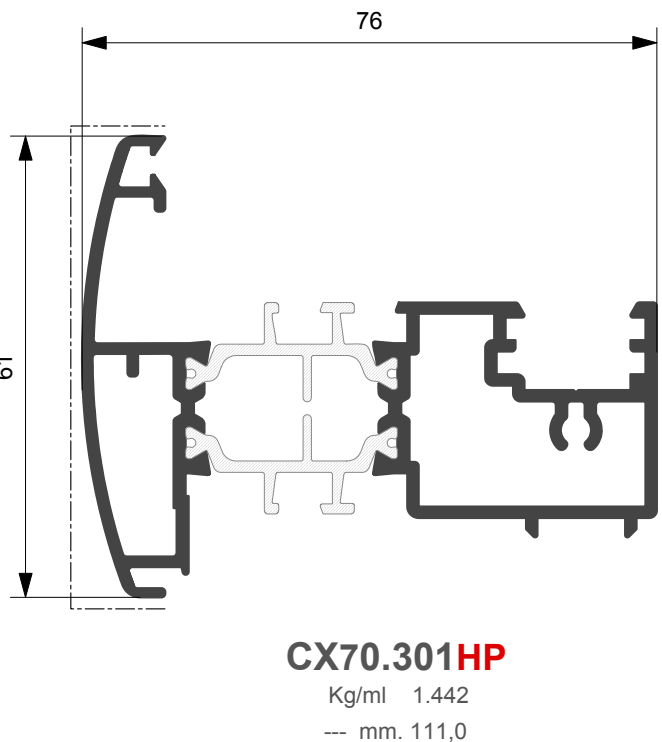
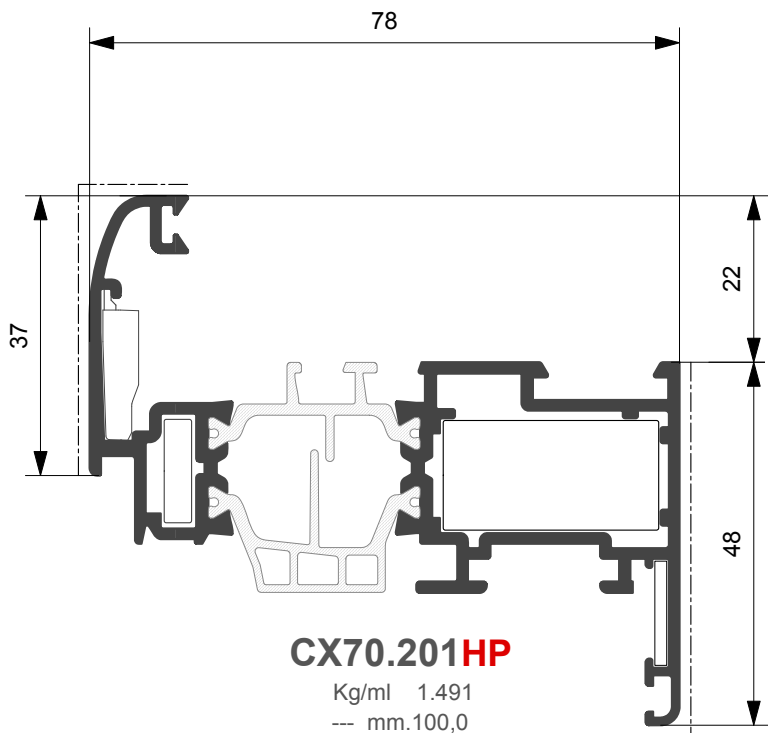

Profilato	Squadretta esterna		Squadretta interna			Squadretta allineamento	
	Cianfrinare	Spinare	Bottone	Cianfrinare	Spinare o Avvitare	Esterna	Interna
CX70.201HP	ARX.03.SQ	ARX.03.SQ + ARX.08.SQ	ACX.01.SQ	ACX.02.SQ	ACX.02.SQ + ARX.07.SQ	ARX.15.SQ	ARX.10.SQ
CX70.202HP	ARX.06.SQ	ARX.06.SQ + ARX.08.SQ	ACX.04.SQ	ACX.14.SQ	ACX.14.SQ	ARX.15.SQ	ARX.10.SQ

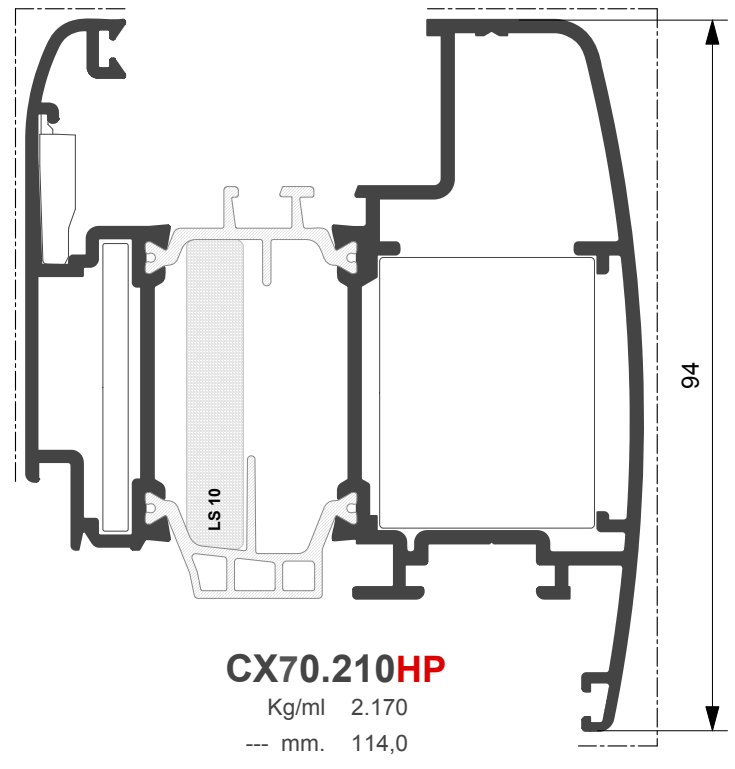
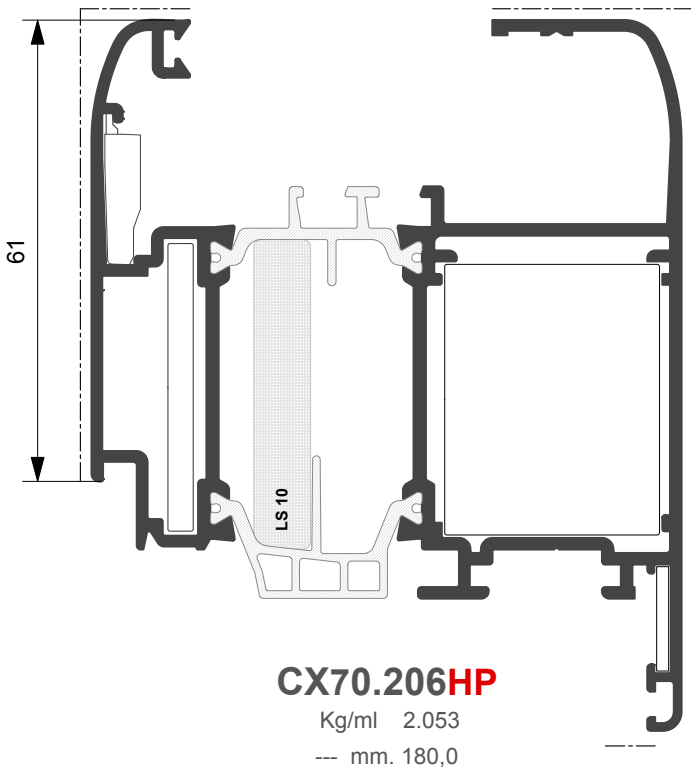
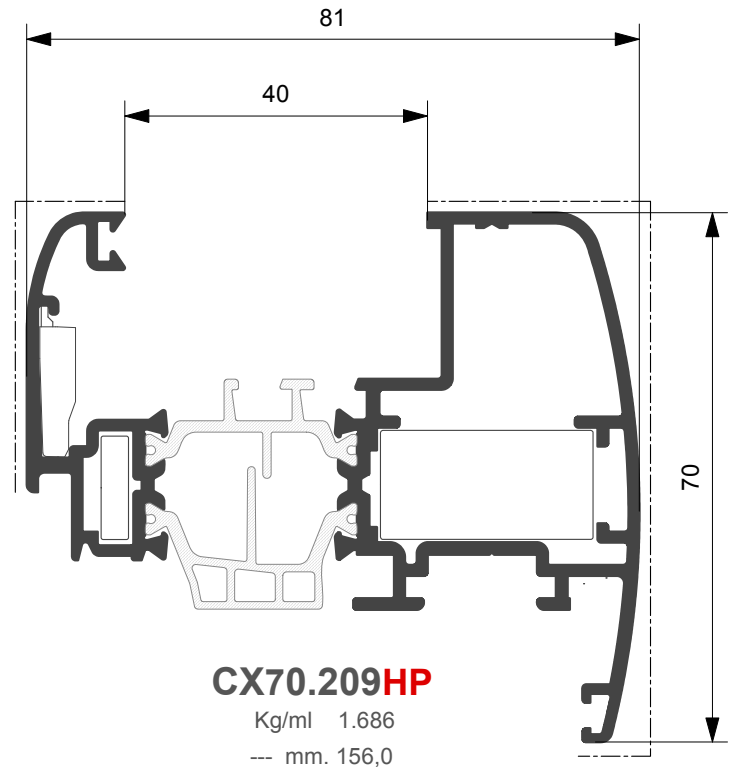
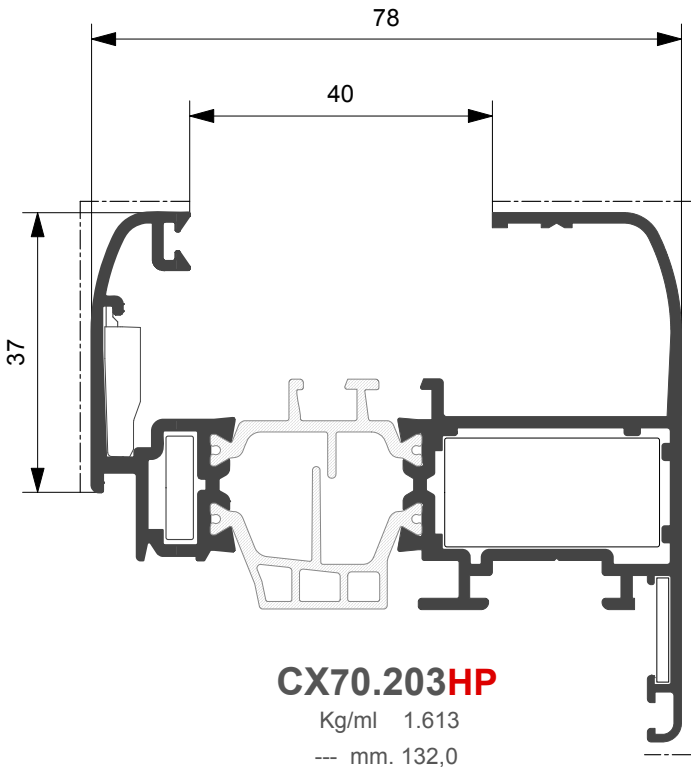

Profilato	Squadretta esterna		Squadretta interna			Squadretta allineamento	
	Cianfrinare	Spinare	Bottono	Cianfrinare	Spinare o Avvitare	Esterna	Interna
CX70.203HP		ARX.03.SQ + ARX.08.SQ	ACX.01.SQ		ACX.02.SQ + ARX.07.SQ	ARX.15.SQ	ARX.10.SQ
CX70.206HP		ARX.06.SQ + ARX.08.SQ	ACX.04.SQ		ACX.14.SQ	ARX.15.SQ	ARX.10.SQ
CX70.209HP		ARX.03.SQ + ARX.08.SQ	ACX.01.SQ		ACX.02.SQ + ARX.07.SQ	ARX.15.SQ	
CX70.210HP		ARX.06.SQ + ARX.08.SQ	ACX.04.SQ		ACX.14.SQ	ARX.15.SQ	

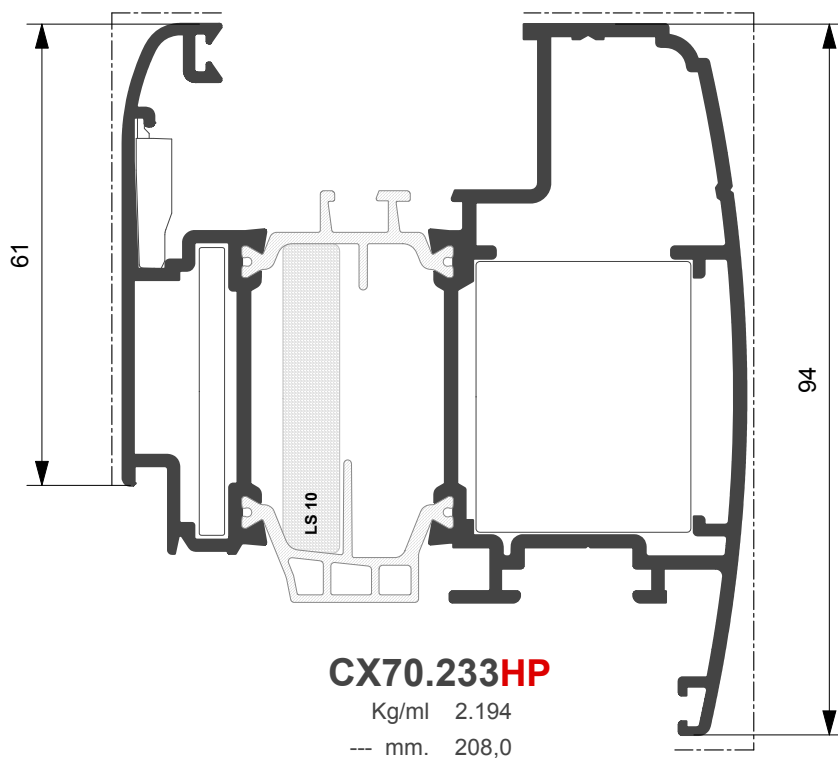
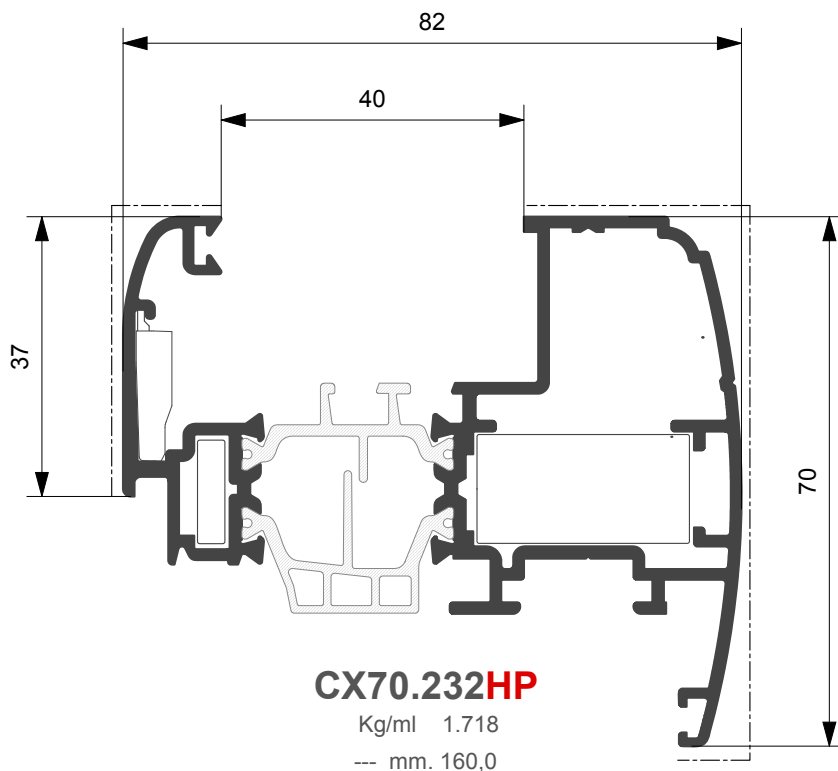

Profilato	Squadretta esterna		Squadretta interna			Squadretta allineamento	
	Cianfrinare	Spinare	Bottone	Cianfrinare	Spinare o Avvitare	Esterna	Interna
CX70.232HP	ARX.03.SQ	ARX.03.SQ + ARX.08.SQ	ACX.01.SQ		ACX.02.SQ + ARX.07.SQ	ARX.15.SQ	ARX.10.SQ
CX70.233HP	ARX.06.SQ	ARX.06.SQ + ARX.08.SQ	ACX.04.SQ		ACX.14.SQ	ARX.15.SQ	ARX.10.SQ

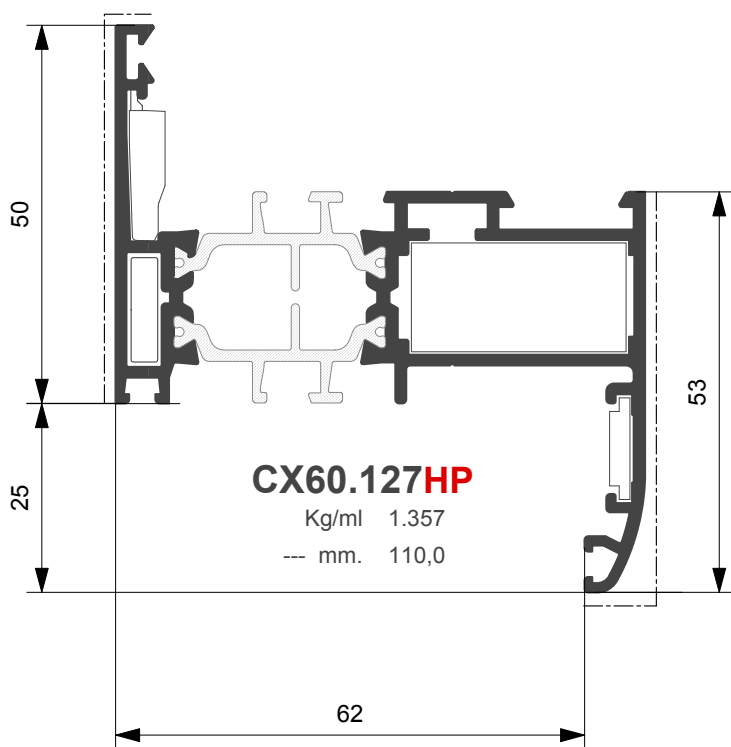
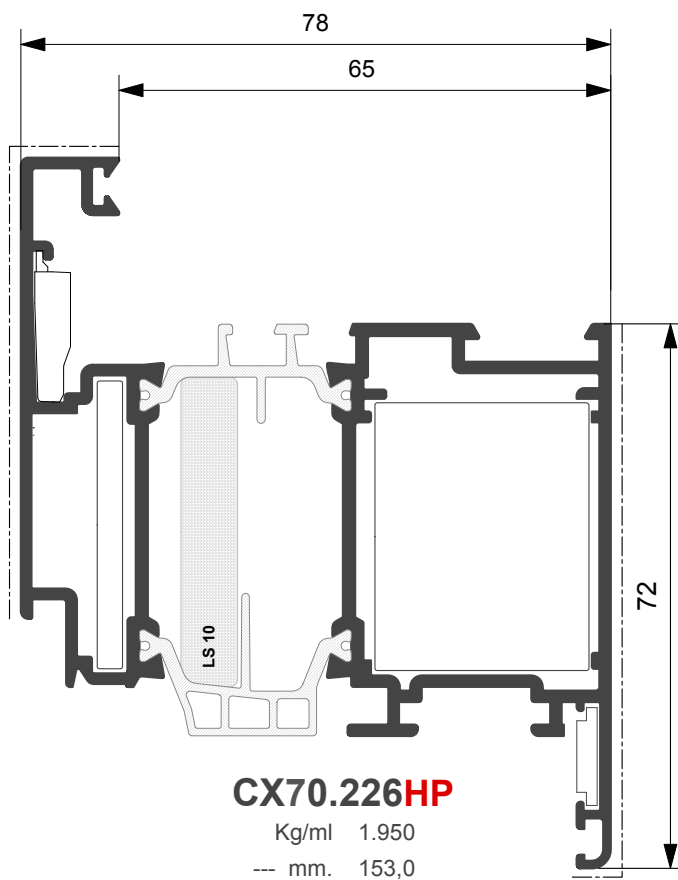
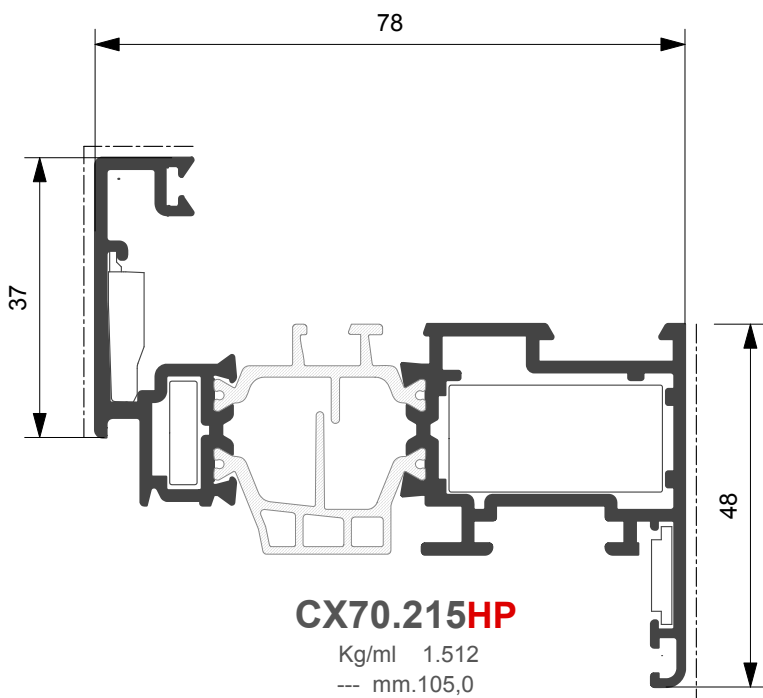

Profilato	Squadretta esterna		Squadretta interna			Squadretta allineamento	
	Cianfrinare	Spinare o Avvitare	Bottone	Cianfrinare	Spinare	Esterna	Interna
CX70.127HP	ARX.03.SQ	ARX.03.SQ + ARX.08.SQ	ACX.01.SQ		ACX.02.SQ + ARX.07.SQ	ARX.15.SQ	ARX.10.SQ
CX70.215HP	ARX.03.SQ	ARX.03.SQ + ARX.08.SQ	ACX.01.SQ		ACX.02.SQ + ARX.07.SQ	ARX.15.SQ	ARX.10.SQ
CX70.226HP	ARX.06.SQ	ARX.06.SQ + ARX.08.SQ	ACX.04.SQ	ACX.14.SQ	ACX.14.SQ	ARX.15.SQ	ARX.10.SQ

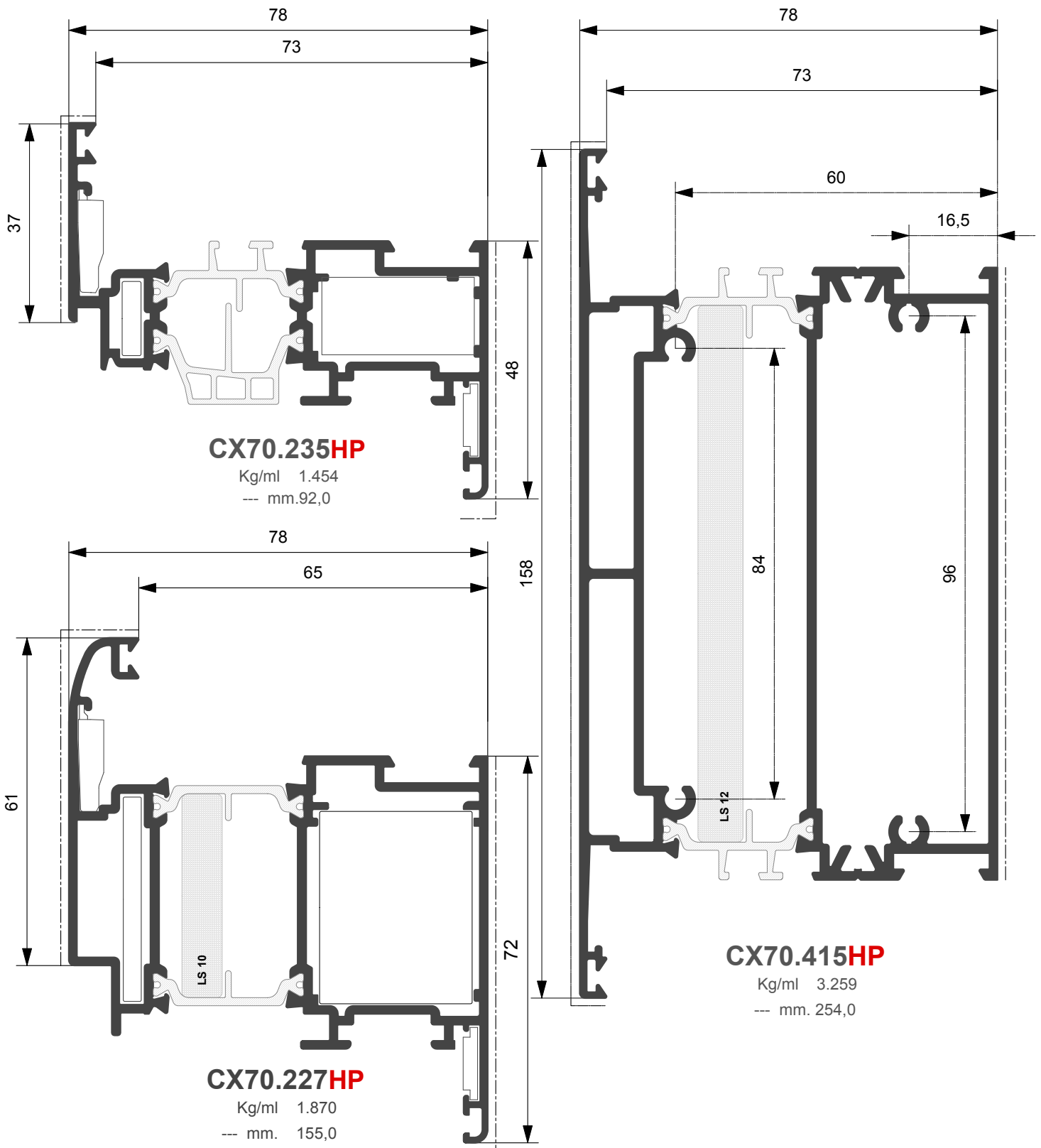

Profilato	Squadretta esterna		Squadretta interna			Squadretta allineamento	
	Cianfrinare	Spinare o Avvitare	Bottono	Cianfrinare	Spinare	Esterna	Interna
CX70.227HP	ARX.06.SQ	ARX.06.SQ + ARX.08.SQ	ACX.04.SQ	ACX.14.SQ	ACX.14.SQ	ARX.15.SQ	ARX.10.SQ
CX70.235HP	ARX.03.SQ	ARX.03.SQ + ARX.08.SQ	ACX.01.SQ		ACX.02.SQ + ARX.07.SQ	ARX.15.SQ	ARX.10.SQ



Ferramenta a nastro

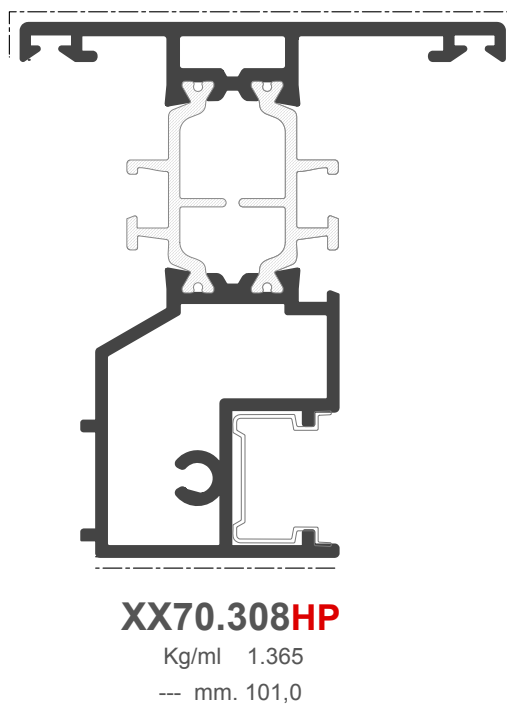
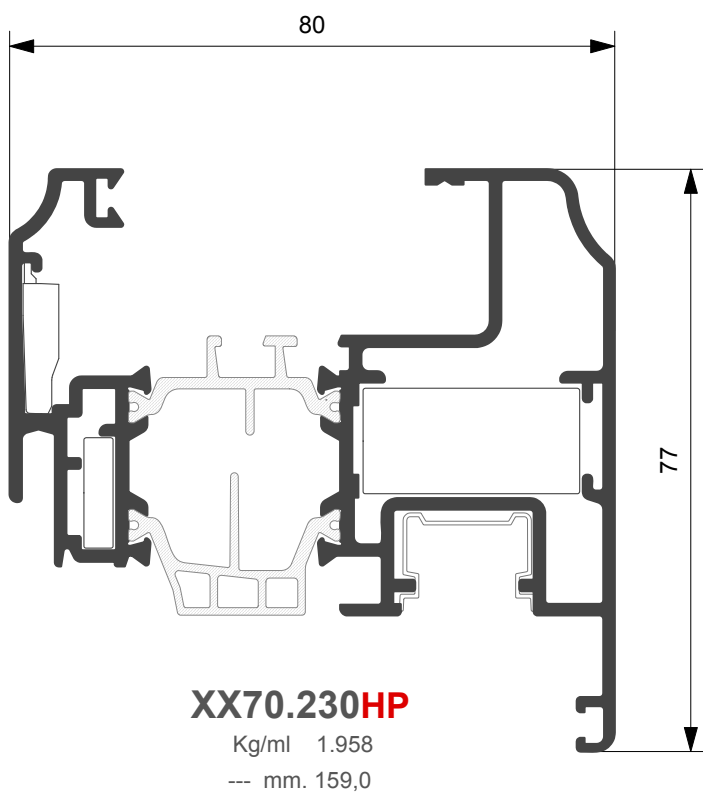
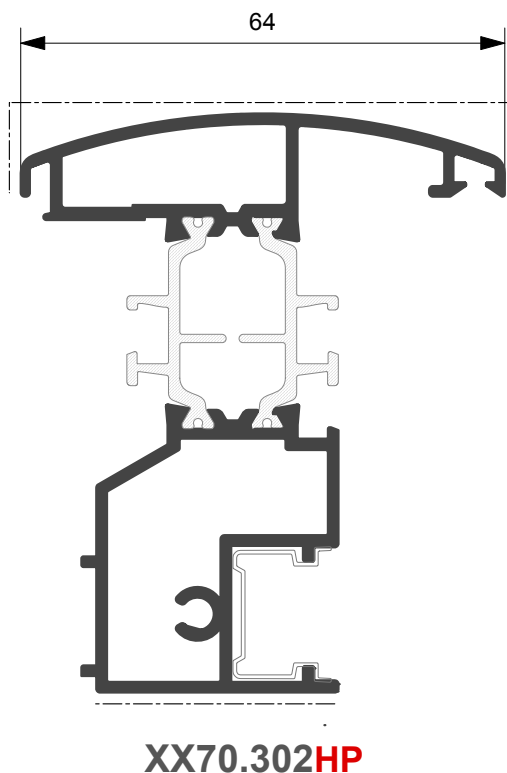
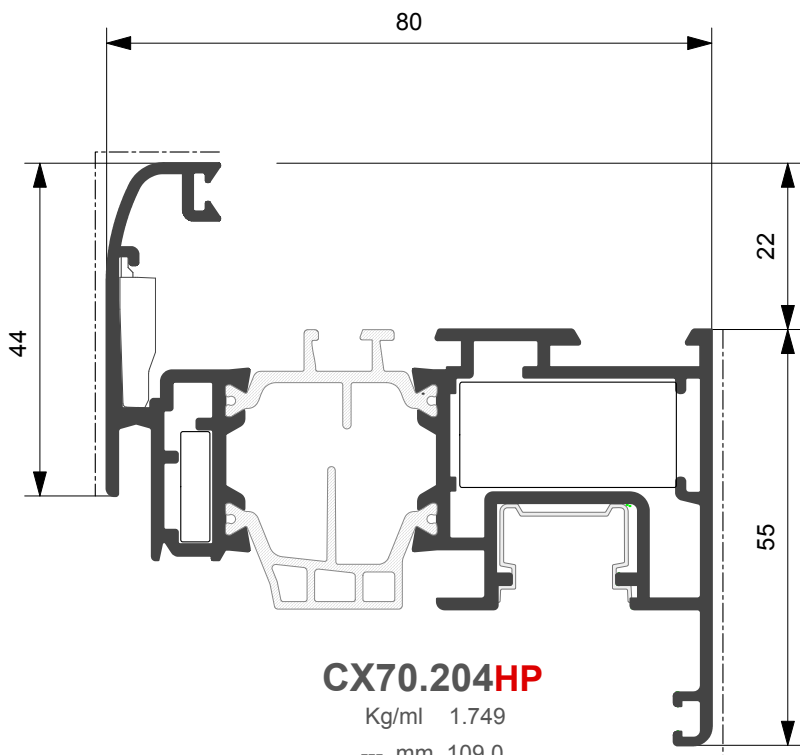

Profilato	Squadretta esterna		Squadretta interna			Squadretta allineamento	
	Cianfrinare	Spinare	Bottone	Cianfrinare	Spinare	Esterna	Interna
CX70.204HP	ARX.03.SQ	ARX.03.SQ + ARX.08.SQ	ACX.01.SQ	ACX.02.SQ	ACX.02.SQ + ARX.07.SQ	ARX.15.SQ	
XX70.230HP	ARX.03.SQ	ARX.03.SQ + ARX.08.SQ	ACX.01.SQ	ACX.02.SQ	ACX.02.SQ + ARX.07.SQ	ARX.15.SQ	

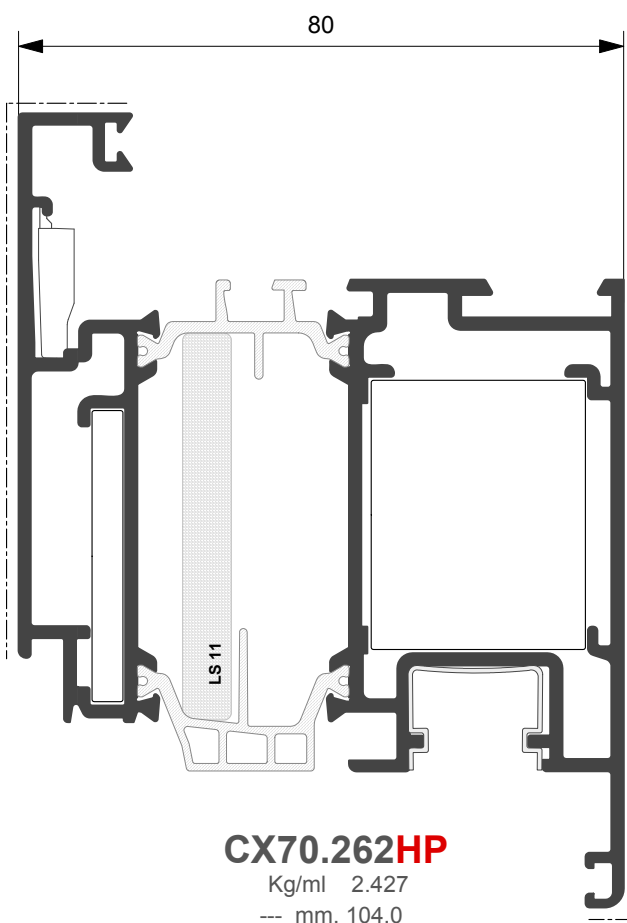
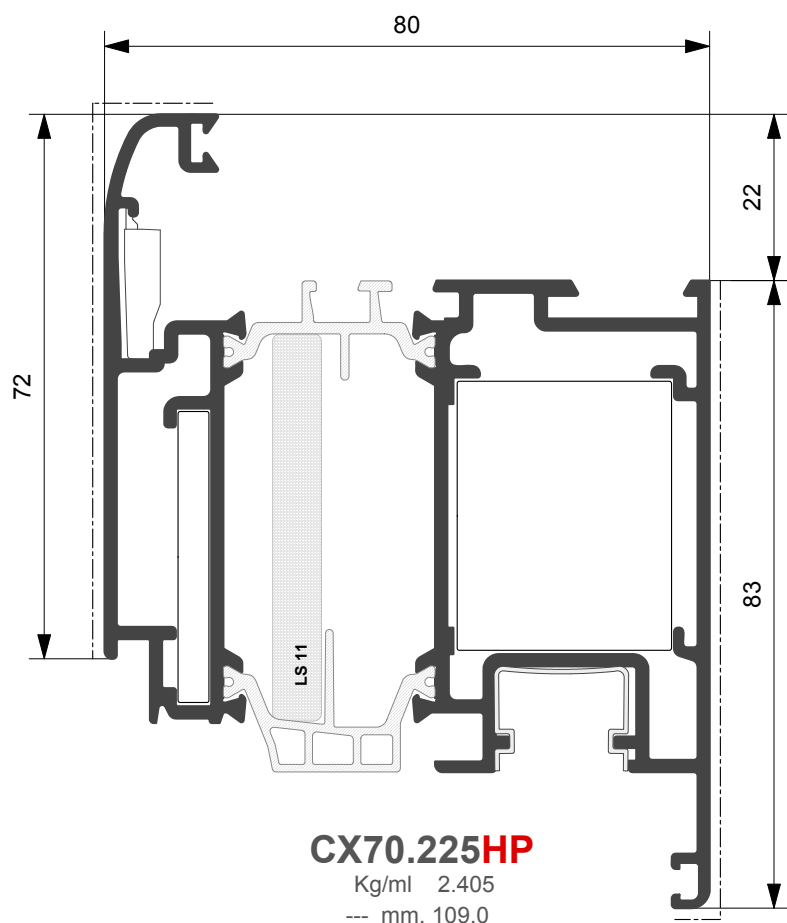
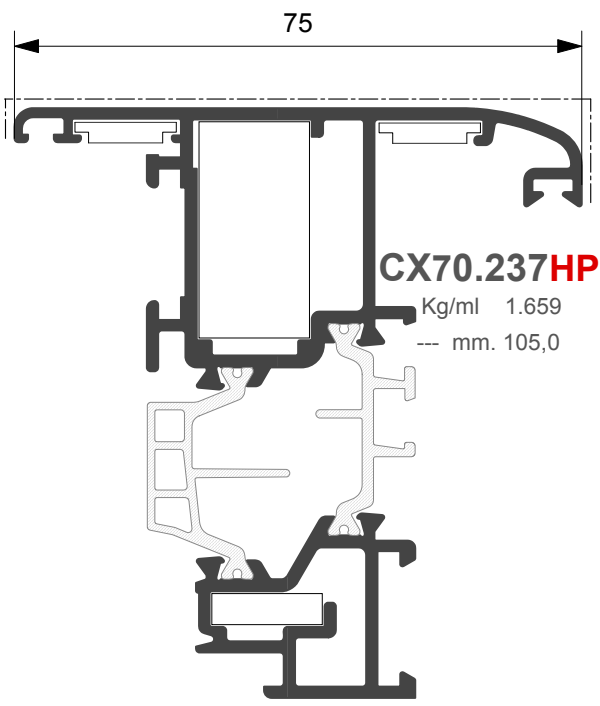
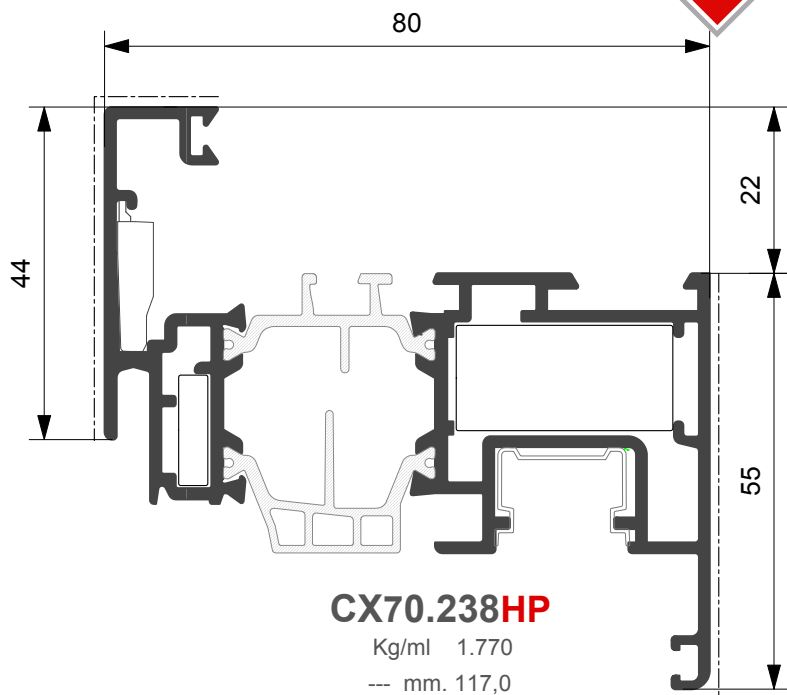

Profilato	Squadretta esterna		Squadretta interna			Squadretta allineamento	
	Cianfrinare	Spinare	Bottone	Cianfrinare	Spinare	Esterna	Interna
CX70.225HP	ARX.06.SQ	ARX.06.SQ + ARX.08.SQ	ACX.04.SQ		ACX.14.SQ	ARX.15.SQ	
CX70.237HP	ARX.03.SQ	ARX.03.SQ + ARX.08.SQ	ACX.01.SQ	ACX.02.SQ	ACX.02.SQ + ARX.07.SQ	ARX.15.SQ	
CX70.238HP	ARX.03.SQ	ARX.03.SQ + ARX.08.SQ	ACX.01.SQ	ACX.02.SQ	ACX.02.SQ + ARX.07.SQ	ARX.10.SQ	
CX70.262HP	ARX.06.SQ	ARX.06.SQ + ARX.08.SQ	ACX.04.SQ		ACX.14.SQ	ARX.15.SQ	



Ante sormonto 10 mm.

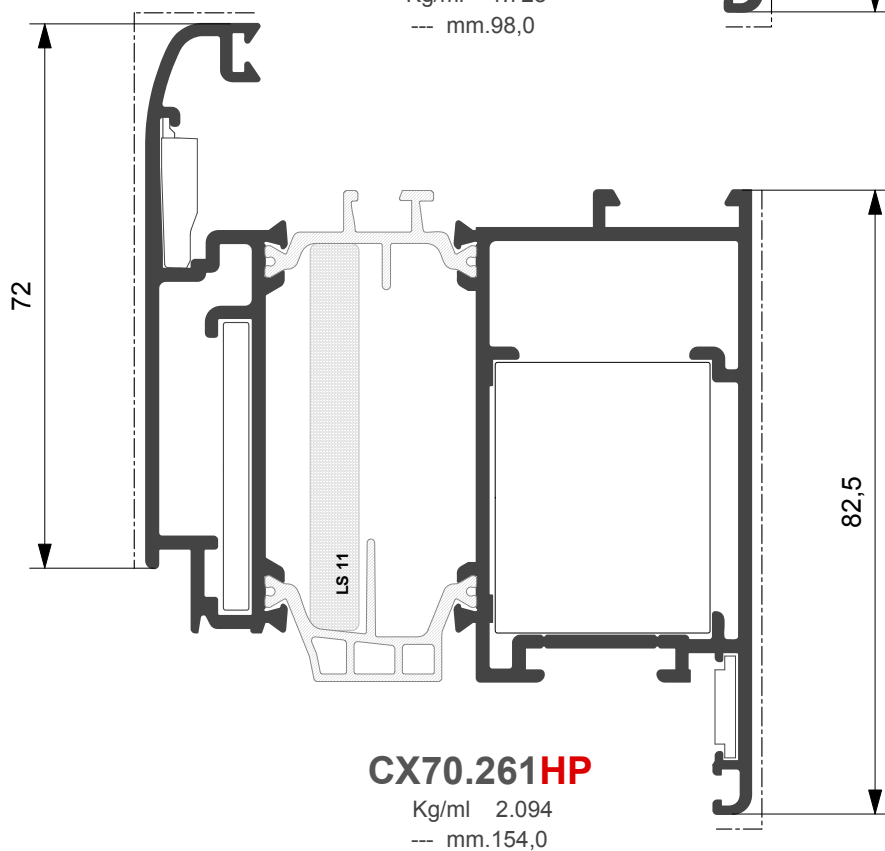
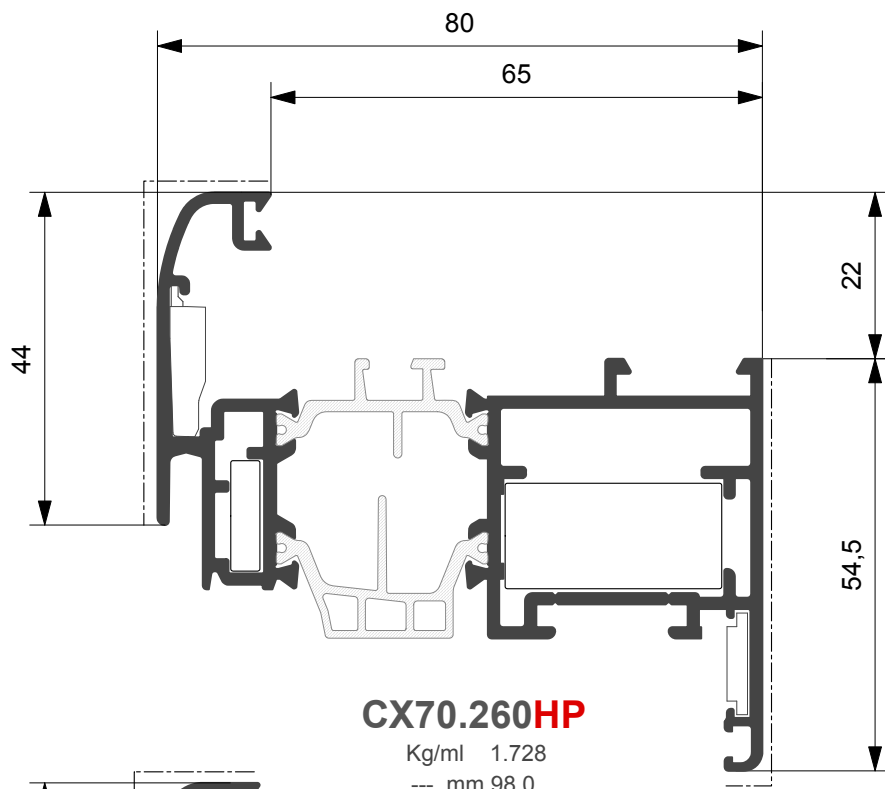

Profilato	Squadretta esterna		Squadretta interna			Squadretta allineamento	
	Cianfrinare	Spinare o Avvitare	Bottone	Cianfrinare	Spinare	Esterna	Interna
CX70.260HP	ARX.03.SQ	ARX.03.SQ + ARX.08.SQ	ACX.01.SQ		ACX.02.SQ + ARX.07.SQ	ARX.15.SQ	ARX.10.SQ
CX70.261HP	ARX.06.SQ	ARX.06.SQ + ARX.08.SQ	ACX.04.SQ	ACX.14.SQ	ACX.14.SQ	ARX.15.SQ	ARX.10.SQ

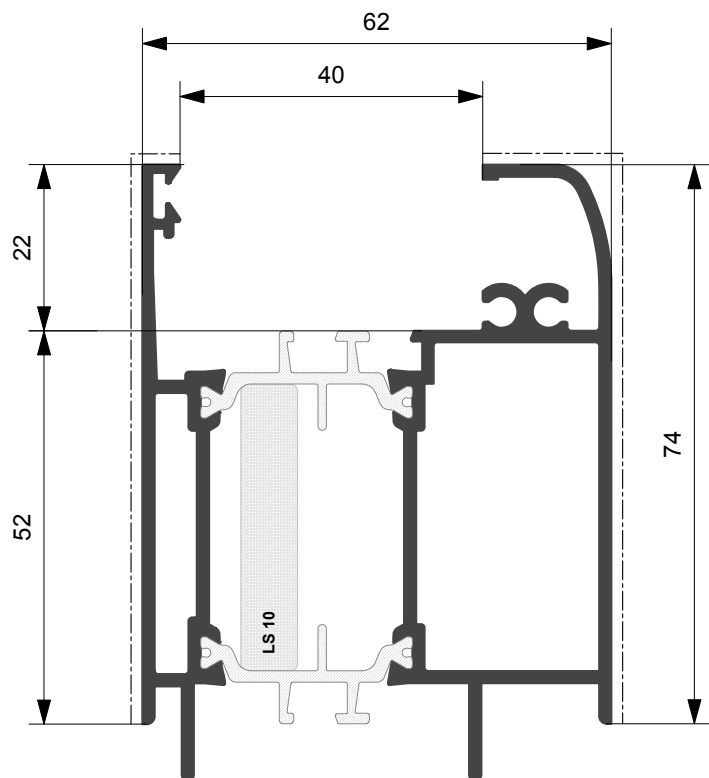

XX70.407HP

Kg/ml 1.840
--- mm. 162,0

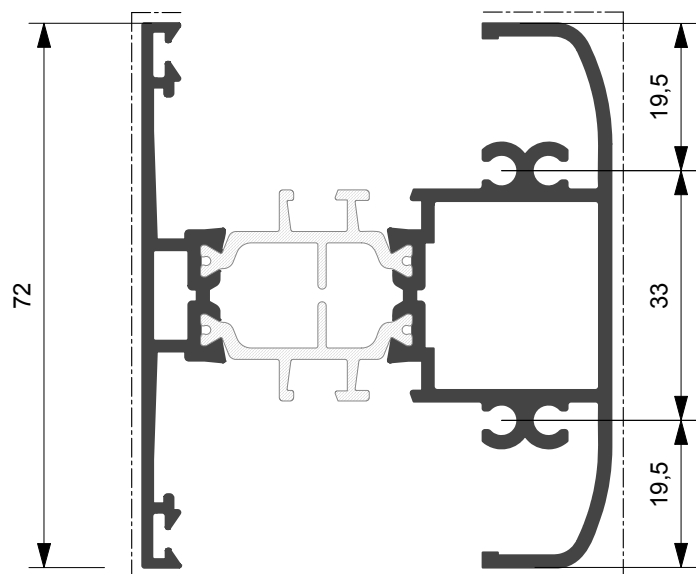

XX70.405HP

Kg/ml 1.678
--- mm. 1700

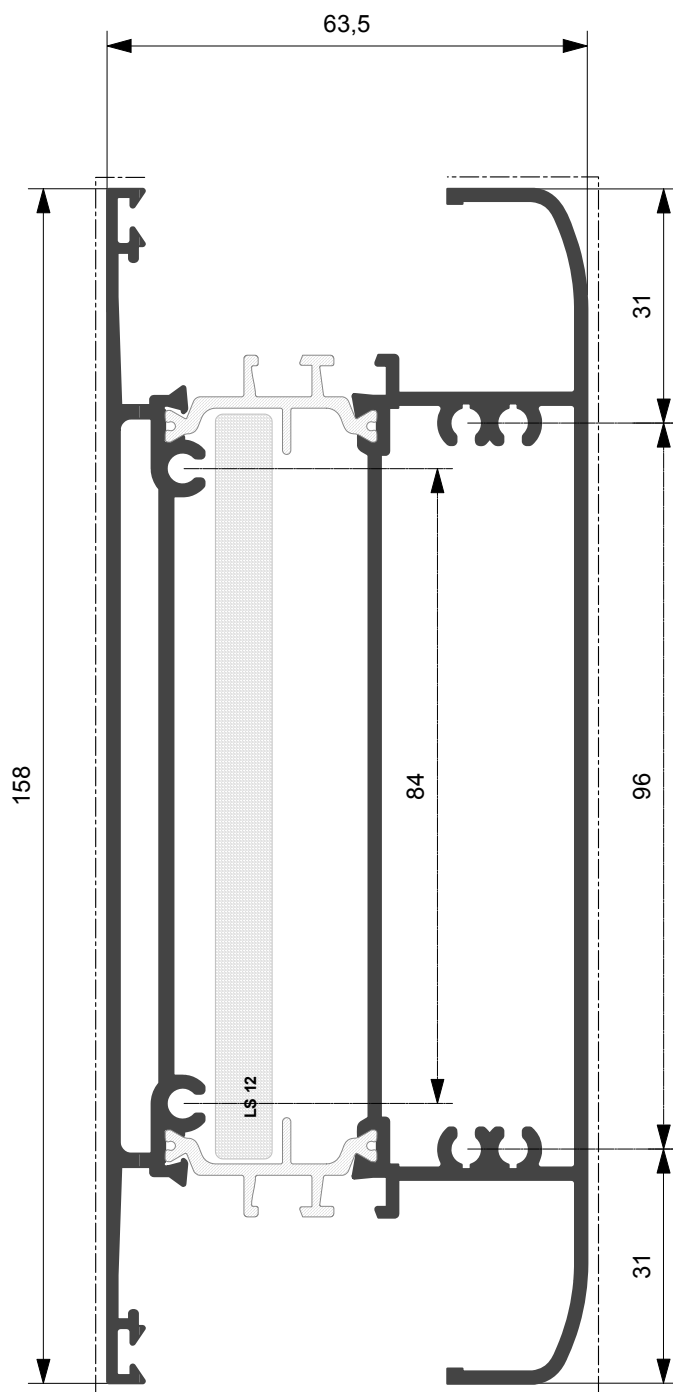

XX70.406HP

Kg/ml 3.334
--- mm. 332,0

Profilato	Squadretta esterna		Squadretta interna			Squadretta allineamento	
	Cianfrinare	Spinare	Bottono	Cianfrinare	Spinare	Esterna	Interna

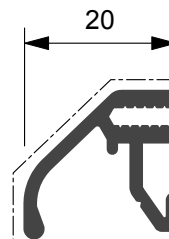
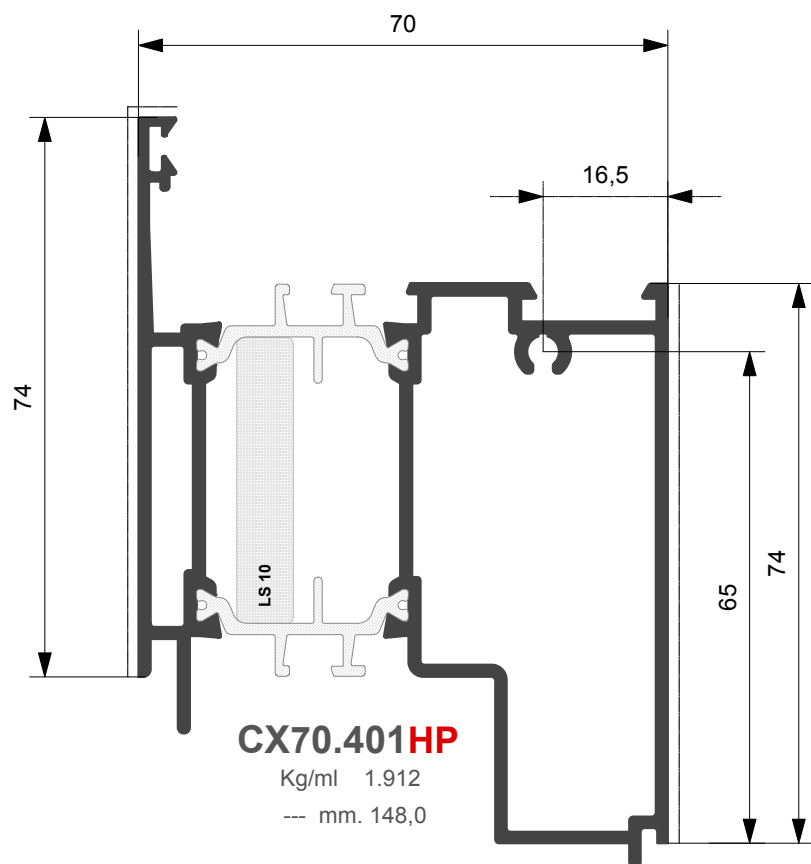

XX70.601
Kg/ml 0.269
--- mm. 28,0

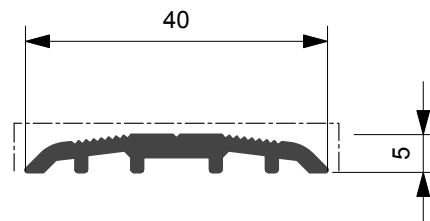

XX70.603
Kg/ml 0.275
--- mm. 40,0

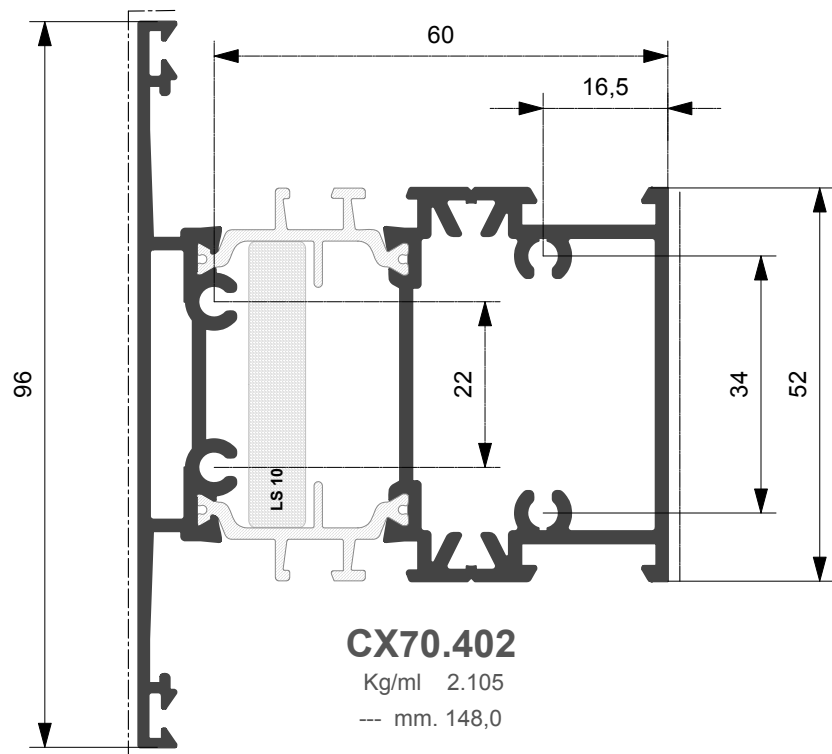

XX70.602
Kg/ml 0.372
--- mm. 22,0

Profilato	Squadretta esterna		Squadretta interna			Squadretta allineamento	
	Cianfrinare	Spinare	Bottone	Cianfrinare	Spinare	Esterna	Interna

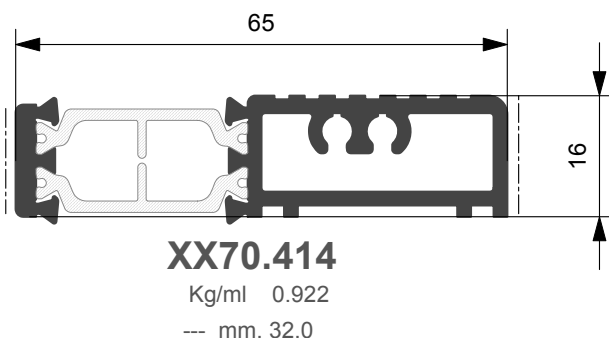
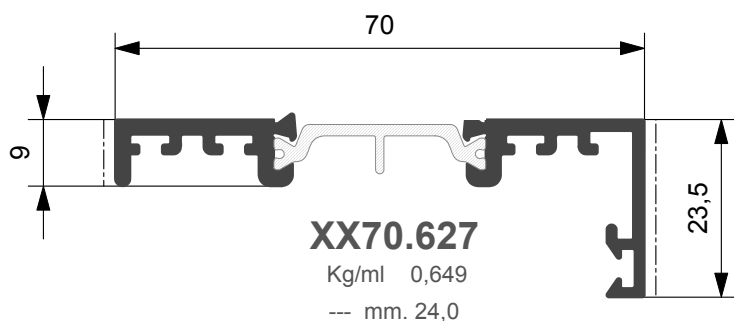
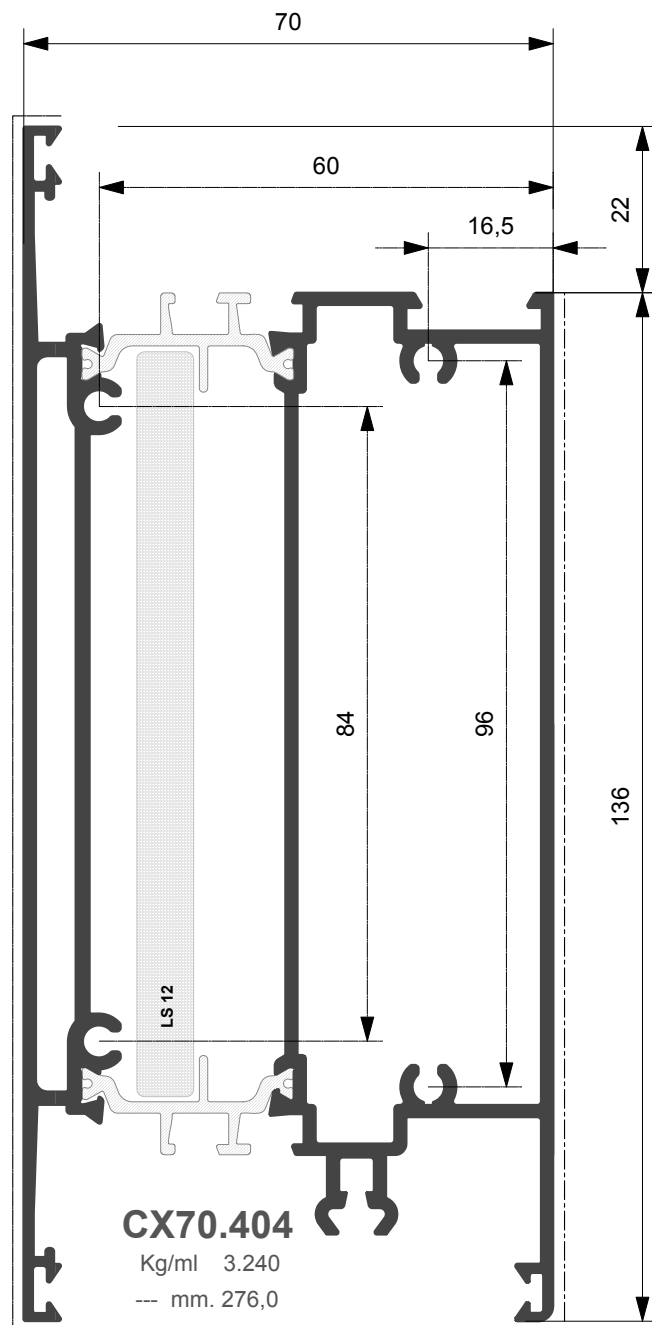
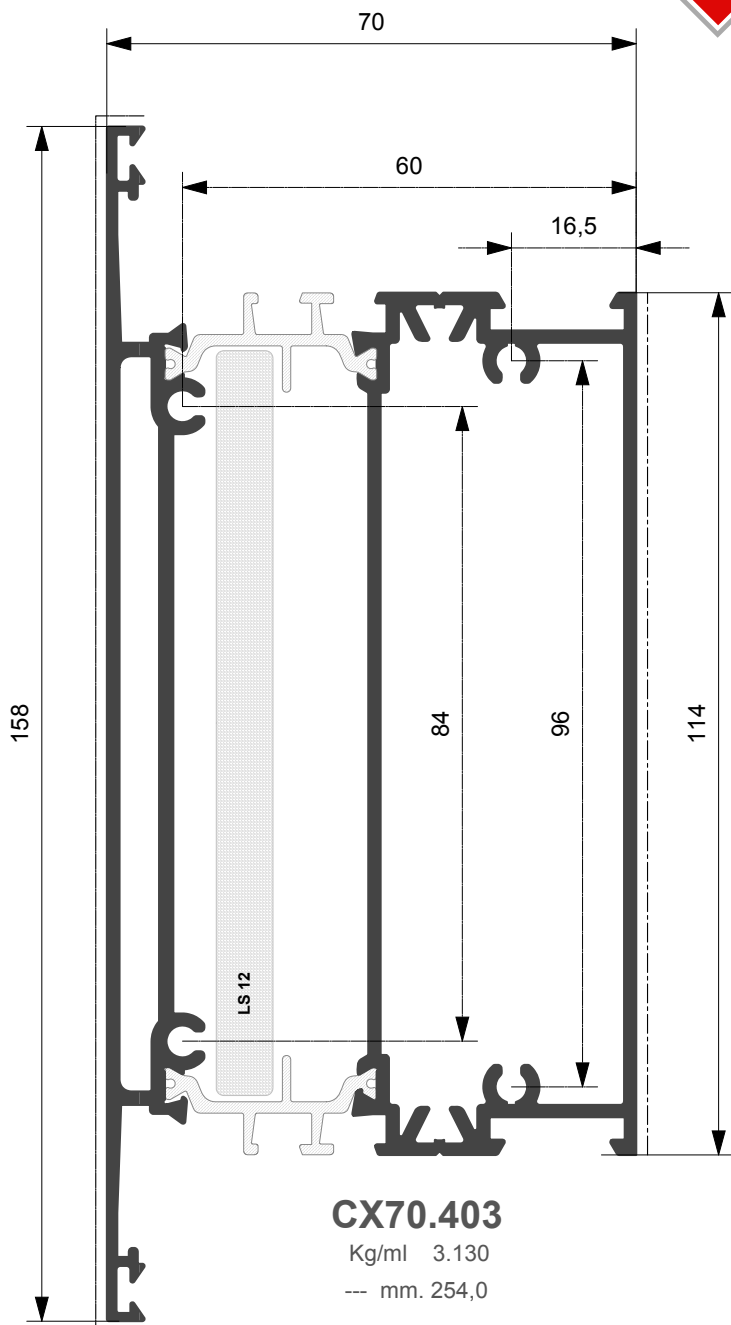

Profilato	Squadretta esterna		Squadretta interna			Squadretta allineamento	
	Cianfrinare	Spinare	Bottone	Cianfrinare	Spinare	Esterna	Interna

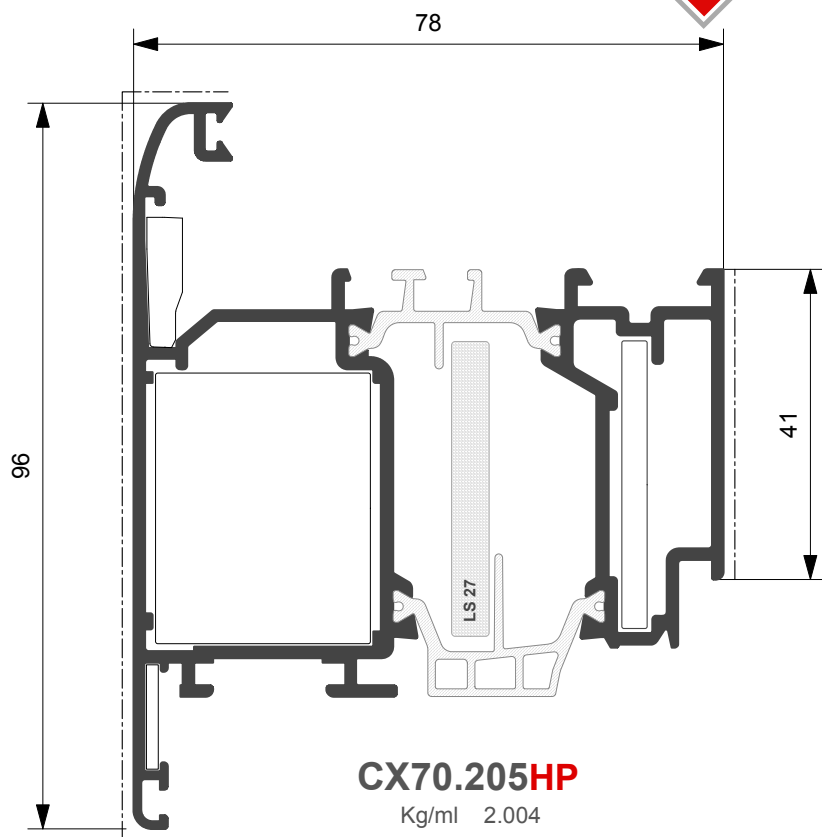

CX70.205HP

Kg/ml 2.004

--- mm. 147,0

100

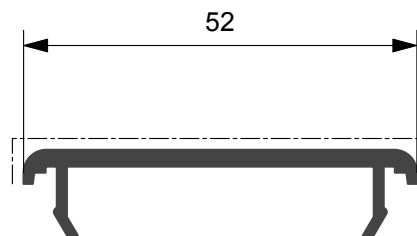

RX70.609

Kg/ml 0,393

--- mm. 55,0

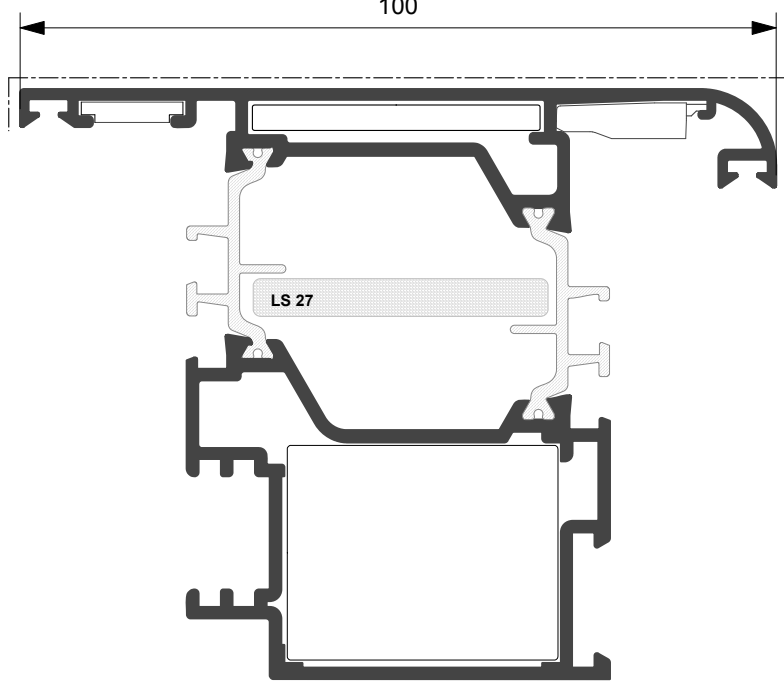

CX70.207HP

Kg/ml 2.075

--- mm. 155,0

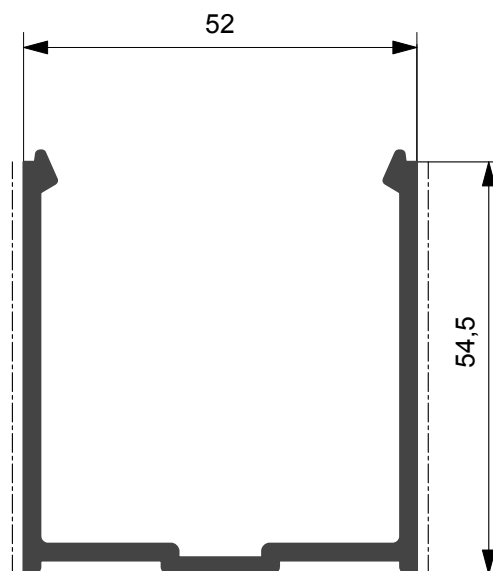

RX70.610

Kg/ml 0,994

--- mm. 109,0

Profilato	Squadretta esterna		Squadretta interna			Squadretta allineamento	
	Cianfrinare	Spinare	Bottone	Cianfrinare	Spinare	Esterna	Interna
CX70.205HP	ARX.06.SQ	ARX.06.SQ + ARX.08.SQ	ACX.04.SQ			ARX.09.SQ	ARX.10.SQ
CX70.207HP	ARX.06.SQ		ACX.04.SQ			ARX.09.SQ	ARX.10.SQ

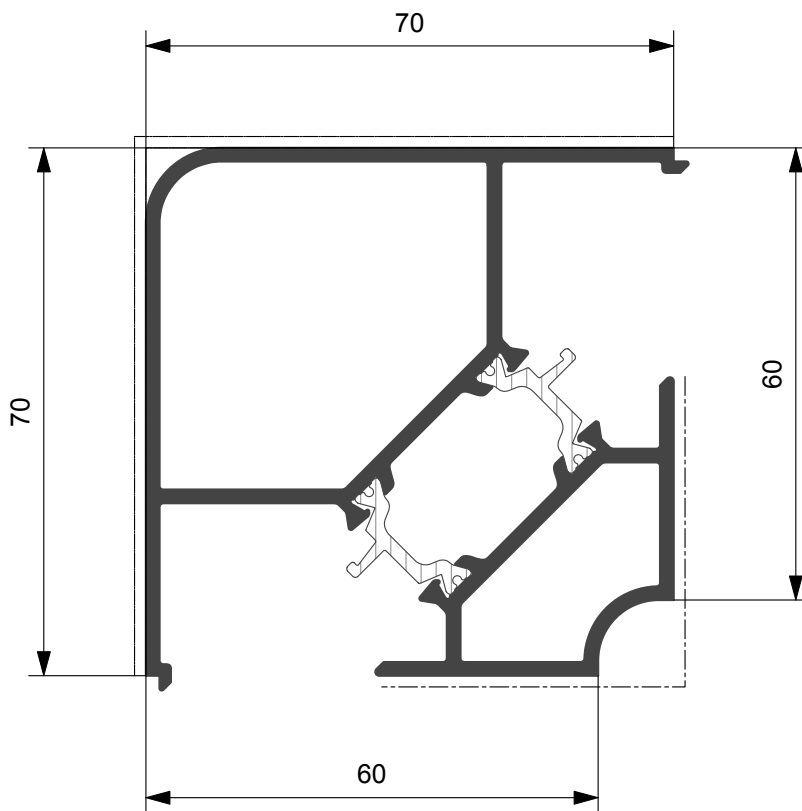

XX70.613

Kg/ml 1,885
--- mm. 215,0

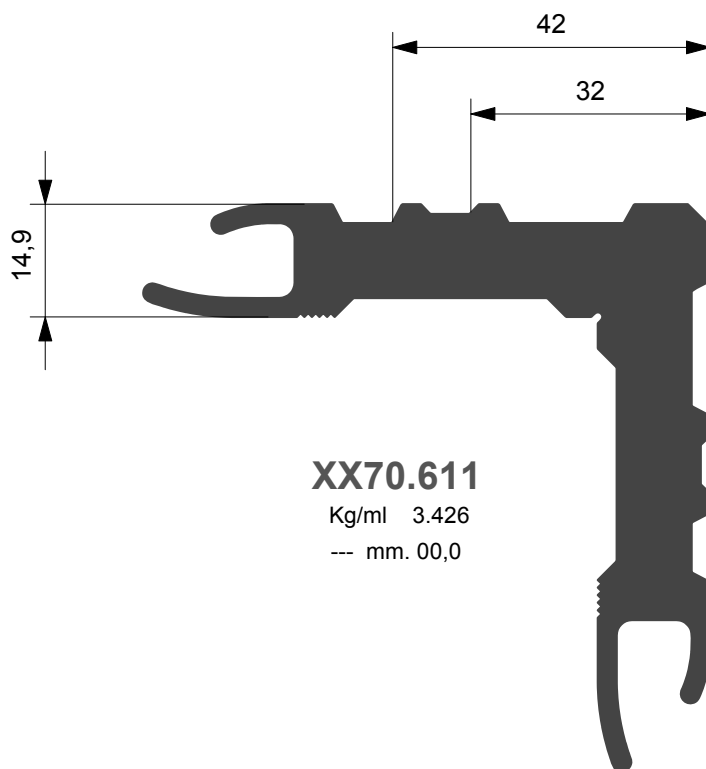

XX70.611

Kg/ml 3.426
--- mm. 00,0

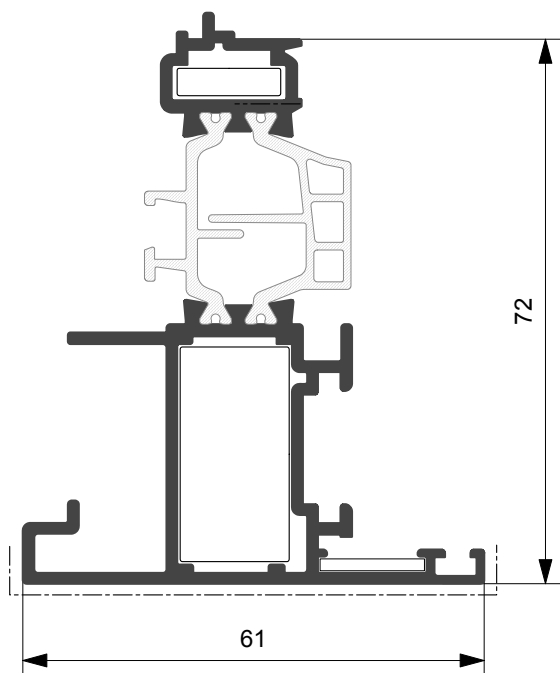

CX70.303HP

Kg/ml 1.311

--- mm. 64,0

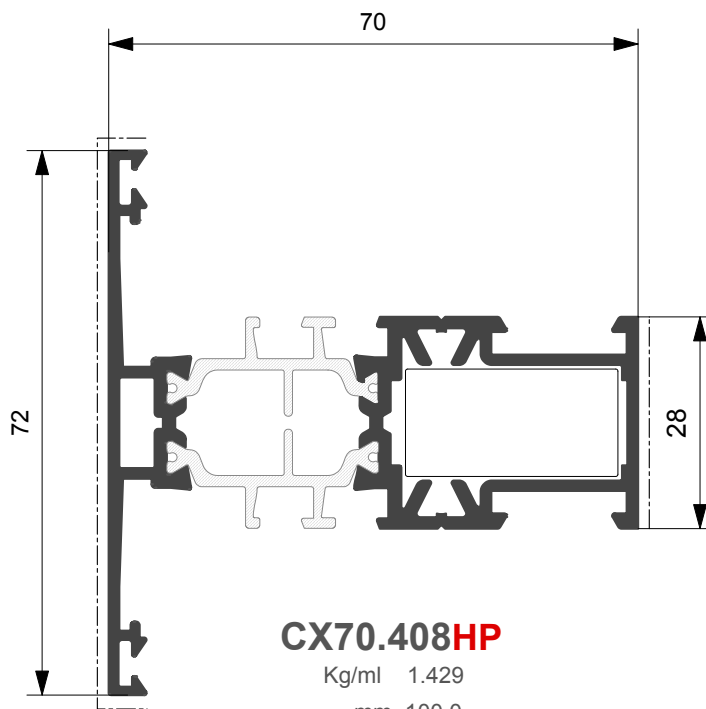

CX70.408HP

Kg/ml 1.429

--- mm. 100,0

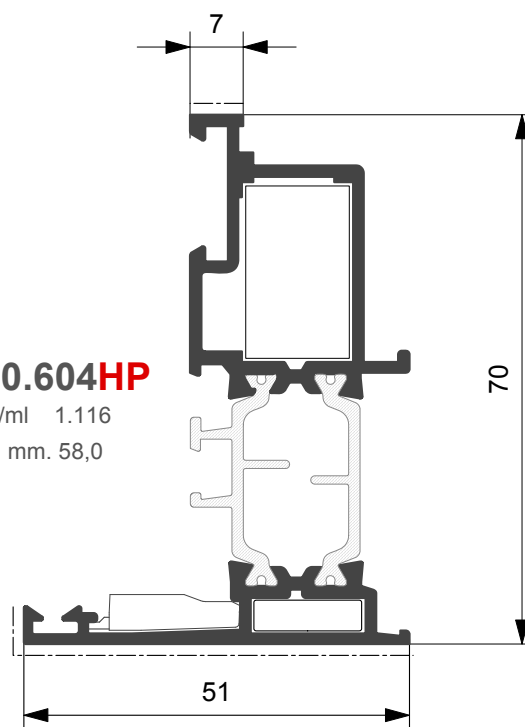

CX70.604HP

Kg/ml 1.116

--- mm. 58,0

Profilato	Squadretta esterna		Squadretta interna			Squadretta allineamento	
	Cianfrinare	Spinare	Bottone	Cianfrinare	Spinare	Esterna	Interna
CX70.303HP	ARX.03.SQ	ARX.03.SQ + ARX.08.SQ	ACX.01.SQ	ACX.02.SQ	ACX.02.SQ + ARX.07.SQ		ARX.10.SQ
CX70.604HP	ARX.03.SQ	ARX.06.SQ + ARX.08.SQ	ARX.13.SQ			ARX.15.SQ	

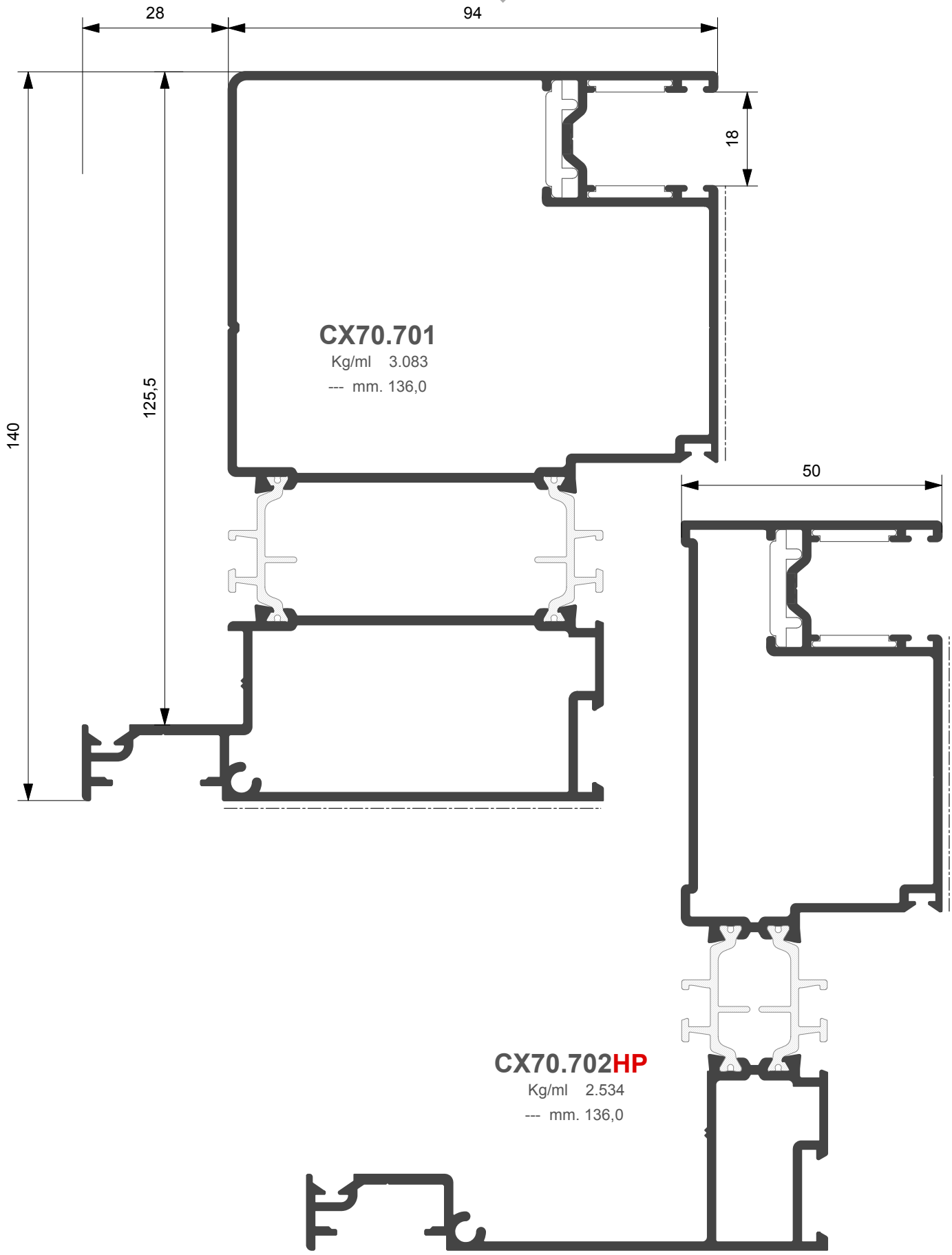

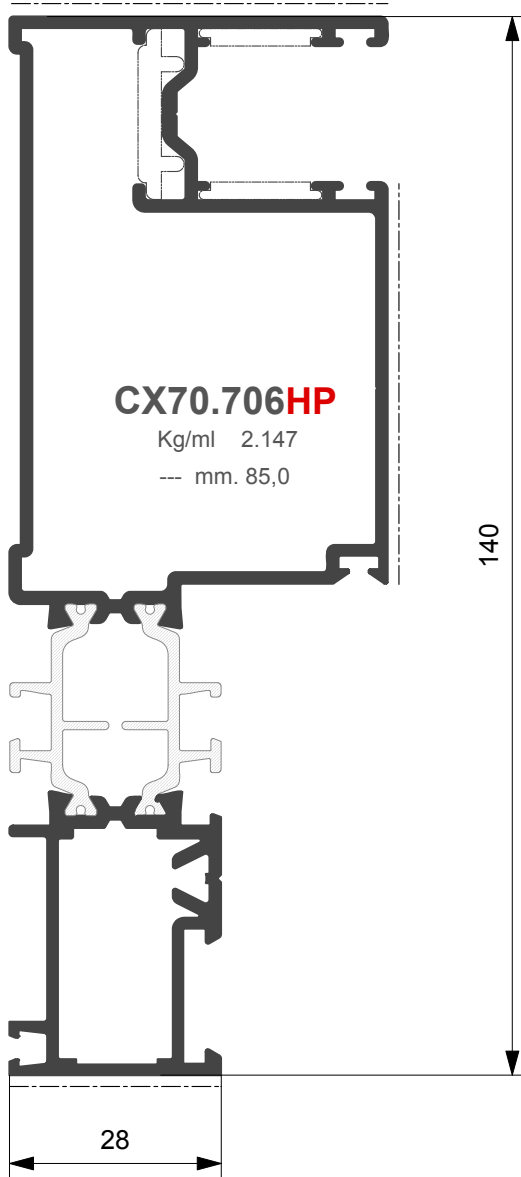

CX70.706HP

Kg/ml 2.147

--- mm. 85,0

140

28



XX70.705

Kg/ml 0.155

--- mm. 000,0

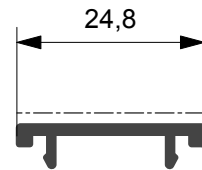

24,8

XX70.704

Kg/ml 0.135

--- mm. 25,0

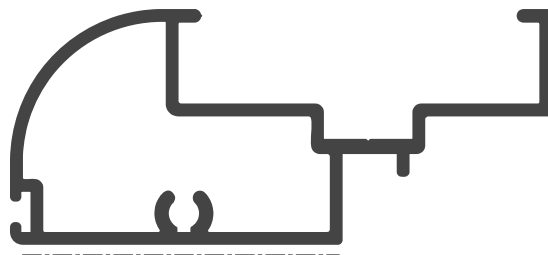

XX70.703

Kg/ml 0.791

--- mm. 43,0

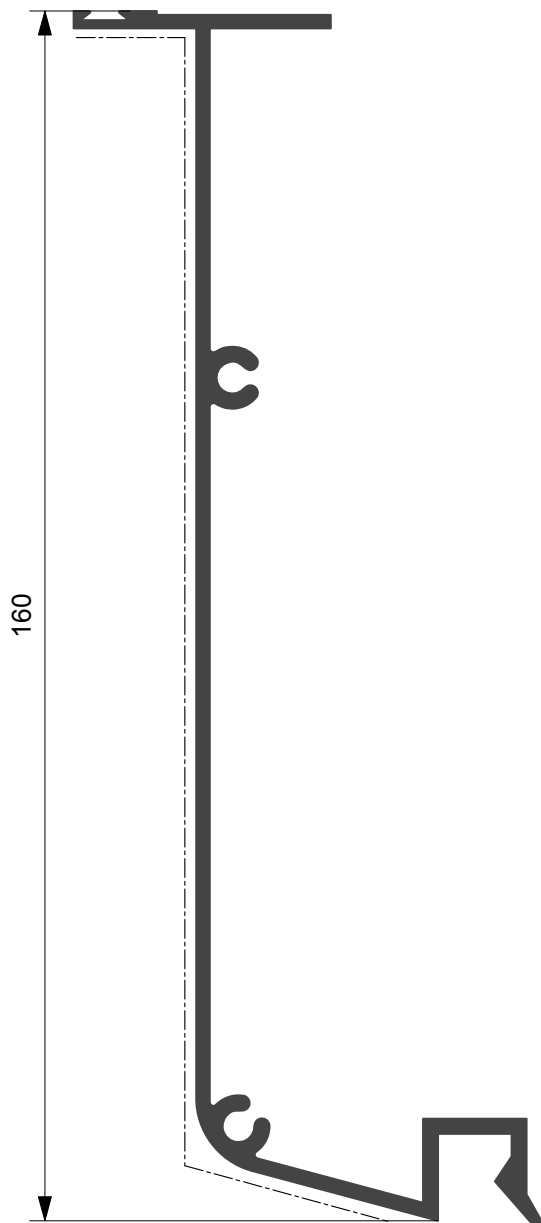

CX45.3363

Kg/ml 1.379
--- mm. 182,0

CX45.3362

Kg/ml 1.150
--- mm. 212,0

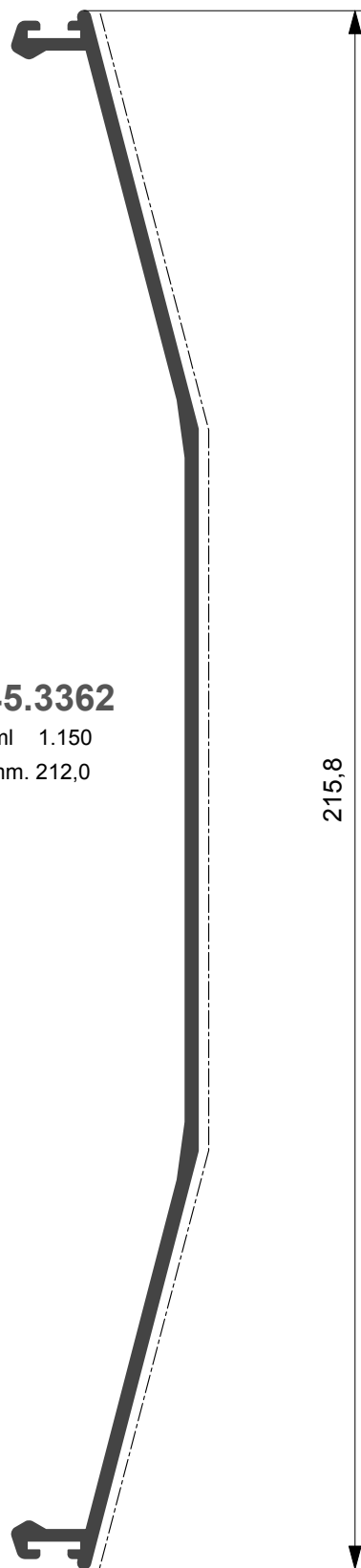

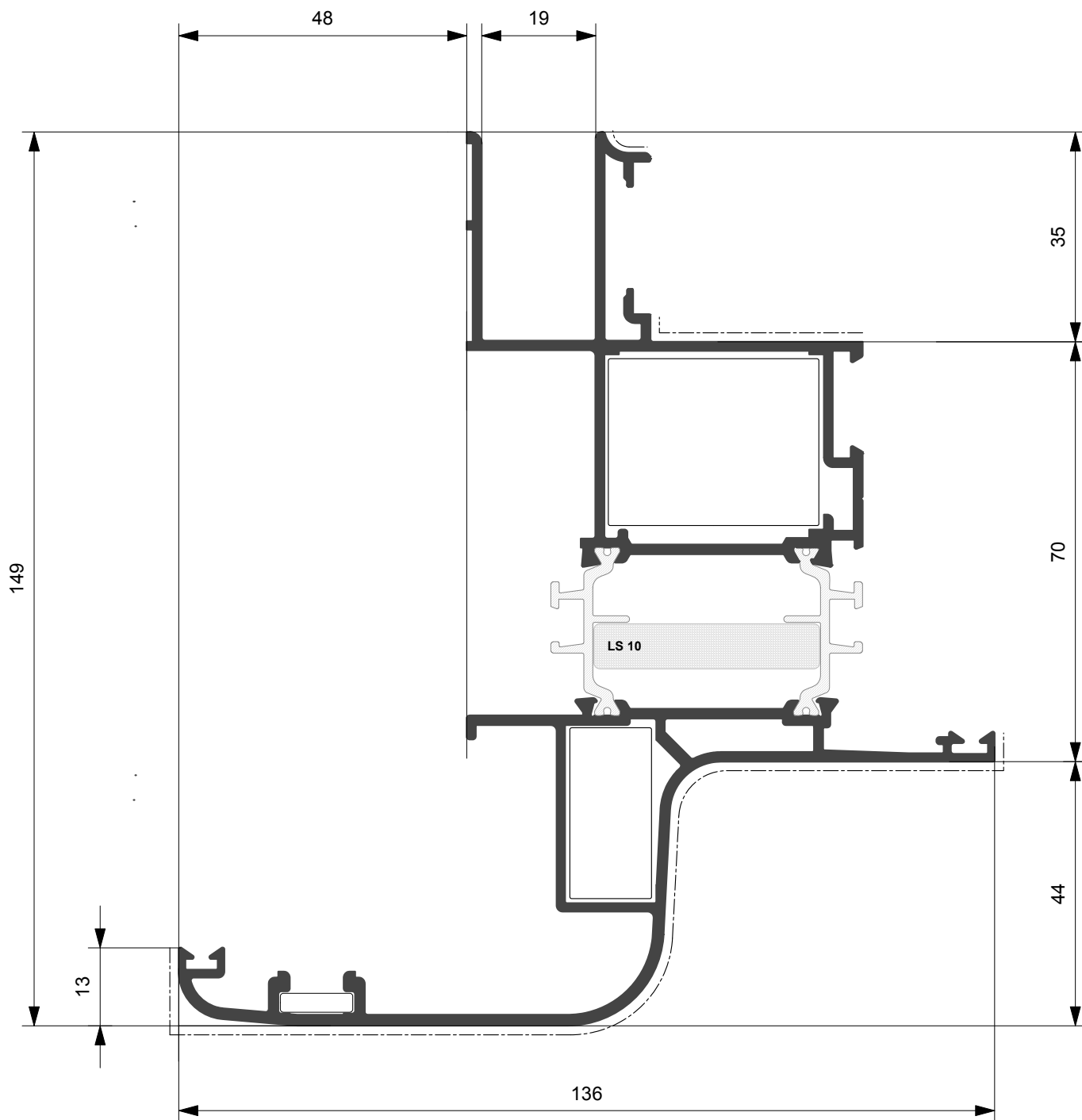

CX70.109HP

Kg/ml 2.969

--- mm. 242,0

Profilato	Squadretta esterna		Squadretta interna			Squadretta allineamento	
	Cianfrinare	Spinare	Bottone	Cianfrinare	Spinare	Esterna	Interna
CX70.109HP	ARX.01.SQ	ARX.02.SQ + ARX.07.SQ	ACX.04.SQ			ARX.15.SQ	ARX.10.SQ

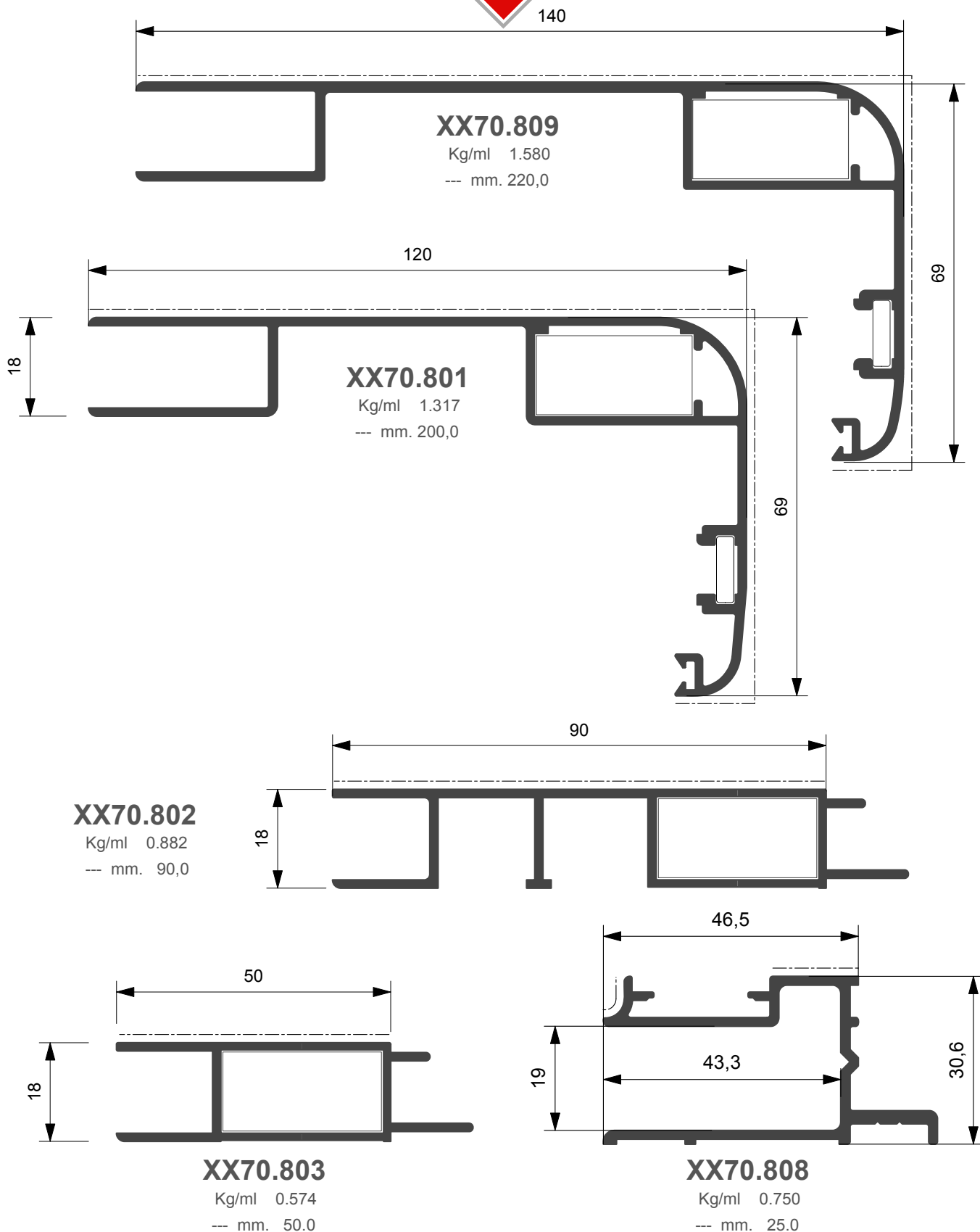

Profilato	Squadretta esterna		Squadretta interna			Squadretta allineamento	
	Bottono	Spinare	Bottono	Cianfrinare	Spinare	Esterna	Interna
XX70.801			ACX.01.SQ	ACX.02.SQ	ACX.02.SQ + ARX.07.SQ		ARX.11.SQ
XX70.802			ACX.01.SQ	ACX.02.SQ	ACX.02.SQ + ARX.07.SQ		
XX70.803			ACX.01.SQ	ACX.02.SQ	ACX.02.SQ + ARX.07.SQ		
XX70.809			ACX.01.SQ	ACX.02.SQ	ACX.02.SQ + ARX.07.SQ		ARX.11.SQ

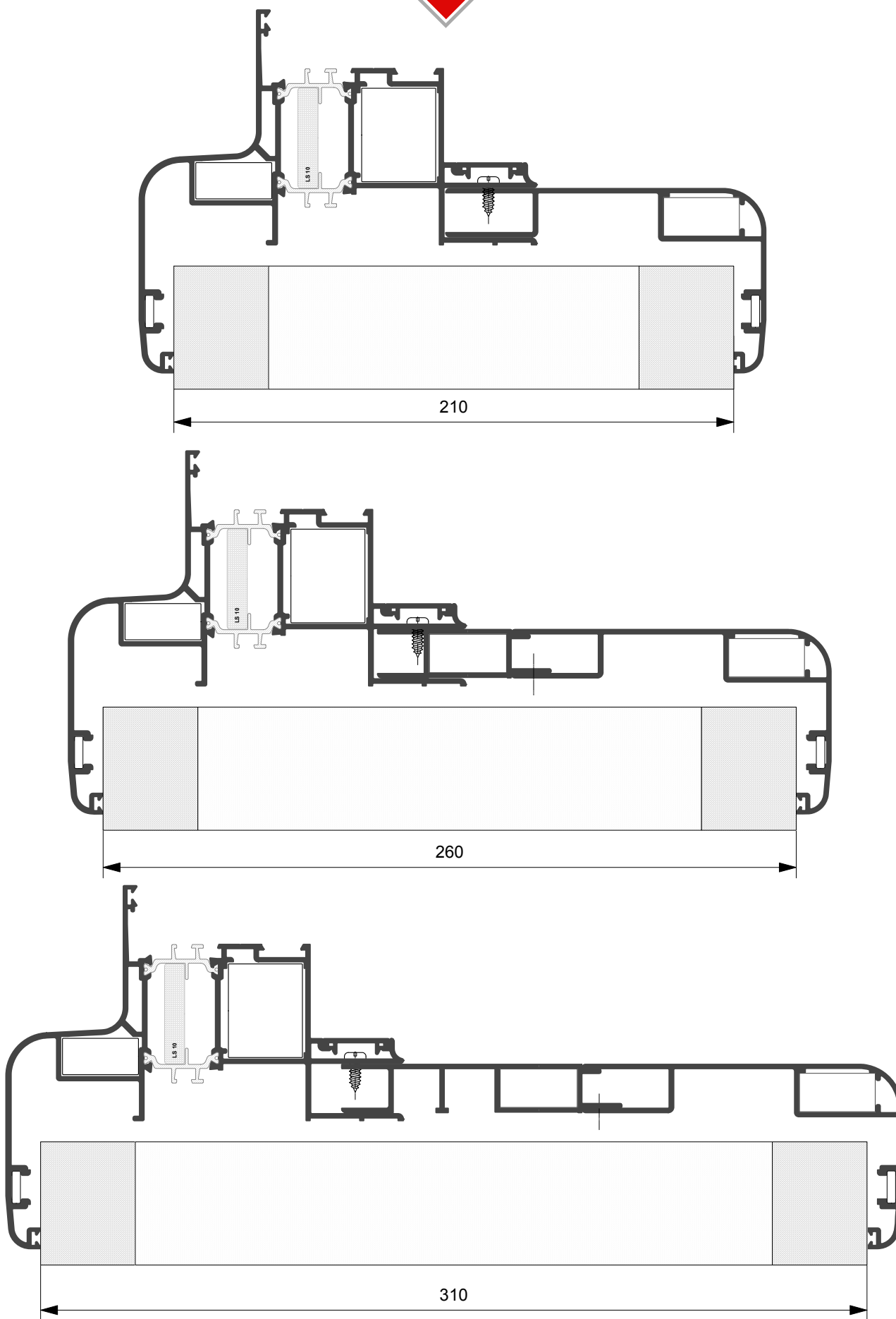



CX70.540

Kg/ml 0.2249
--- mm. 32,0

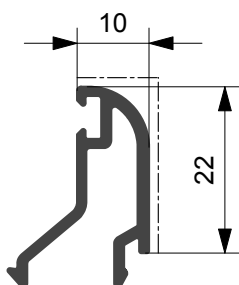

CX70.521

Kg/ml 0.266
--- mm. 36,0

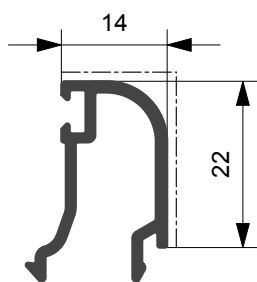

CX70.522

Kg/ml 0.277
--- mm. 40,0

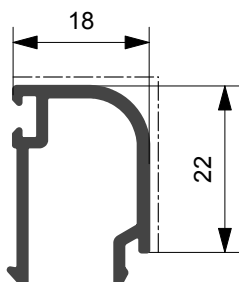

CX70.523

Kg/ml 0.294
--- mm. 44,0

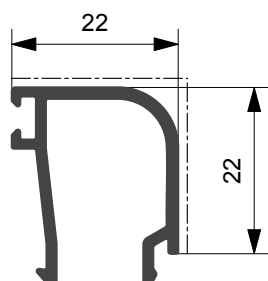

CX70.524

Kg/ml 0.314
--- mm. 48,0

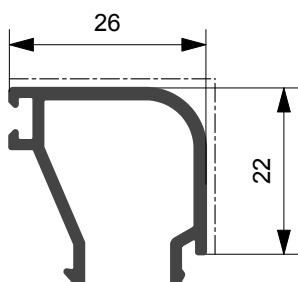

CX70.525

Kg/ml 0.350
--- mm. 52,0

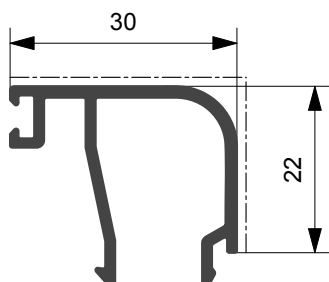

**APPLICAZIONE FERMAVETRI
TONDI**

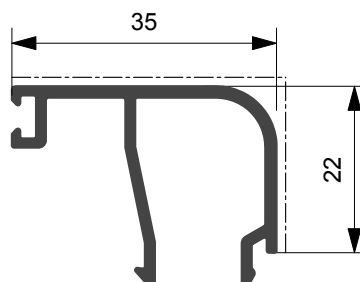
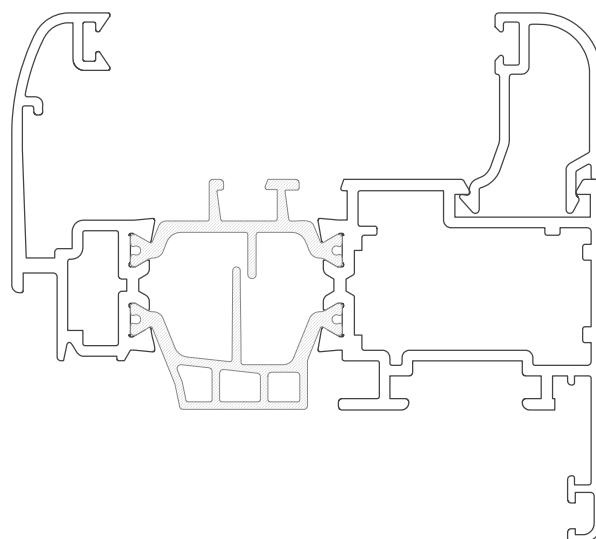

CX70.531

Kg/ml 0.370
--- mm. 57,0



CX70.533

Kg/ml 0.252
--- mm. 27,0

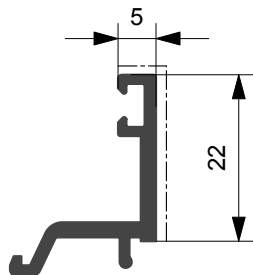

**APPLICAZIONE FERMAVETRI
DRITTI**

CX70.539

Kg/ml 0.245
--- mm. 27,0

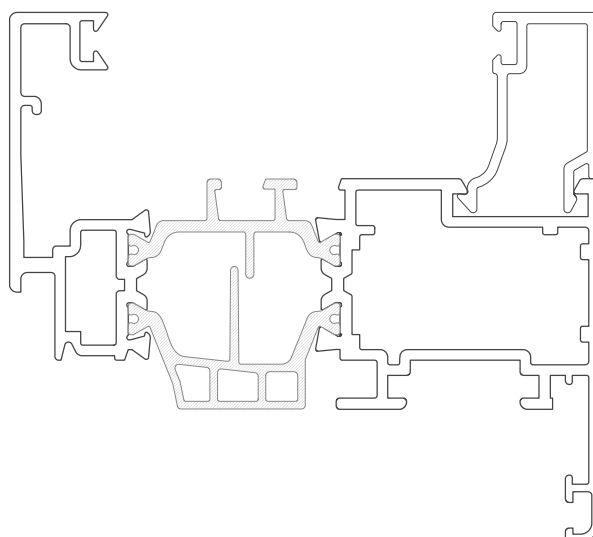
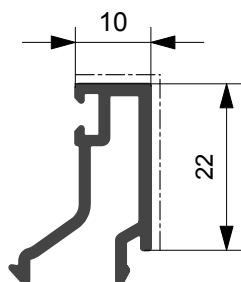

CX70.526

Kg/ml 0.279
--- mm. 36,0

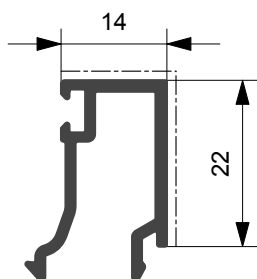

CX70.527

Kg/ml 0.290
--- mm. 40,0

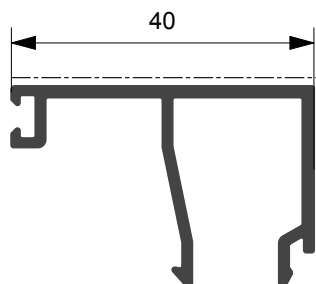
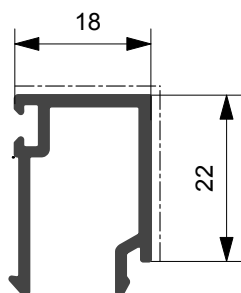

CX70.537

Kg/ml 0.403
--- mm. 62,0

CX70.528

Kg/ml 0.307
--- mm. 44,0

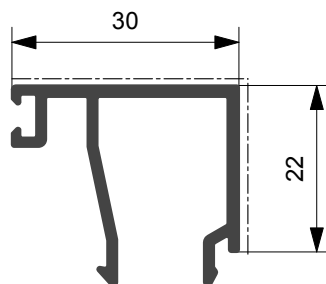
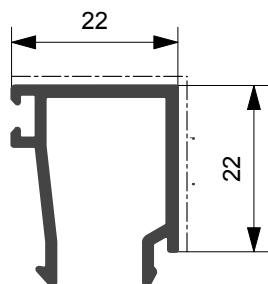

CX70.530

Kg/ml 0.362
--- mm. 52,0

CX70.529

Kg/ml 0.327
--- mm. 48,0

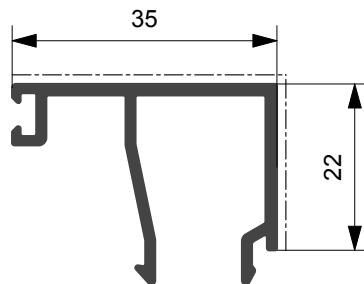
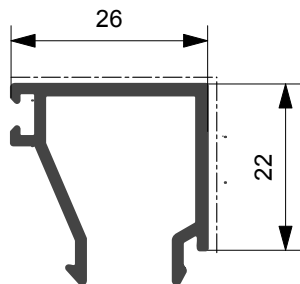

CX70.532

Kg/ml 0.383
--- mm. 57,0



CX70.571

Kg/ml 0.216
--- mm. 36,0

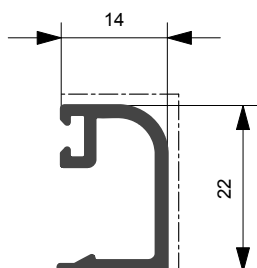

CX70.572

Kg/ml 0.262
--- mm. 40,0

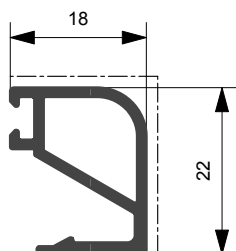

CX70.573

Kg/ml 0.283
--- mm. 44,0

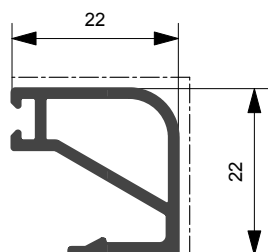

CX70.574

Kg/ml 0.313
--- mm. 48,0

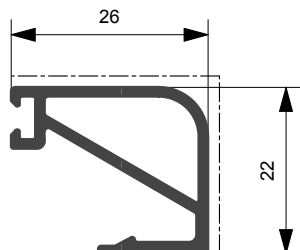

CX70.575

Kg/ml 0.340
--- mm. 52,0

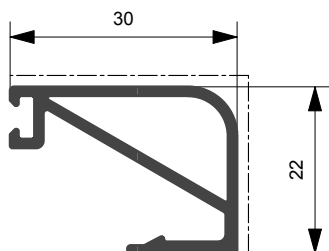

RX70.581

Kg/ml 0.361
--- mm. 57,0

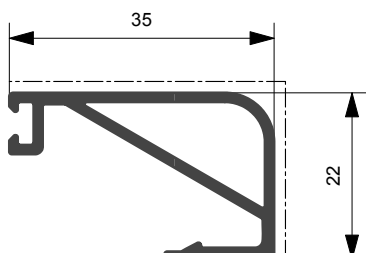

APPLICAZIONE FERMAVETRI CON CLIPS

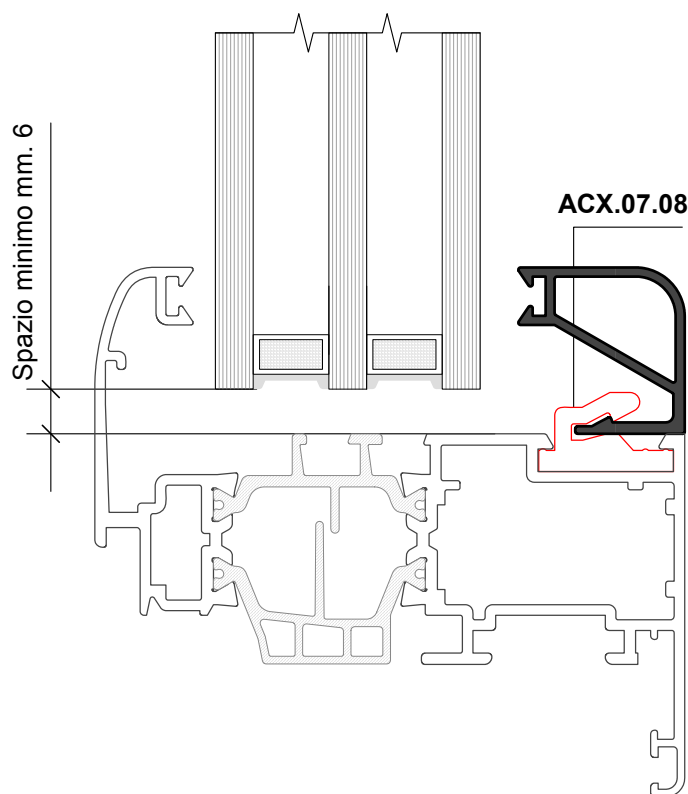

E' consigliabile l'abbinamento con fermavetri tradizionali tondi con taglio a 45° ,al fine di evitare gli angoli fermavetro in zama



CX70.568

Kg/ml 0.297
--- mm. 32,0

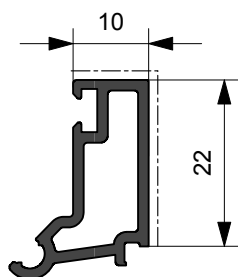

CX70.562

Kg/ml 0.324
--- mm. 36,0

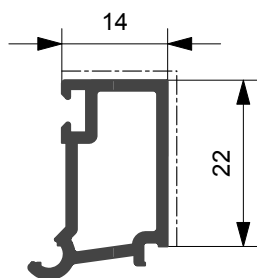

CX70.563

Kg/ml 0.330
--- mm. 40,0

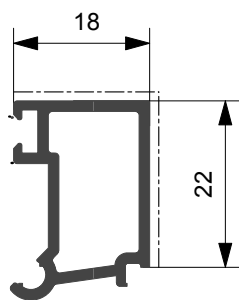

CX70.564

Kg/ml 0.348
--- mm. 44,0

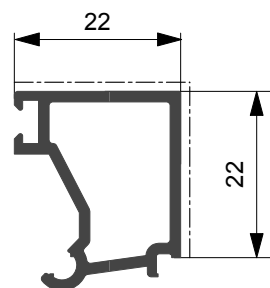

CX70.565

Kg/ml 0.372
--- mm. 48,0

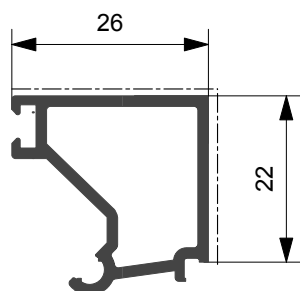

CX70.566

Kg/ml 0.396
--- mm. 52,0

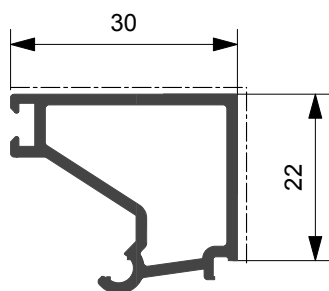

APPLICAZIONE FERMAVETRI DI SICUREZZA

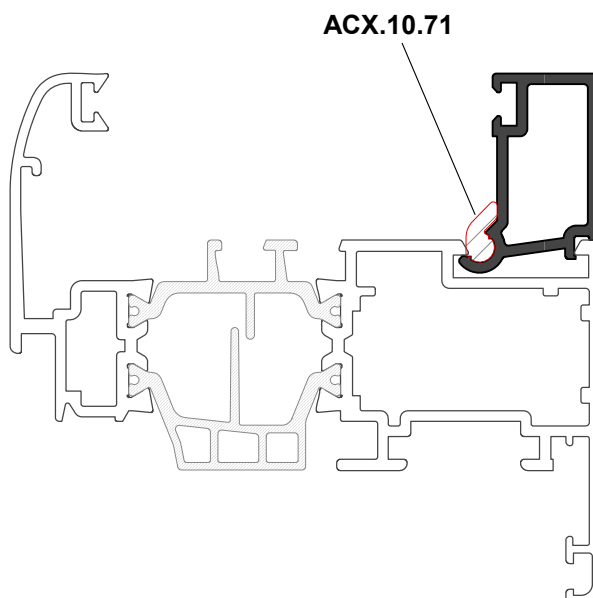

ACX.10.71

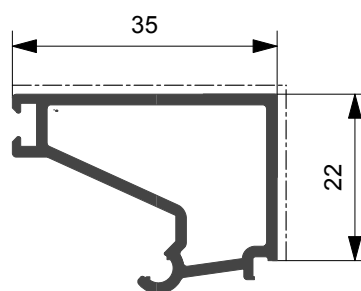

CX70.567

Kg/ml 0.434
--- mm. 57,0

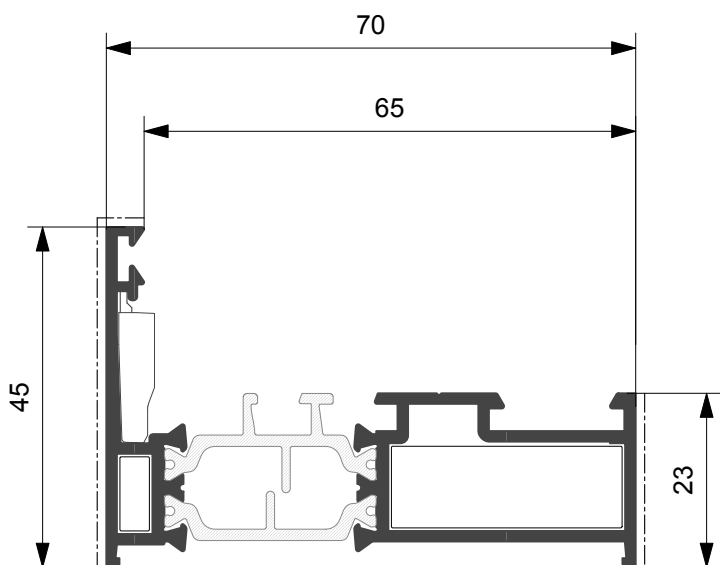

CX70S.101HP

Kg/ml 1,023
--- mm. 73

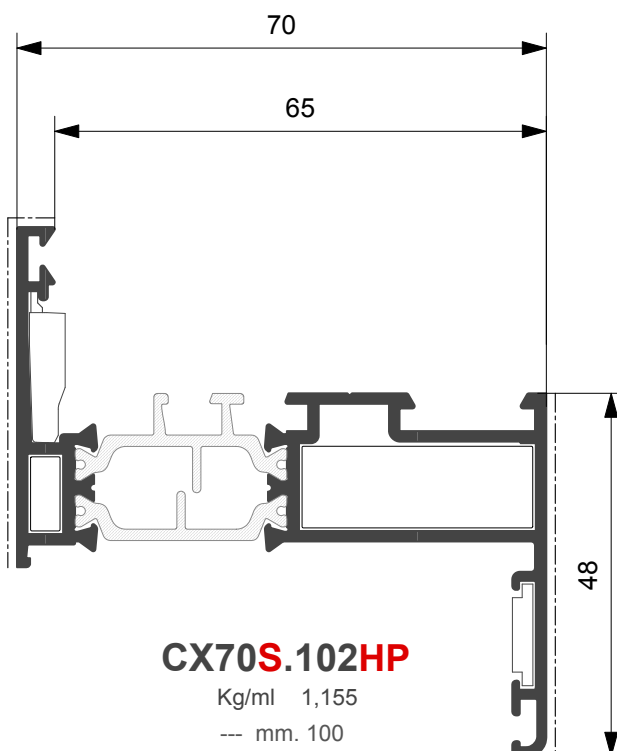

CX70S.102HP

Kg/ml 1,155
--- mm. 100

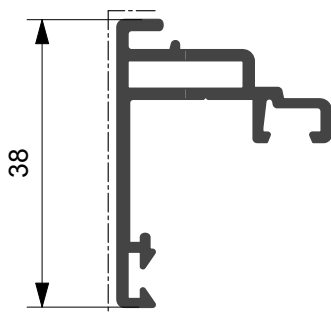

CX60S.304

Kg/ml 0.427
--- mm. 48

NB

Utilizzare barretta **BX 22 R**

Profilato	Squadretta esterna		Squadretta interna			Squadretta allineamento	
	Cianfrinare	Con grano fissaggio	Bottone	Cianfrinare	Spinare	Esterna	Interna
CX70S.101HP	ACX.36.SQ	ACX.36.SQ + GRLM4x5ECP	ACX.35.SQ			ARX.15.SQ	
CX70S.102HP	ACX.36.SQ	ACX.36.SQ + GRLM4x5ECP	ACX.35.SQ			ARX.15.SQ	ARX.10.SQ

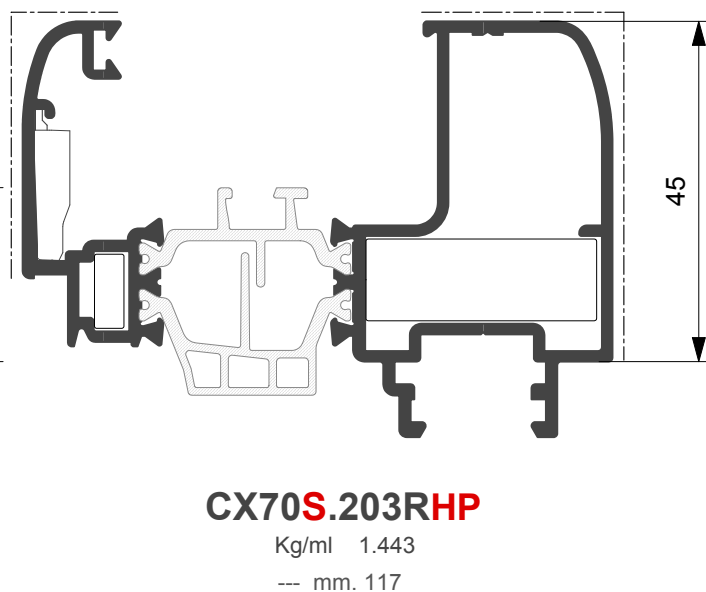
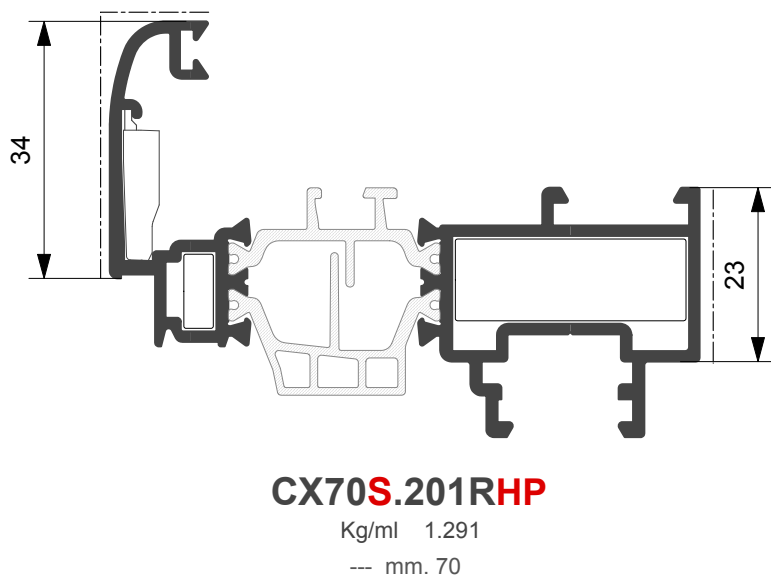
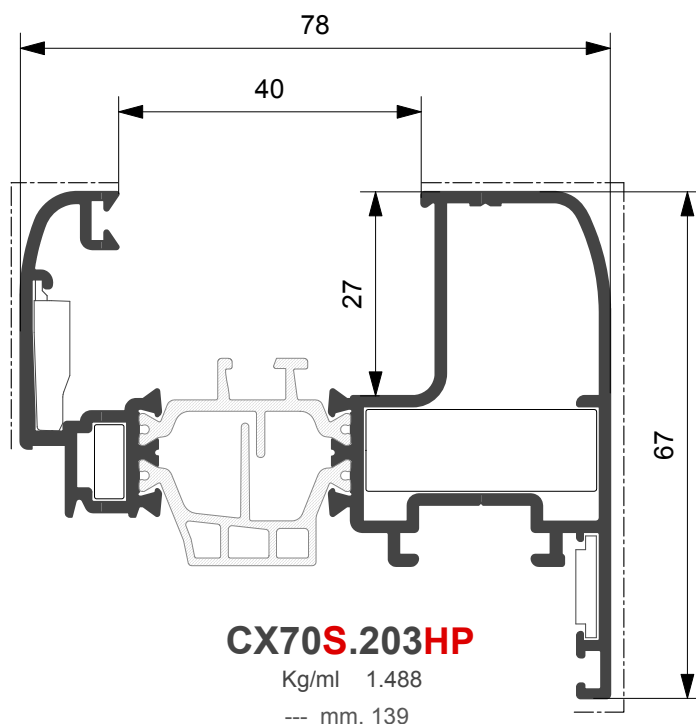
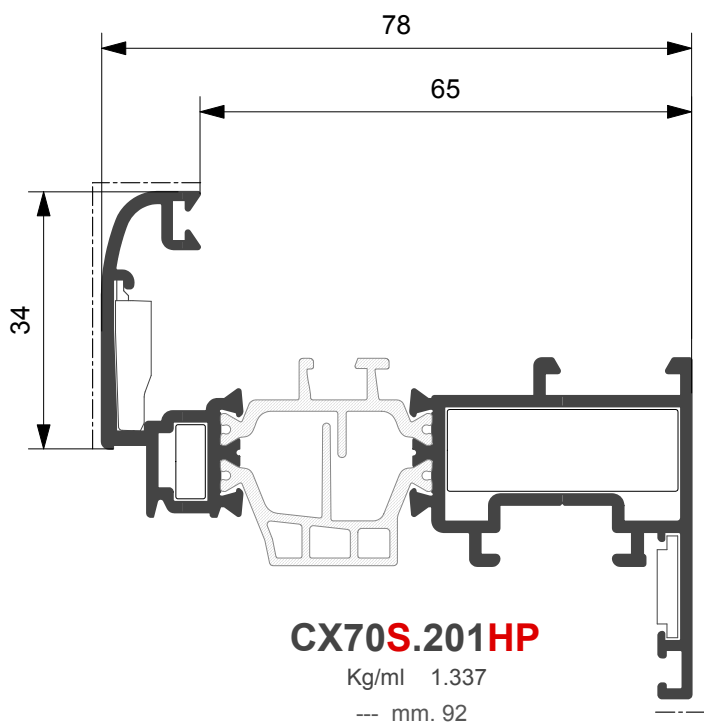

NB

Utilizzare barretta **BX 22 R**

Profilato	Squadretta esterna		Squadretta interna			Squadretta allineamento	
	Cianfrinare	Con grano fissaggio	Bottone	Cianfrinare	Spinare	Esterna	Interna
CX70S.201HP	ACX.36.SQ	ACX.36.SQ + GRLM4x5ECP	ACX.35.SQ			ARX.15.SQ	ARX.10.SQ
CX70S.201RHP	ACX.36.SQ	ACX.36.SQ + GRLM4x5ECP	ACX.35.SQ			ARX.15.SQ	
CX70S.203HP	ACX.36.SQ	ACX.36.SQ + GRLM4x5ECP	ACX.35.SQ			ARX.15.SQ	ARX.10.SQ
CX70S.203RHP	ACX.36.SQ	ACX.36.SQ + GRLM4x5ECP	ACX.35.SQ			ARX.15.SQ	



Aletta (a) mm.	Vuoto (v) mm.	Dimensione fermavetro (f) mm.	Codice Fermavetro D = dritto T = tondo	Guarnizione esterna mm.	Guarnizioni interne vetro							
					ARX.10.15		ARX.10.14		ARX.10.13		ARX.10.12	
					mm.10	mm.9	mm.8	mm.7	mm.6	mm.5	mm.4	mm.3
Vetragezione (spessore vetro in mm.)												
5	30	35	D CX70.532 T CX70.531	3	17	18	19	20	21	22	23	24
5	35	30	D CX70.530 T CX70.525	3	22	23	24	25	26	27	28	29
5	39	26	D CX70.529 T CX70.524	3	26	27	28	29	30	31	32	33
5	43	22	D CX70.528 T CX70.523	3	30	31	32	33	34	35	36	37
5	46	18	D CX70.527 T CX70.522	3	34	35	36	37	38	39	40	41
5	51	14	D CX70.526 T CX70.521	3	38	39	40	41	42	43	44	45
5	60	5	D CX70.533	3	47	48	49	50	51	52	53	54

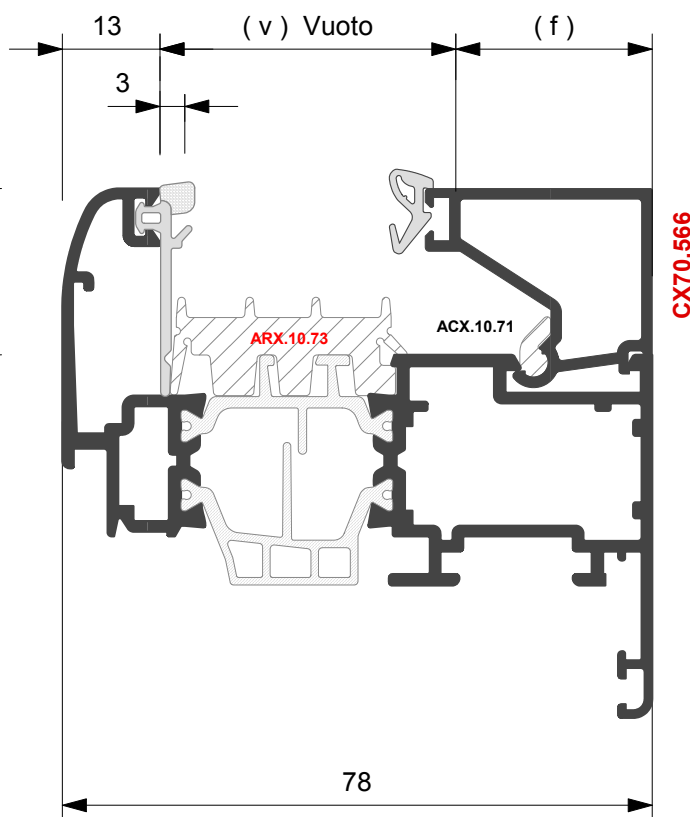
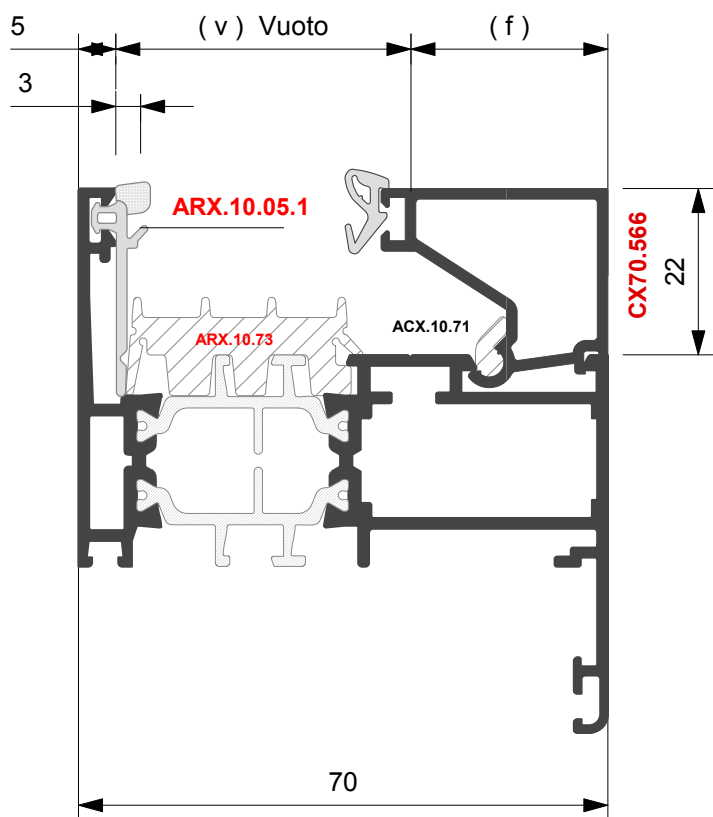



APPLICAZIONE TASSELLI VETRO PER TIPOLOGIA

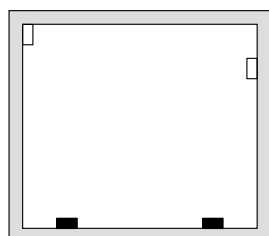

Telaio fisso

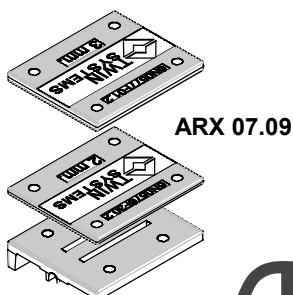

ARX 07.09

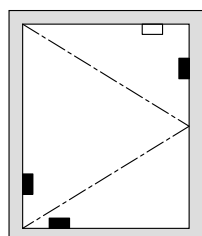
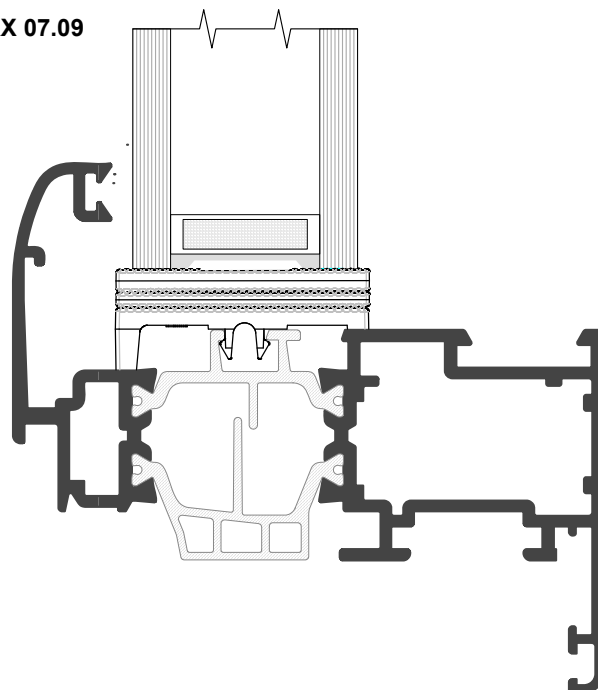

Anta a battente

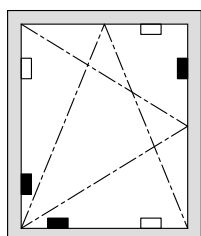

Anta ribalta

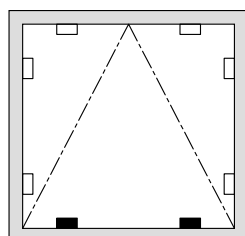

Wasistas

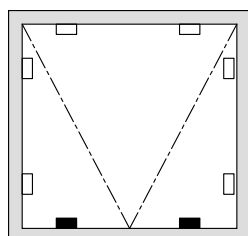

Sporgere

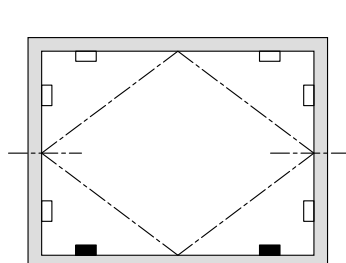

Bilico orizzontale

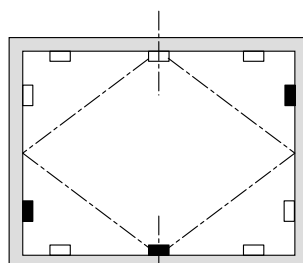

Bilico verticale

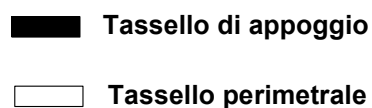

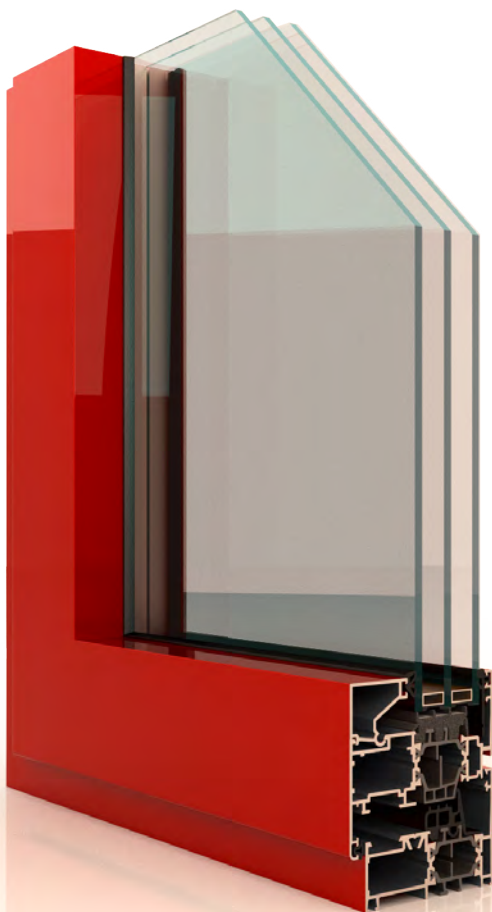

Accessori e
Guarnizioni

Gruppo C



Codifica finiture superficiali accessori



















In fase di ordine aggiungere agli accessori di seguito riportati, ove previste, le seguenti codifiche superficiali :

SIGLA	DESCRIZIONE
NEOPA	VERNICIATO NERO OPACO
R9010	VERNICIATO BIANCO
R1013	VERNICIATO AVORIO
R6005	VERNICIATO VERDE
R9005	VERNICIATO NERO LUCIDO
R8017	VERNICIATO MARRONE
G6360	VERNICIATO VERDE GOTICO
G9420	VERNICIATO GRIGIO GOTICO
G3976	VERNICIATO MARRONE GOTICO
VEARG	VERNICIATO ARGENTO
VSCRA	VERDE SCURO RAGGRINZITO
MARAG	MARRONE RAGGRINZITO
KANFU	CANNA DI FUCILE GOLDFINISH
KRAME	RAME GOLDFINISH
KINOX	INOX LUCIDO GOLDFINISH
KSATI	INOX SATINATO GOLDFINISH
KGOLD	GOLD GOLDFINISH
KANTIC	OTTONE ANTICO GOLDFINISH
ARGENT	NEW ARGENTO
BRONZ	NEW BRONZO

Esempio :

ACX.02.01 - R9010 Cerniera verniciata bianco Ral 9010



<p>ACX.01.SQ</p> <p>Descrizione Squadretta a pulsante (28.5 mm x 14.5 mm)</p>		<p>ACX.12.SQ</p> <p>Descrizione Cavallotto (28.5 mm x 14.5 mm)</p>	
<p>ACX.02.SQ</p> <p>Descrizione Squad. cianfrinare/spinare/avvit. (28.5 mm x 14.5 mm)</p>		<p>ARX.13.SQ</p> <p>Descrizione Squadretta a pulsante (23.5 mm x 14.5 mm)</p>	
<p>ARX.03.SQ</p> <p>Descrizione Squadretta cianfrinare/spinare (4.3 mm x 14 mm)</p>		<p>ACX.14.SQ</p> <p>Descrizione Squad. cianfrinare/spinare/avvit. (28.5 mm x 35.8 mm)</p>	
<p>ACX.04.SQ</p> <p>Descrizione Squadretta a pulsante (28.5 mm x 35.8 mm)</p>		<p>ARX.15.SQ</p> <p>Descrizione Squadretta allineamento esterna tiraggio meccanico</p>	
<p>ACX.05.SQ</p> <p>Descrizione Squadretta angolo variabile (28.5 mm x 14.5 mm)</p>	 <p style="text-align: right;">dx - sx</p>	<p>ARX.18.SQ</p> <p>Descrizione Squadretta cianfrinare/spinare (4.3 mm x 26.3 mm)</p>	
<p>ARX.06.SQ</p> <p>Descrizione Squadretta cianfrinare/spinare (4.3 mm x 39.1 mm)</p>		<p>ARX.24.SQ</p> <p>Descrizione Squad. allineamento esterna</p>	
<p>ARX.07.SQ</p> <p>Spina per ACX.02.SQ e ACX.14.SQ</p>		<p>ACX.29.SQ</p> <p>Descrizione Cavallotto e vite (Prof. CX70.402)</p>	
<p>ARX.08.SQ</p> <p>Spina per ACX.03.SQ e ACX.06.SQ</p>			
<p>ARX.10.SQ</p> <p>Descrizione Squadretta allineamento interna</p>		<p>ARX.34.SQ</p> <p>Descrizione Squadretta per profilo scuretto RX450.427</p>	
<p>ARX.11.SQ</p> <p>Descrizione Squadretta allineamento interna su profilo XX70.801 e RX60.109</p>		<p>ASX.24.SQ</p> <p>Descrizione Squadretta a pulsante (31.8 mm x 10.4 mm)</p>	



Cerniere

<p>ACX.35.SQ</p> <p>Descrizione</p> <p>Squadretta a pulsante</p>	 <p>SLIM</p>	<p>ACX.02.08</p> <p>Descrizione</p> <p>Braccio corto per vasistas (anta da mm. 280 a mm. 800)</p>	
<p>ACX.36.SQ</p> <p>Descrizione</p> <p>Squadretta est. cianfrinare o con grano GRLM4x5ECP da ordinare a parte</p>	 <p>SLIM</p>	<p>ACX.02.09</p> <p>Descrizione</p> <p>Braccio telescopico per vasistas a scatto</p>	
<p>ACX.02.01</p> <p>Descrizione</p> <p>Cerniera a montaggio rapido preassemblata a 2 ali</p>		<p>ACX.02.10</p> <p>Descrizione</p> <p>Cerniera a compasso</p>	
<p>ACX.02.02</p> <p>Descrizione</p> <p>Cerniera a montaggio rapido preassemblata a 2 ali per 3°anta</p>		<p>ACX.02.10P</p> <p>Descrizione</p> <p>Cerniera cerniera scomparsa battente 40 kg, sporgere 120 kg, vasistat 120 kg</p>	
<p>ACX.02.03</p> <p>Descrizione</p> <p>Cerniera a montaggio rapido preassemblata a 3 ali</p>		<p>ACX.02.11</p> <p>Descrizione</p> <p>Cerniera a 2 ali per porte con piastrina ad infilare</p>	
<p>ACX.02.04</p> <p>Descrizione</p> <p>Cerniera a montaggio rapido preassemblata a 3 ali per 3°anta</p>		<p>ARX.02.12</p> <p>Descrizione</p> <p>Cerniera per porte esterna a 2 ali interasse 67 mm.</p>	
<p>ACX.02.05</p> <p>Descrizione</p> <p>Cerniera per vasistas apertura singola 30°</p>		<p>ARX.02.13</p> <p>Descrizione</p> <p>Cerniera per porte esterna a 3 ali interasse 67 mm.</p>	
<p>ACX.02.06</p> <p>Descrizione</p> <p>Cerniera per vasistas apertura doppia 30°/75°</p>		<p>ARX.02.14</p> <p>Descrizione</p> <p>Cerniera per porte esterna a 2 ali interasse 93 mm.</p>	
<p>ACX.02.07</p> <p>Descrizione</p> <p>Braccio lungo per vasistas (anta da mm. 600 a mm. 1600)</p>		<p>ARX.02.15</p> <p>Descrizione</p> <p>Cerniera per porte esterna a 3 ali interasse 93 mm.</p>	



<p>ARX.02.16</p> <p>Descrizione</p> <p>Spessore mm.8 per cerniere esterne per porte</p>		<p>ACX.02.41</p> <p>Descrizione</p> <p>Cerniera montaggio rapido "TOP RAPID"</p>	 <p>SLIM</p>
<p>ARX.02.17</p> <p>Descrizione</p> <p>Cerniera per scuretto</p>		<p>ACX.03.01</p> <p>Descrizione</p> <p>Cricchetto in alluminio fissaggio con piastrine</p>	
<p>ARX.02.21</p> <p>Descrizione</p> <p>Kit contropiastre cerniere a 2 ali</p>		<p>ARX.03.02</p> <p>Descrizione</p> <p>Maniglia a tavellino</p>	
<p>ARX.02.22</p> <p>Descrizione</p> <p>Kit contropiastre cerniere a 3 ali</p>		<p>ARX.03.03</p> <p>Descrizione</p> <p>Maniglia doppia</p>	
<p>ARX.02.23</p> <p>Descrizione</p> <p>Perni fissaggio cerniere da 68 mm.</p>		<p>ASX.03.03</p> <p>Descrizione</p> <p>Martellina doppia COMFORT</p>	
<p>ARX.02.24</p> <p>Descrizione</p> <p>Viti di fissaggio cerniere</p>		<p>ARX.03.04</p> <p>Descrizione</p> <p>Martellina Sporgenza quadro mm.24</p>	
<p>ARX.02.25</p> <p>Descrizione</p> <p>Kit gradino</p>		<p>ARX.03.05</p> <p>Descrizione</p> <p>Martellina con chiave Sporgenza quadro mm.24</p>	
<p>ARX.02.37</p> <p>Descrizione</p> <p>Regolatore in altezza per cerniere ARX.02.11</p>		<p>ARX.03.05LDX</p> <p>Descrizione</p> <p>Martellina LOGICA dx Sporgenza quadro mm.24</p>	
<p>ACX.02.40</p> <p>Descrizione</p> <p>Cerniera montaggio rapido "TOP RAPID"</p>	 <p>SLIM</p>	<p>ARX.03.05LSX</p> <p>Descrizione</p> <p>Martellina LOGICA sx Sporgenza quadro mm.24</p>	



















<p>ARX.03.06</p> <p>Descrizione</p> <p>Cremonese Interasse 84 - 92 - 104</p>		<p>ACX.03.14</p> <p>Descrizione</p> <p>Incontro asta doppio</p>	
<p>ARX.03.07</p> <p>Descrizione</p> <p>Cremonese con chiave Interasse 84 - 92 - 104</p>		<p>ACX.03.15</p> <p>Descrizione</p> <p>Ferma anta</p>	
<p>ARX.03.07LDX</p> <p>Descrizione</p> <p>Cremonese LOGICA dx Interasse 84 - 92 - 104</p>		<p>ACX.03.16</p> <p>Descrizione</p> <p>Perno di chiusura supplementare regolabile</p>	
<p>ARX.03.07LSX</p> <p>Descrizione</p> <p>Cremonese LOGICA sx Interasse 84 - 92 - 104</p>		<p>ACX.03.17</p> <p>Descrizione</p> <p>Innesti cremonese</p>	
<p>ARX.03.08</p> <p>Descrizione</p> <p>Cremonese per Anta Ribalta</p>		<p>ACX.03.18</p> <p>Descrizione</p> <p>Terminali astina</p>	
<p>ARX.03.09</p> <p>Descrizione</p> <p>Movimentazione Bidirezionale Interasse da 15-27 mm.</p>		<p>ACX.03.19</p> <p>Descrizione</p> <p>Sostegno anta</p>	
<p>ACX.03.10</p> <p>Descrizione</p> <p>Movimentazione Unidirezionale per Anta Ribalta</p>		<p>ARX.03.22</p> <p>Descrizione</p> <p>Fast Out chiusura apert. esterna L=1000 mm.(3 punti) E = 35mm.</p>	
<p>ACX.03.11</p> <p>Descrizione</p> <p>Catenacciolo a leva</p>		<p>ARX.03.23</p> <p>Descrizione</p> <p>Fast Out chiusura apert. esterna L=600 mm.(2 punti) E = 35mm.</p>	
<p>ACX.03.12</p> <p>Descrizione</p> <p>Terminale asta</p>		<p>ARX.03.24</p> <p>Descrizione</p> <p>Fast Out chiusura apert. esterna L=1600 mm.(3 punti) E = 35mm.</p>	





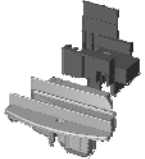

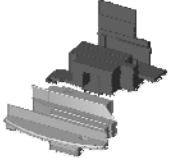





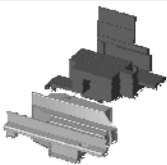

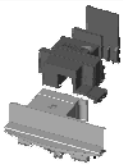





<p>ACX.03.25</p> <p>Descrizione</p> <p>Kit Fast Out chiusura apert. esterna art. ARX.03.22</p>		<p>ARX.03.48</p> <p>Descrizione</p> <p>Cremonese apertura esterna con chiave</p>	
<p>ACX.03.26</p> <p>Descrizione</p> <p>Kit Fast Out chiusura apert. esterna art. ACX.03.23</p>		<p>ARX.03.50</p> <p>Descrizione</p> <p>Cremonese apertura esterna con chiave</p>	
<p>ACX.03.27</p> <p>Descrizione</p> <p>Kit Fast Out chiusura apert. esterna art. ACX.03.24</p>		<p>ACX.03.52</p> <p>Descrizione</p> <p>Braccio chiusura antieffrazione</p>	
<p>ARX.03.28</p> <p>Descrizione</p> <p>Martellina Sporgenza quadro mm.64 per Fast Out</p>		<p>ACX.03.53</p> <p>Descrizione</p> <p>Martellina Italia Sporgenza quadro 24 mm, con scatto per microventilazione</p>	
<p>ACX.03.29</p> <p>Descrizione</p> <p>Rostro chiusura supplementare</p>		<p>ACX.03.54</p> <p>Descrizione</p> <p>Sirio terminale asta con puntale in ottone ø 6 mm, decentrato dx</p>	
<p>ARX.03.30</p> <p>Descrizione</p> <p>Tavellino per profilo scuretto RX450.427</p>		<p>ACX.03.55</p> <p>Descrizione</p> <p>Sirio terminale asta con puntale in ottone ø 6 mm, decentrato sx</p>	
<p>ACX.03.43</p> <p>Descrizione</p> <p>Astina in poliammide</p>		<p>ACX.03.56</p> <p>Descrizione</p> <p>Sirio terminale asta con puntale in ottone ø 8 mm</p>	
<p>ARX.03.45</p> <p>Descrizione</p> <p>Perno trascinamento L=22 mm.</p>		<p>ACX.03.57</p> <p>Descrizione</p> <p>Cremonese ITALIA int. 84,5 - 104 mm.</p>	
<p>ARX.03.46</p> <p>Descrizione</p> <p>Cremonese con chiave</p>		<p>ACX.03.58</p> <p>Descrizione</p> <p>Kit base accessori per chiusura antieffrazione</p>	



<p>ACX.03.59</p> <p>Descrizione Cremonese ITALIA per AR con anti falsa manovra su cremonese</p>		<p>ACX.03.68</p> <p>Descrizione Doppia maniglia "Comfort mini"</p>	
<p>ACX.03.60</p> <p>Descrizione Punto chiusura antieffrazione lavorazione astina tonda diam. 8</p>		<p>ACX.03.69</p> <p>Descrizione Doppia maniglia "ITALIA"</p>	
<p>ACX.03.61</p> <p>Descrizione Chiusura antieffrazione sistema di sicurezza per connessione astina</p>		<p>ACX.03.70</p> <p>Descrizione Catenaccio a comando diretto Sirio</p>	
<p>ACX.03.62</p> <p>Descrizione Incontro a pozzetto per puntale \varnothing 6 mm</p>		<p>ACX.03.71</p> <p>Descrizione Catenaccio a leva "Mini tex"</p>	 <p style="text-align: right;">SLIM</p>
<p>ACX.03.63</p> <p>Descrizione Incontro a pozzetto per puntale \varnothing 6 mm</p>		<p>ACX.03.72</p> <p>Descrizione Movimentazione Bidirezionale Interasse da 23-35 mm.</p>	
<p>ACX.03.64</p> <p>Descrizione Corpo di manovra a leva "Mini tex"</p>		<p>ACX.03.73</p> <p>Descrizione "COMFORT MINI" Martellina ridotta Sporgenza quadro mm.70</p>	
<p>ACX.03.65</p> <p>Descrizione Catenaccio a leva bidirezionale "bi-hid" kit</p>		<p>ACX.03.74</p> <p>Descrizione "COMFORT MINI" Martellina ridotta con cilindro Sporgenza quadro mm.70</p>	
<p>ACX.03.66</p> <p>Descrizione Perno di trascinamento L=11 mm</p>		<p>ACX.04.01HP</p> <p>Descrizione Tappo riporto Giunto Aperto Profilo riporto tondo</p>	
<p>ACX.03.67</p> <p>Descrizione Perno di trascinamento L=27 mm</p>		<p>ARX.04.02HP</p> <p>Descrizione Tappo riporto G. A. ferr. nastro Profilo riporto tondo</p>	



<p>ACX.04.03HP</p> <p>Descrizione</p> <p>Tappo riporto Giunto Aperto Profilo riporto dritto</p>		<p>ARX.06.02</p> <p>Descrizione</p> <p>Piastrina Registro Universale</p>	
<p>ARX.04.04HP</p> <p>Descrizione</p> <p>Tappo riporto G. A. ferr. nastro Profilo riporto dritto</p>		<p>ARX.06.03</p> <p>Descrizione</p> <p>Grano per registro ARX.06.02</p>	
<p>ACX.04.07</p> <p>Descrizione</p> <p>Tappo doppia battuta</p>		<p>ACX.06.04</p> <p>Descrizione</p> <p>Registro Z/P</p>	
<p>ACX.04.34</p> <p>Descrizione</p> <p>Tappo riporto T - Z</p>	 <p>SLIM</p>	<p>ARX.06.08</p> <p>Descrizione</p> <p>Regolo mobile da mm.15</p>	
<p>ARX.04.20</p> <p>Descrizione</p> <p>Giunto taglio a 90° vetro infilare</p>		<p>ARX.06.09</p> <p>Descrizione</p> <p>Regolo mobile da mm. 20</p>	
<p>ARX.04.30</p> <p>Descrizione</p> <p>Tappo a L battuta inferiore porte</p>		<p>ARX.06.10</p> <p>Descrizione</p> <p>Regolo mobile da mm. 30</p>	
<p>ARX.04.31</p> <p>Descrizione</p> <p>Tappo diritto battuta inf. porte</p>		<p>ARX.06.11</p> <p>Descrizione</p> <p>Regolo mobile da mm. 45</p>	
<p>ARX.05.01</p> <p>Descrizione</p> <p>Cappetta drenaggio acqua</p>		<p>ACX.07.02</p> <p>Descrizione</p> <p>Angolo Universale fermavetro</p>	
<p>ARX.06.01</p> <p>Descrizione</p> <p>Registro Universale</p>		<p>ACX.07.08</p> <p>Descrizione</p> <p>Clip per fermavetri tondi</p>	











<p>ACX.08.01</p> <p>Descrizione</p> <p>Anta Ribalta WEEN Kit base con anti falsa manovra sulla cremonese portata 160 Kg.</p>		<p>ACX.08.16</p> <p>Descrizione</p> <p>Perno chiusura supplementare</p>	
<p>ARX.08.01L</p> <p>Descrizione</p> <p>Anta Ribalta WEEN Kit base con anti falsa manovra sulla cremonese portata 160 Kg.</p> <p>Logica</p>		<p>ACX.08.18</p> <p>Descrizione</p> <p>Chiusura supplementare inferiore orizzontale</p>	
<p>ACX.08.05</p> <p>Descrizione</p> <p>A. R. Braccio Supplementare</p>		<p>ACX.08.19</p> <p>Descrizione</p> <p>Dispositivo microventilazione regolabile</p>	
<p>ACX.08.05L</p> <p>Descrizione</p> <p>A. R. Braccio Supplementare</p> <p>Logica</p>		<p>ACX.08.22</p> <p>Descrizione</p> <p>Anta Ribalta Braccio Corto da 395 mm. a 450 mm.</p>	
<p>ACX.08.06</p> <p>Descrizione</p> <p>Chiusura Supplementare verticale e universale</p>		<p>ACX.08.22L</p> <p>Descrizione</p> <p>Anta Ribalta Braccio Corto da 395 mm. a 450 mm.</p> <p>Logica</p>	
<p>ACX.08.09</p> <p>Descrizione</p> <p>A. R. Cerniere a pettine 2.0</p>		<p>ACX.08.23</p> <p>Descrizione</p> <p>Anta Ribalta Braccio Medio da 451 mm. a 650 mm.</p>	
<p>ACX.08.13</p> <p>Descrizione</p> <p>Incontro asta singolo</p>		<p>ACX.08.23L</p> <p>Descrizione</p> <p>Anta Ribalta Braccio Medio da 451 mm. a 650 mm.</p> <p>Logica</p>	
<p>ACX.08.09</p> <p>Descrizione</p> <p>A. R. Cerniere a pettine 2.0</p>		<p>ACX.08.24</p> <p>Descrizione</p> <p>Anta Ribalta Braccio Lungo da 651 mm. a 1700 mm.</p>	
<p>ACX.08.13</p> <p>Descrizione</p> <p>Incontro asta singolo</p>		<p>ACX.08.24L</p> <p>Descrizione</p> <p>Anta Ribalta Braccio Lungo da 651 mm. a 1700 mm.</p> <p>Logica</p>	













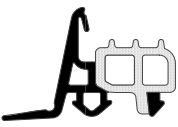

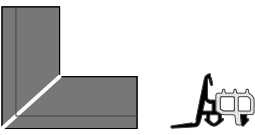

<p>ACX.08.25</p> <p>Descrizione Kit cerniera a pettine regol. Portata 120 Kg.</p>		<p>ACX.08.34</p> <p>Descrizione Ween hide 180 braccio medio AR scomparsa - sx solo per ante CX70.260HP e CX70.261HP</p>	<p>Logica</p>
<p>ACX.08.26</p> <p>Descrizione Cerniere vasistas a scomparsa solo per ante CX70.260HP e CX70.261HP</p>		<p>ACX.08.35</p> <p>Descrizione Ween hide 180 supporto anta per portata 170 kg. ante CX70.260HP e CX70.261HP</p>	
<p>ACX.08.27</p> <p>Descrizione Ween hide 180 braccio corto AR a scomparsa - dx solo per ante CX70.260HP e CX70.261HP</p>		<p>ACX.08.36</p> <p>Descrizione Ween hide 180 cerniera superiore scomparsa - dx ante CX70.260HP e CX70.261HP</p>	
<p>ACX.08.28</p> <p>Descrizione Ween hide 180 braccio corto AR a scomparsa - sx solo per ante CX70.260HP e CX70.261HP</p>		<p>ACX.08.37</p> <p>Descrizione Ween hide 180 cerniera superiore scomparsa - sx ante CX70.260HP e CX70.261HP</p>	
<p>ACX.08.29</p> <p>Descrizione Ween hide 180 braccio corto AR a scomparsa - dx solo per ante CX70.260HP e CX70.261HP</p>	<p>Logica</p>	<p>ACX.08.38</p> <p>Descrizione Ween hide 180 cerniera sup.a scomparsa per anta battente(dx) ante CX70.260HP e CX70.261HP</p>	
<p>ACX.08.30</p> <p>Descrizione Ween hide 180 braccio corto AR a scomparsa - sx solo per ante CX70.260HP e CX70.261HP</p>	<p>Logica</p>	<p>ACX.08.39</p> <p>Descrizione Ween hide 180 cerniera sup.a scomparsa per anta battente(sx) ante CX70.260HP e CX70.261HP</p>	
<p>ACX.08.31</p> <p>Descrizione Ween hide 180 braccio medio AR scomparsa - dx solo per ante CX70.260HP e CX70.261HP</p>		<p>ACX.08.40</p> <p>Descrizione Ween hide 180 kit base anta ribalta con anti falsa manovra sulla cremonese ante CX70.260HP e CX70.261HP</p>	
<p>ACX.08.32</p> <p>Descrizione Ween hide 180 braccio medio AR scomparsa - sx solo per ante CX70.260HP e CX70.261HP</p>		<p>ACX.08.41</p> <p>Descrizione Ween hide 180 kit base anta ribalta con anti falsa manovra sulla cremonese ante CX70.260HP e CX70.261HP</p>	<p>Logica</p>
<p>ACX.08.33</p> <p>Descrizione Ween hide 180 braccio medio AR scomparsa - dx solo per ante CX70.260HP e CX70.261HP</p>	<p>Logica</p>	<p>ACX.08.42</p> <p>Descrizione Martellina ITALIA sporgenza quadro 24 mm, con scatto microventilazione</p>	



<p>ACX.08.43</p> <p>Descrizione Anta ribalta "ween wi-cloud ar" automatica port.max 160 kg</p>		
<p>ACX.08.44</p> <p>Descrizione Catenaccio a leva ad appoggio per anta affiancata Ween</p>		
<p>ARX.09.01</p> <p>Descrizione Attrezzatura Pneumatica</p>		
<p>ACX.09.02</p> <p>Descrizione KIT FRESE</p>		
<p>ACX.20.01</p> <p>Descrizione WI-CLOUD RC Attuatore a catena radiocomandato</p>		
<p>ARX.20.02</p> <p>Descrizione WI-CONTROL Radiocomando</p>		
<p>ACX.20.03</p> <p>Descrizione WI-CLOUD Attuatore a catena radiocomandato</p>		
<p>ACX.20.04</p> <p>Descrizione WI-CLOUD RC-LOCK Attuatore a catena con serratura elettromeccanica</p>		



Guarnizioni

<p>ARX.10.61</p> <p>Descrizione Guarnizione Centrale di Precamera</p>		<p>ARX.10.12</p> <p>Descrizione Guarnizione vetro interna spessore 3 - 4 mm.</p>	
<p>ARX.10.62</p> <p>Descrizione Angolo per guarnizione centrale di Precamera art. ARX.10.61</p>		<p>ARX.10.13</p> <p>Descrizione Guarnizione vetro interna spessore 5 - 6 mm.</p>	
<p>ACX.10.03</p> <p>Descrizione Guarnizione di battuta a scatto</p>		<p>ARX.10.14</p> <p>Descrizione Guarnizione vetro interna spessore 7 - 8 mm.</p>	
<p>ACX.10.04</p> <p>Descrizione Guarnizione di battuta ad infilo</p>		<p>ARX.10.15</p> <p>Descrizione Guarnizione vetro interna spessore 9 - 10 mm.</p>	
<p>ARX.10.05.1</p> <p>Descrizione Guarnizione vetro esterna coestrusa per isolamento termico-acustico</p>		<p>ARX.10.16</p> <p>Descrizione Guarnizione perimetrale</p> 	
<p>ARX.10.07</p> <p>Descrizione Guarnizione di battuta esterna acustica esterna mm.1</p>		<p>ARX.10.27</p> <p>Descrizione Rotella infila guarnizioni</p> 	
<p>ARX.10.08</p> <p>Descrizione Guarnizione di battuta per ferramenta a nastro</p>		<p>ASX.10.35</p> <p>Descrizione Guarnizione rigida per porte</p> 	
<p>ARX.10.09</p> <p>Descrizione Canalina isolante per ferramenta a nastro</p>		<p>ACX.10.71</p> <p>Descrizione Articolo per fermavetro di sicurezza (a pezzi)</p> 	
<p>ARX.10.10</p> <p>Descrizione Spazzola a pavimento</p>		<p>LS 02 Listello isolante 35 x 18 mm.</p> <p>LS 05 Listello isolante 95 x 18 mm.</p> <p>LS 09 Listello isolante 28 x 6 mm.</p> <p>LS 10 Listello isolante 35 x 7.5 mm.</p> <p>LS 11 Listello isolante 49 x 7.5 mm.</p> <p>LS 12 Listello isolante 95 x 7.5 mm.</p> 	

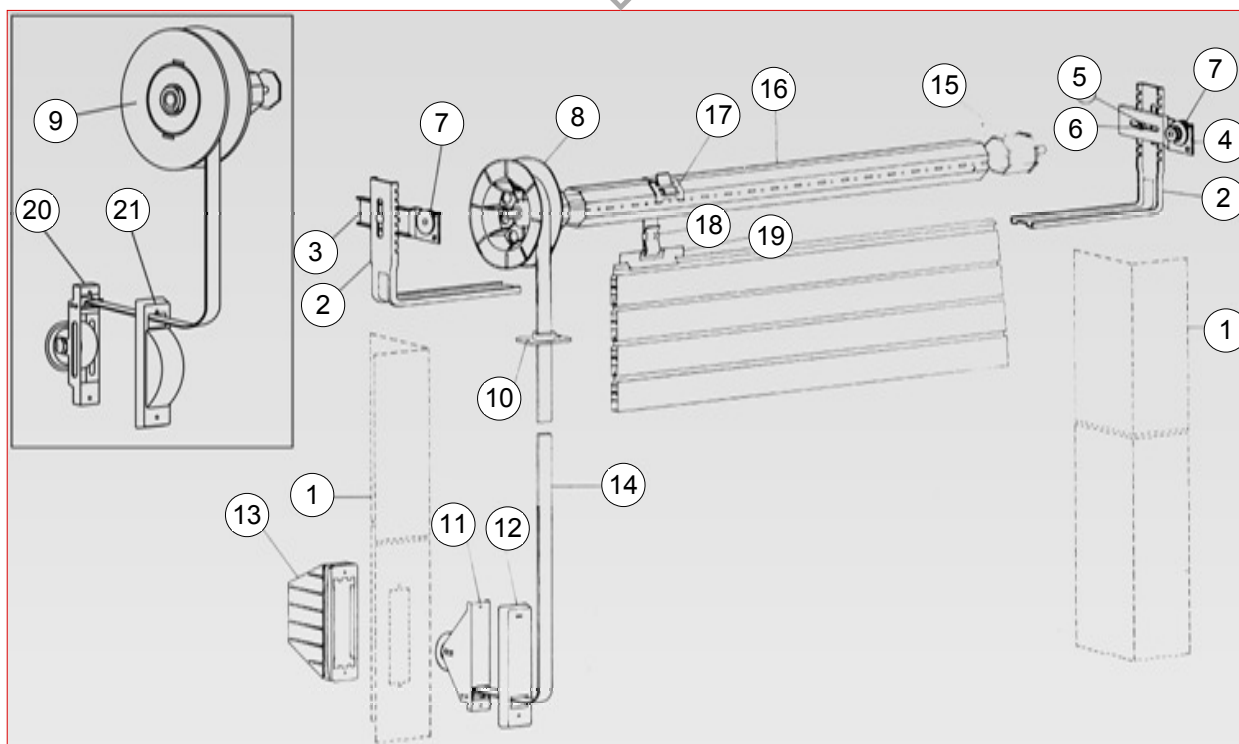
Monoblocco - Soluzione con puleggia

ARX.11.01	Supporto a squadro A = mm 46	2		2
ARX.11.02	Mensola per supporto (SIN)	1		3
ARX.11.03	Mensola per supporto (DX)	1		4
ARX.11.04	Vite 6 x 20 con dado	2		5 - 6
ARX.11.05	Boccola in nylon	2		7
ARX.11.06	Puleggia in plastica a minimo ingombro Ø 220	1	scegliere tipo	8
ARX.11.07	Guida cinghia trasversale in nylon	1	scegliere colore	10
ARX.11.08	Avvolgitore	1		11
ARX.11.09	Placca	1	scegliere tipo	12
ARX.11.10	Cassetta	1	scegliere tipo	13
ARX.11.11	Cintino	Mt.	scegliere tipo	14
ARX.11.12	Calotta in plastica	1		15
ARX.11.13	Rullo ottagonale	Mt.	scegliere tipo	16
ARX.11.14	Gancio per attacco cintino al rullo	2		17
ARX.11.15	Grappa fermacintino	2		18
ARX.11.16	Gancio per avvolgibili in plastica con asola	2		19

Monoblocco - Soluzione con puleggia

ARX.11.18	Riduttore portata 40 kg. R=1:2,6 Puleggia Ø 220	1		9
ARX.11.19	Avvolgitore	1		20
ARX.11.20	Placca	1	scegliere tipo	21

Vari

ARX.11.21	Invito tapparella in nylon su profilo in alluminio
ARX.11.22	Coppia tappi laterali cassonetto in alluminio

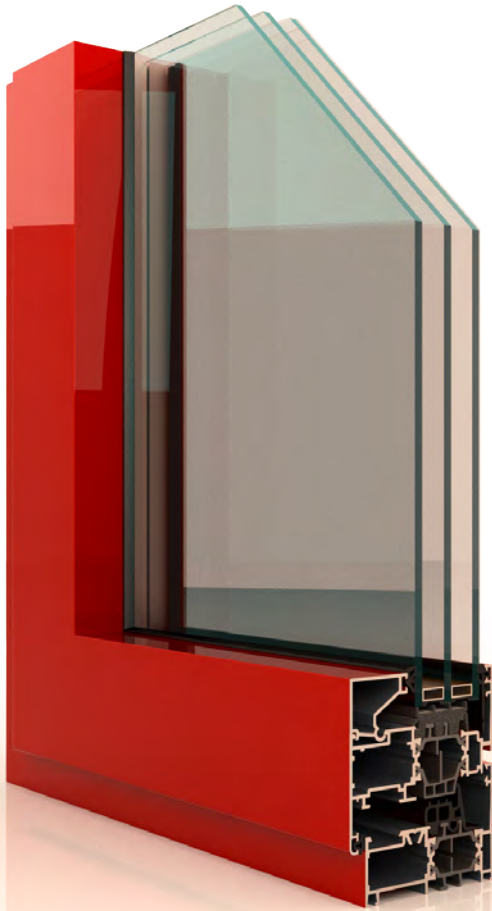

Sezioni

Gruppo D



SCHEMA DIMENSIONALE

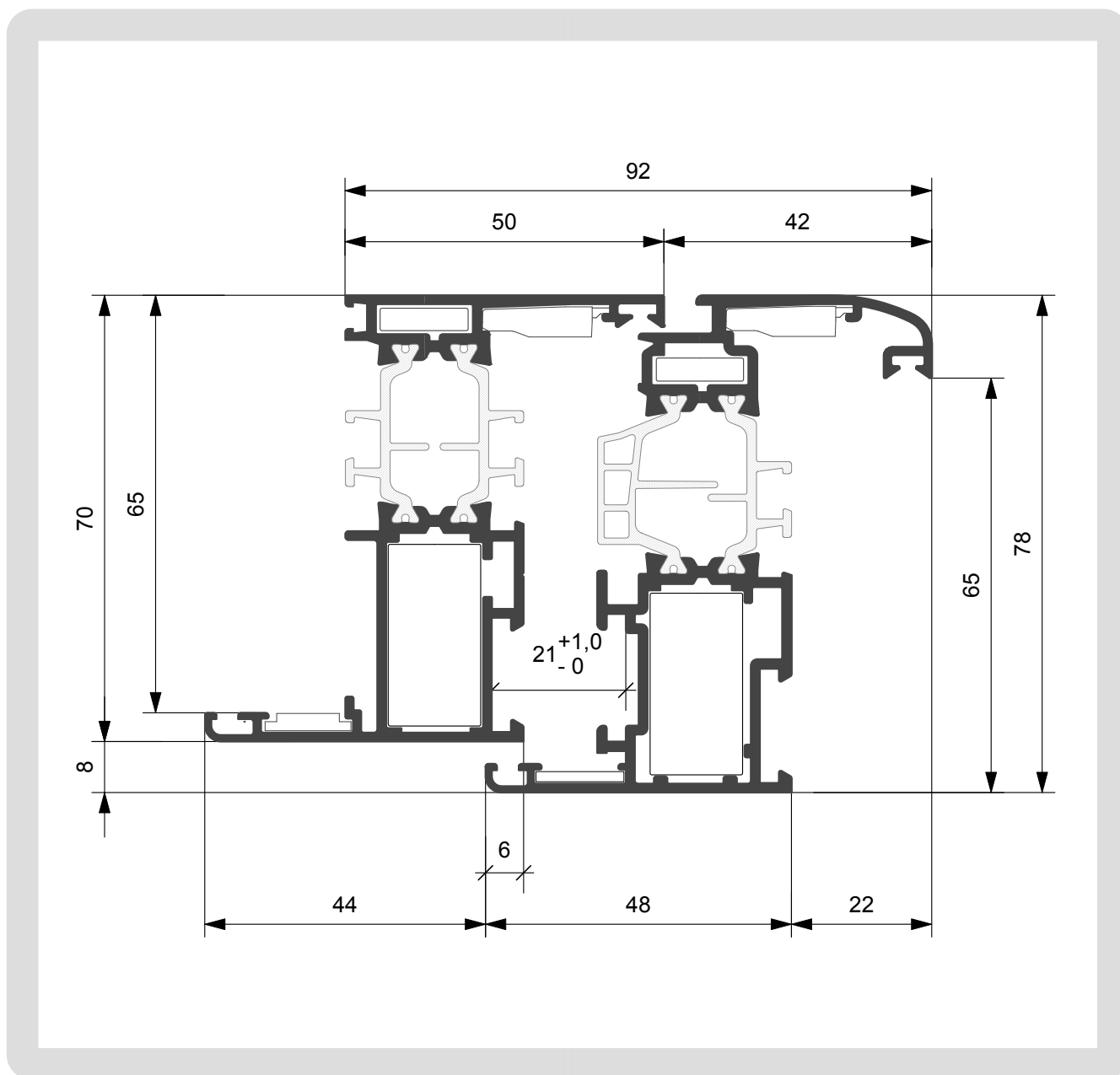



FINESTRA A DUE ANTE

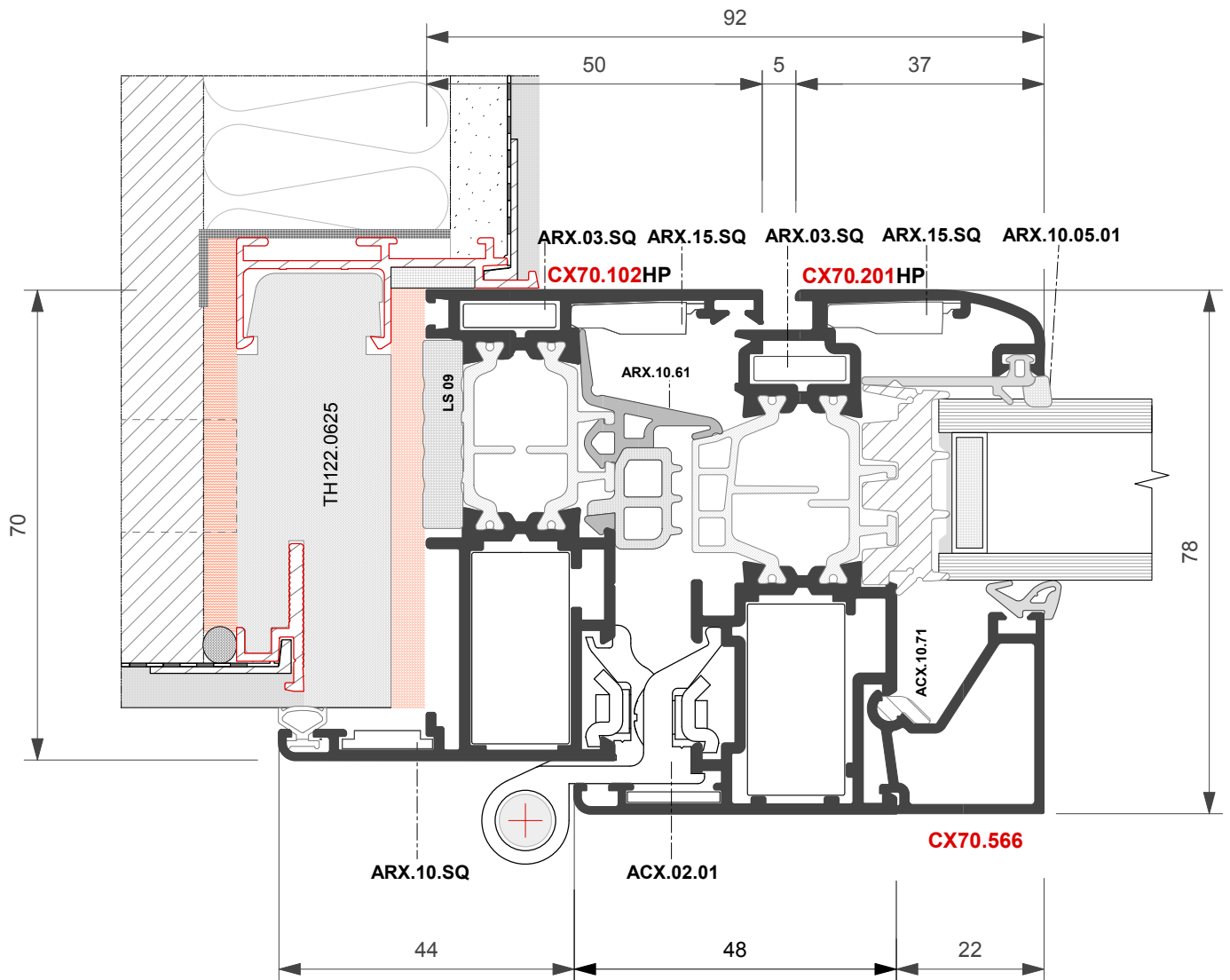
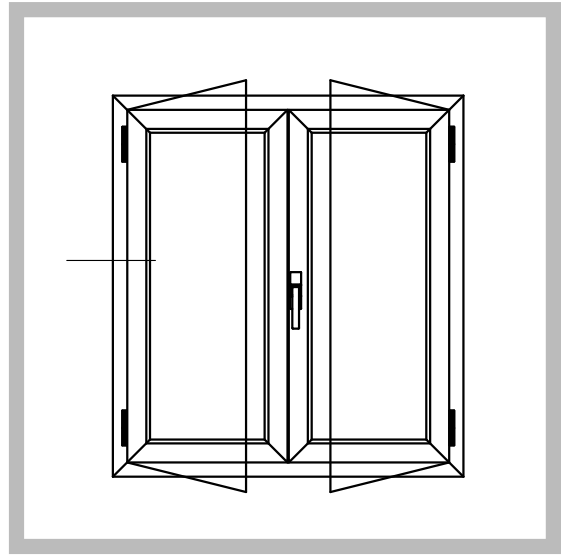



FINESTRA A DUE ANTE

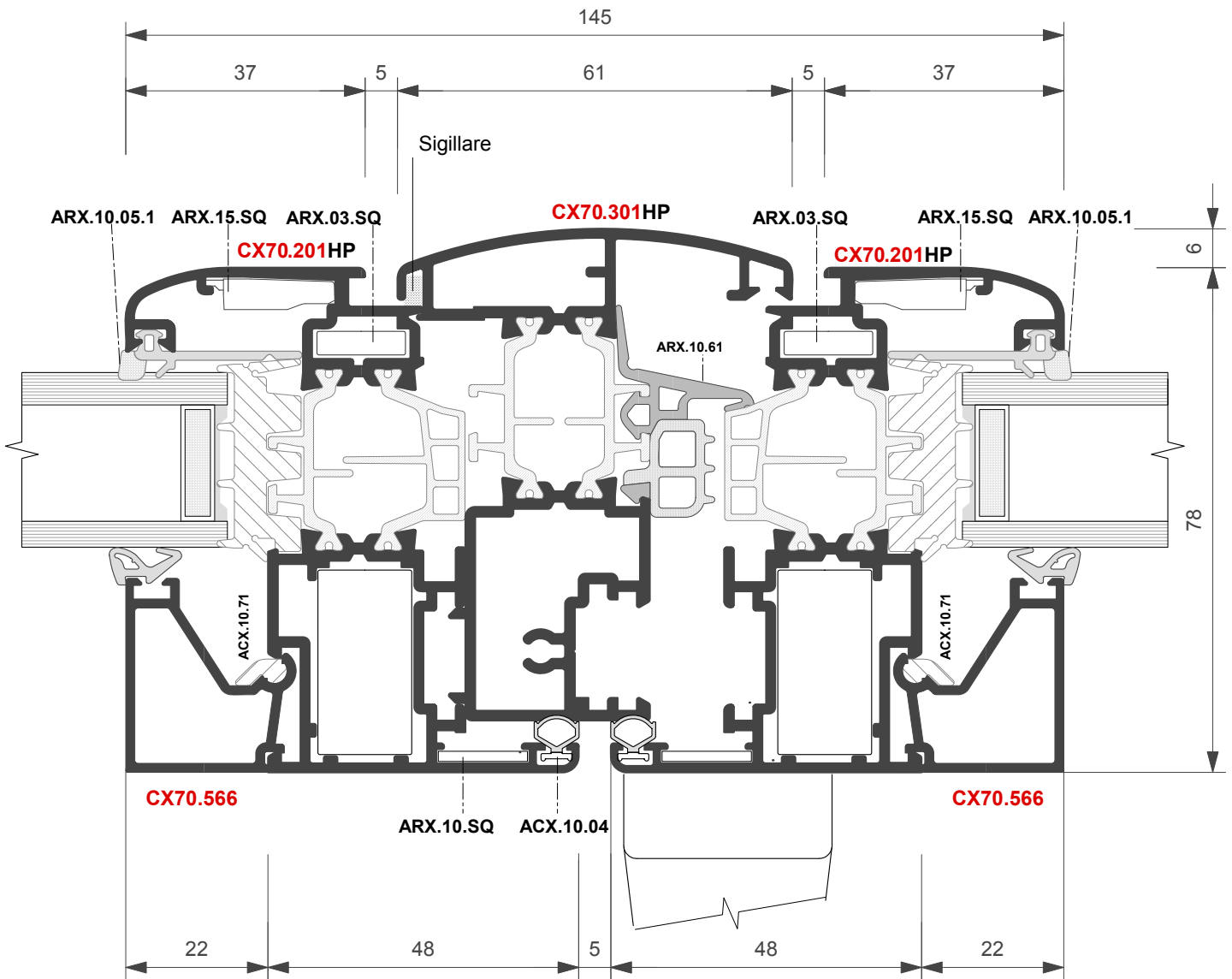
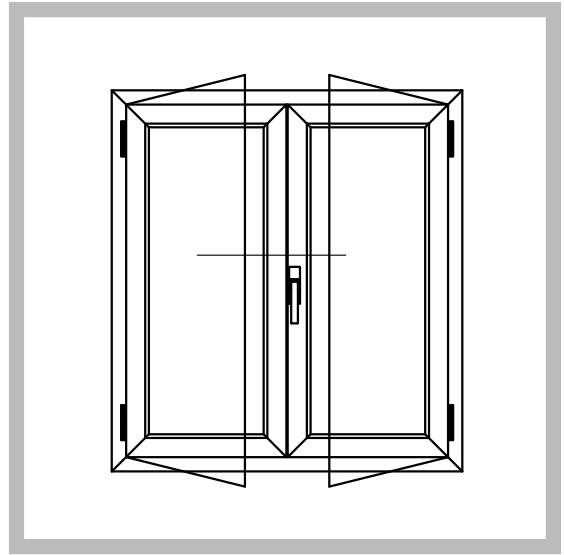



FINESTRA A DUE ANTE

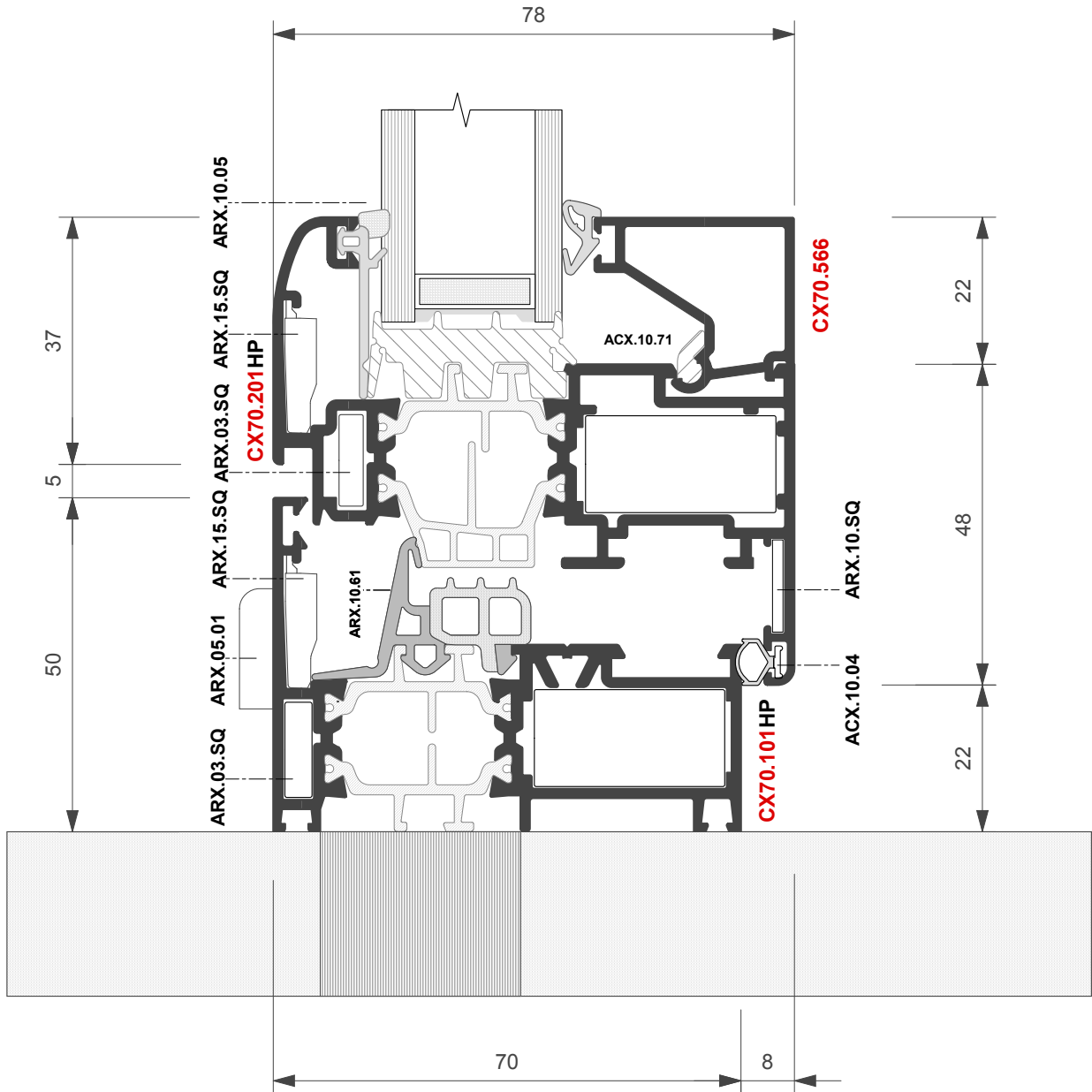
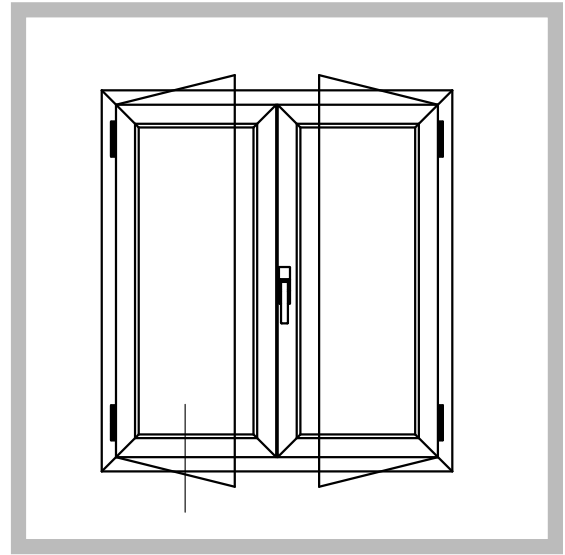



PORTA BALCONE A DUE ANTE

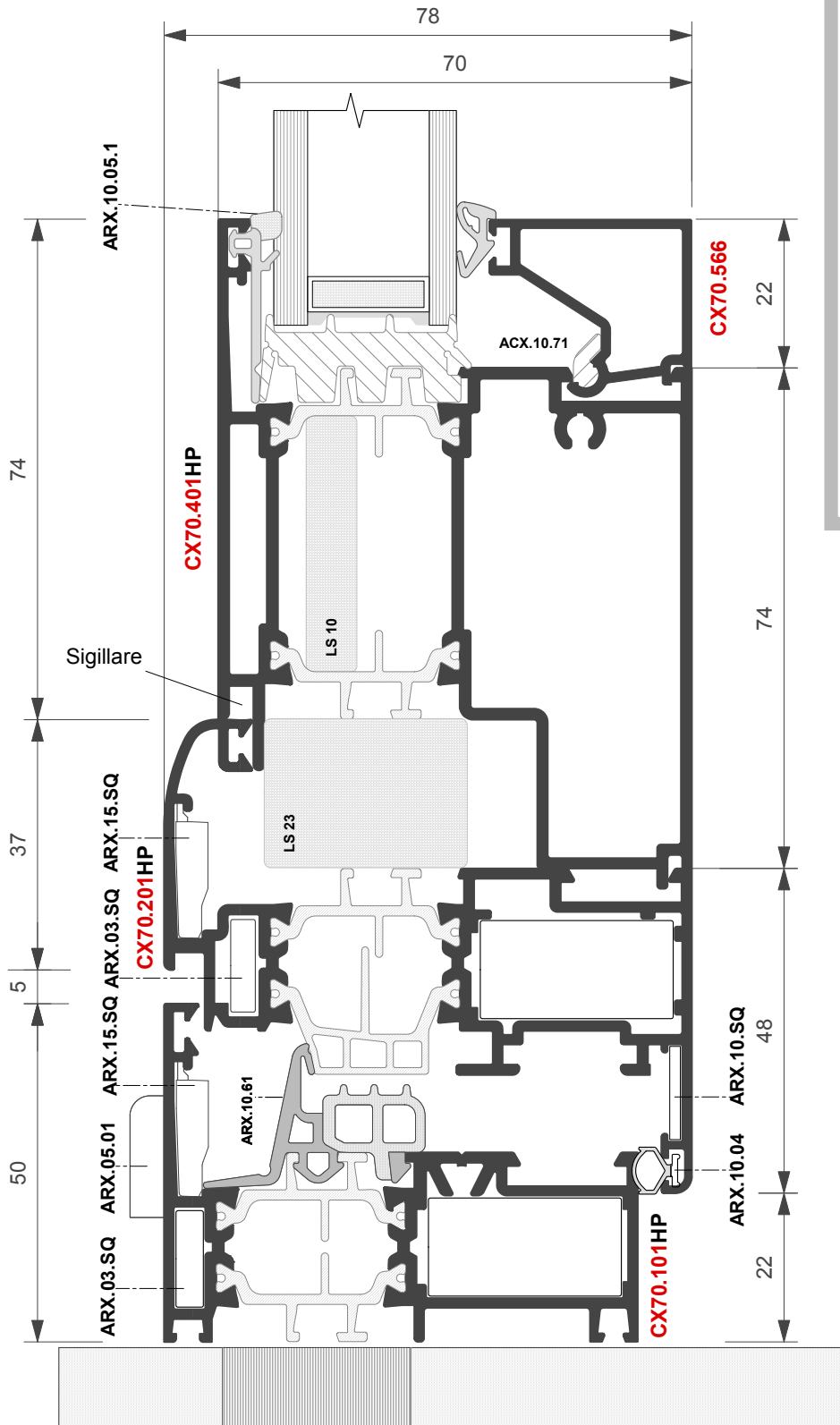
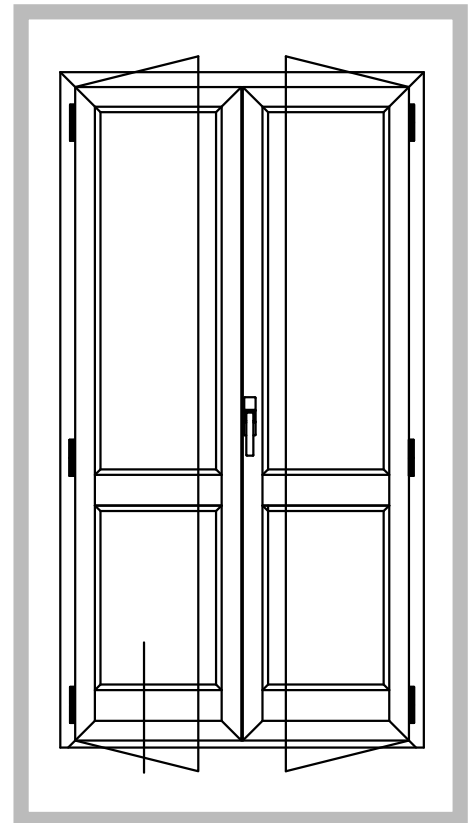



PORTA BALCONE A DUE ANTE
con soglia bassa

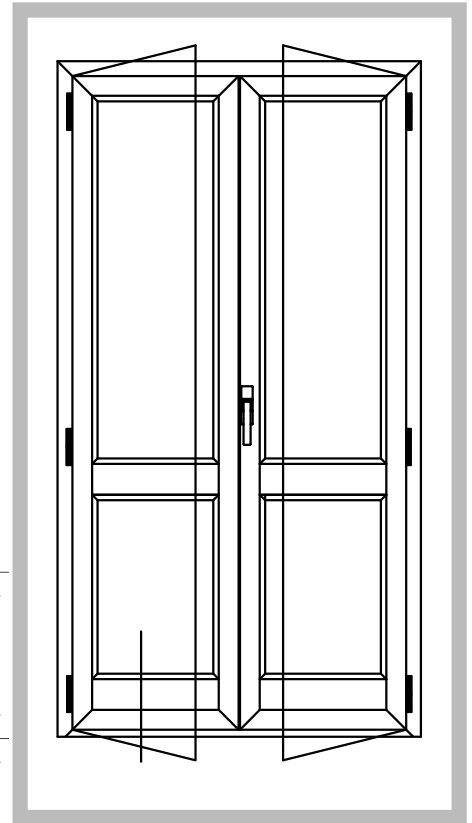
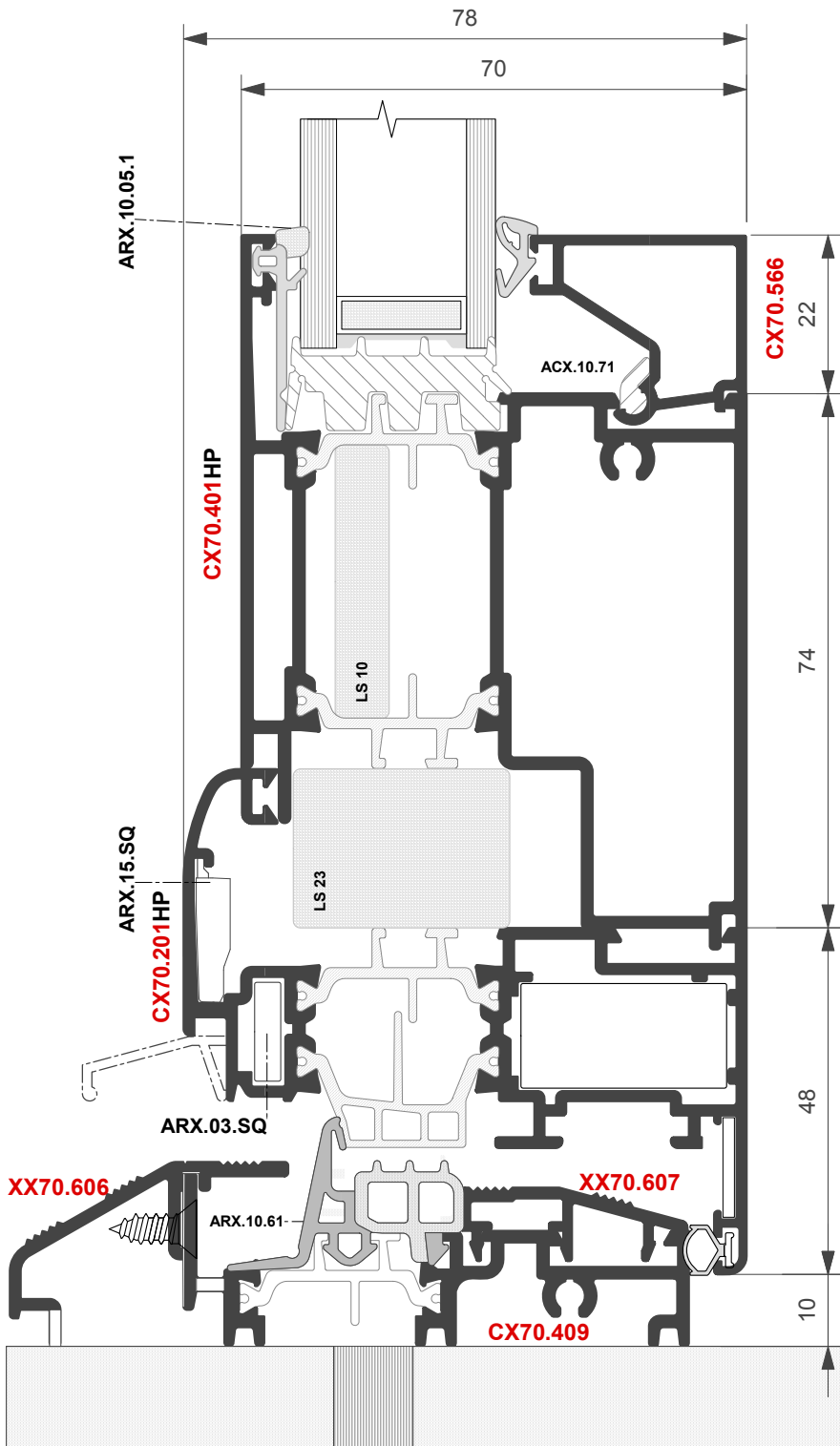



PORTA BALCONE A DUE ANTE

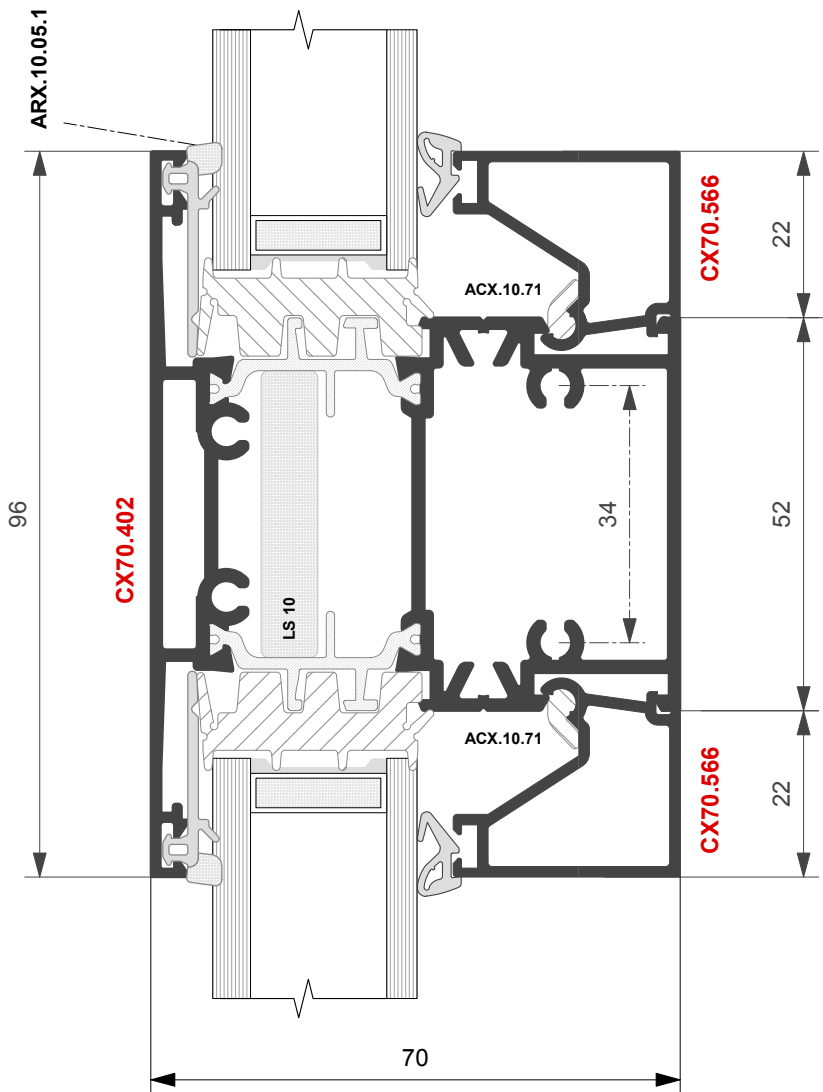
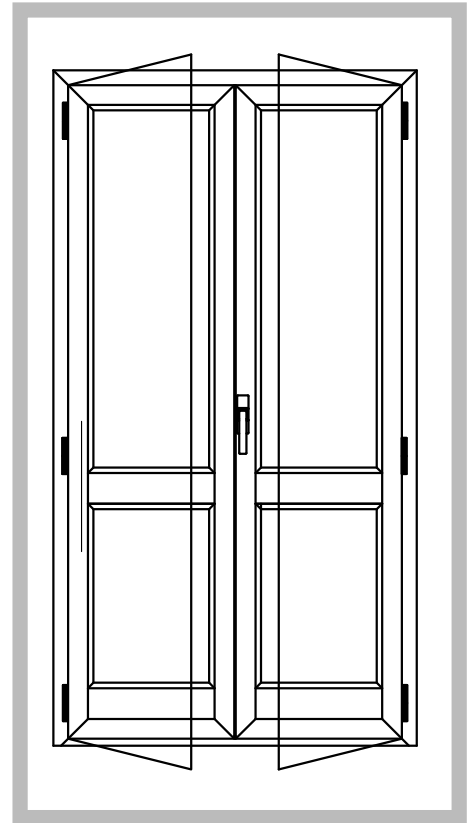



FINESTRA A DUE ANTE

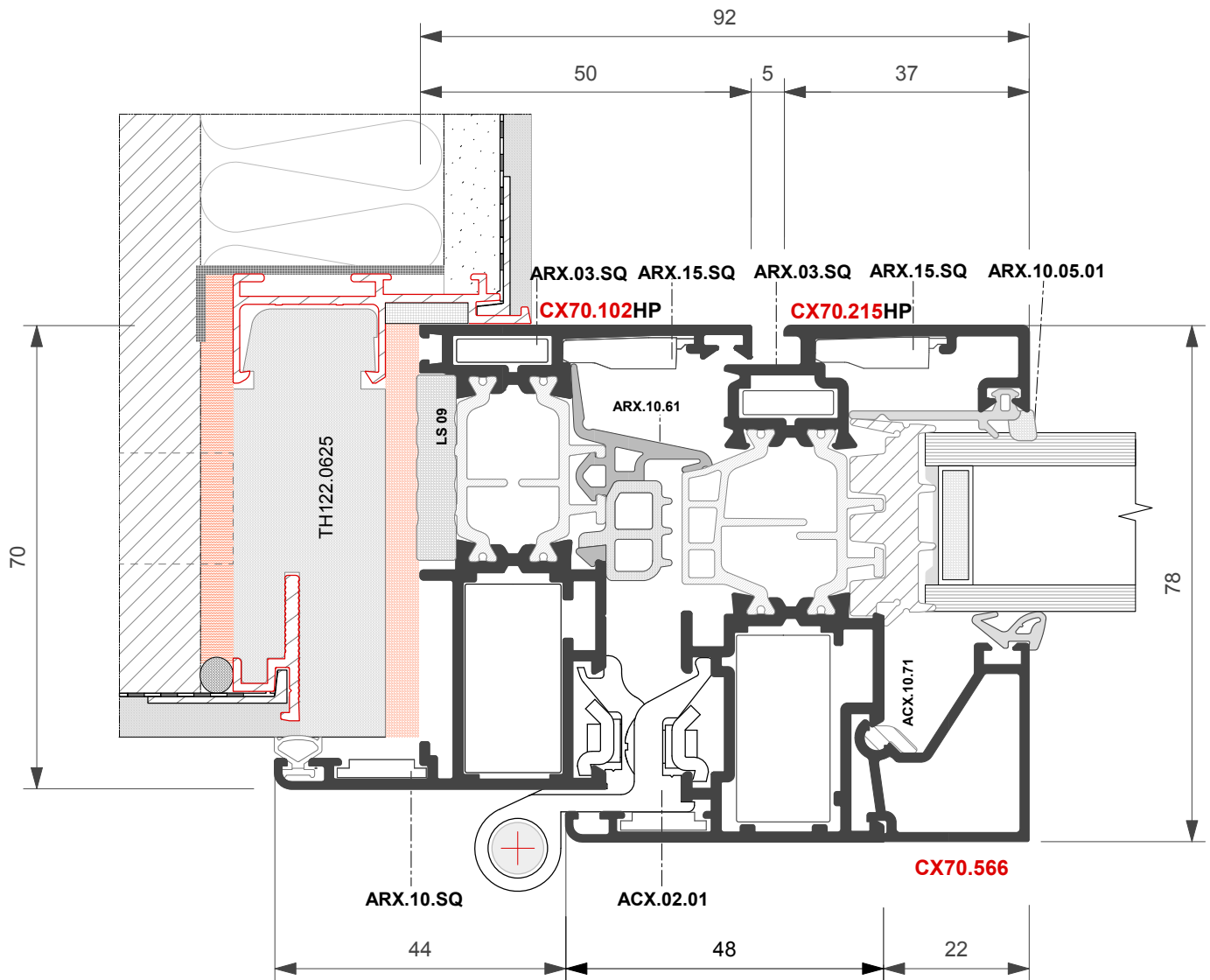
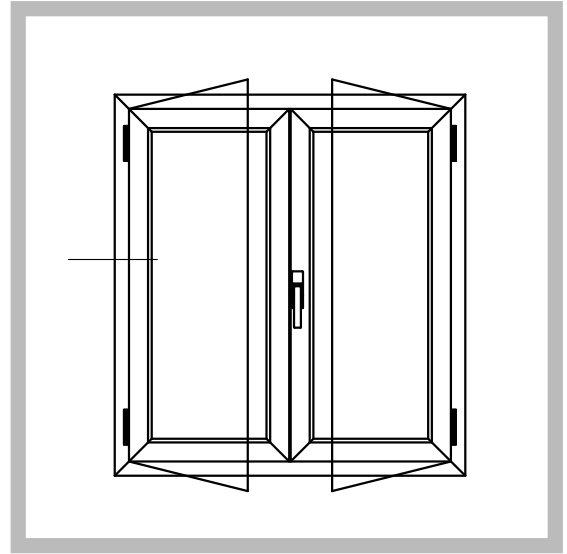



FINESTRA A DUE ANTE

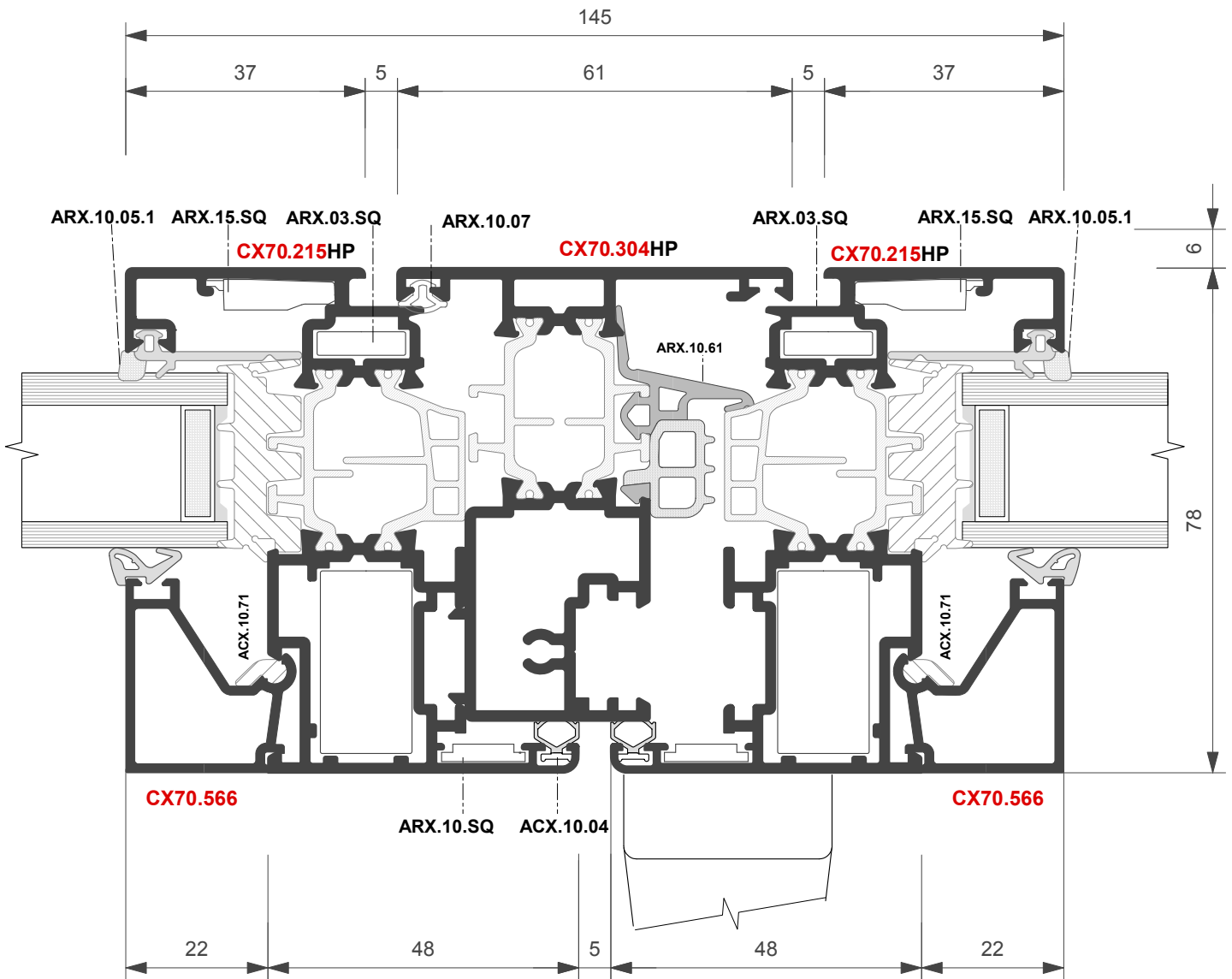
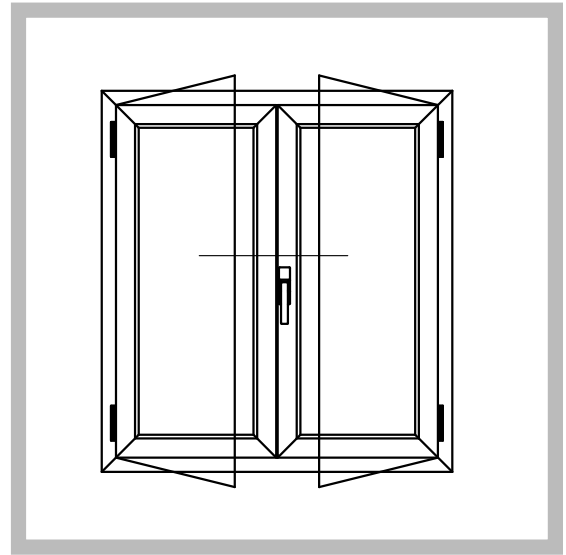



FINESTRA A DUE ANTE

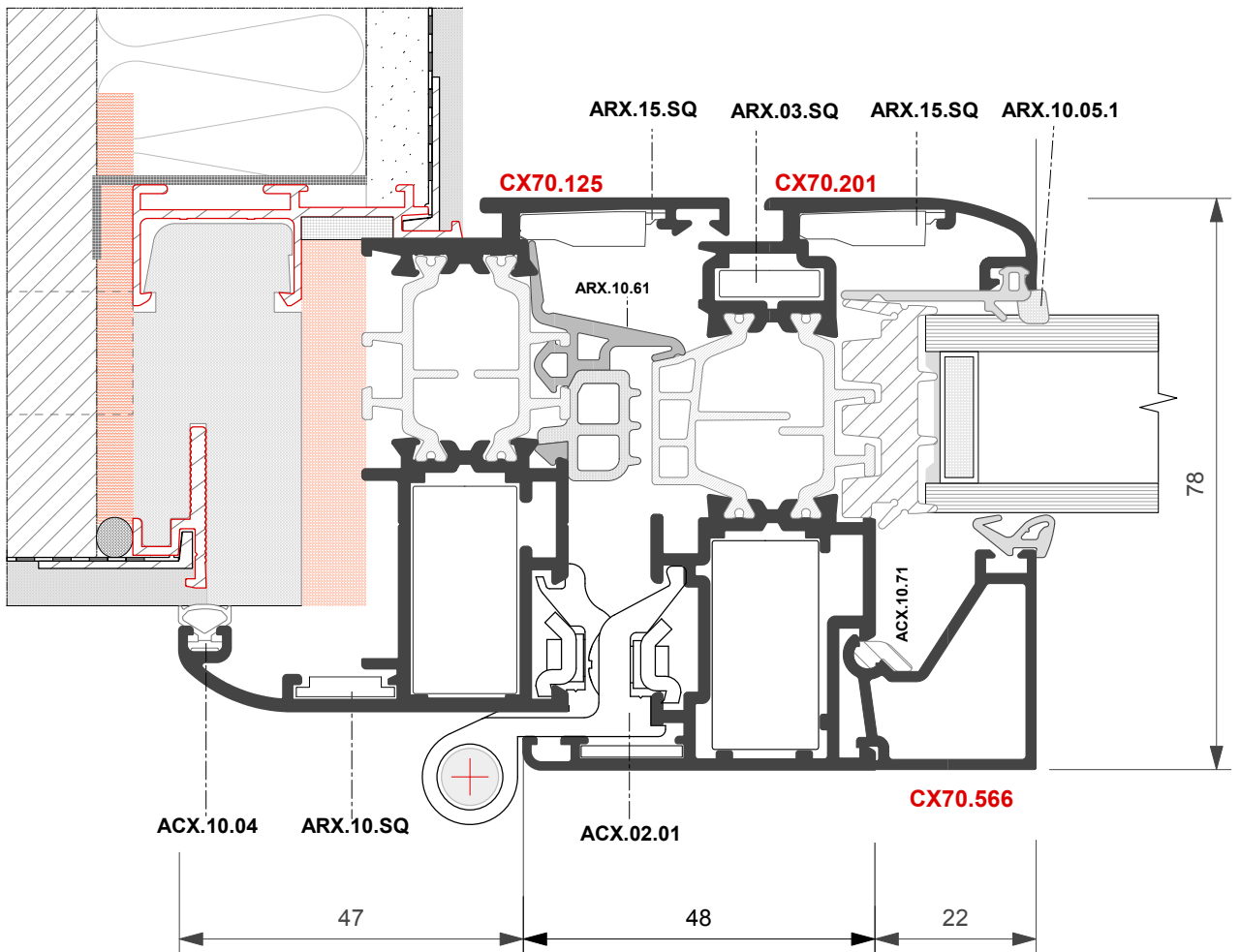
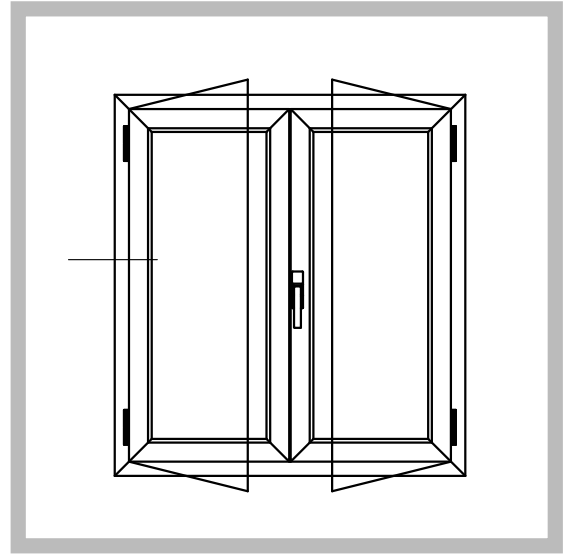



FINESTRA A DUE ANTE
Vetro ad infilare

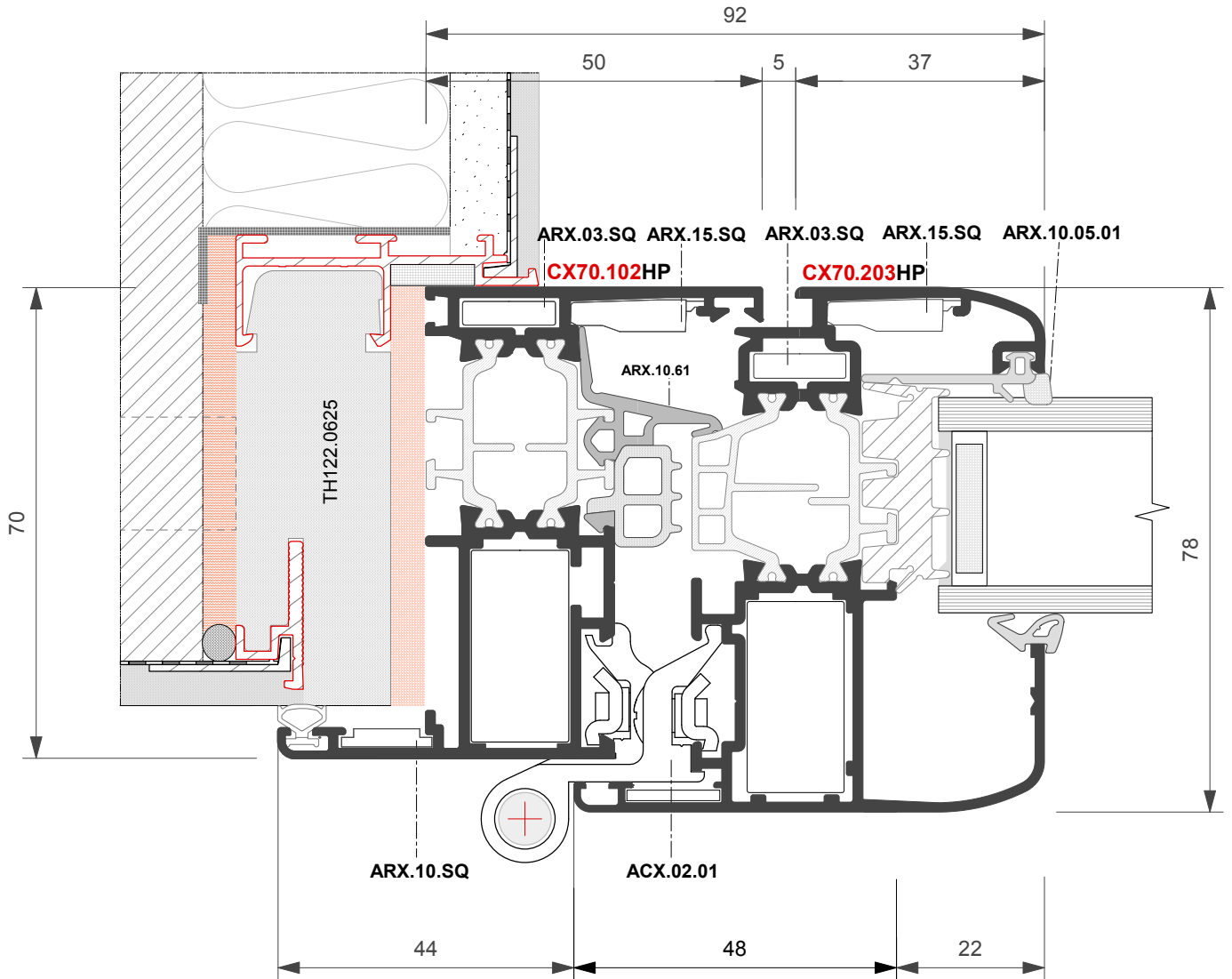
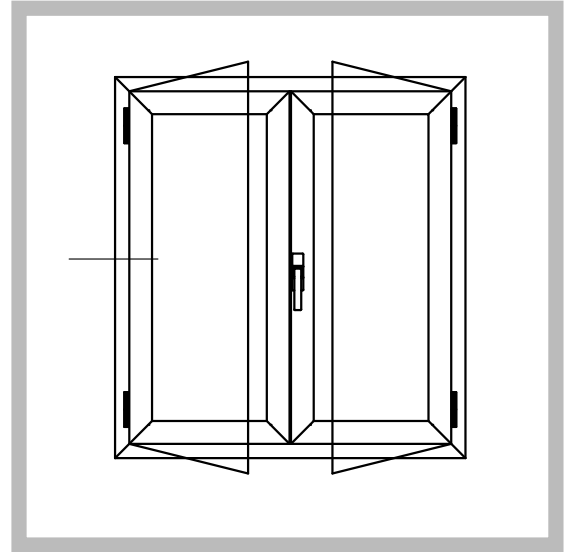



FINESTRA A DUE ANTE
Vetro ad infilare

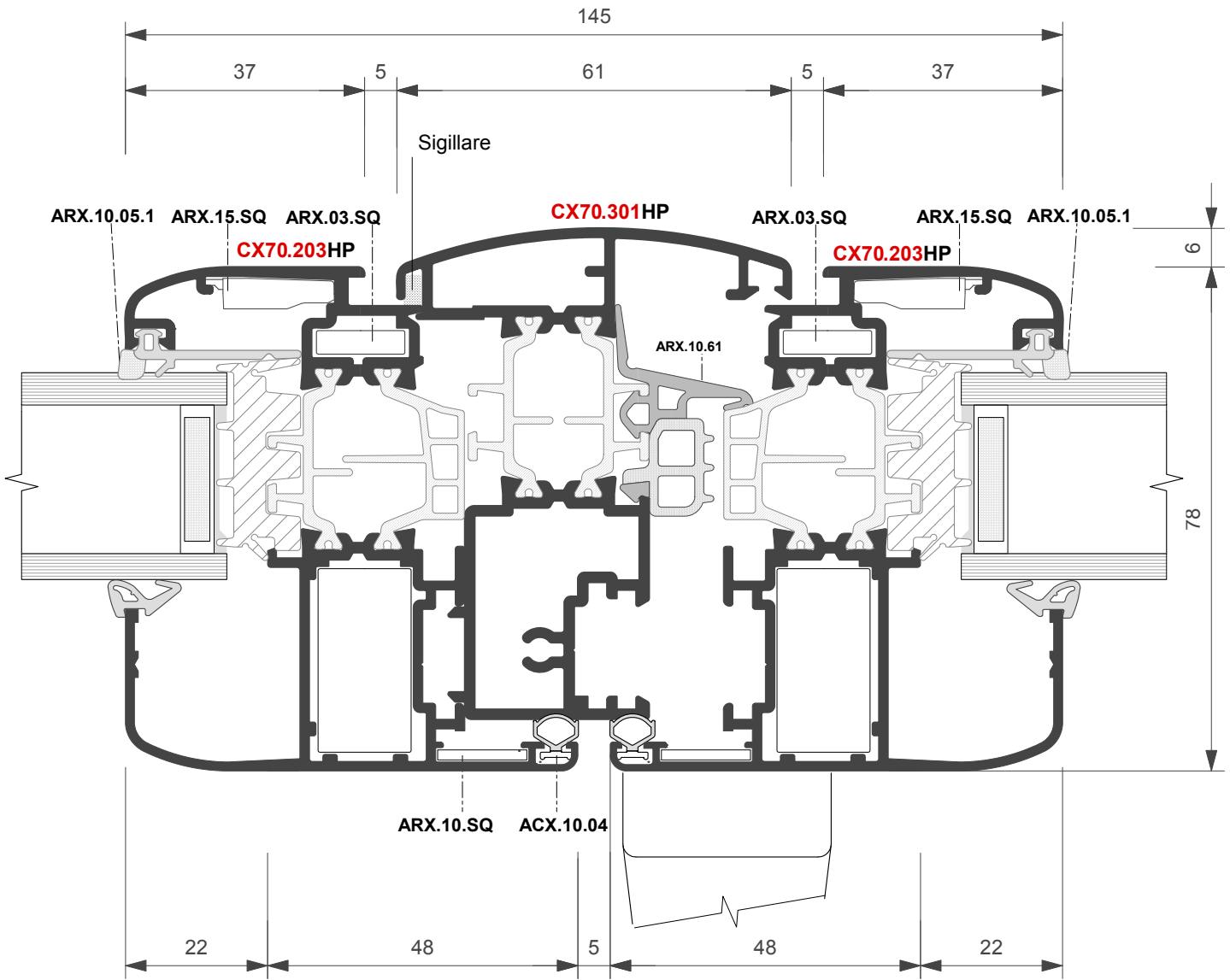
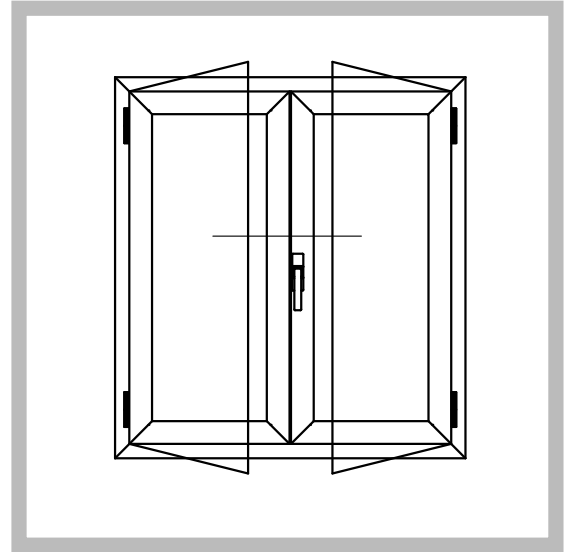



PORTA BALCONE A DUE ANTE
Vetro ad infilare

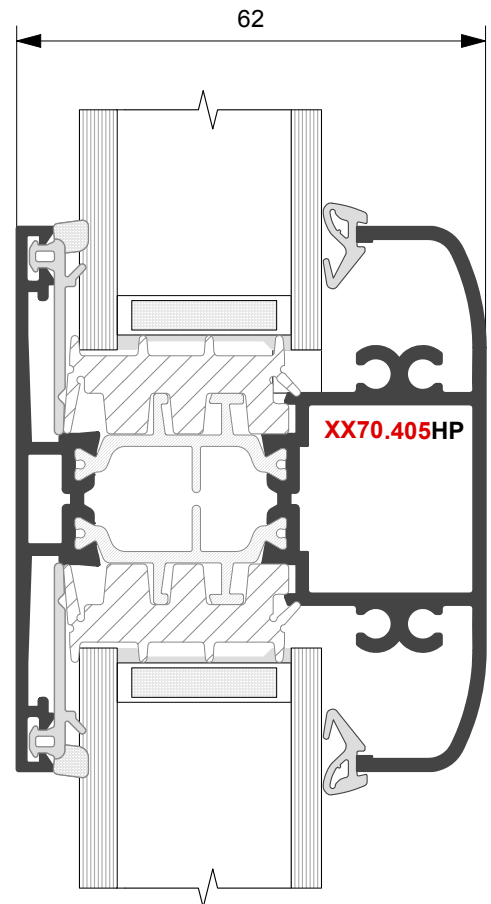
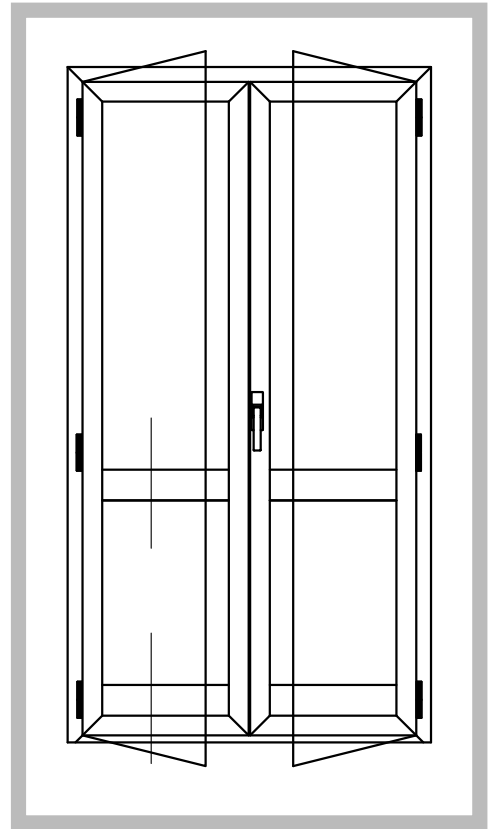
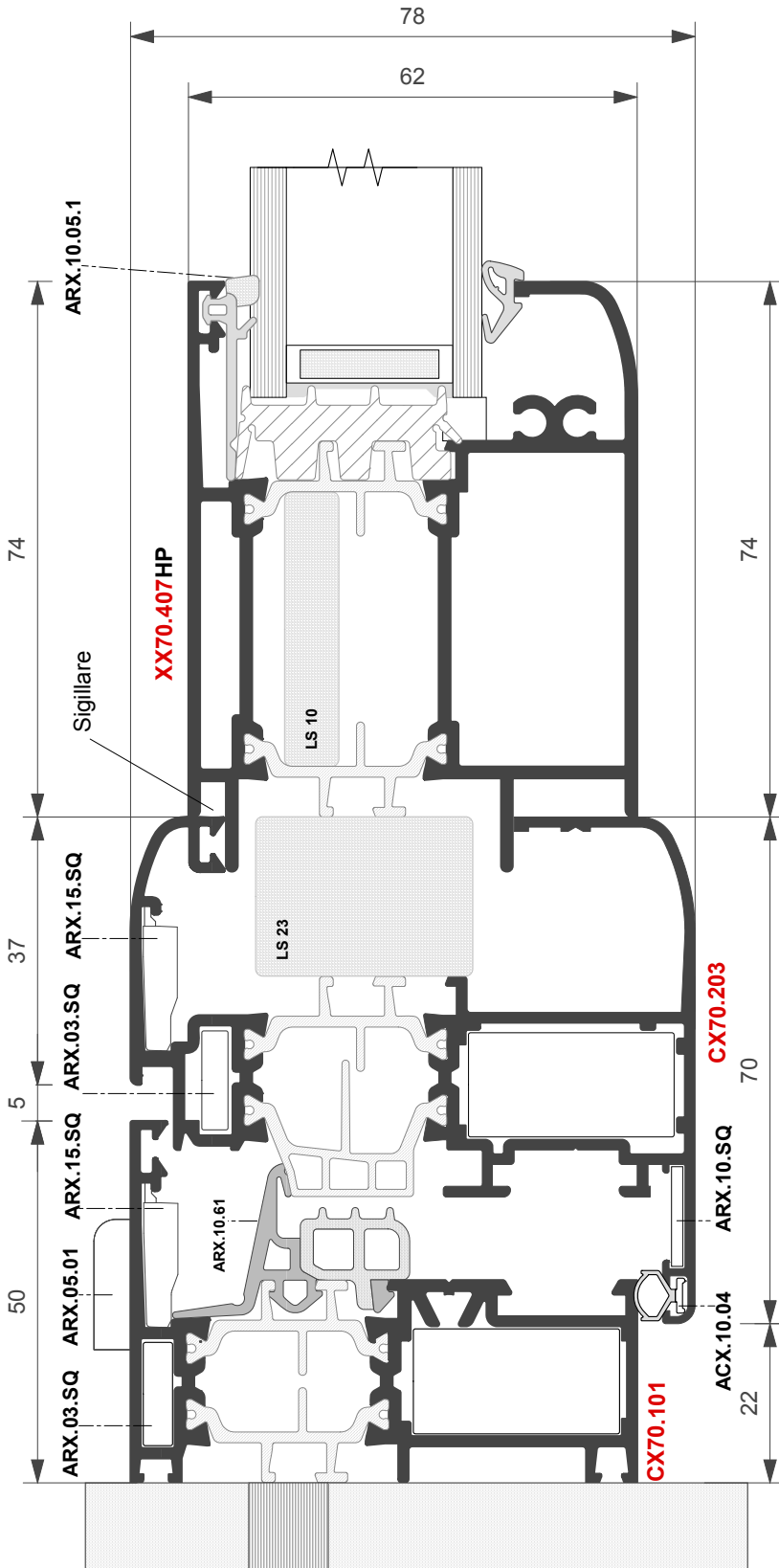



FINESTRA A DUE ANTE
Vetro ad infilare

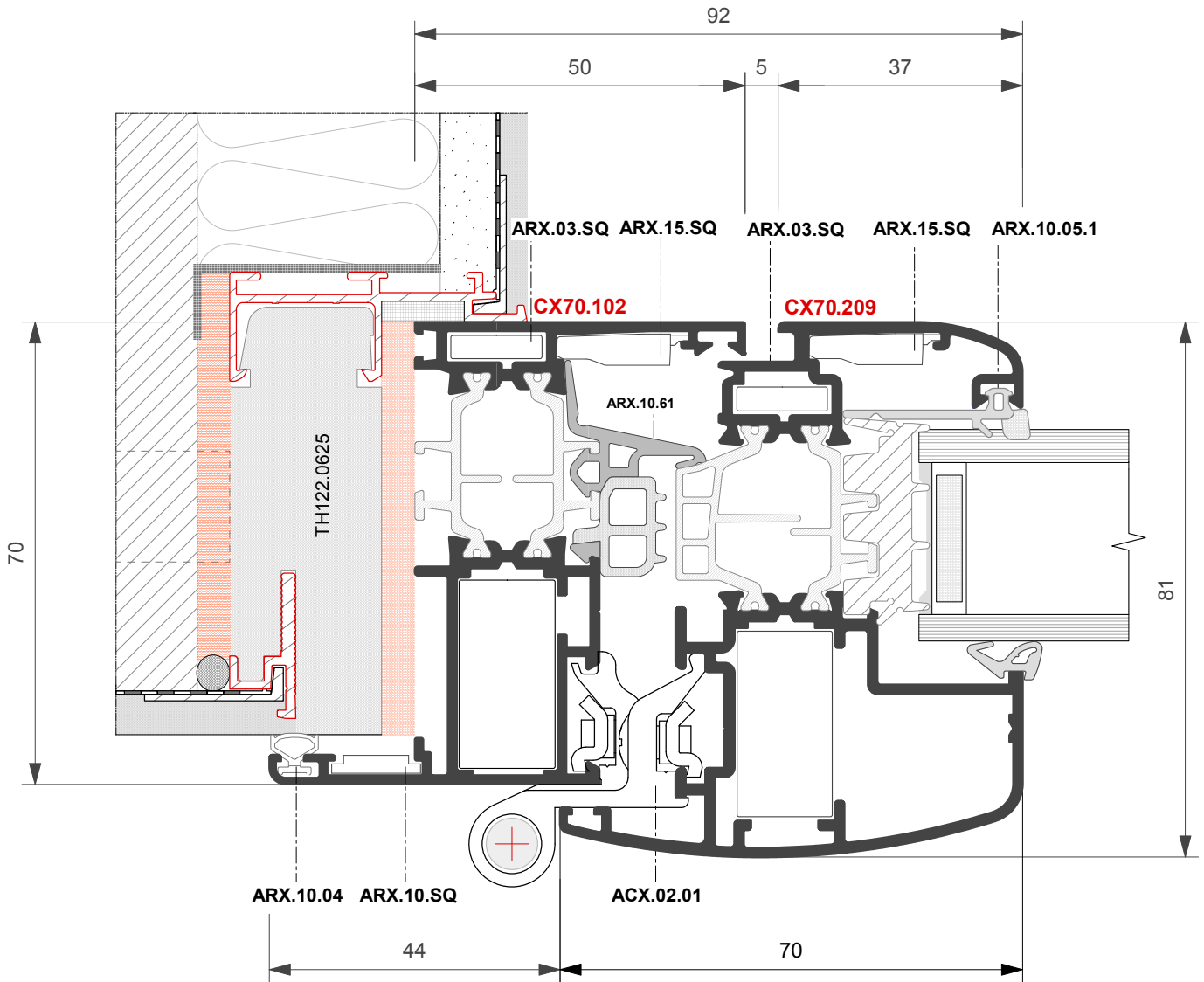
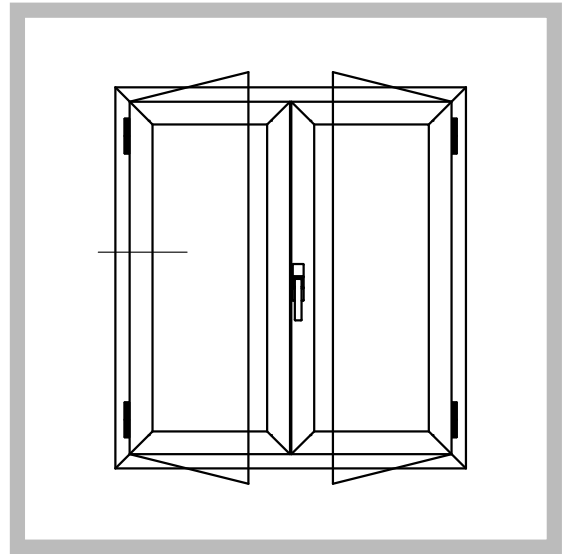



FINESTRA A DUE ANTE
Vetro ad infilare

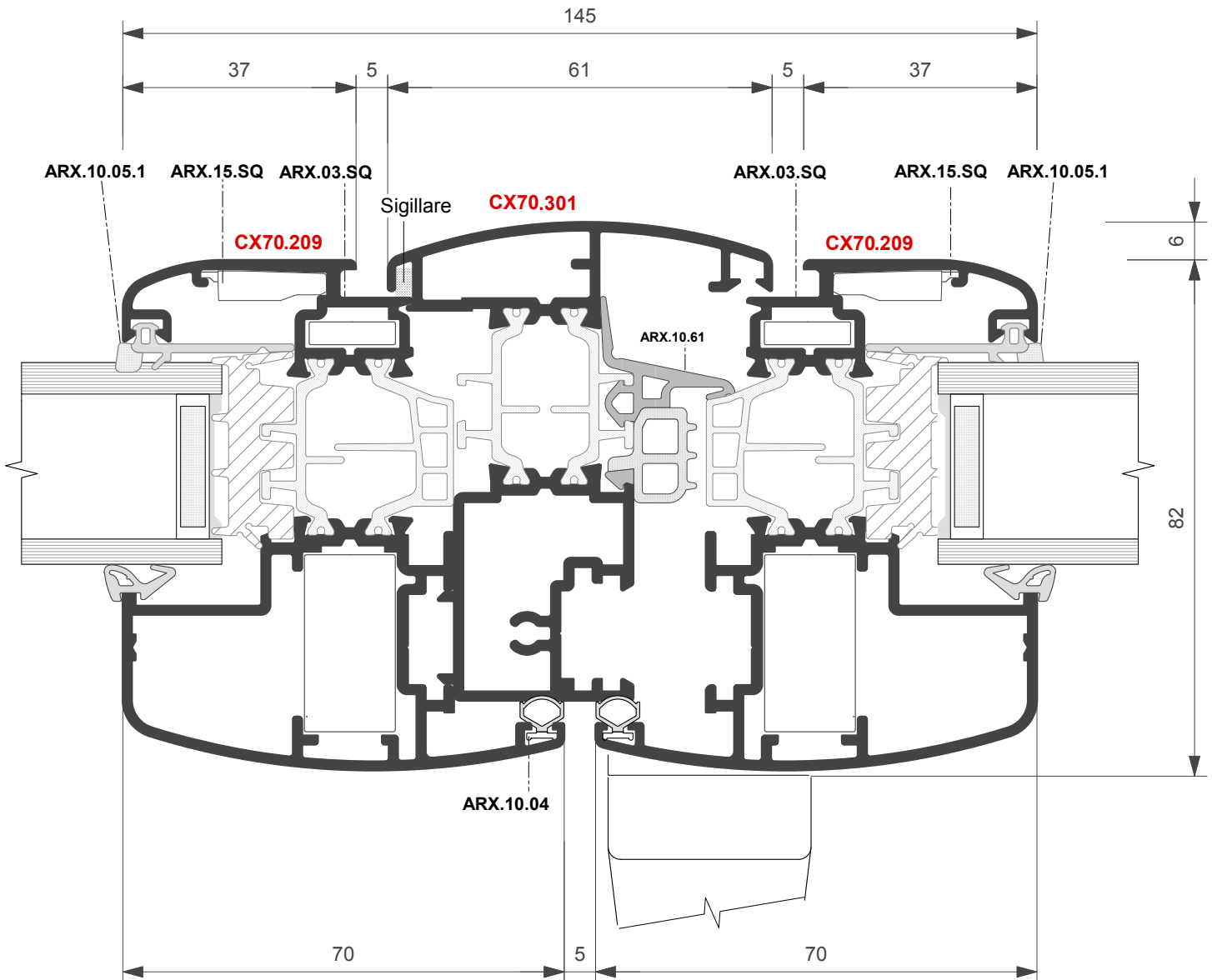
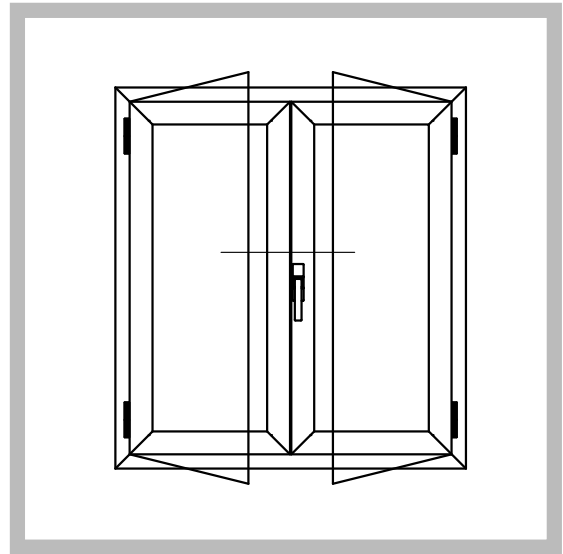



FINESTRA A DUE ANTE
Vetro ad infilare

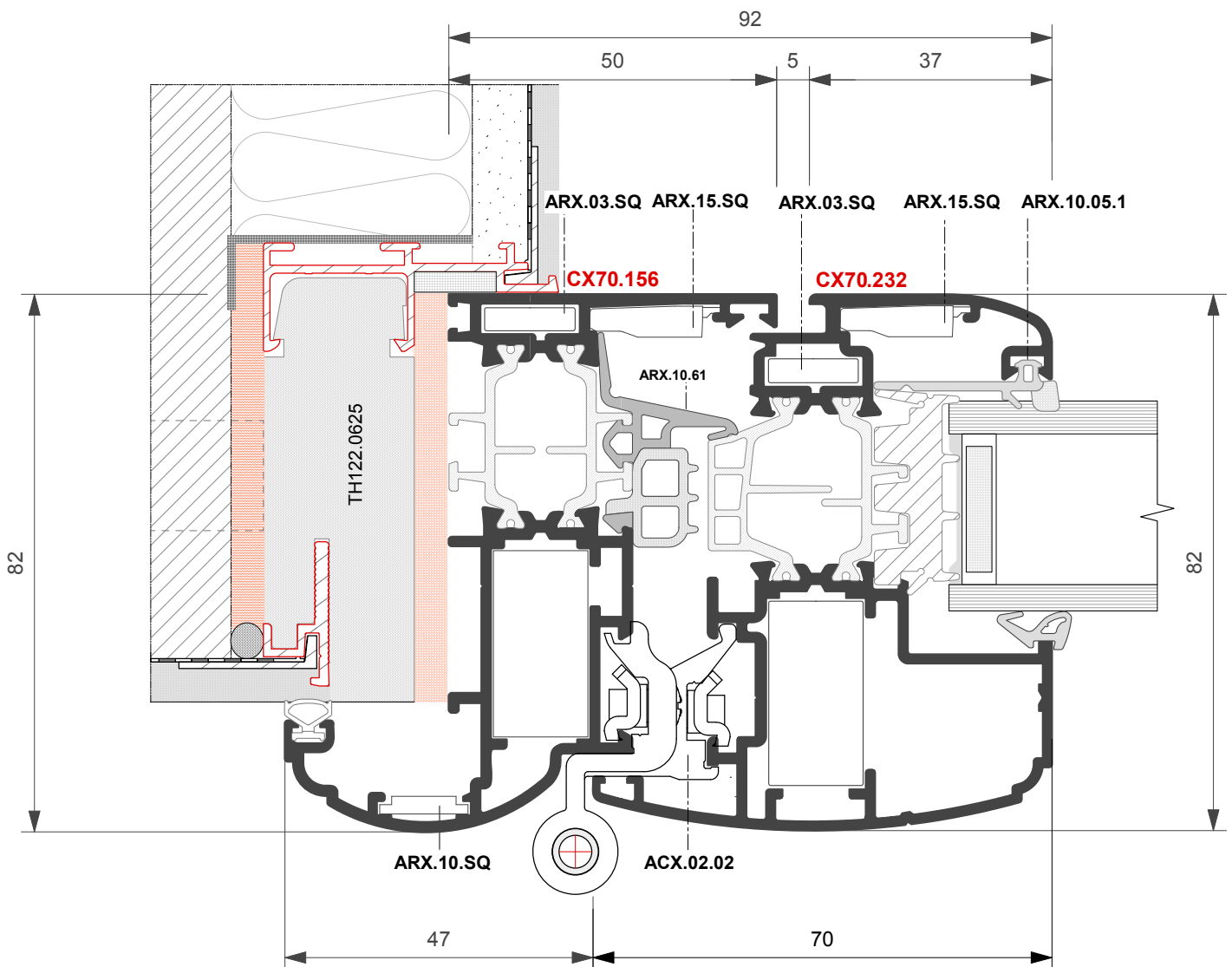
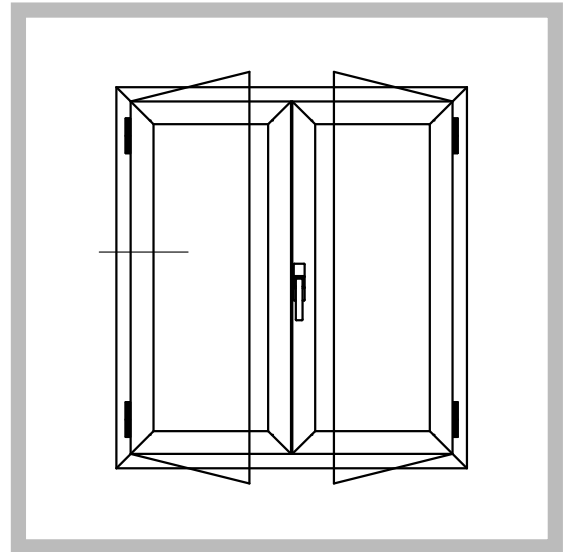



FINESTRA A DUE ANTE
Vetro ad infilare

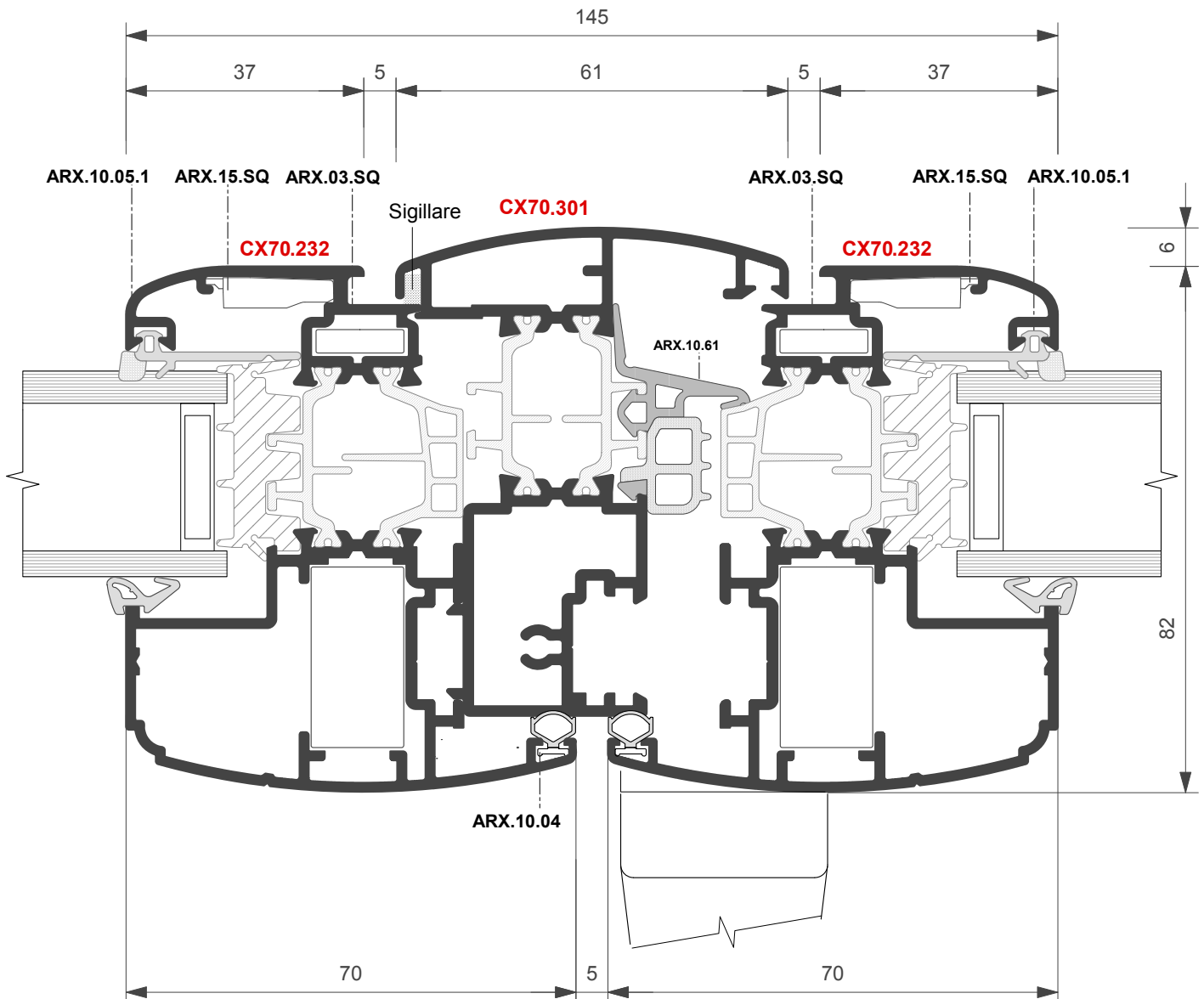
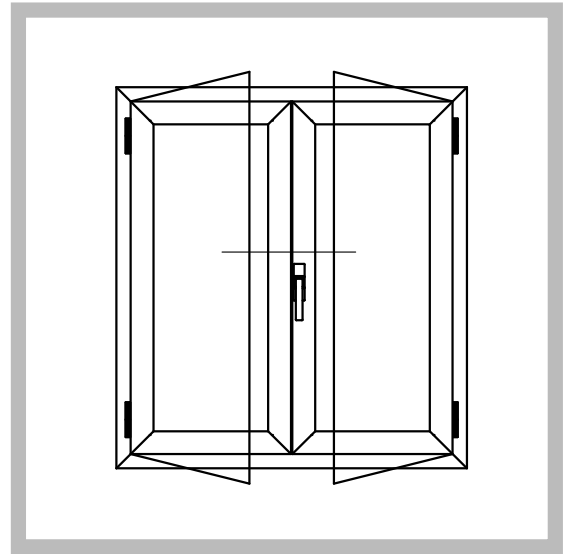



PORTA BALCONE A DUE ANTE
Vetro ad infilare

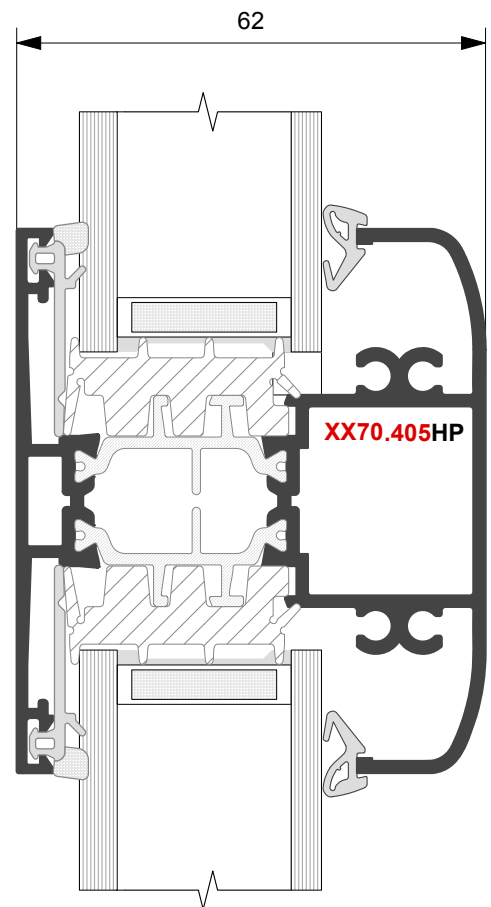
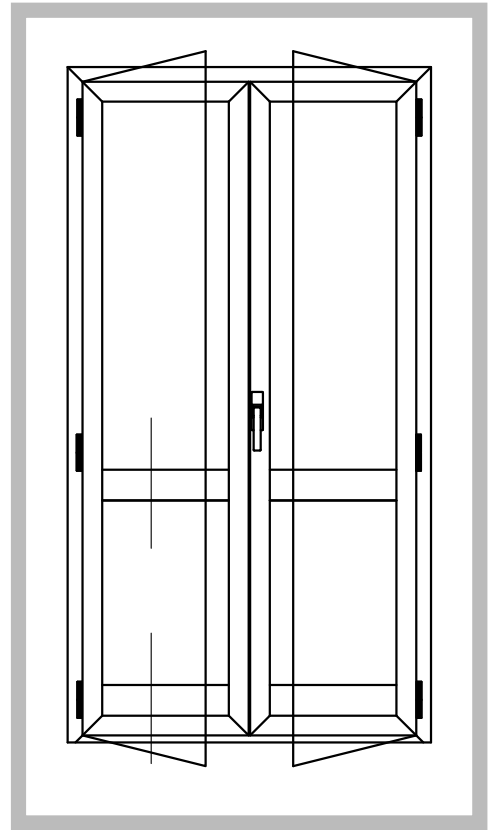
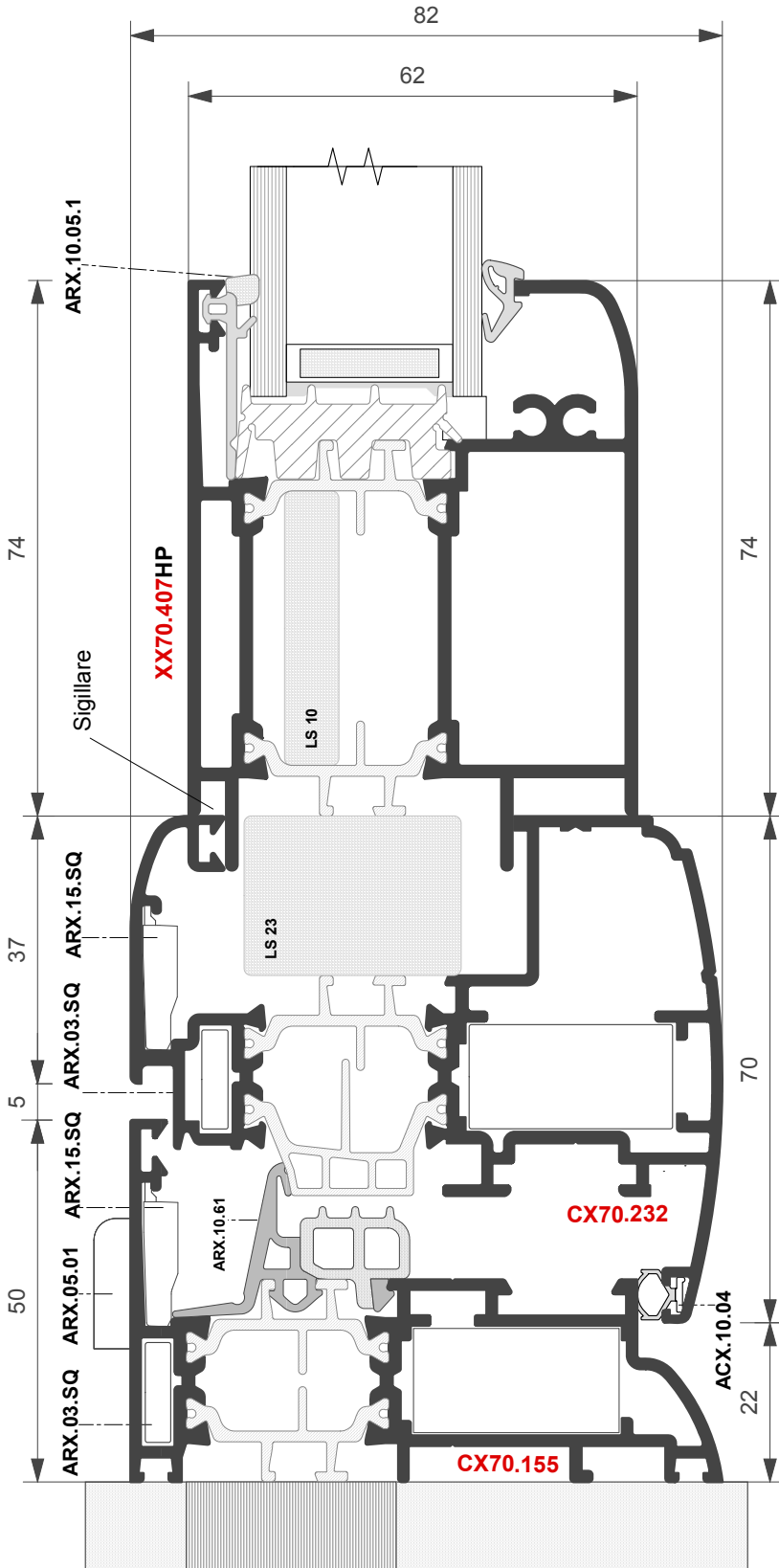

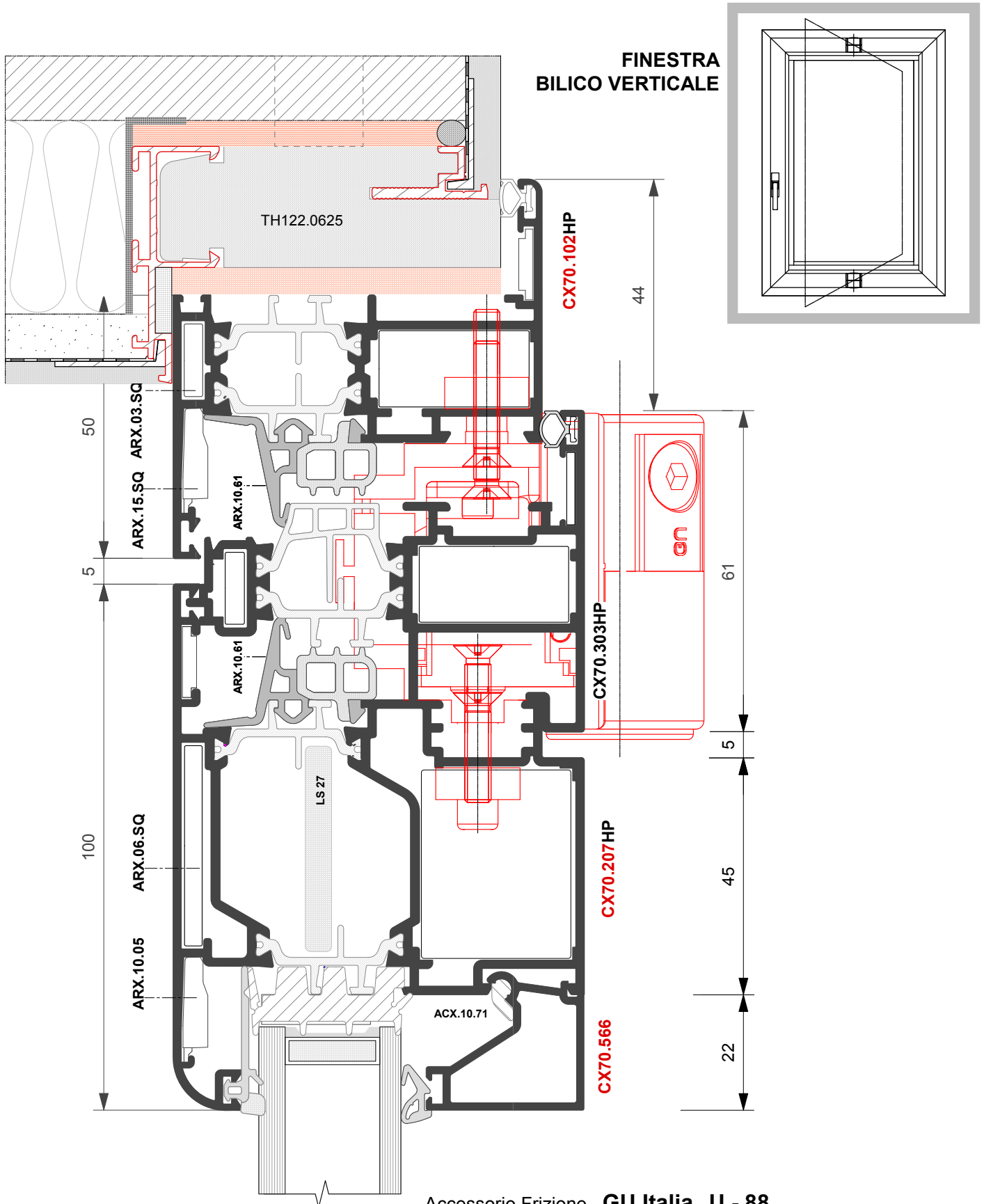

Accessorio Frizione **GU Italia U - 88**
Articolo 6 - 27337-08 - P
 per accessori di movimentazione riferirsi
 alla tavola di assieme

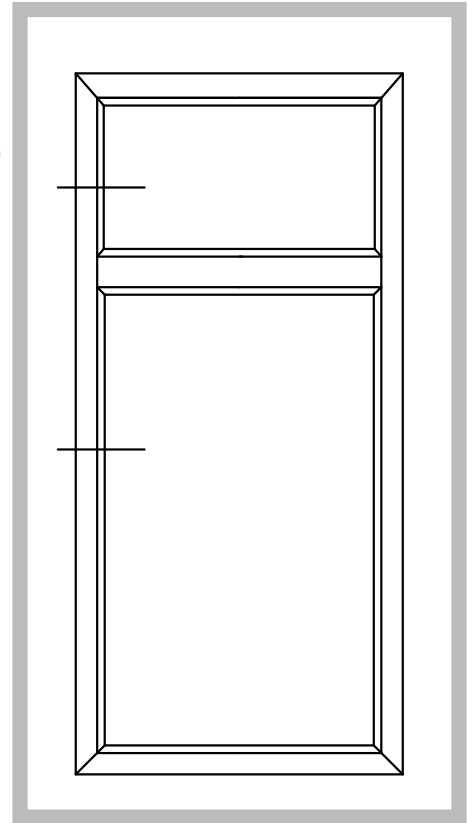
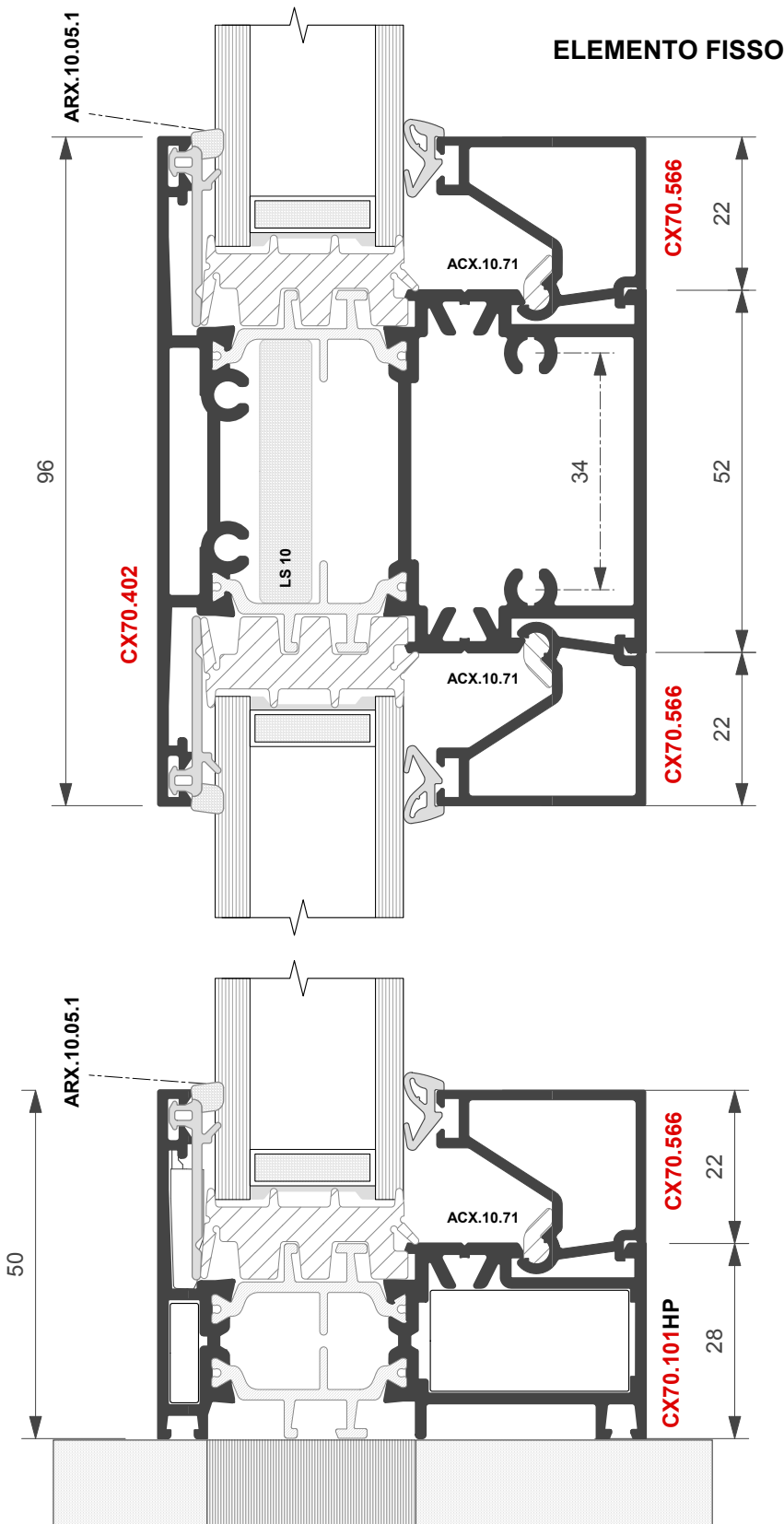



Ferramenta a nastro

FINESTRA A DUE ANTE

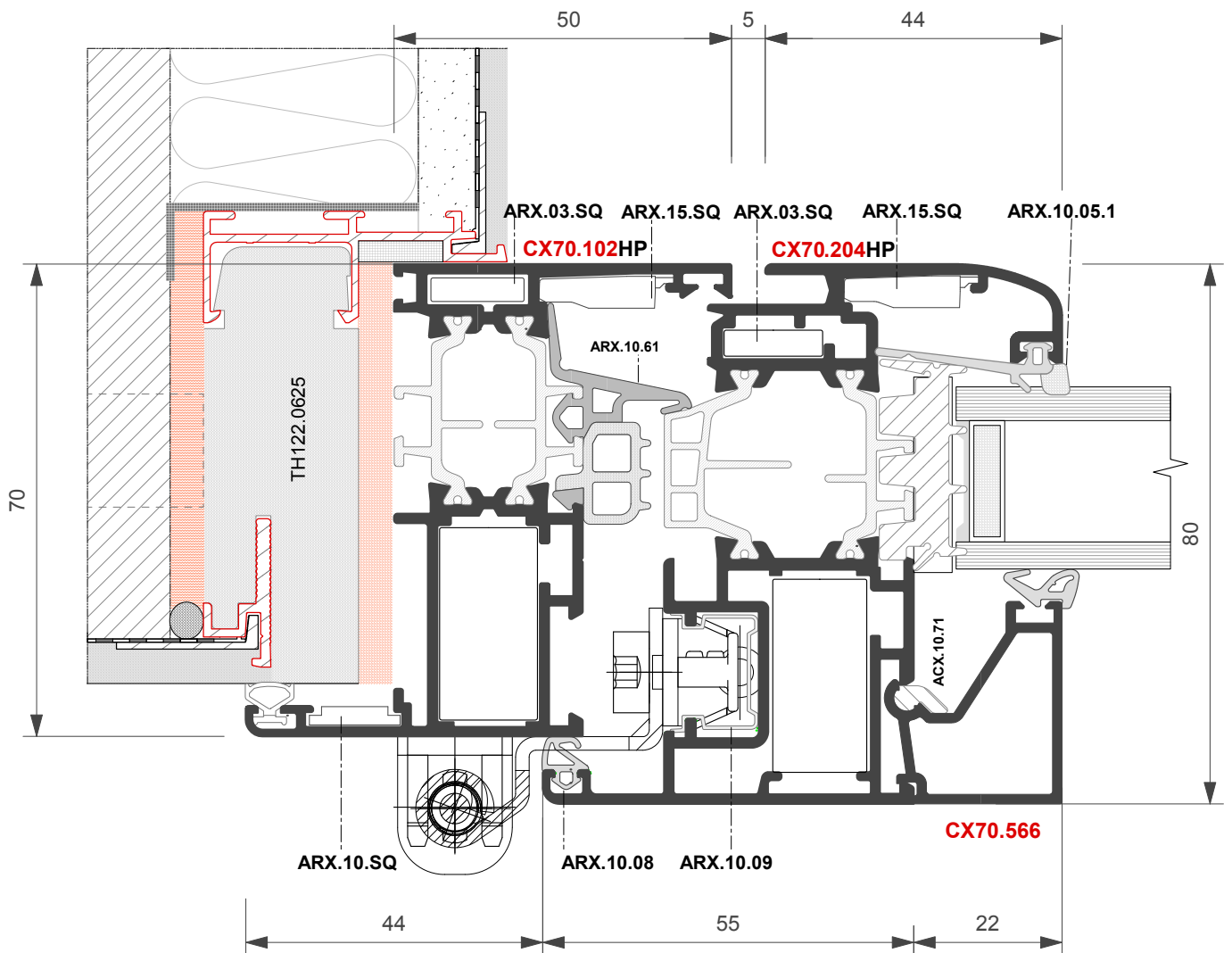
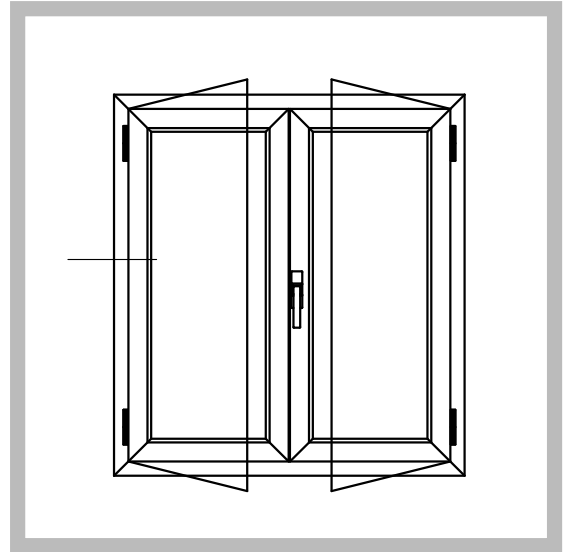



Ferramenta a nastro

FINESTRA A DUE ANTE

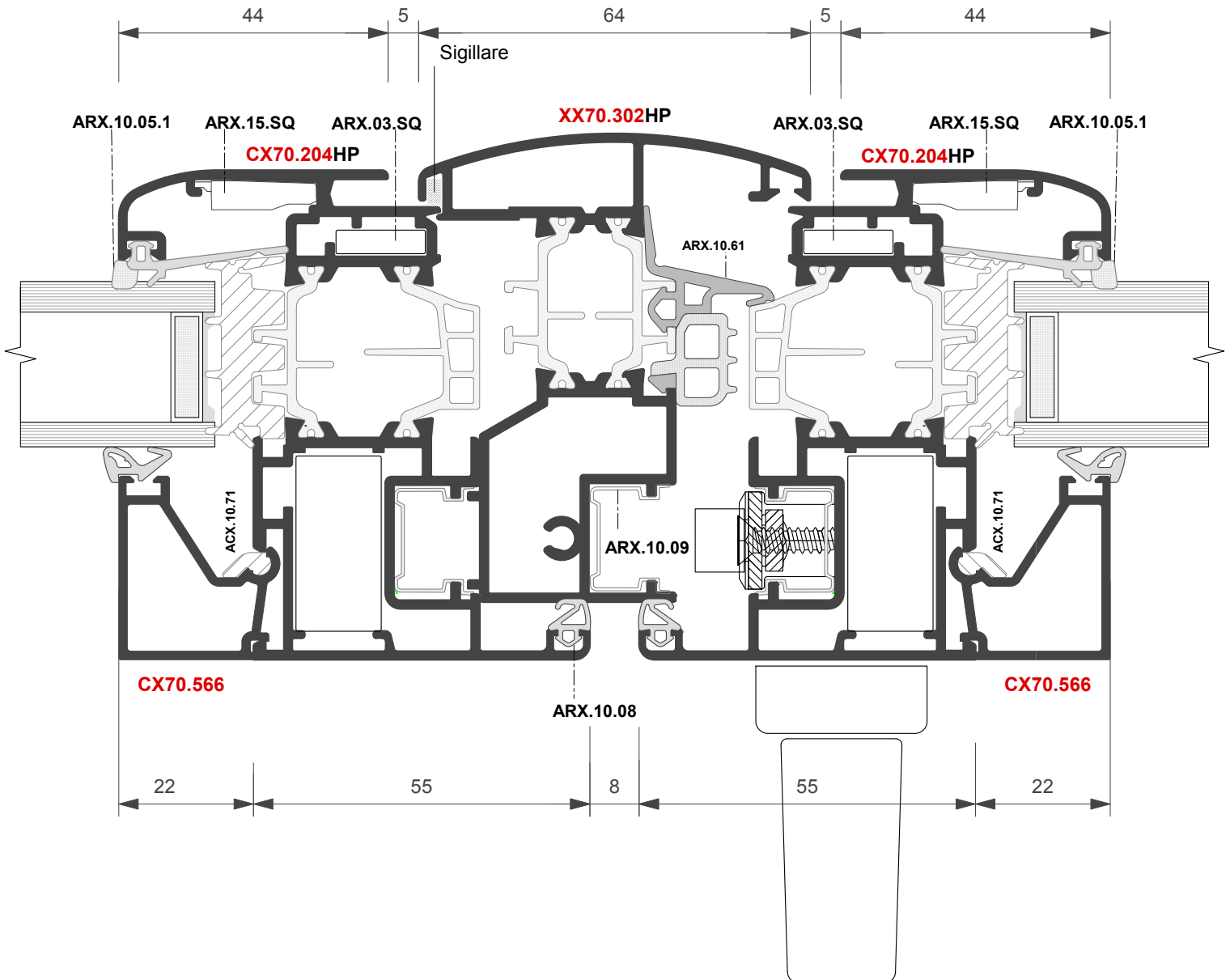
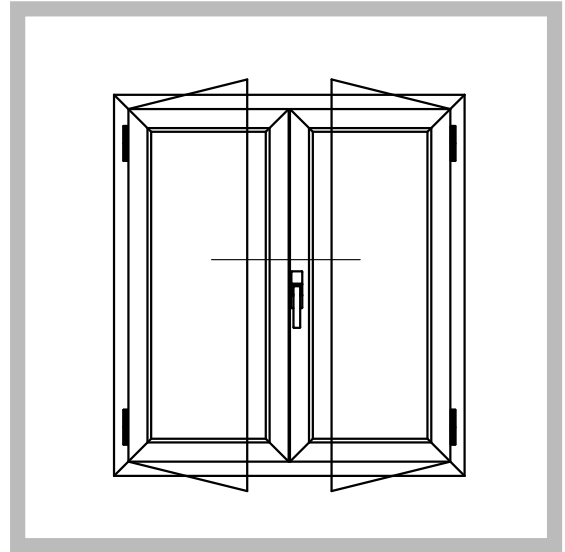



FINESTRA A DUE ANTE
Scorrevole in parallelo

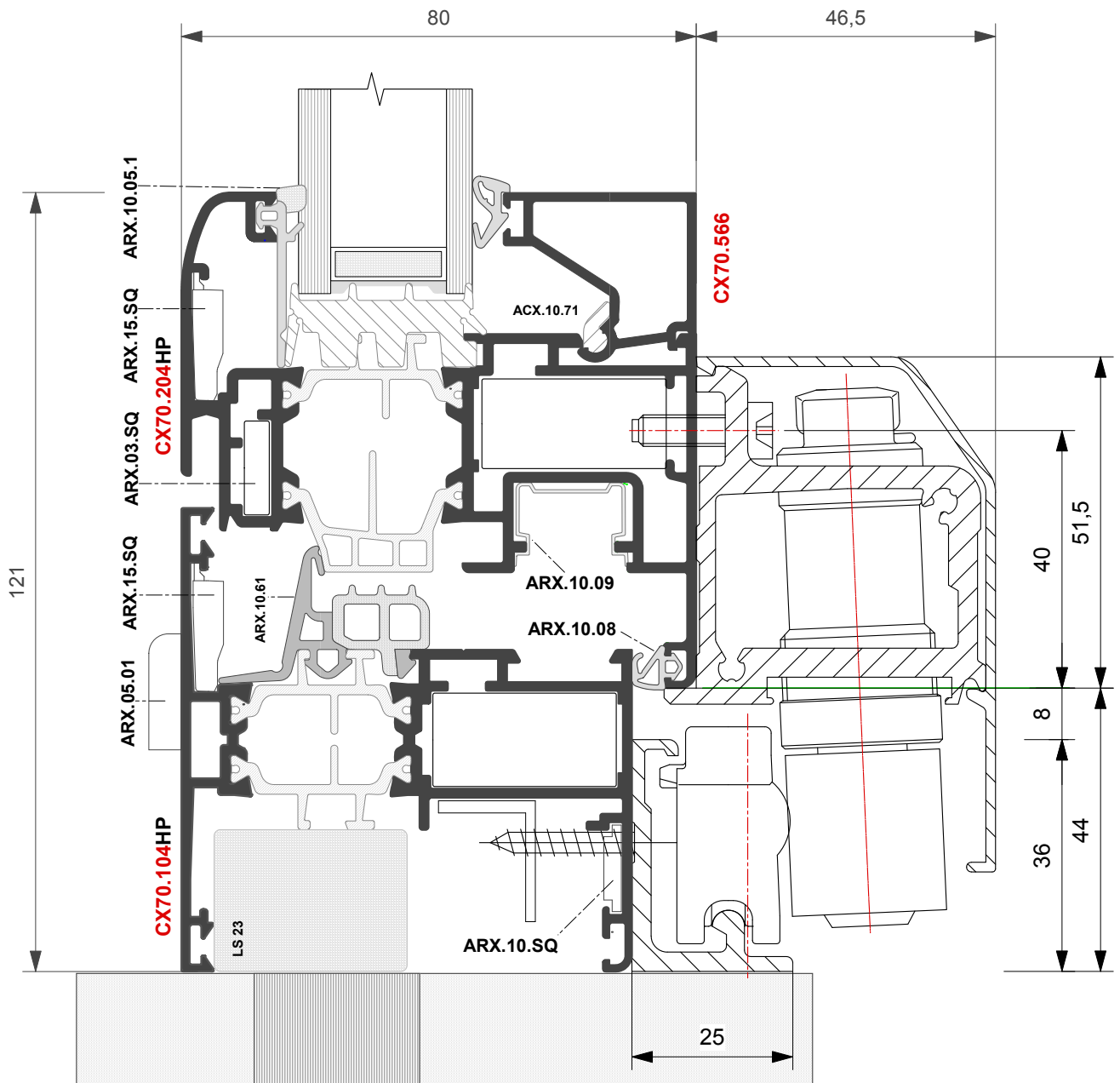
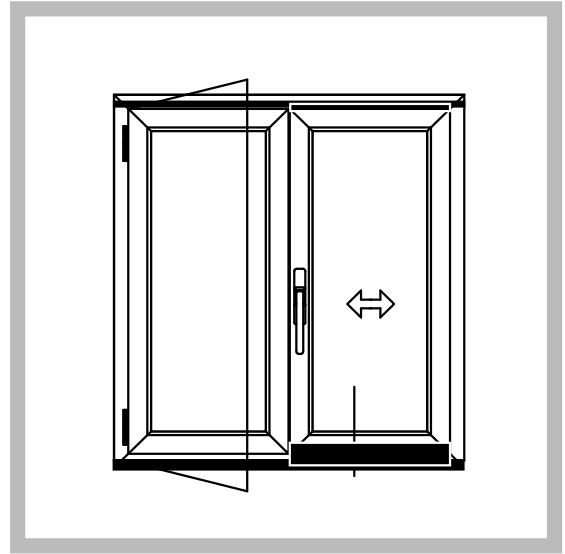



Ferramenta a nastro

FINESTRA A DUE ANTE
Scorrevole in parallelo

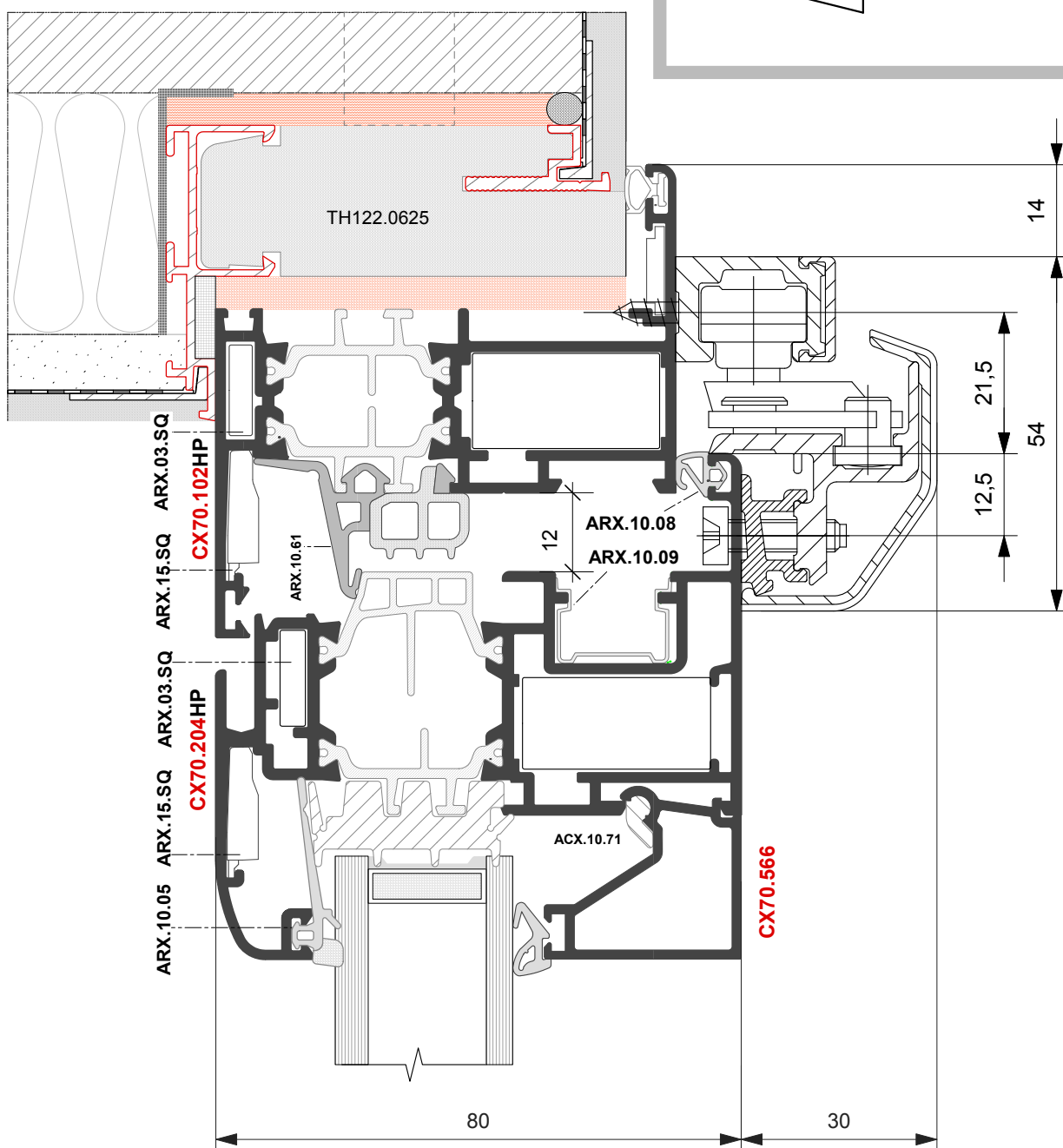
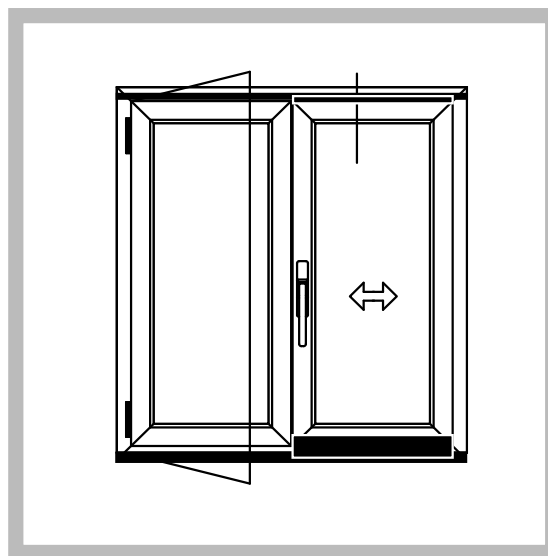



Ferramenta a nastro

PORTA BALCONE A DUE ANTE

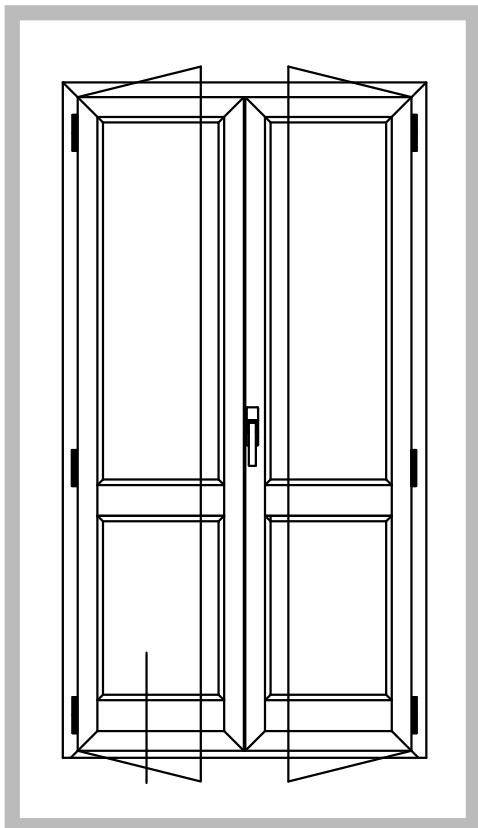
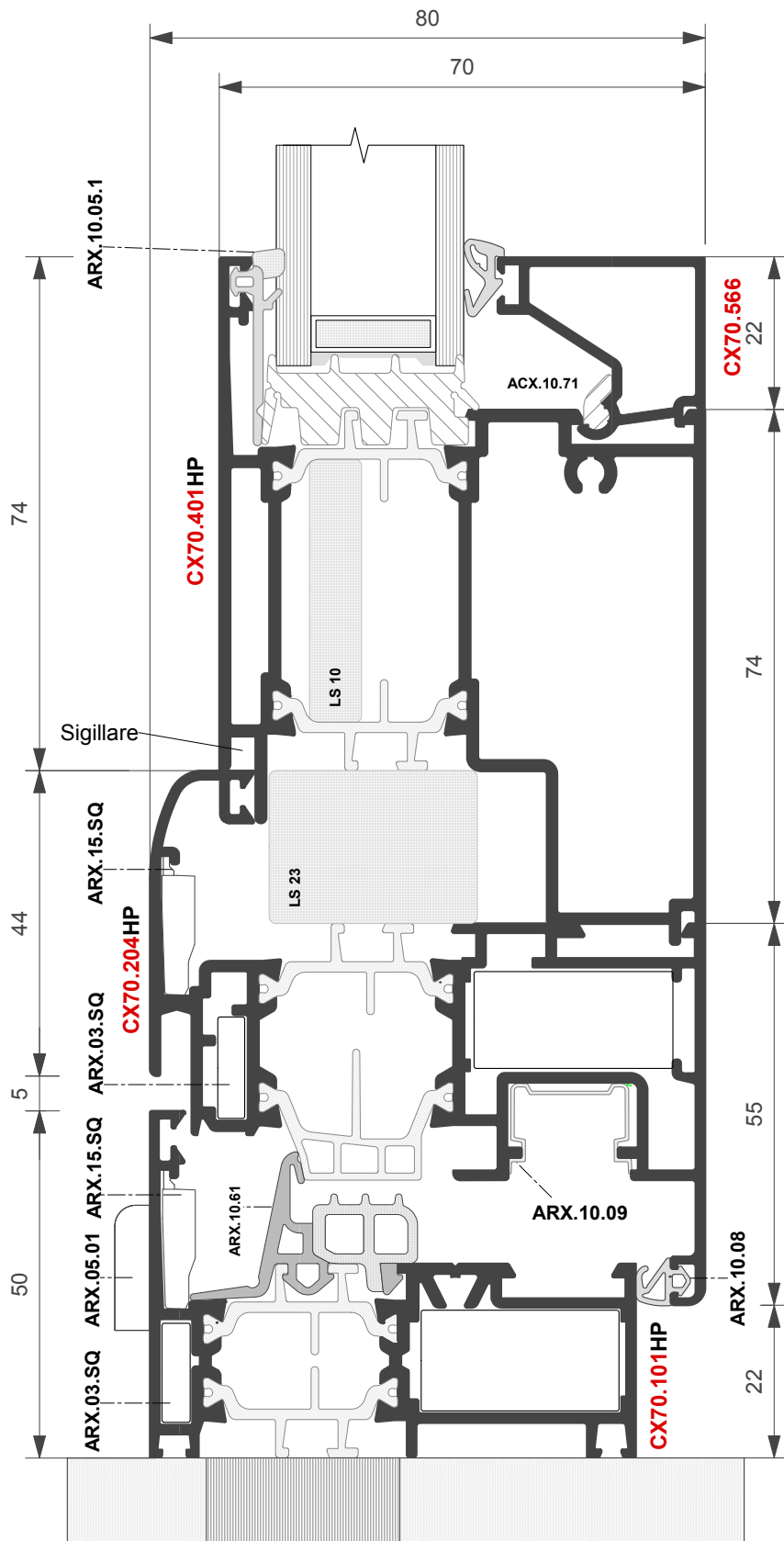



Ferramenta a nastro

PORTA BALCONE A DUE ANTE

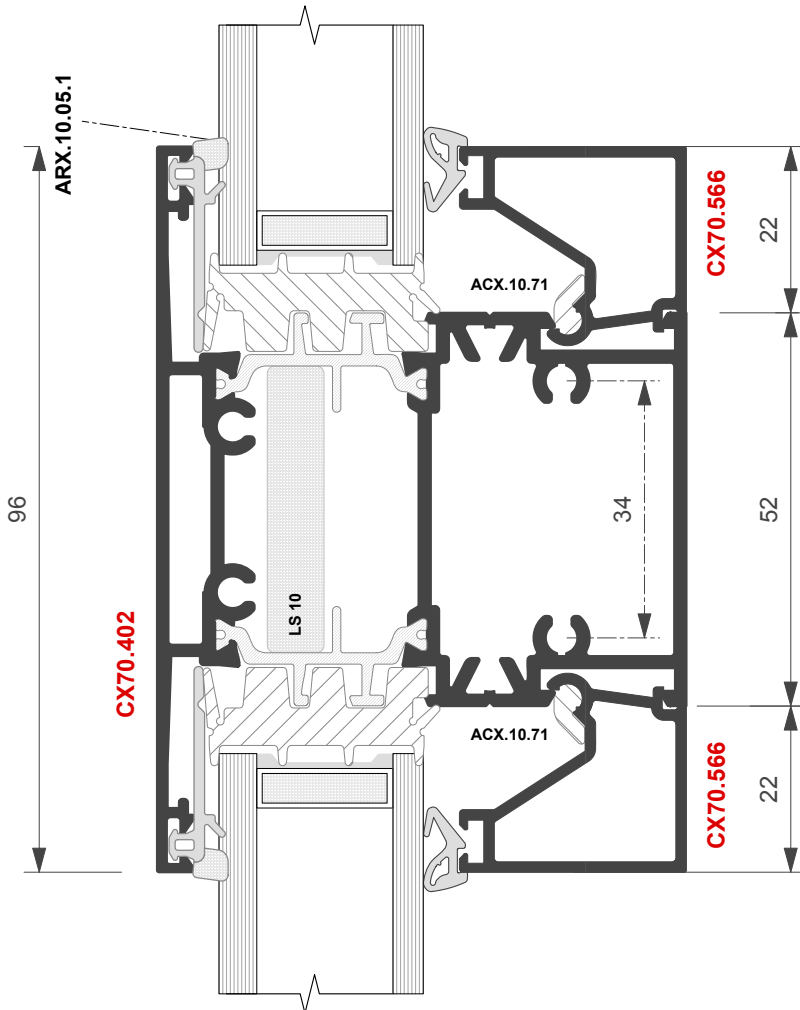
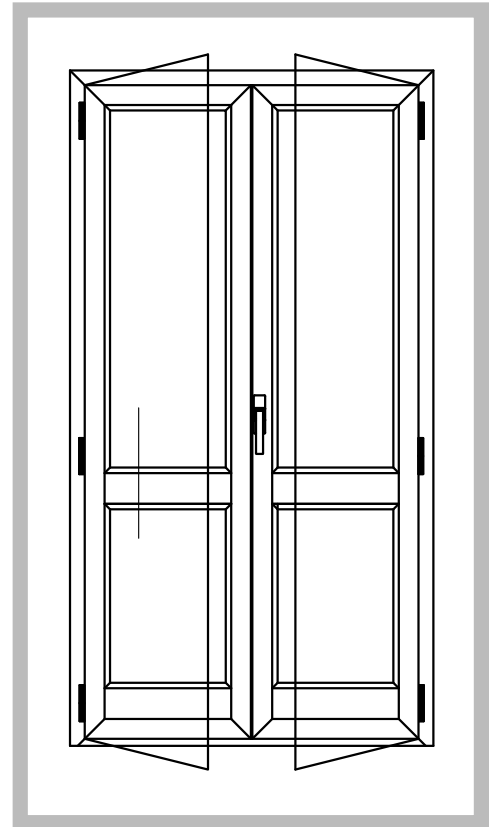



**FINESTRA
BILICO ORIZZONTALE**

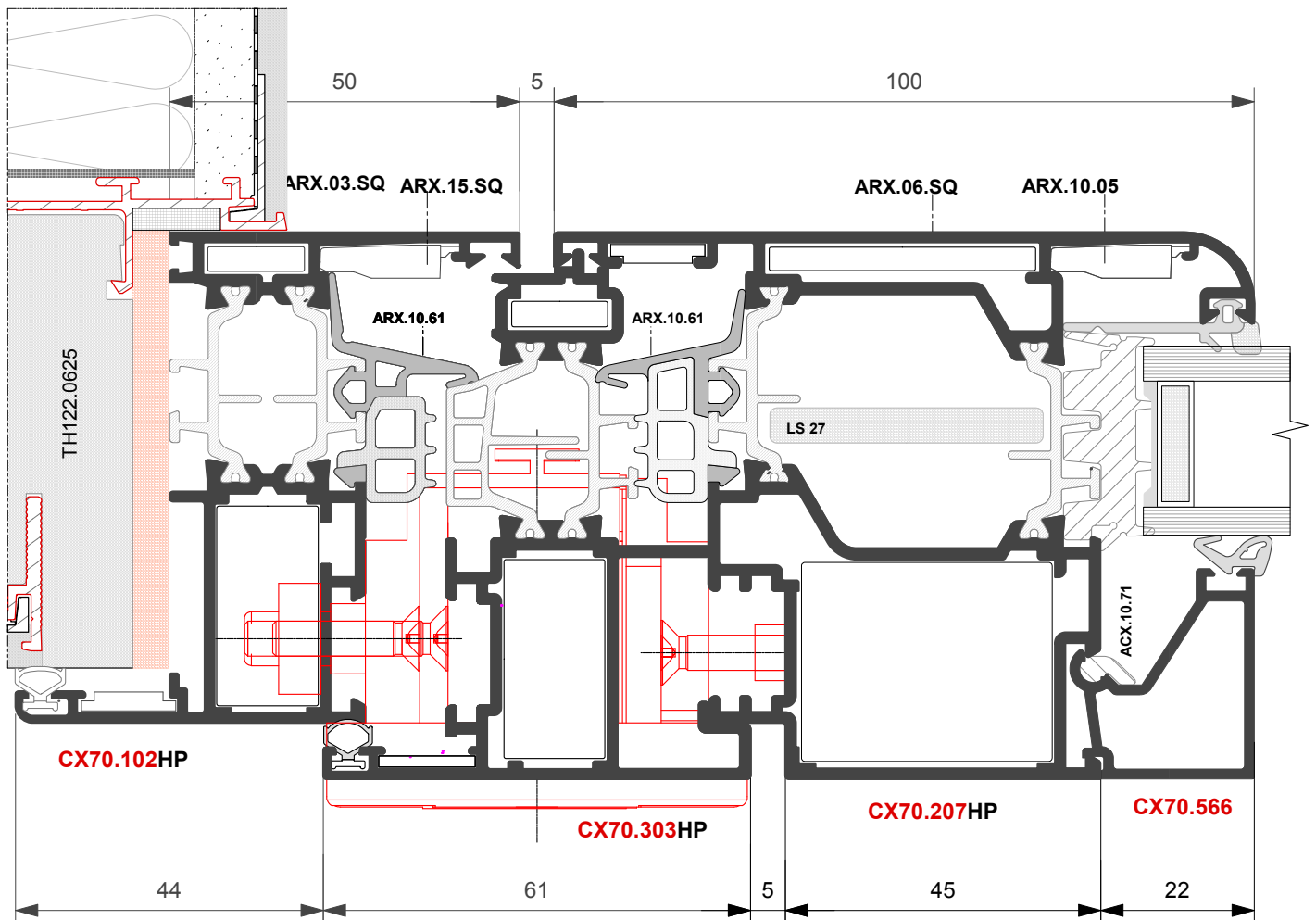
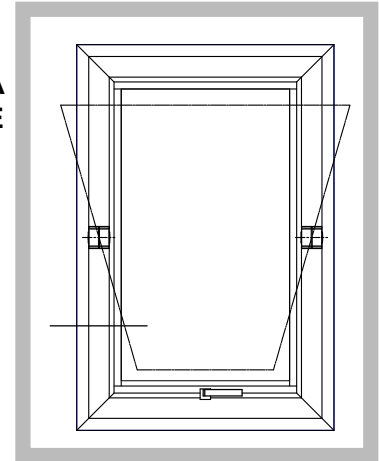

Accessorio Frizione **GU Italia U - 18/3**
Articolo 6 - 27212 - 07 - P
 per accessori di movimentazione riferirsi
 alla tavola di assieme



ABBINAMENTO CON SCORREVOLE SX 700

Telaio in appoggio

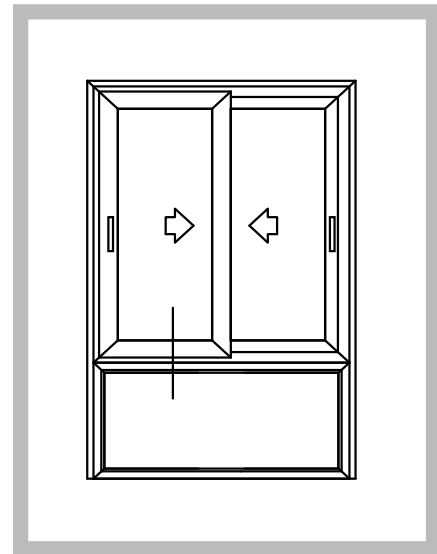
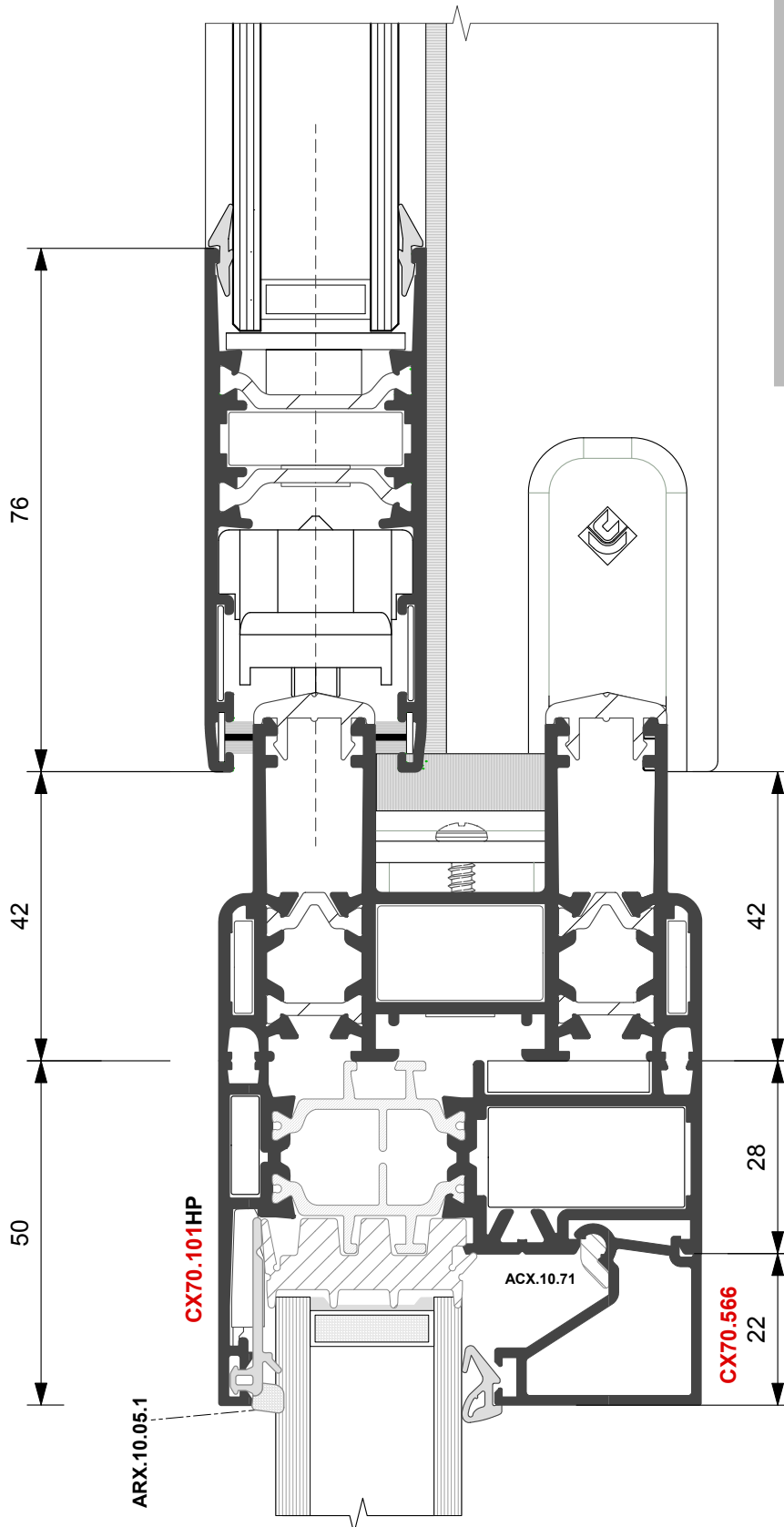

Per i riferimenti della serie SX 700 consultare il relativo catalogo.



TELAIO CAPANNONI

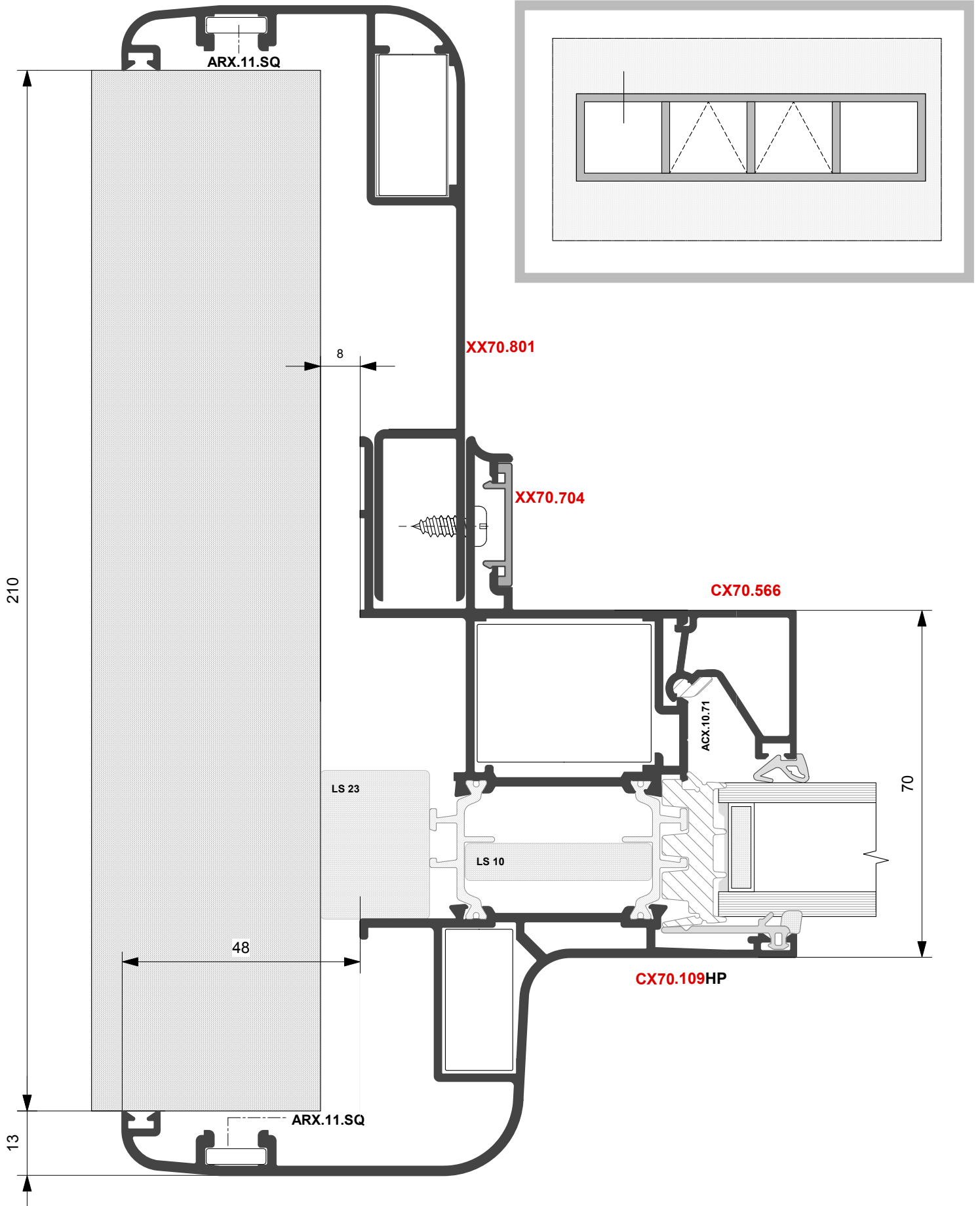



TELAIO CAPANNONI

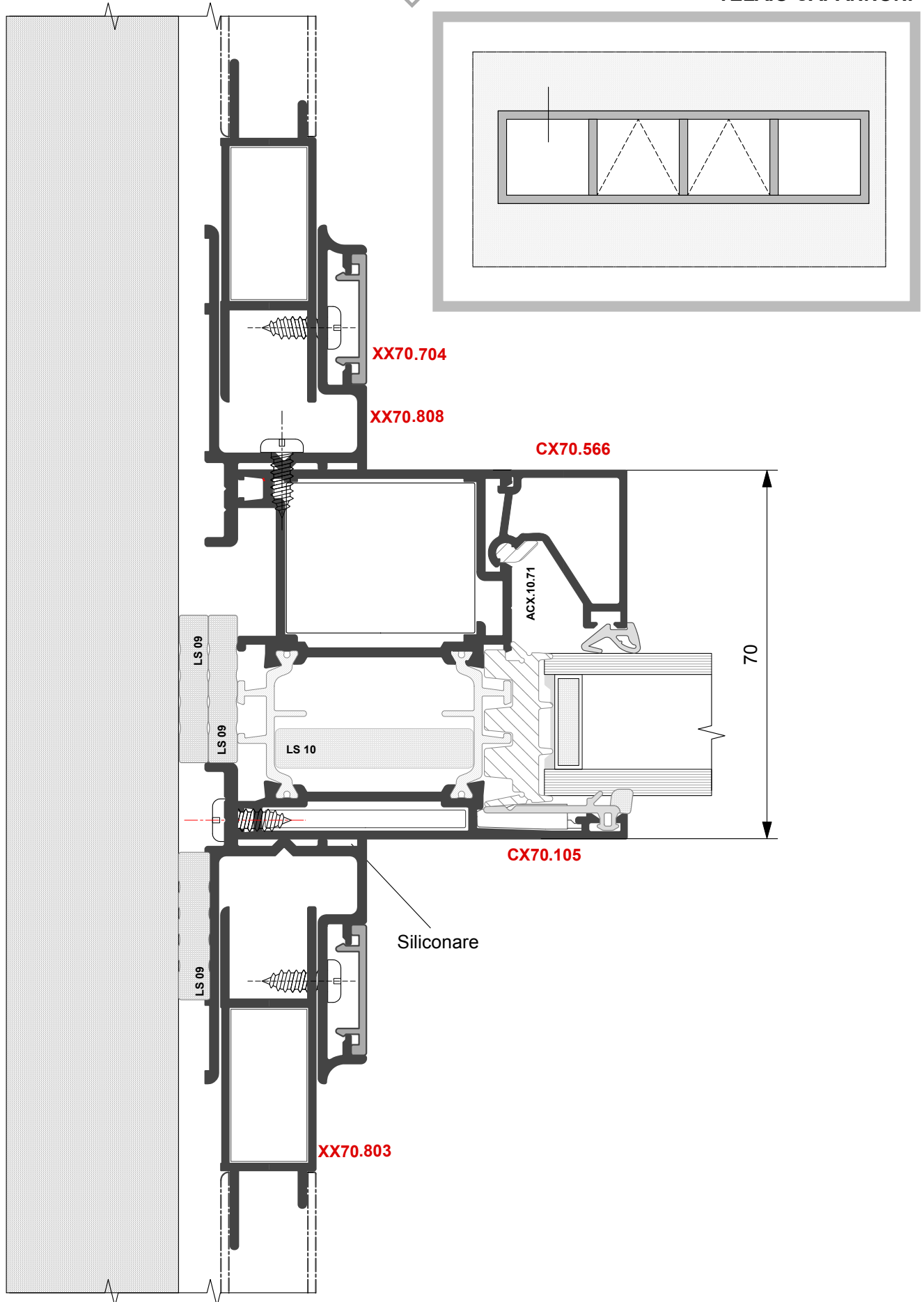



TELAI COMPENSAZIONE

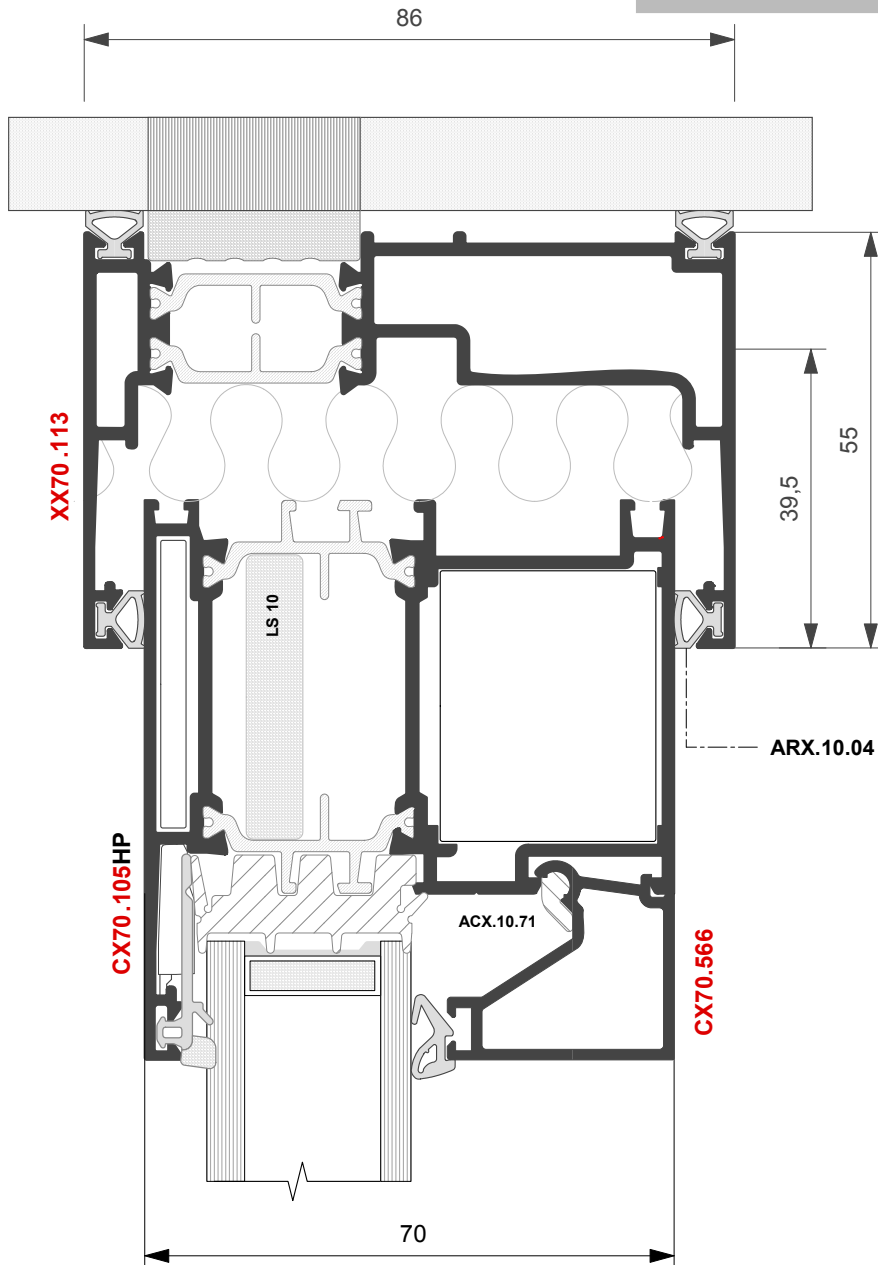
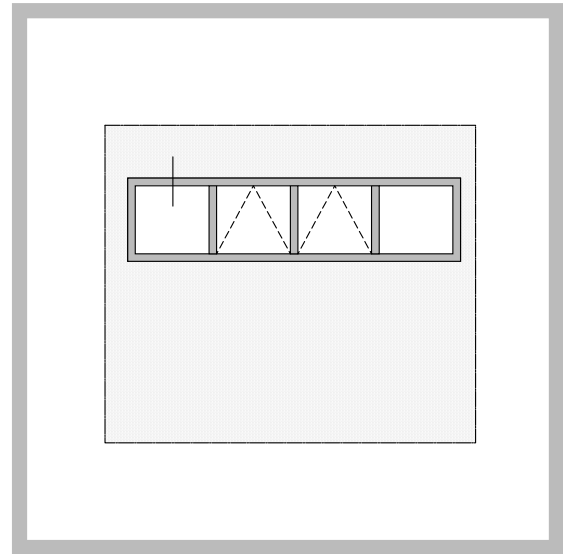



PROFILO UNIVERSALE PER ANGOLO A 90°

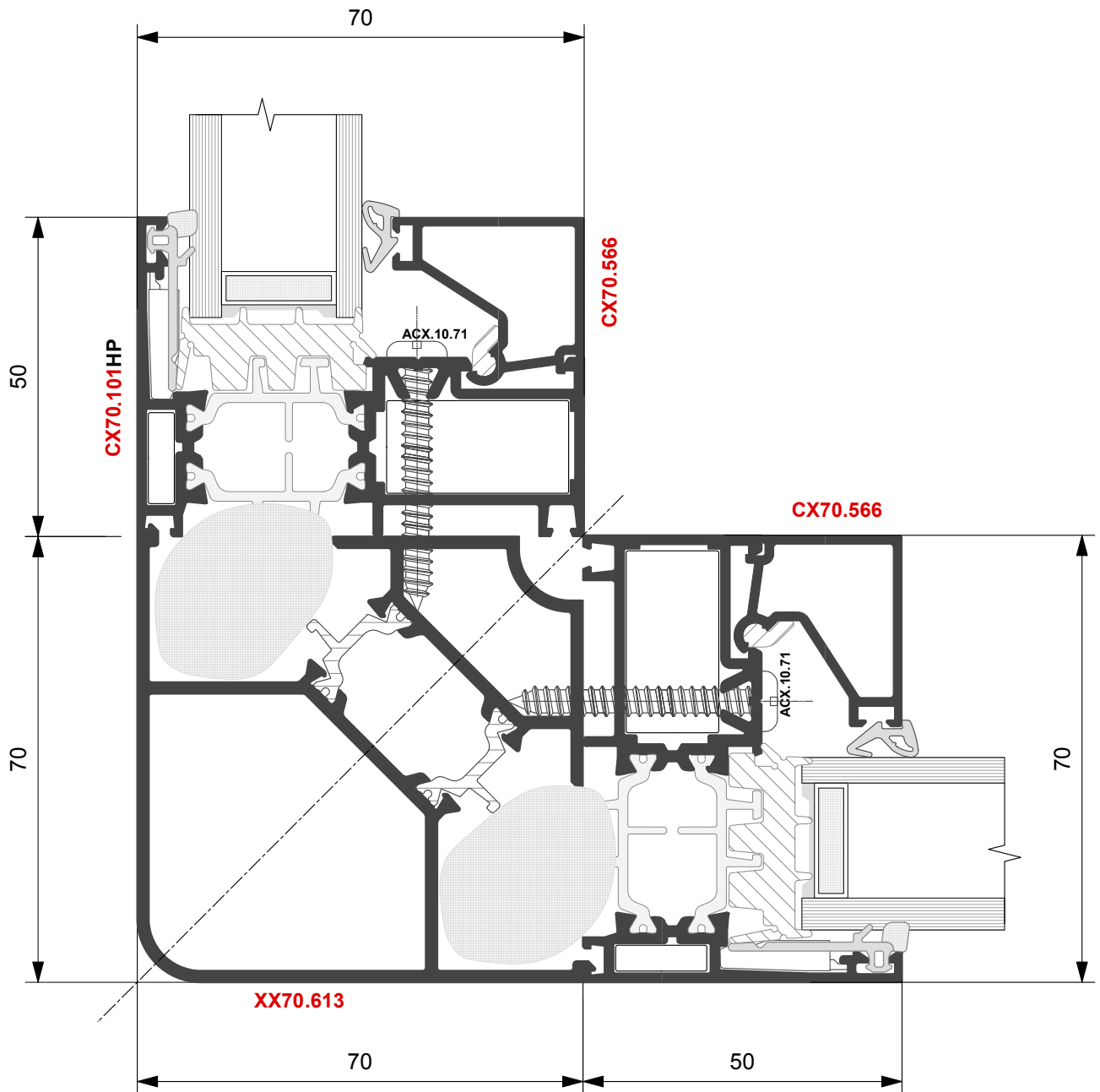



PORTA DI INGRESSO A 2 ANTE

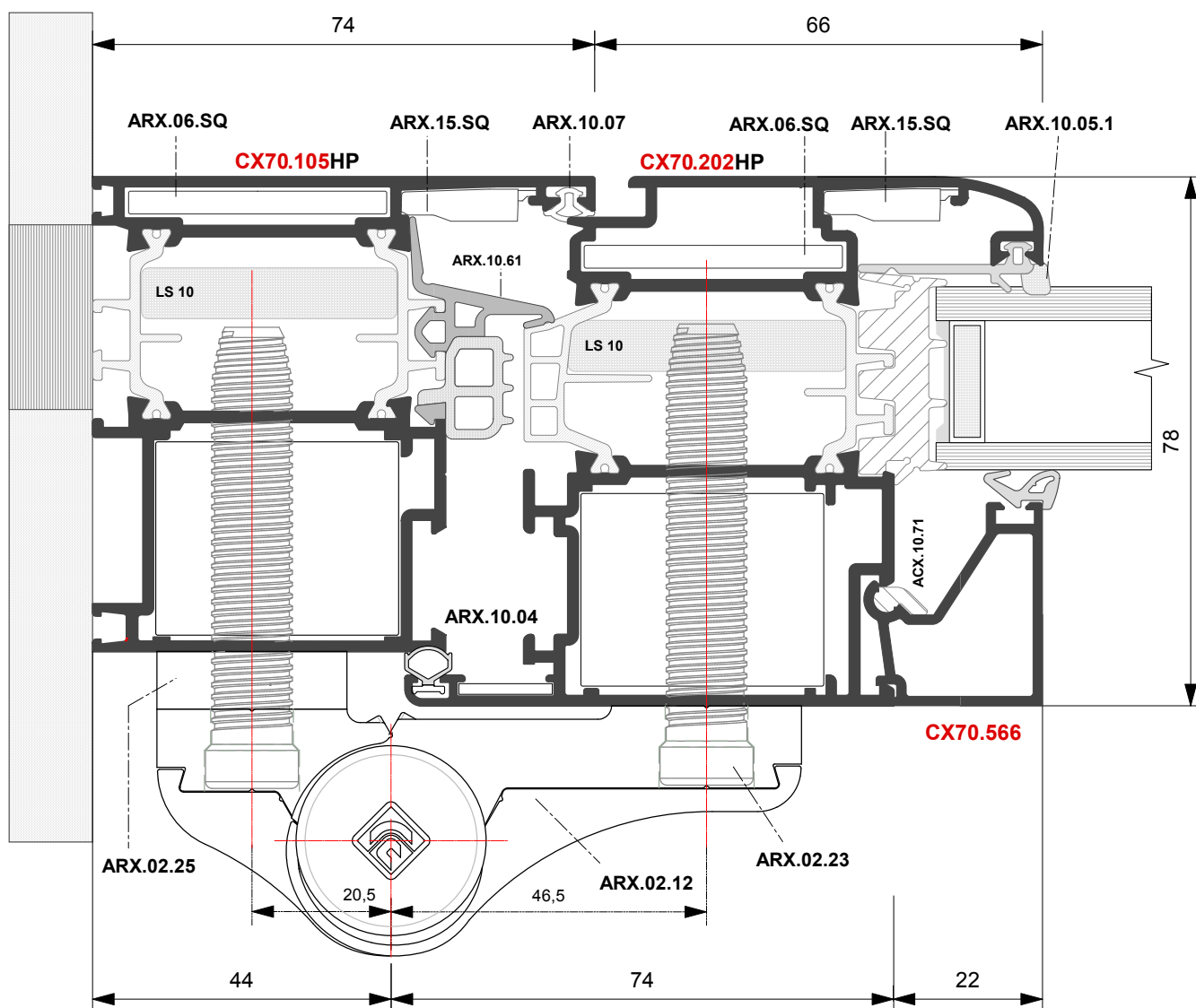
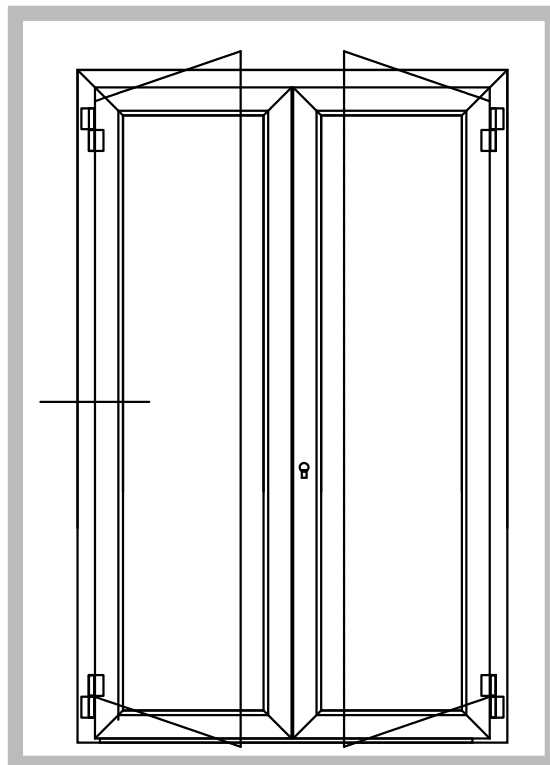



PORTA DI INGRESSO A 2 ANTE

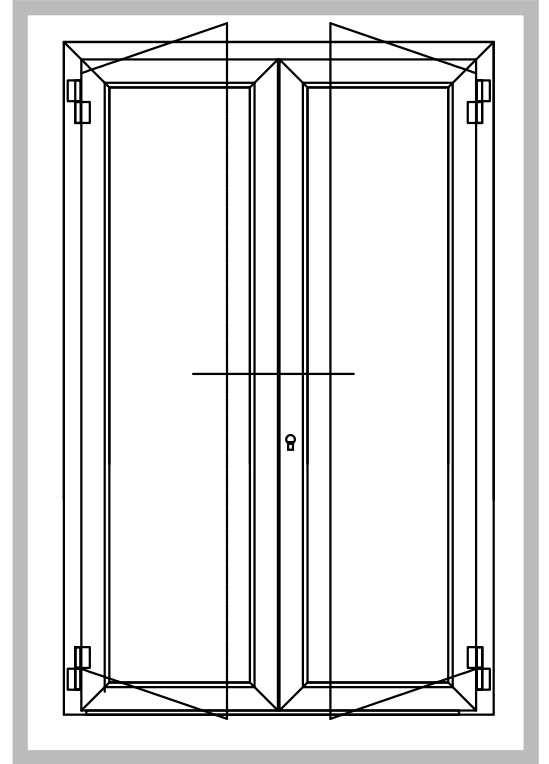
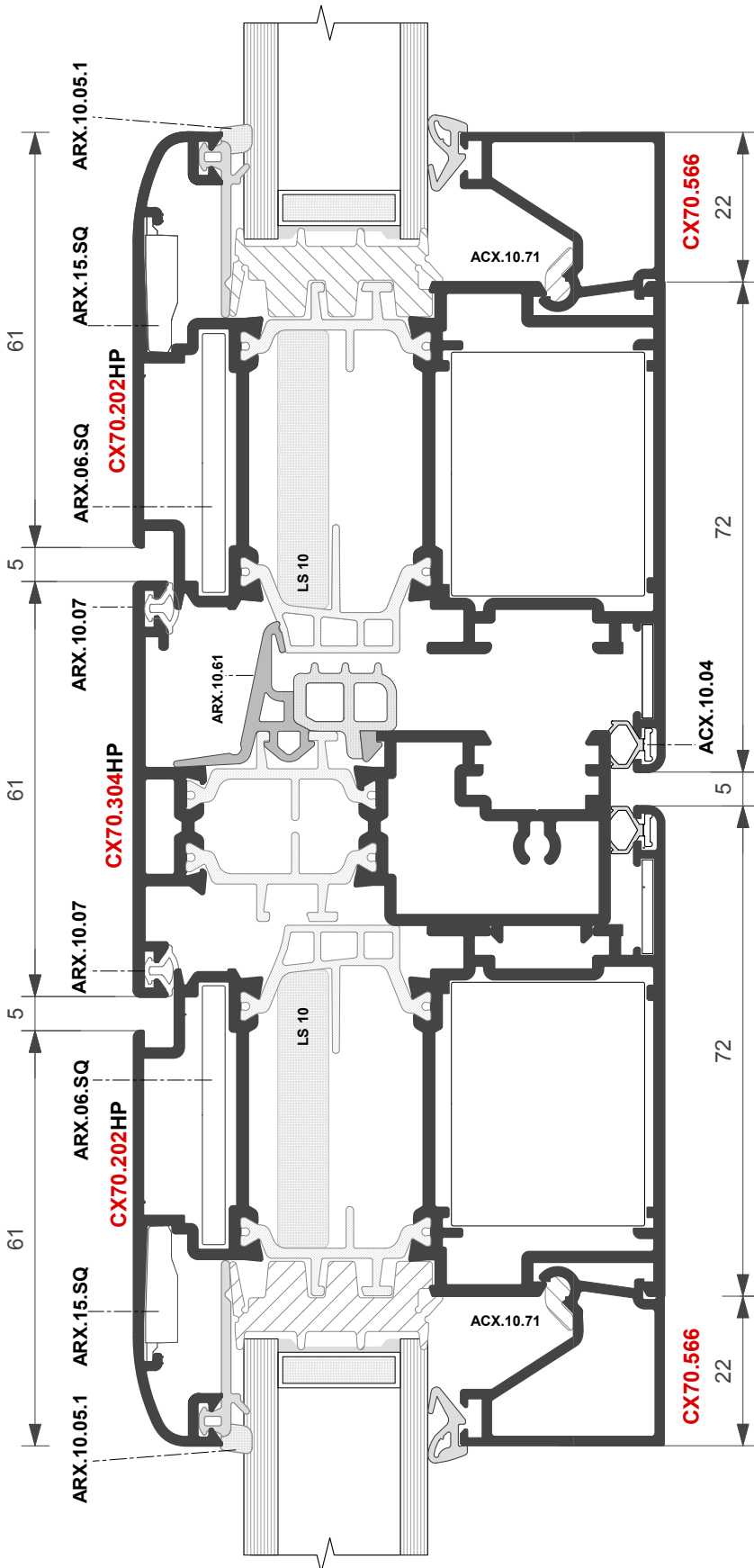



PORTA INGRESSO AD UNA ANTA

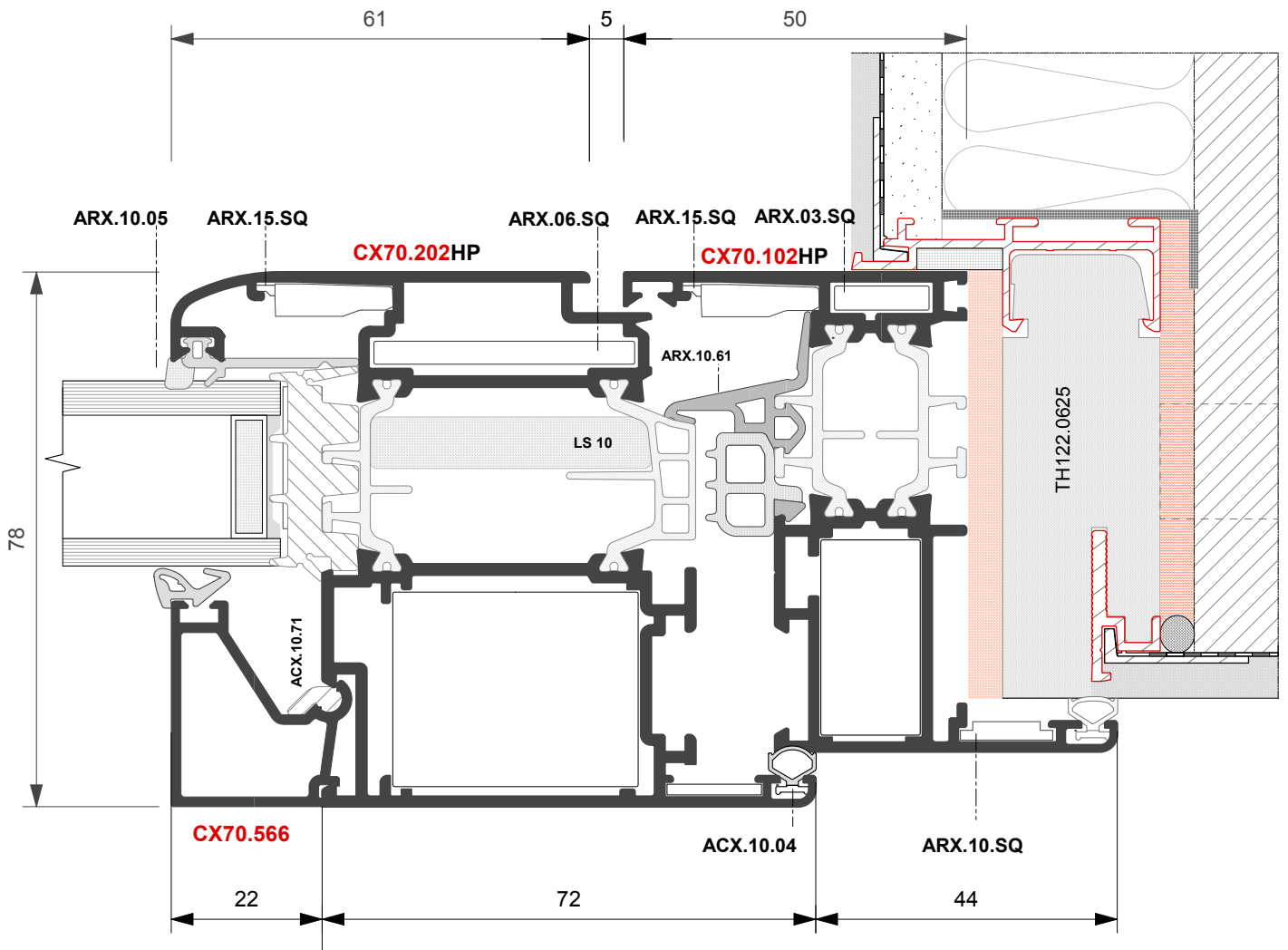
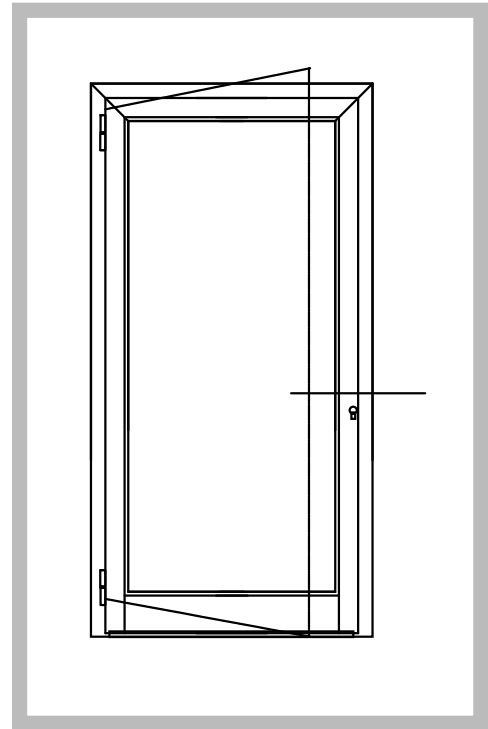



PORTA DI INGRESSO A 2 ANTE

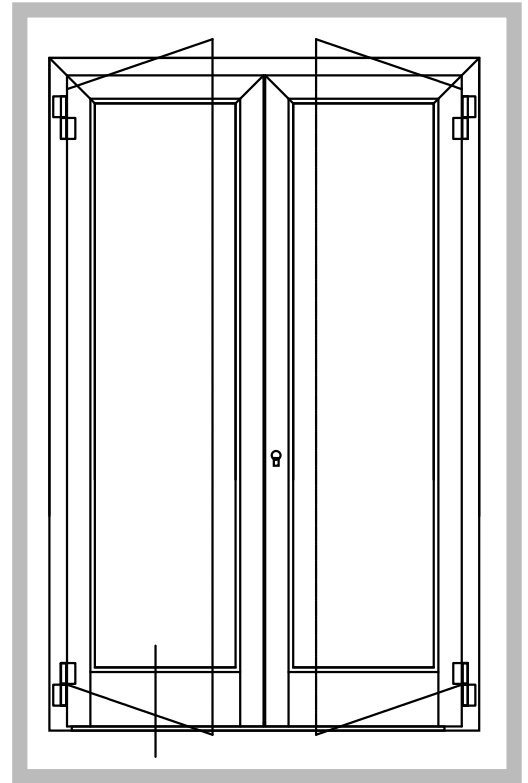
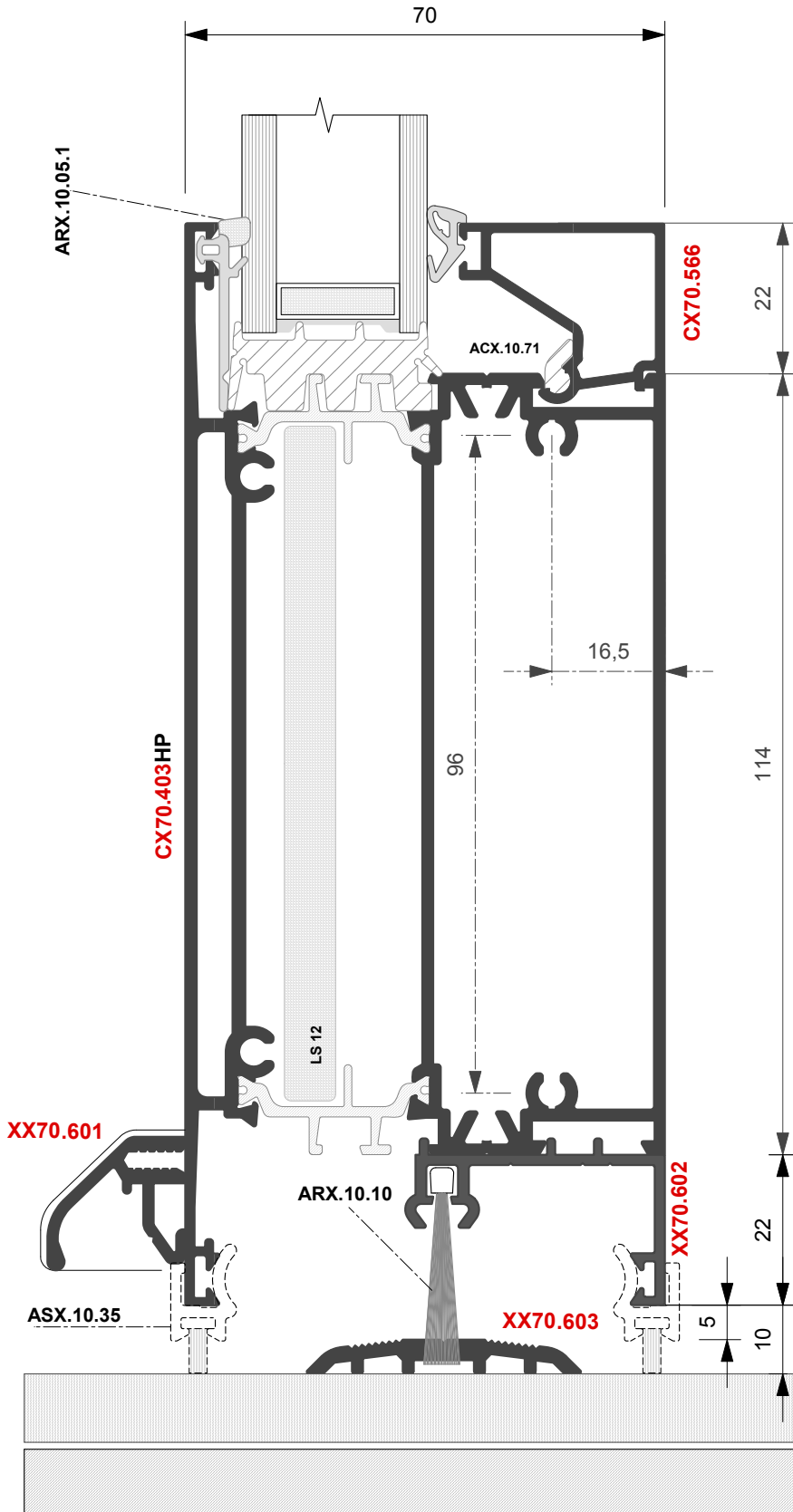



PORTA DI INGRESSO A 2 ANTE

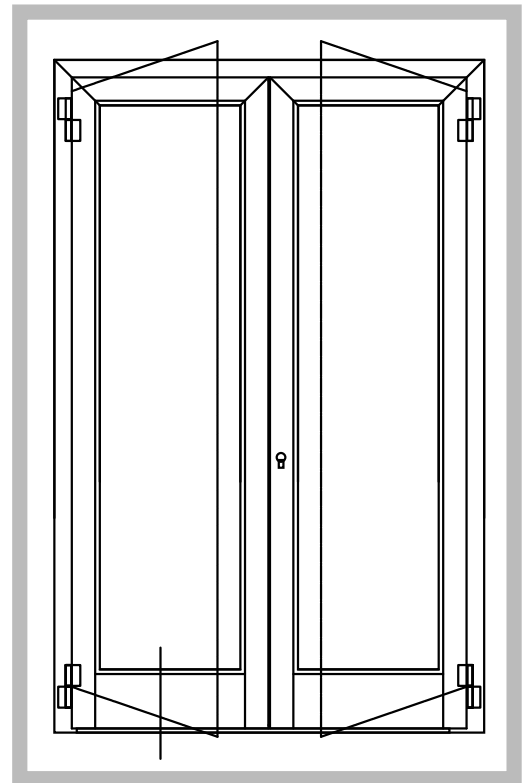
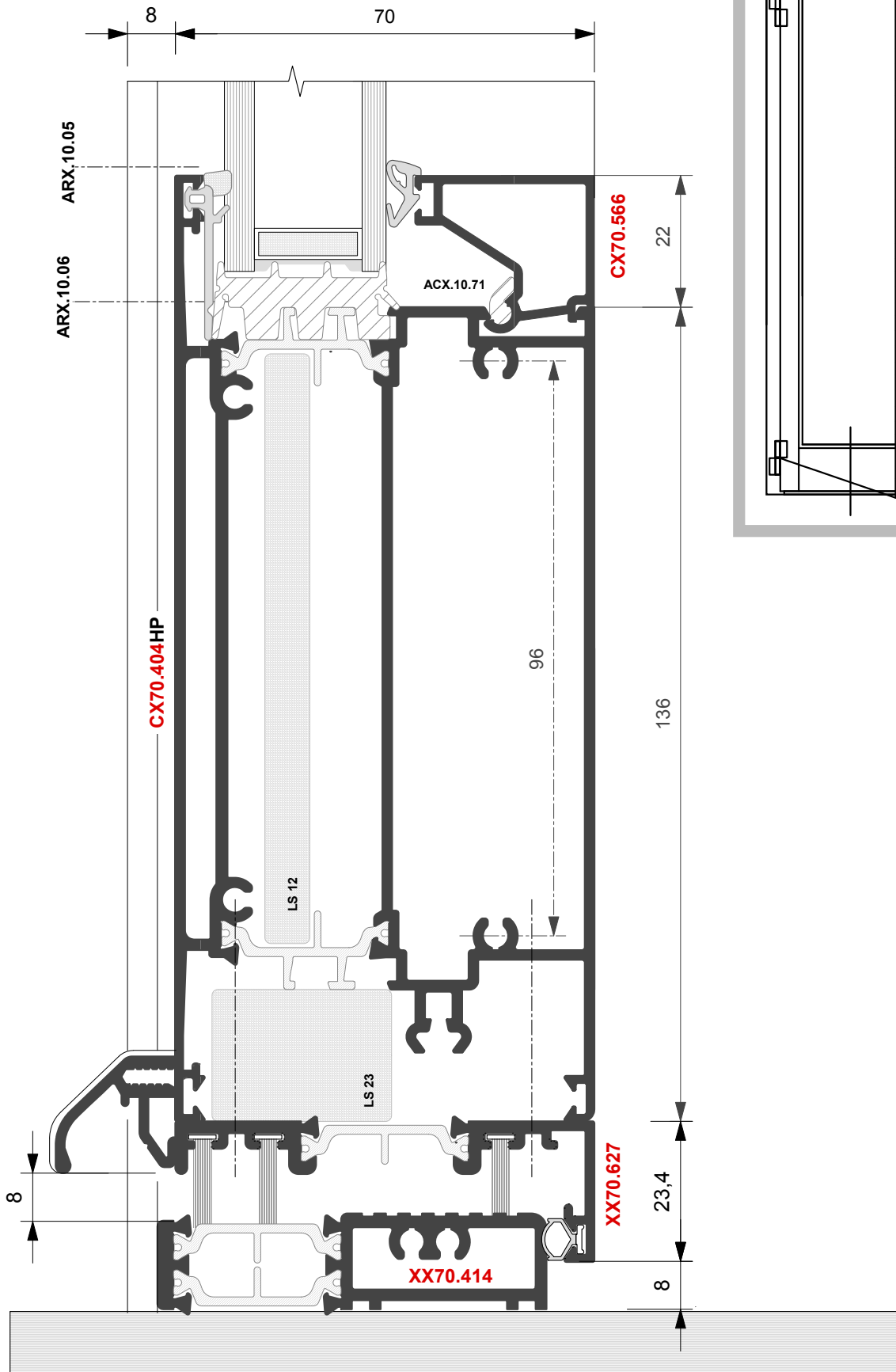

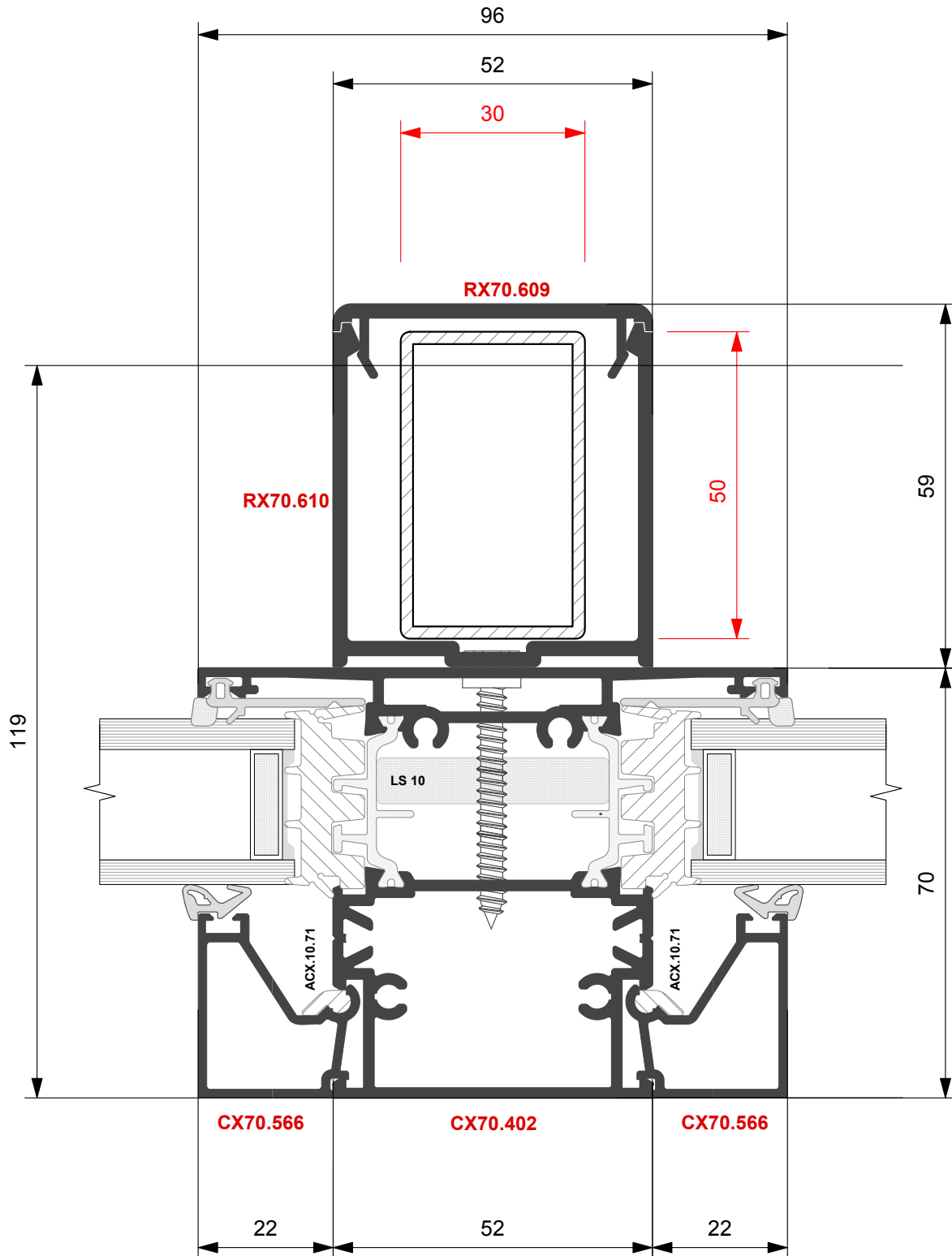

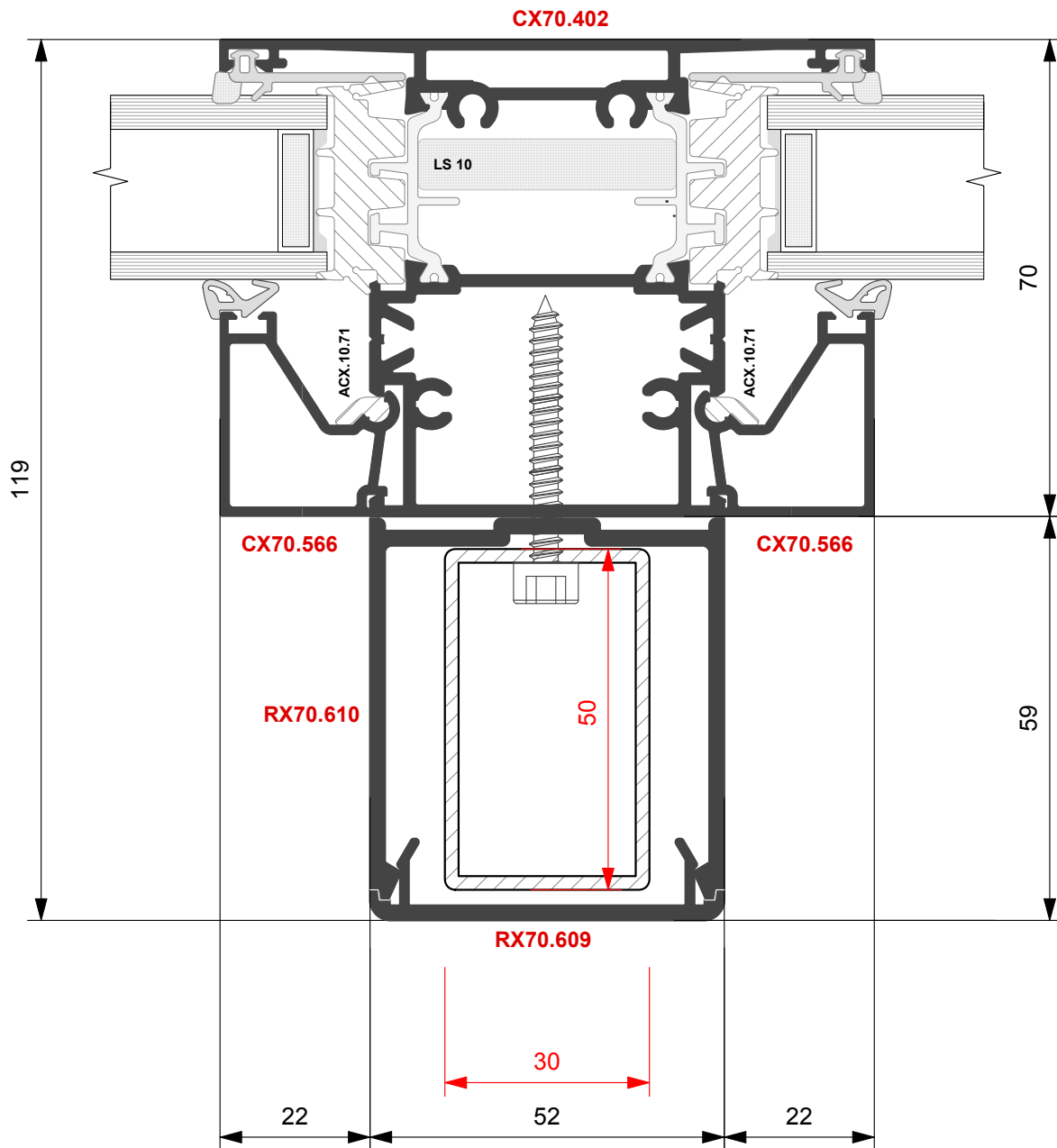

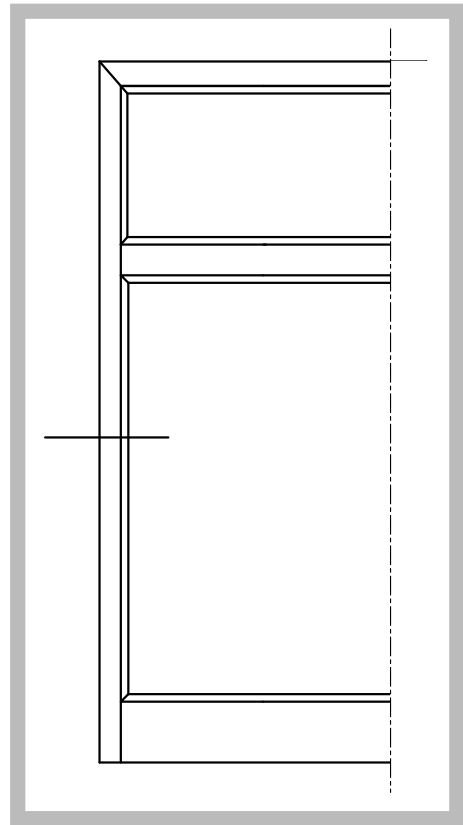
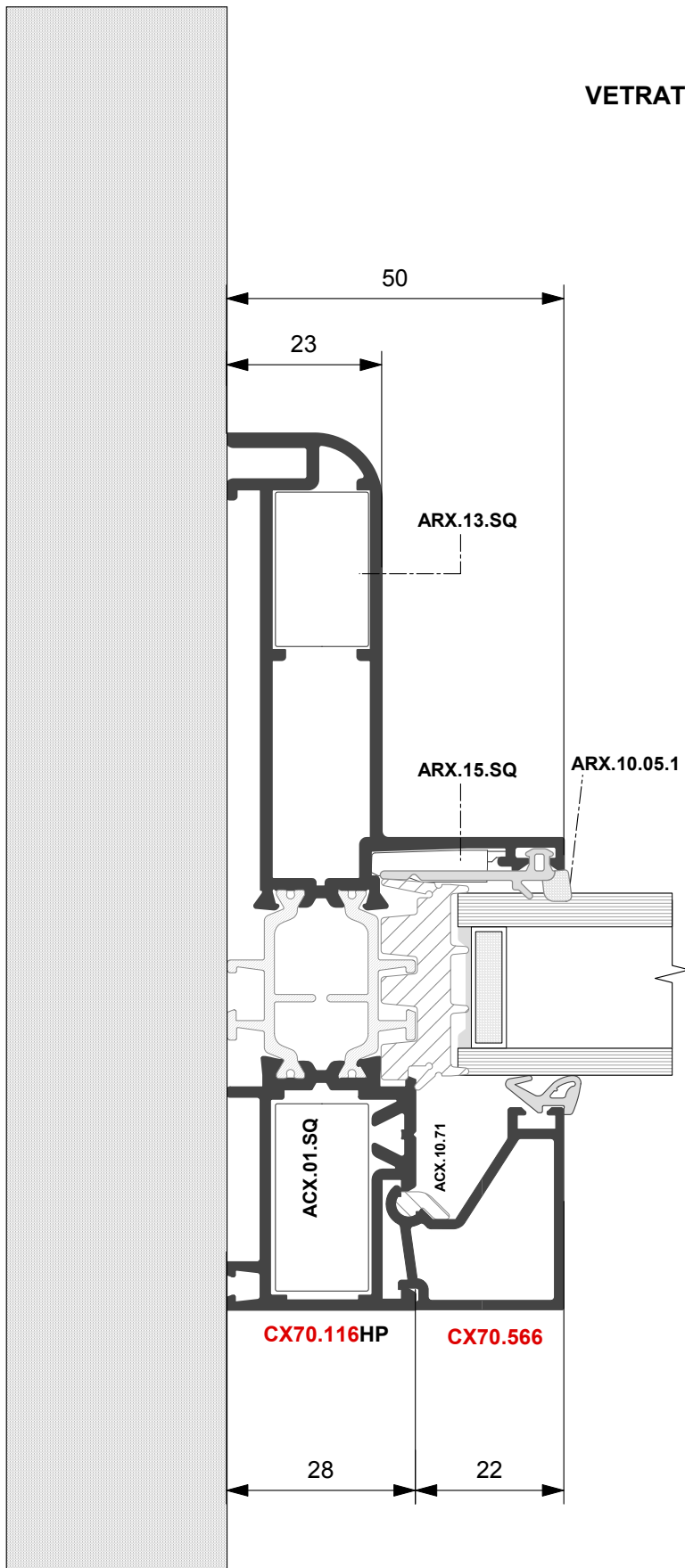



VETRATE

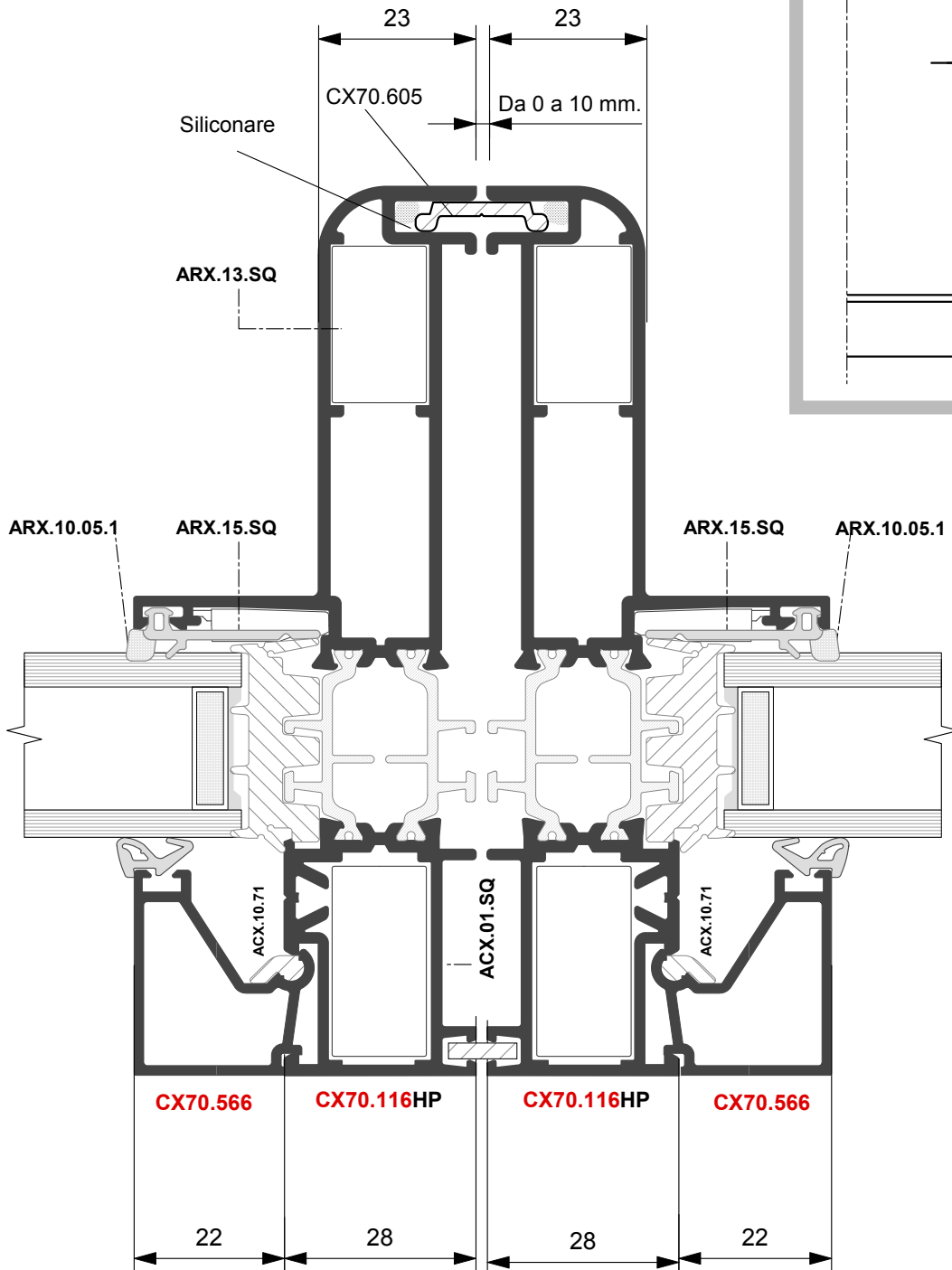
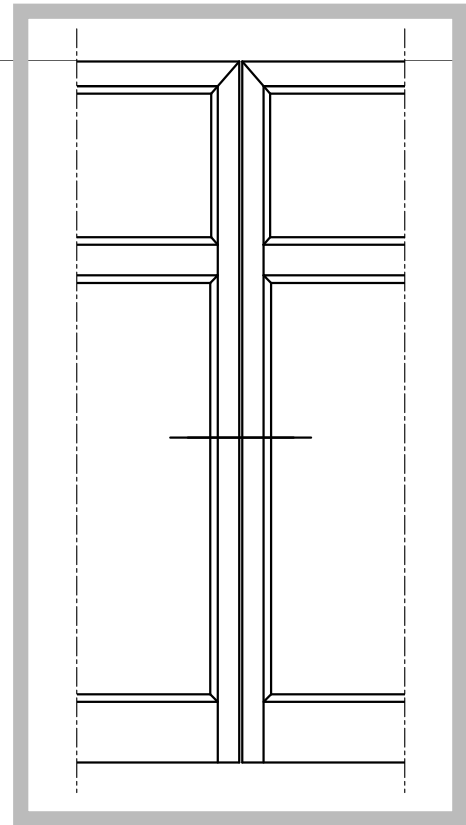



PORTA DI INGRESSO A 2 ANTE
Apertura esterna

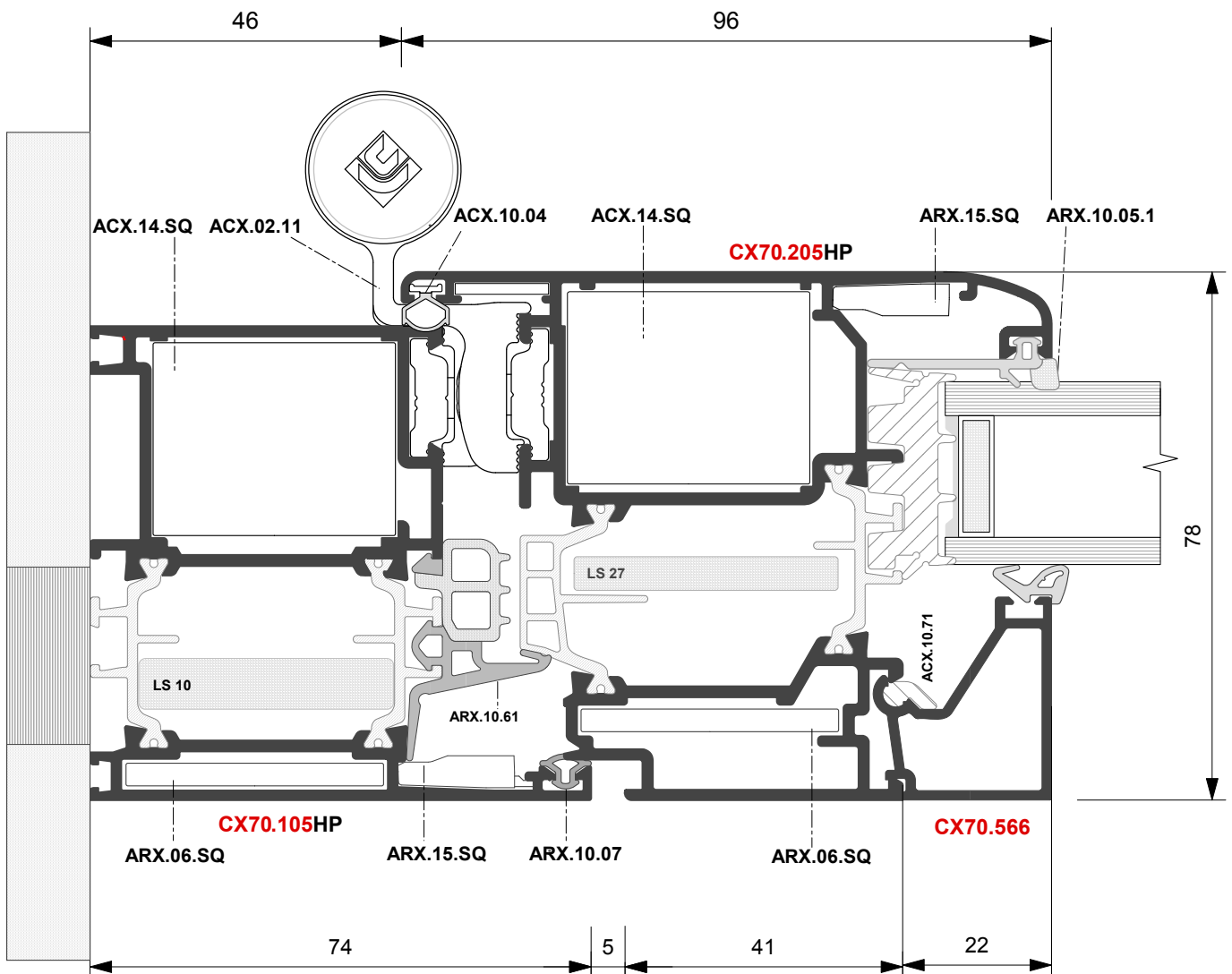
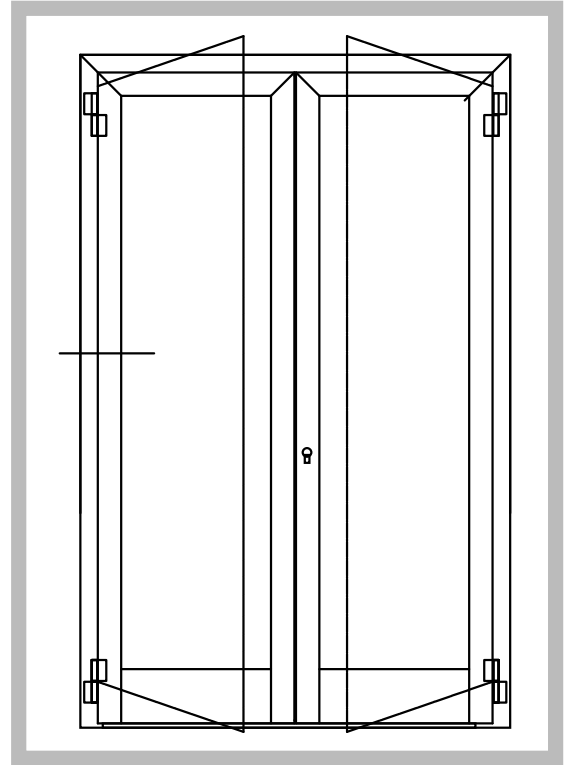



PORTA DI INGRESSO A 2 ANTE
Apertura esterna

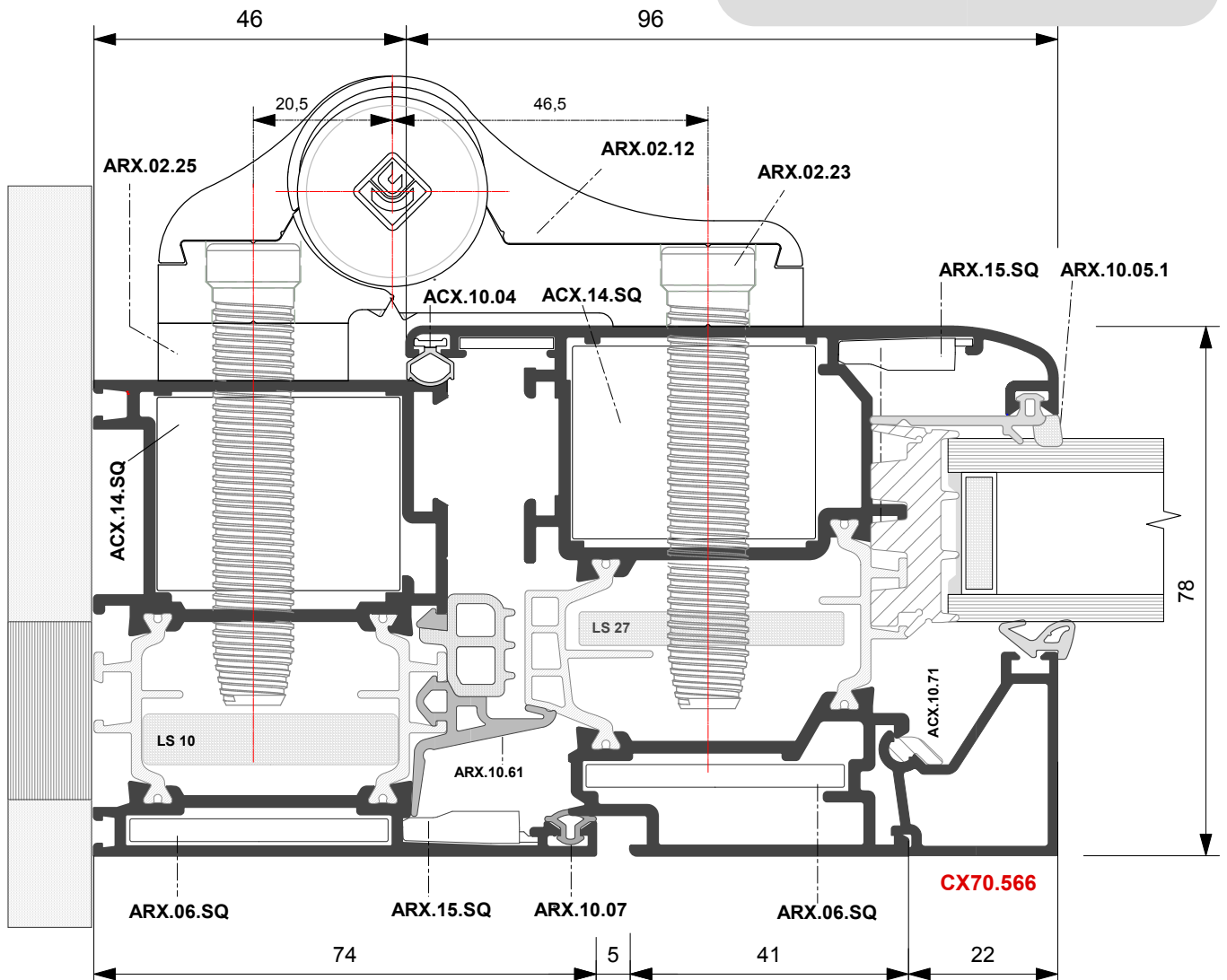
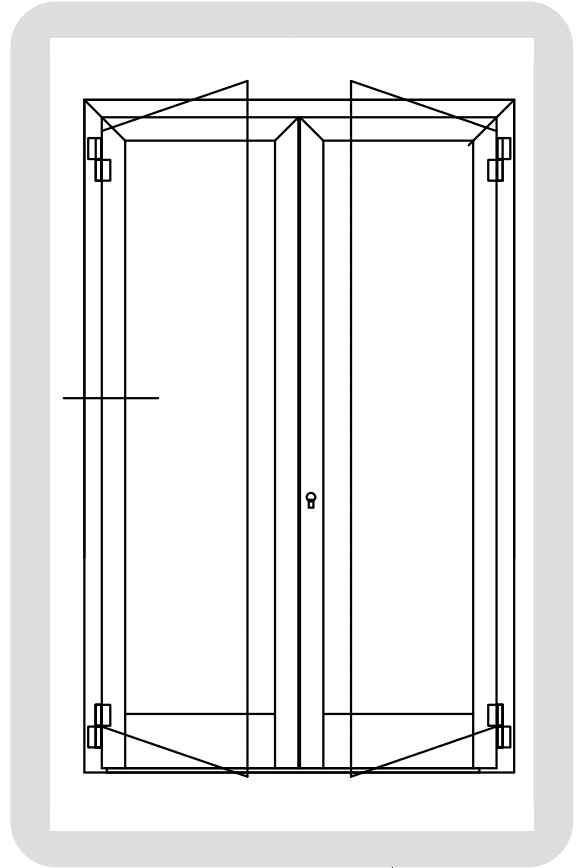



PORTA INGRESSO AD UNA ANTA
Apertura esterna

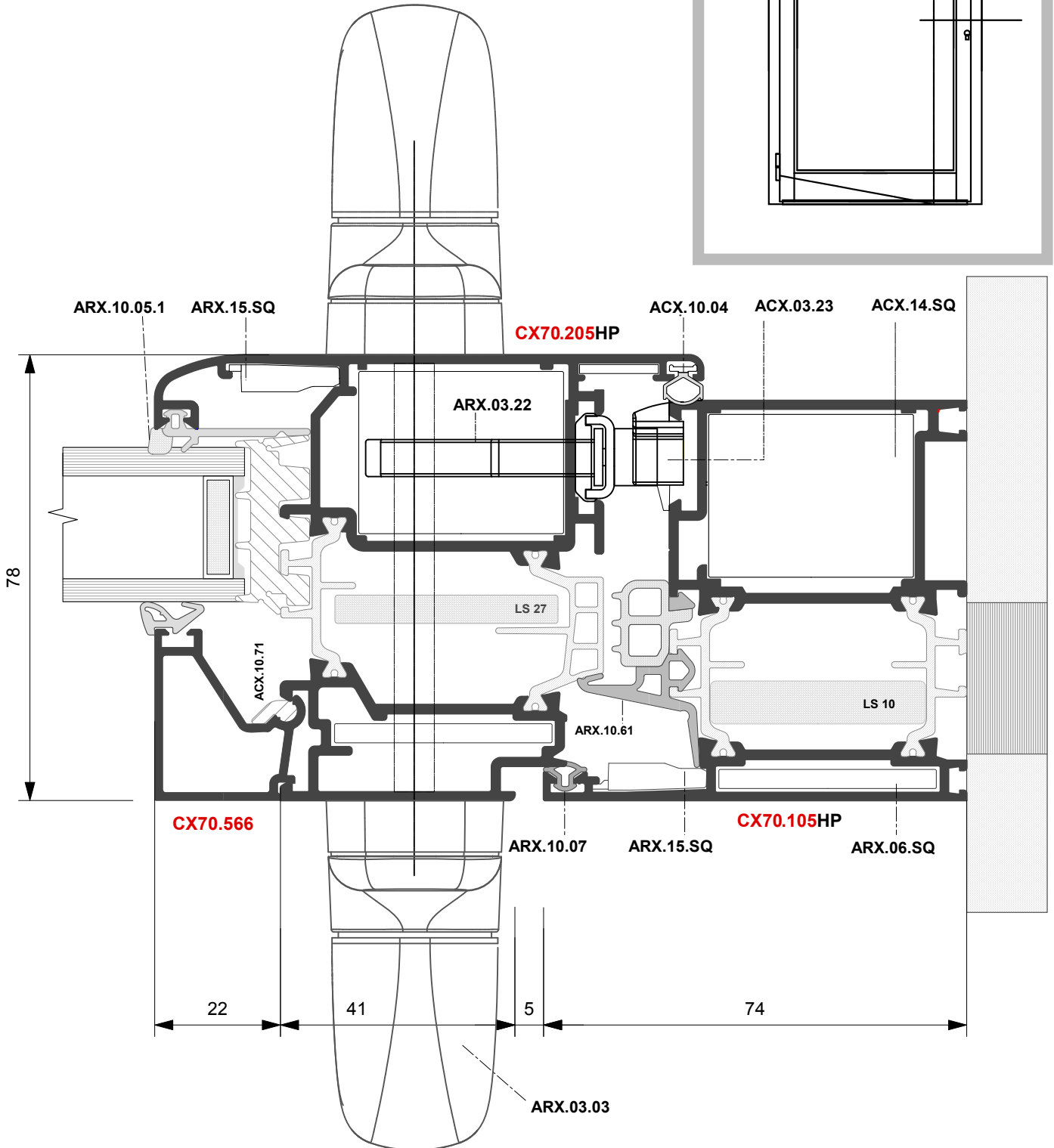
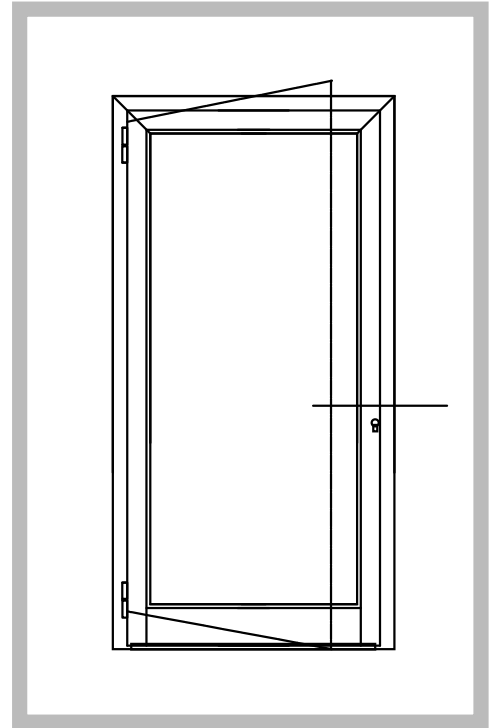

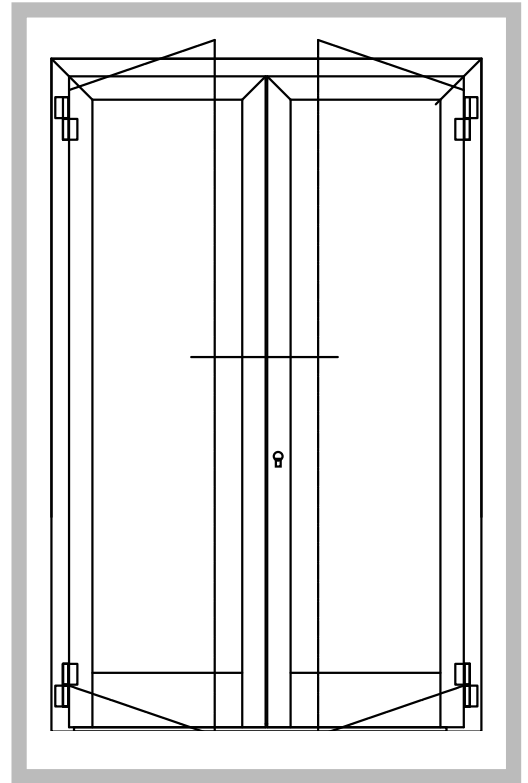
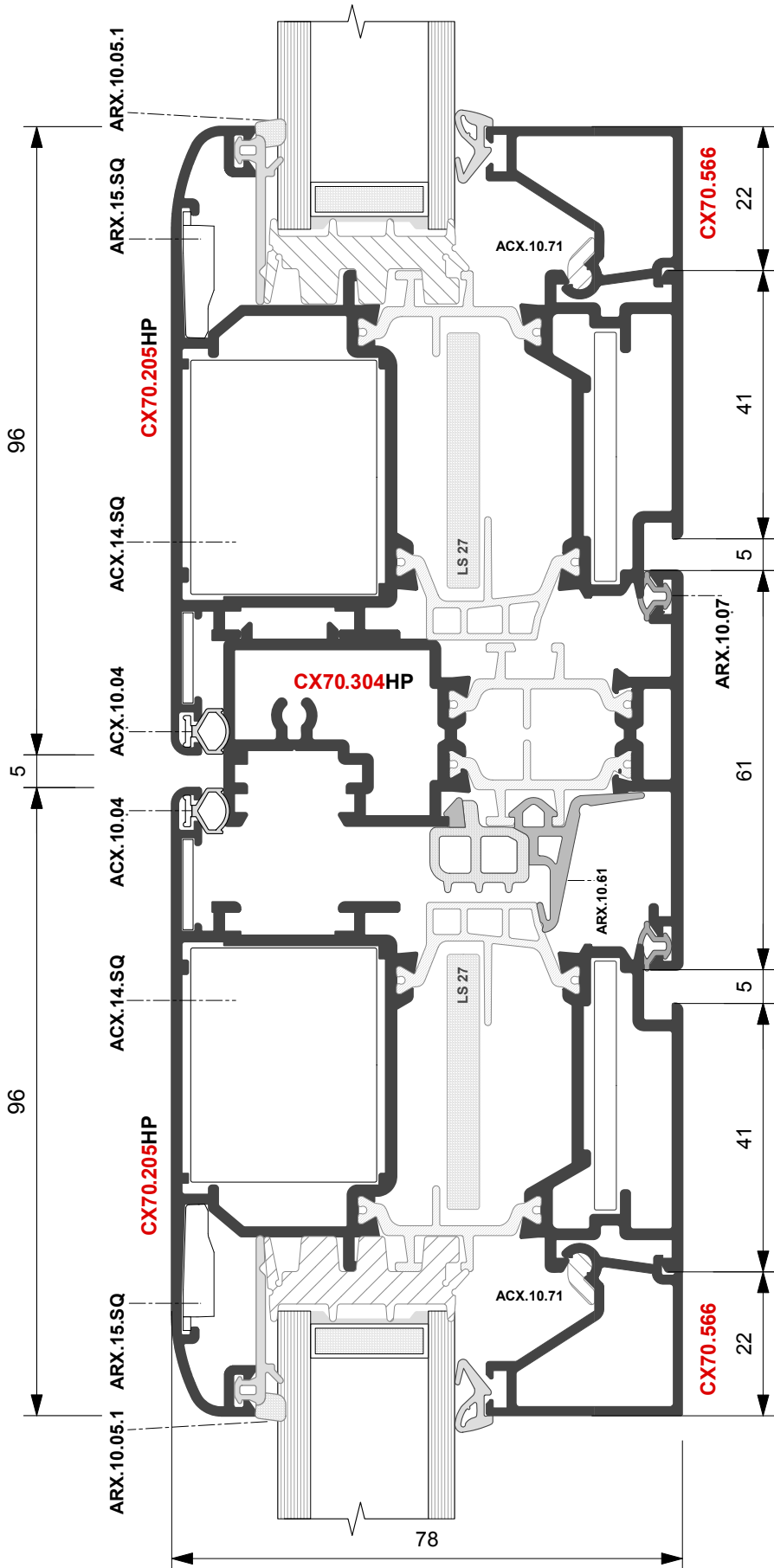

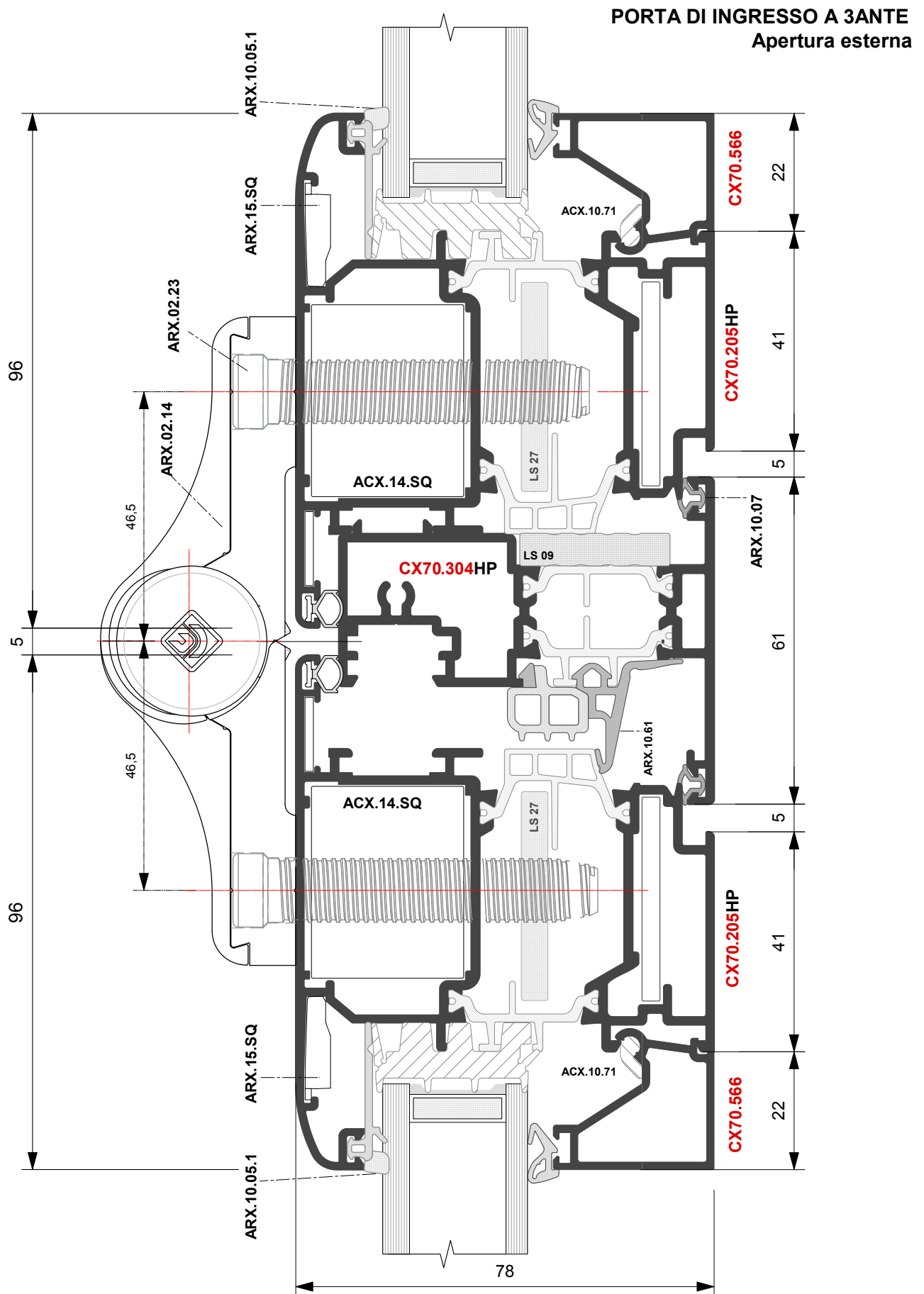



PORTA A DUE ANTE CON SOPRALUCE FISSO
Apertura esterna

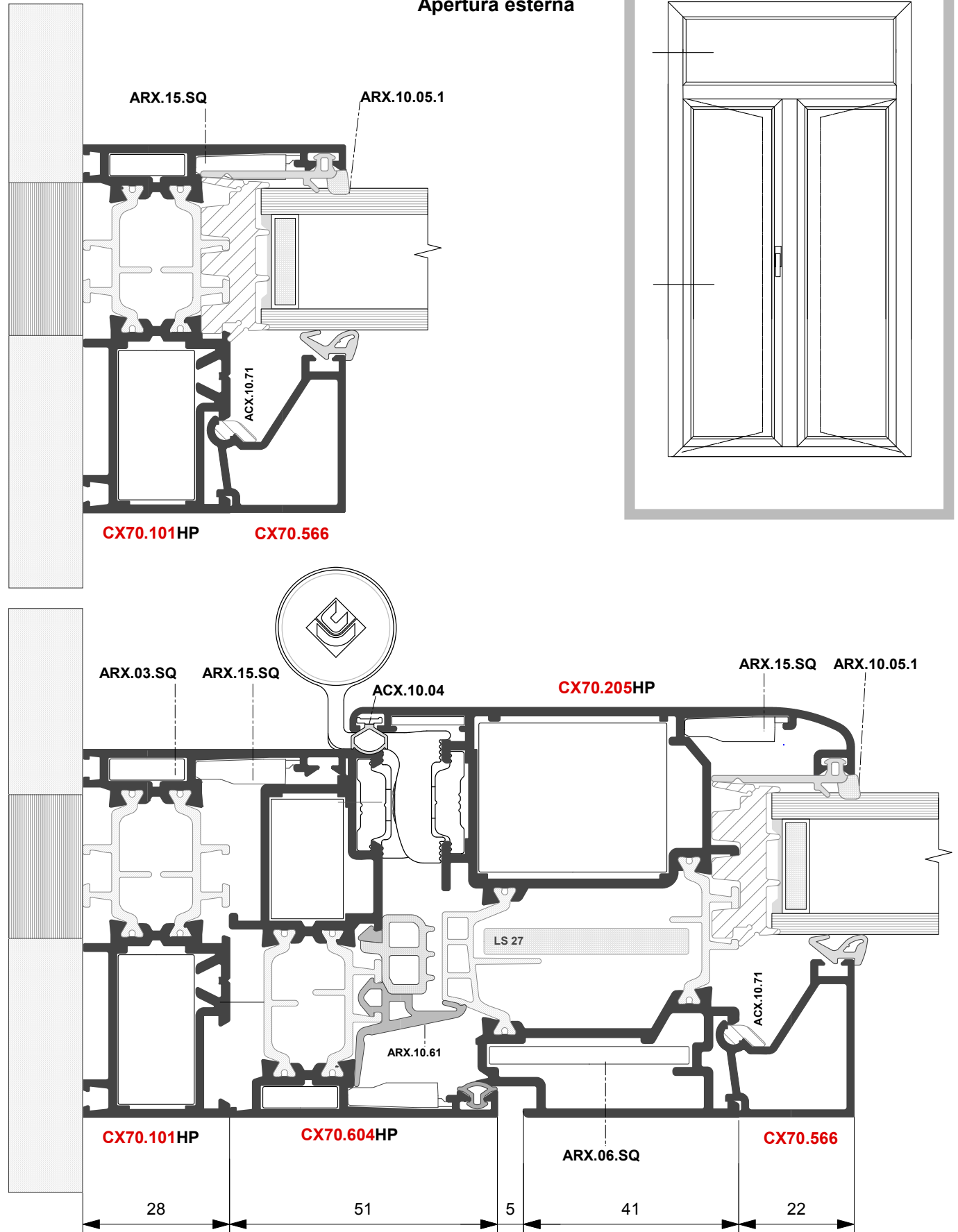



PORTA INGRESSO A DUE ANTE
Apertura interna

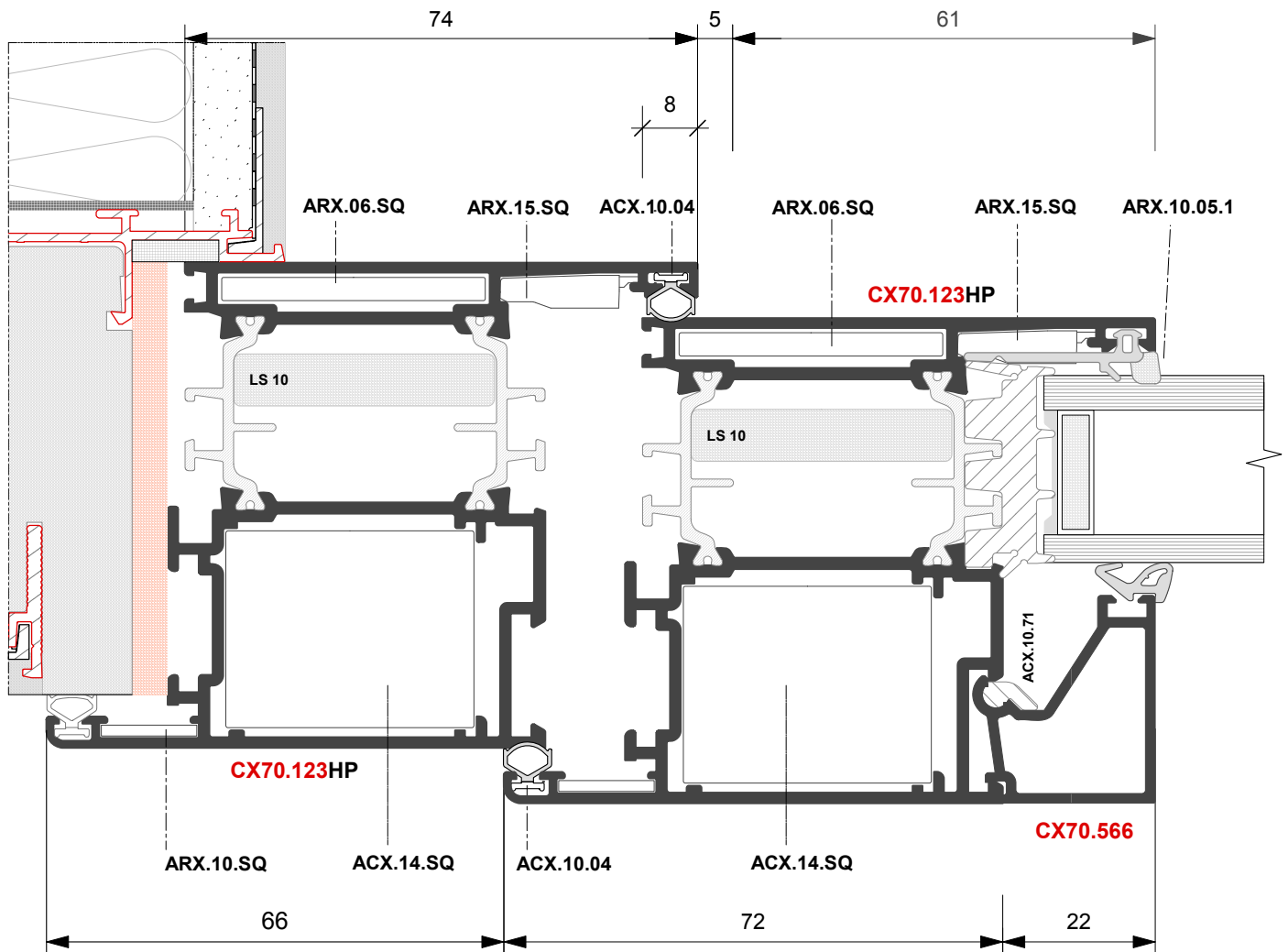
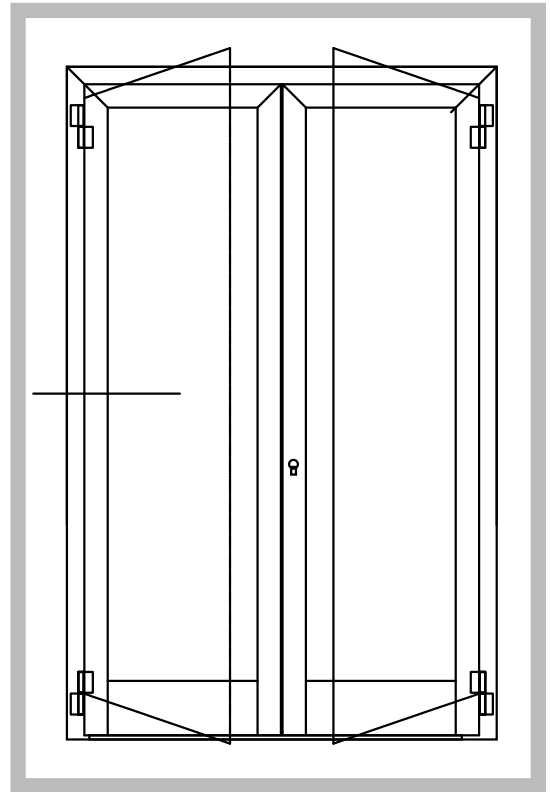



PORTA INGRESSO A DUE ANTE
Apertura interna

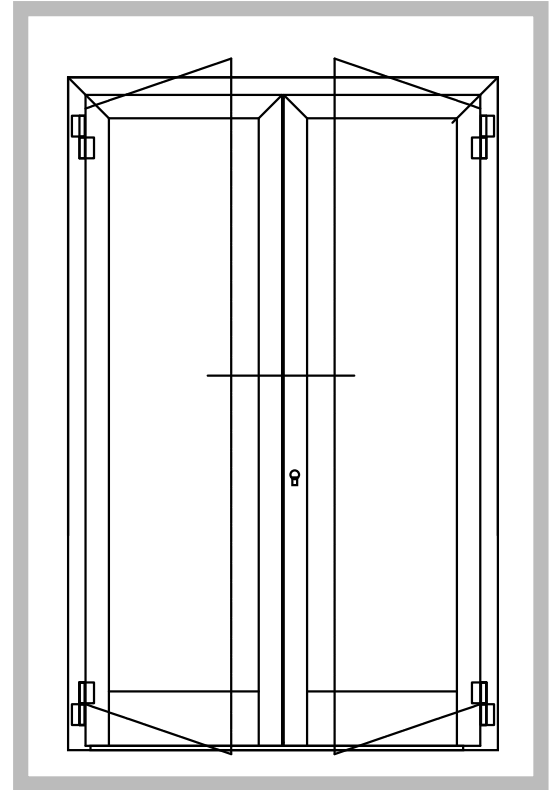
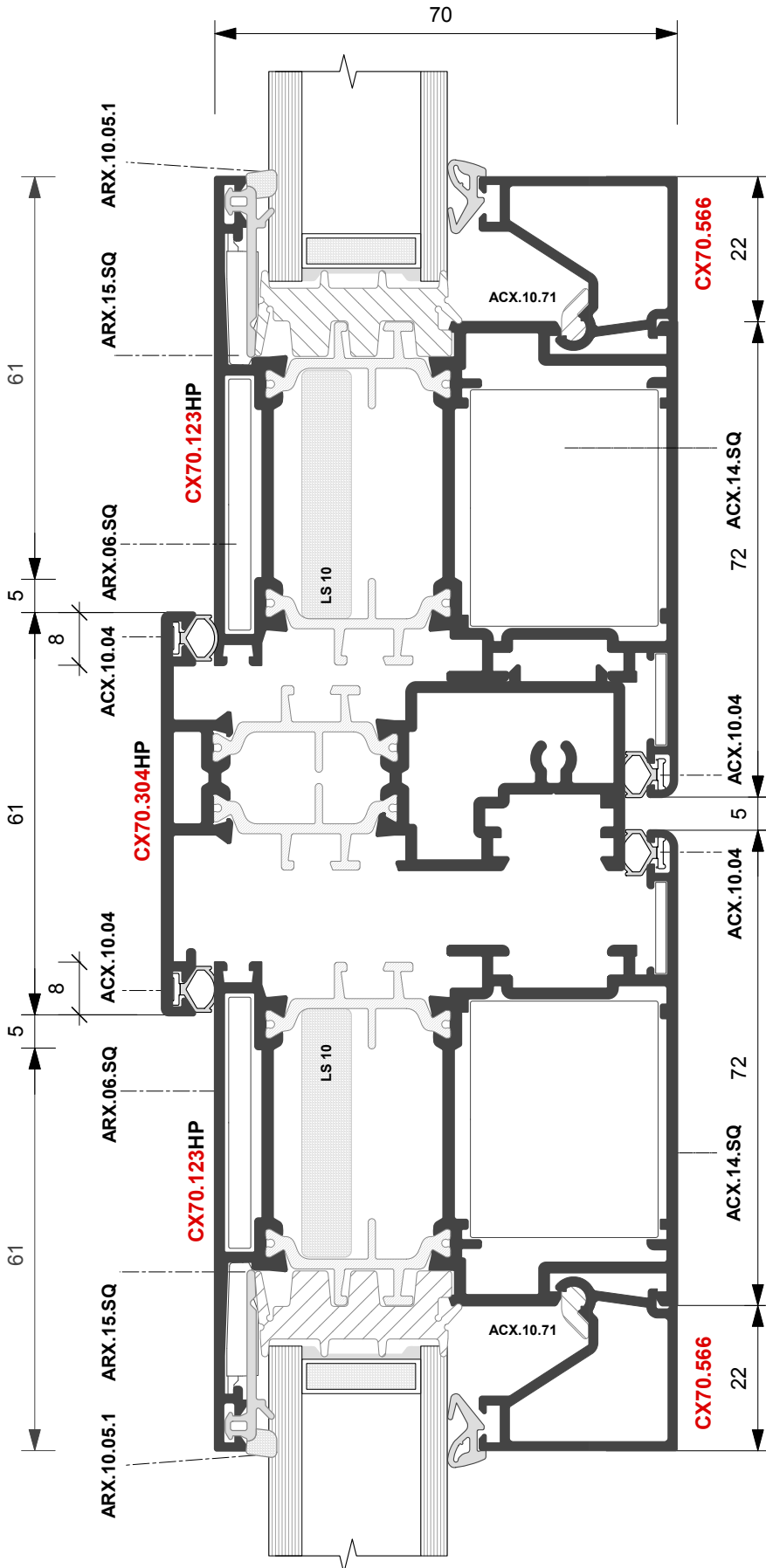



FINESTRA MONOBLOCCO

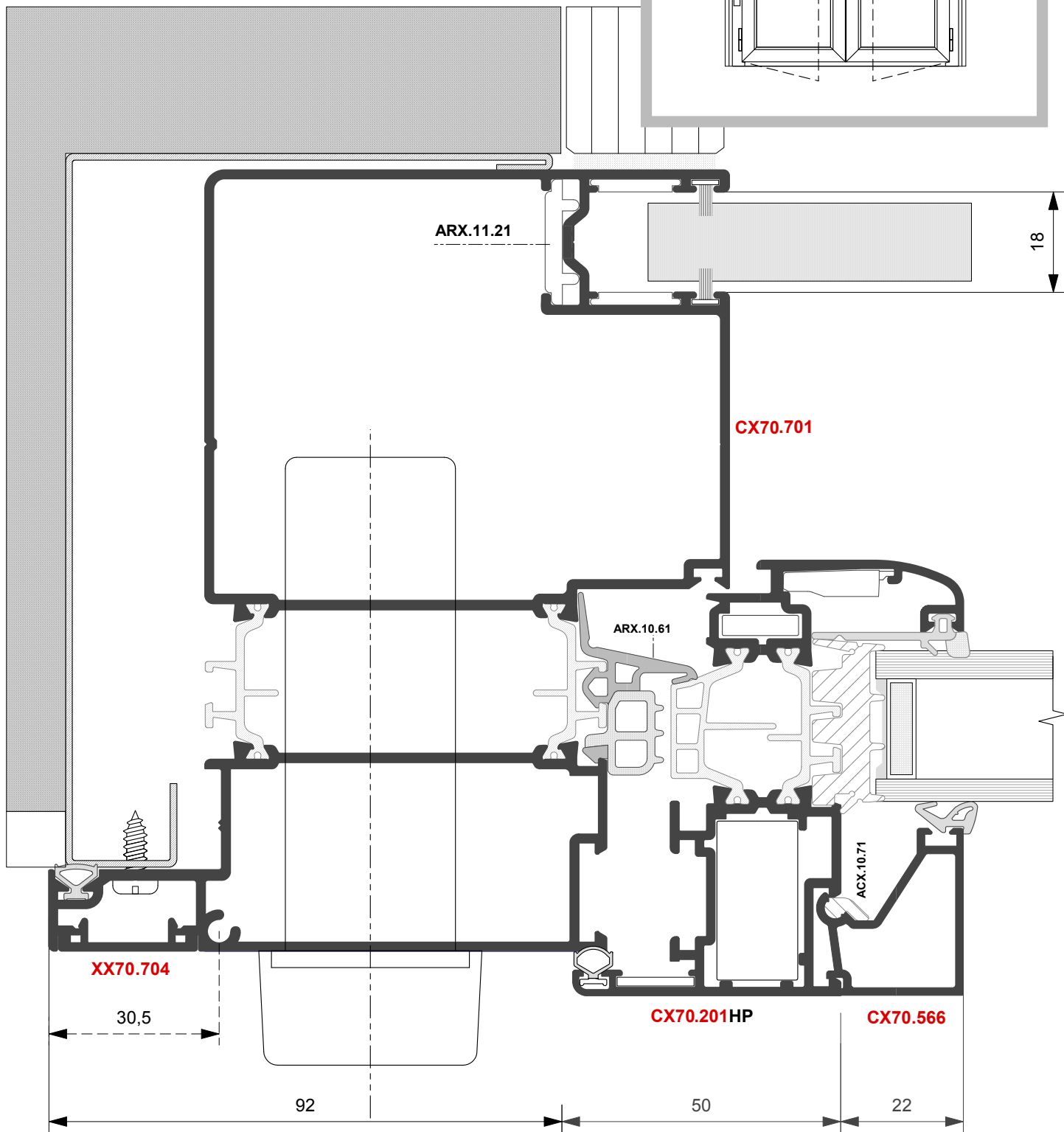
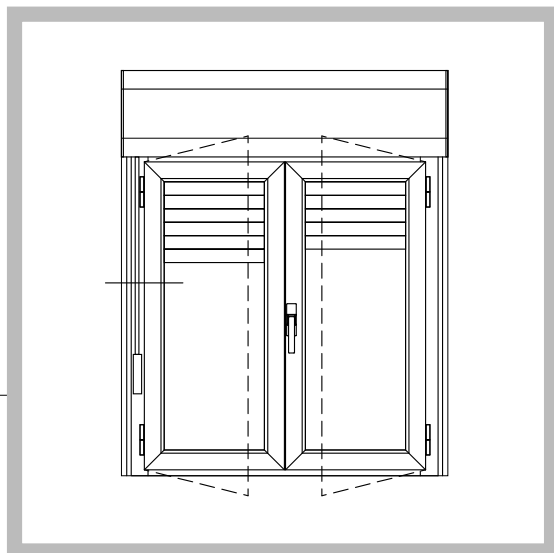



FINESTRA MONOBLOCCO

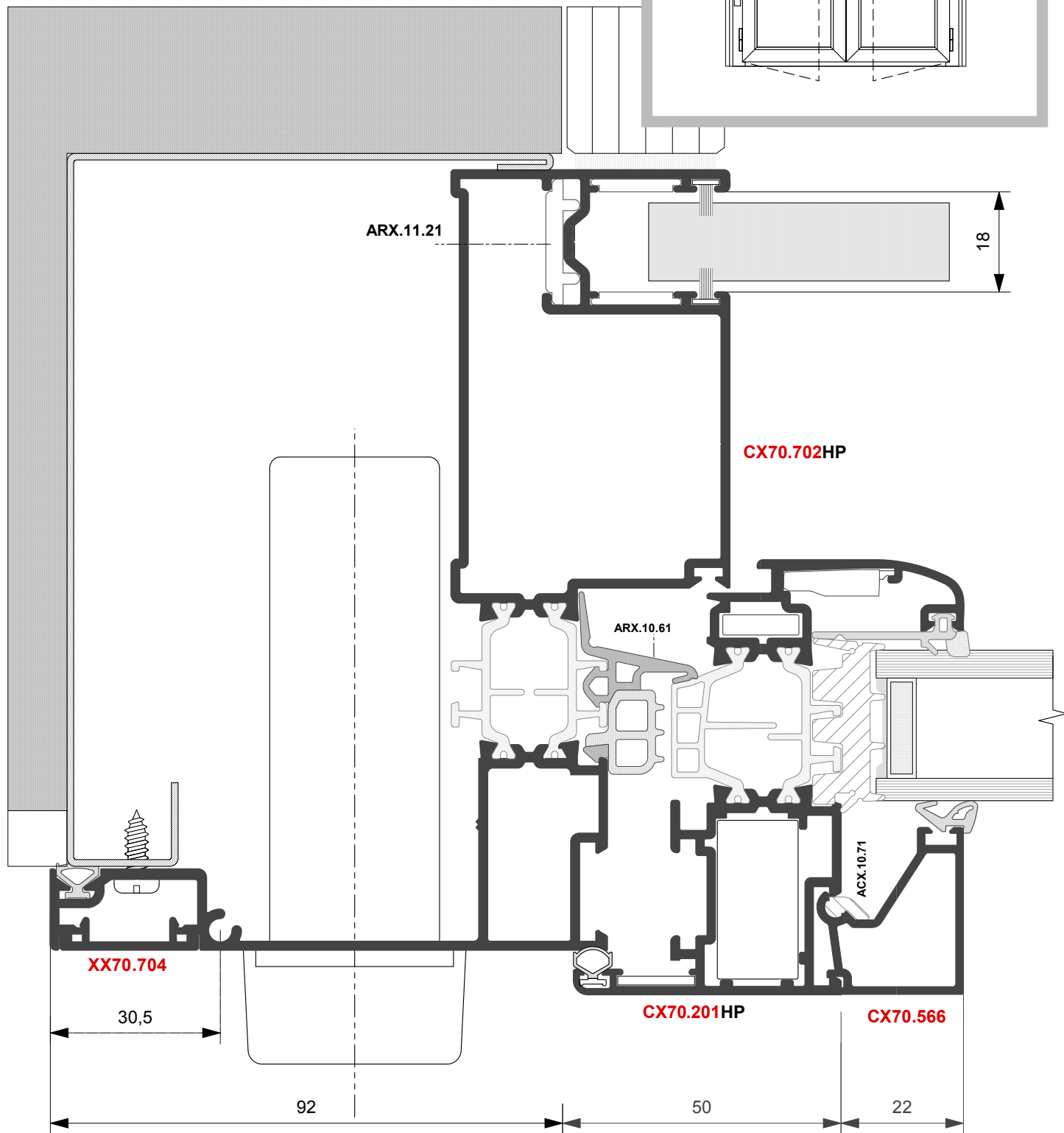
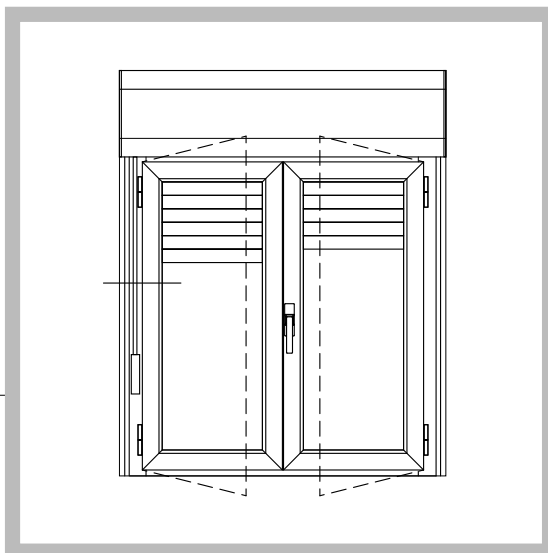



FINESTRA MONOBLOCCO

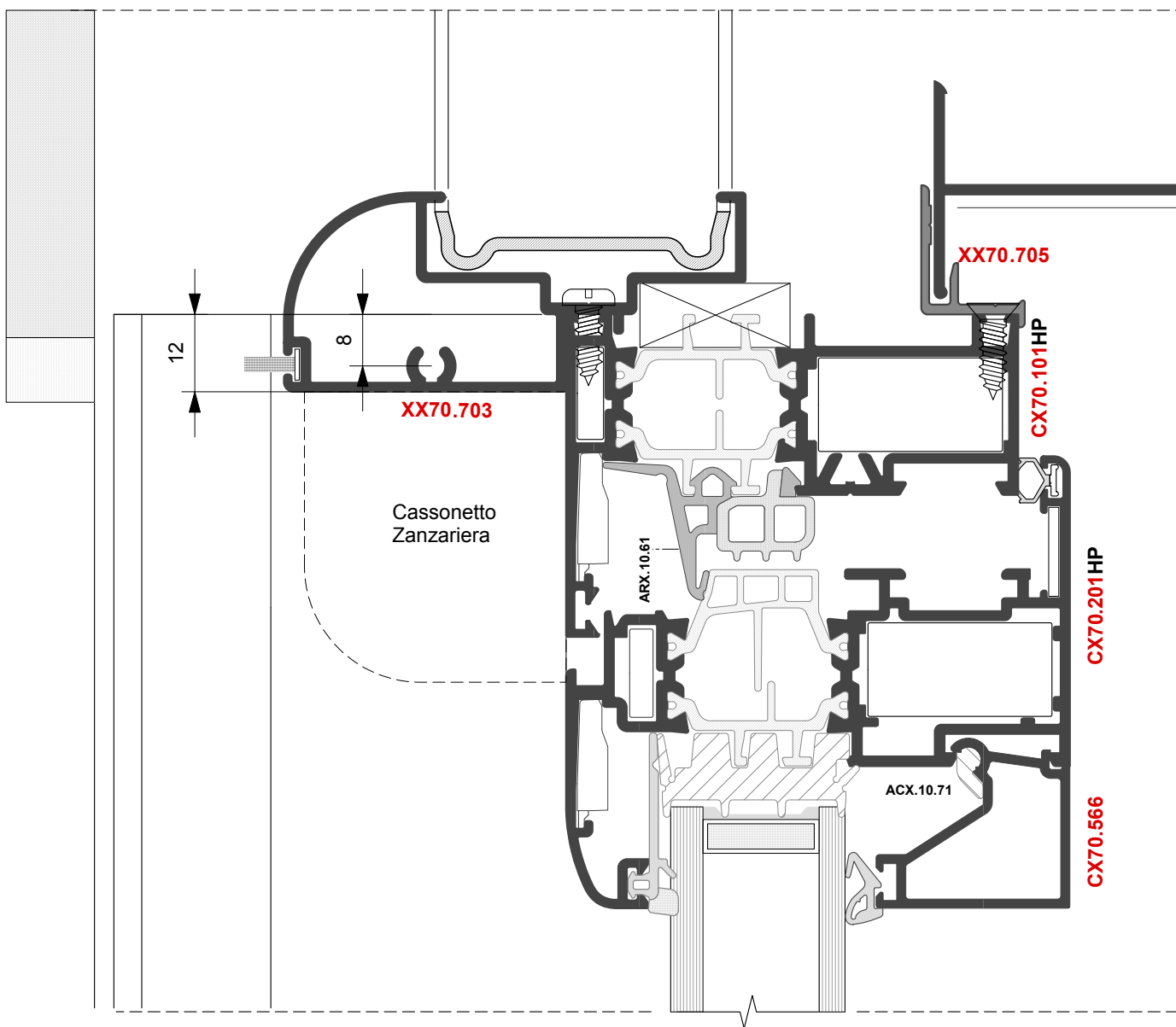
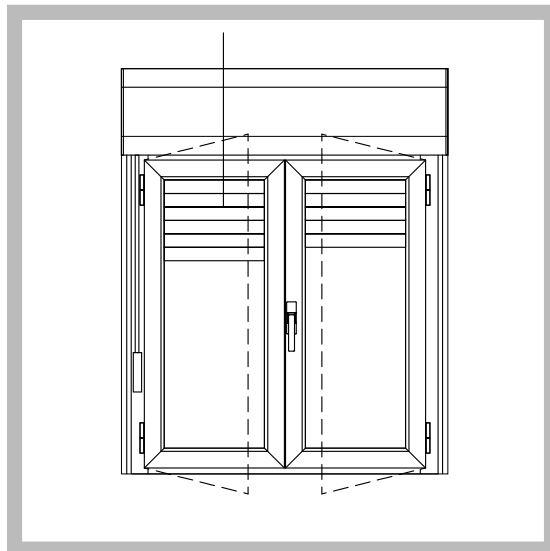



FINESTRA MONOBLOCCO

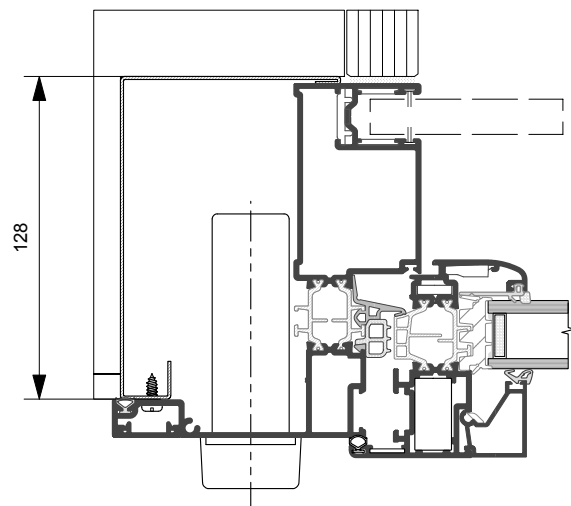
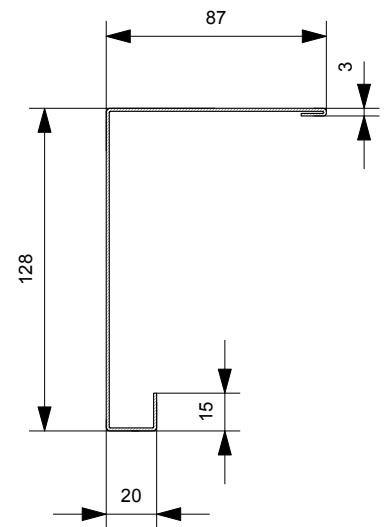
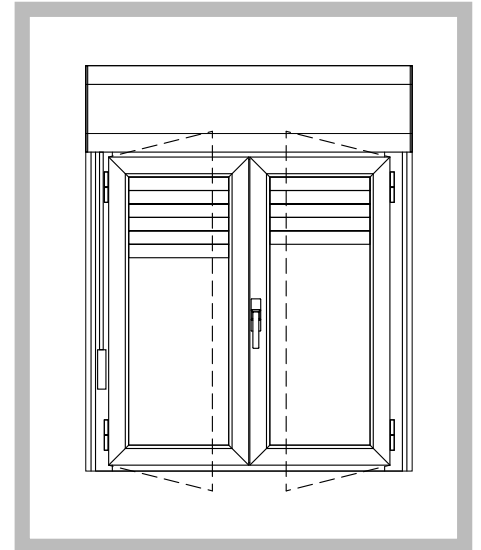
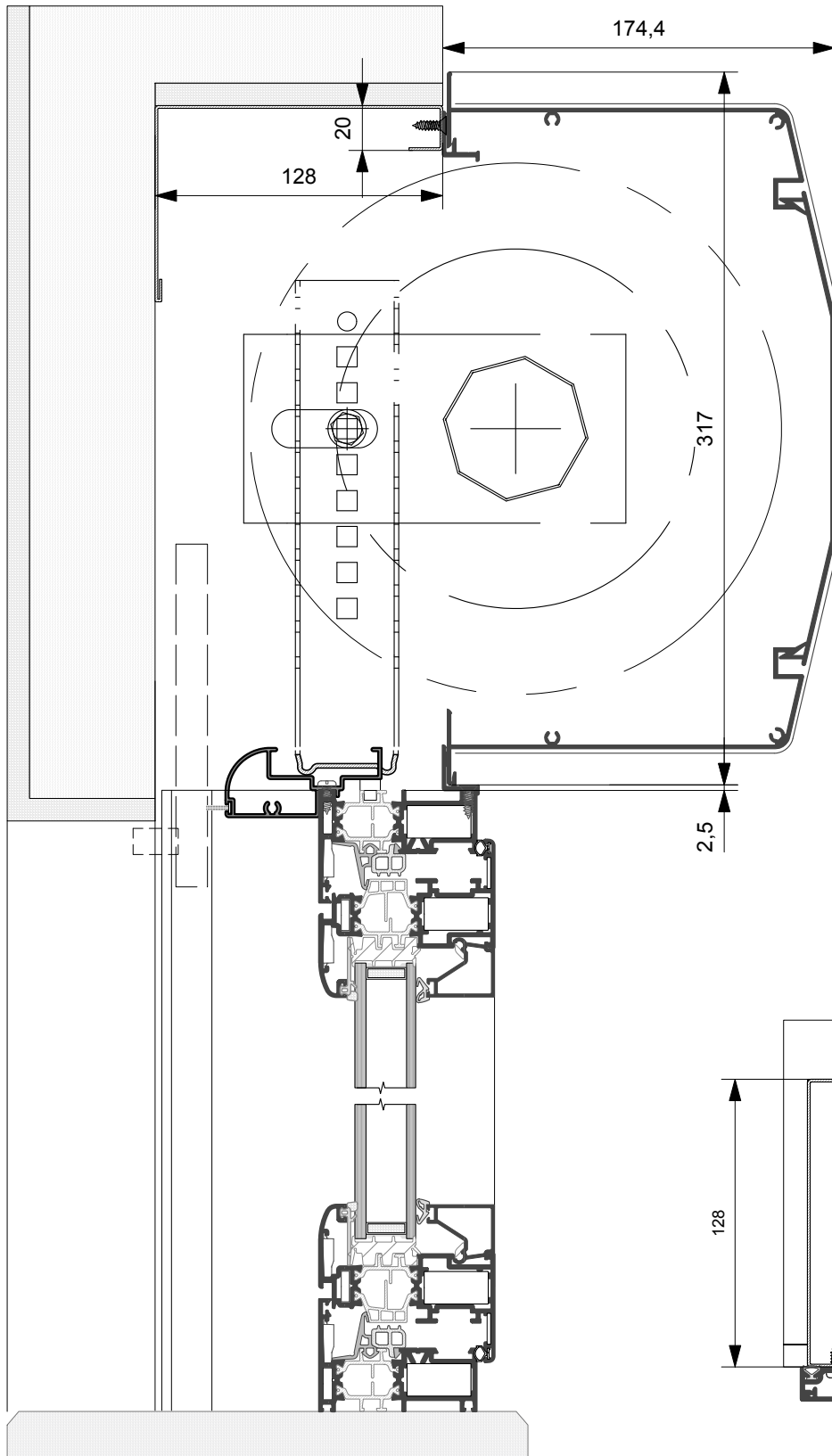



FINESTRA A DUE ANTE

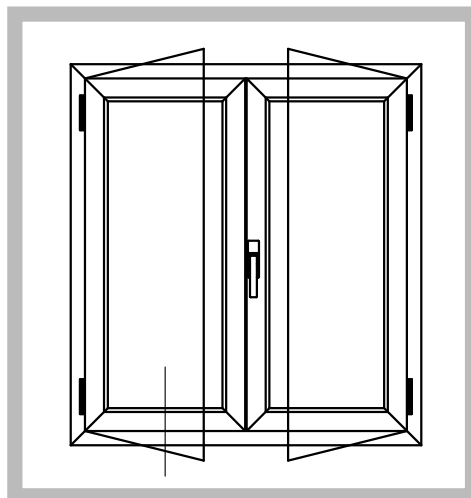
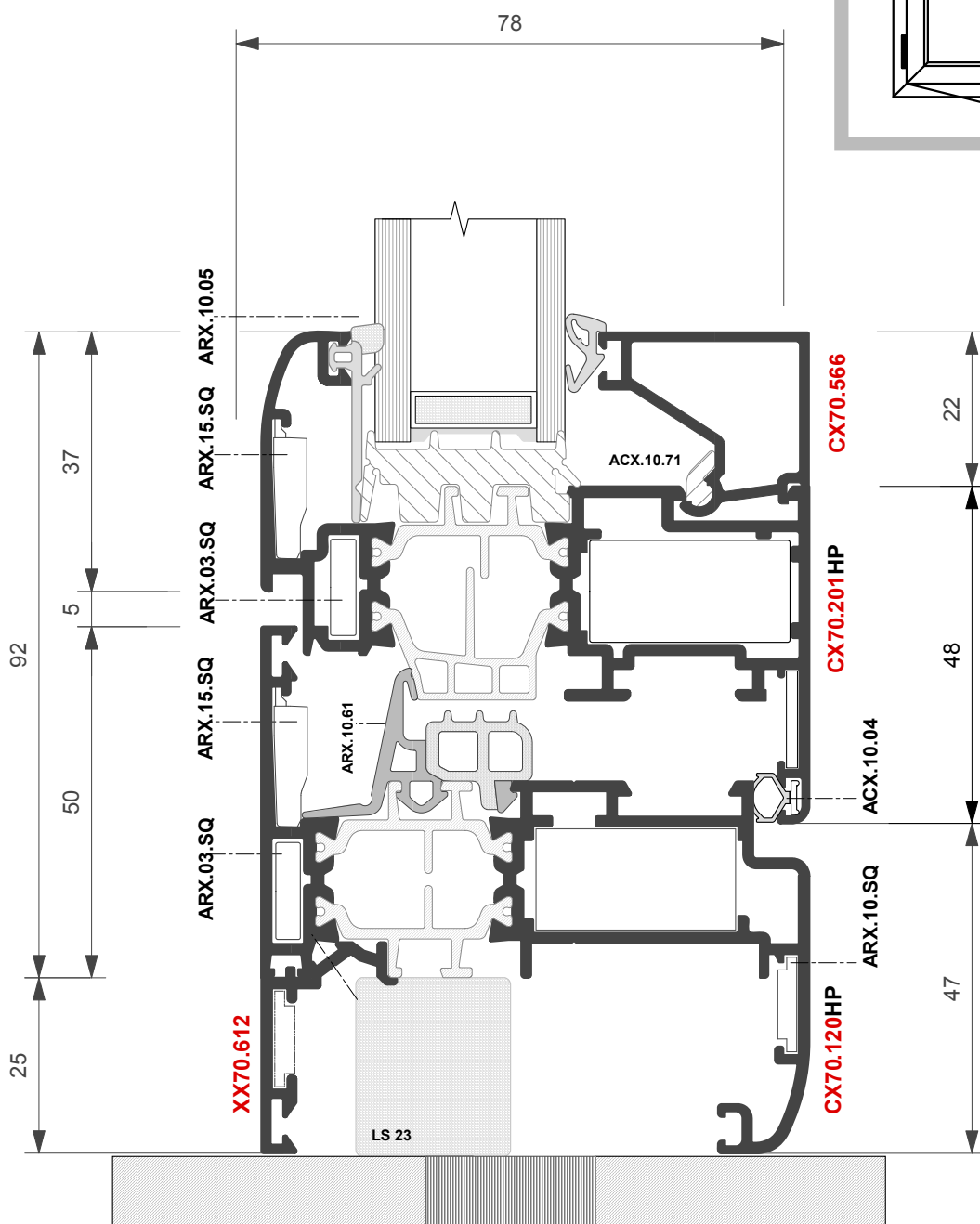



FINESTRA A DUE ANTE
con scuretto

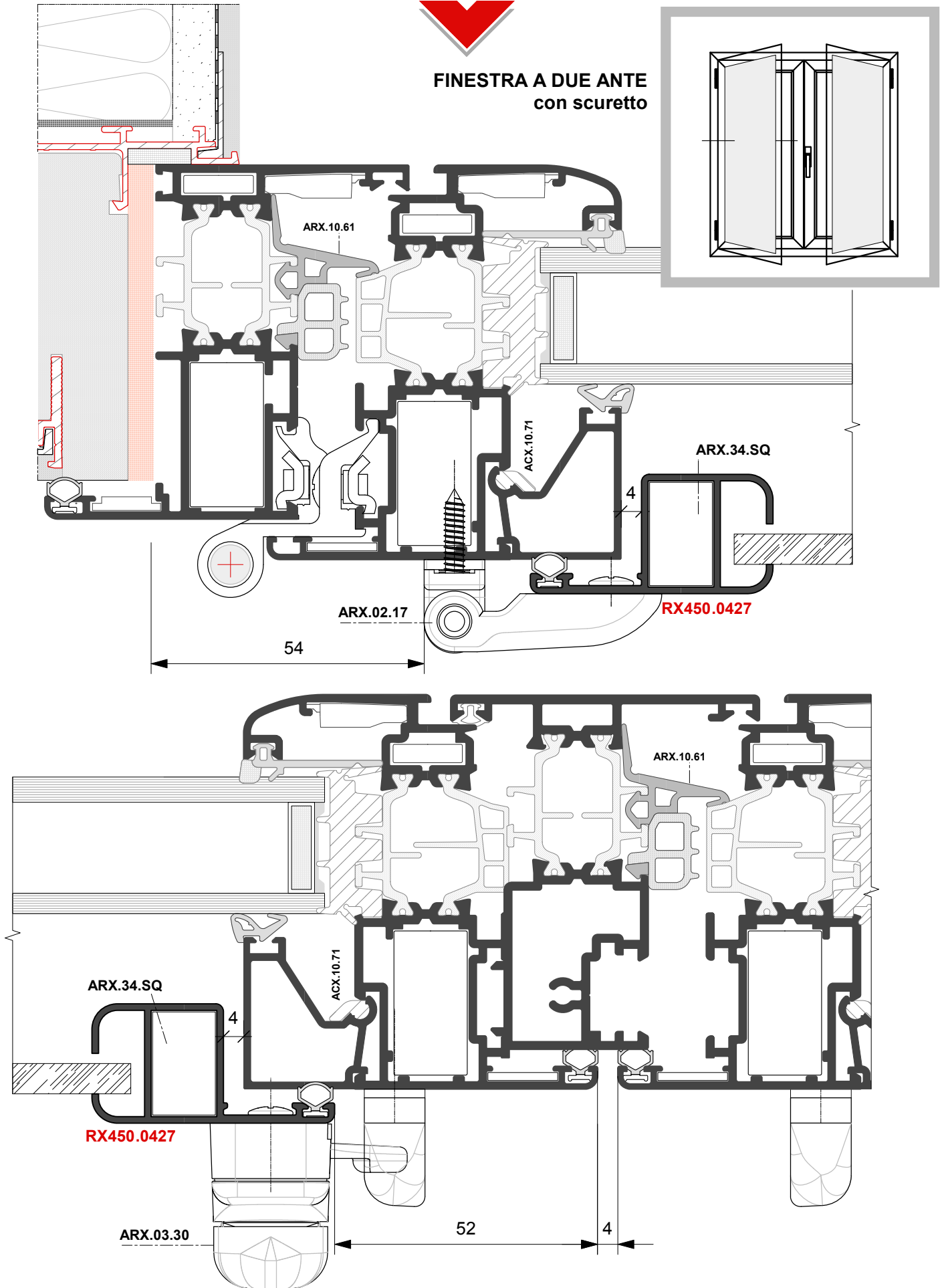



Serie **SLIM**
FINESTRA A DUE ANTE

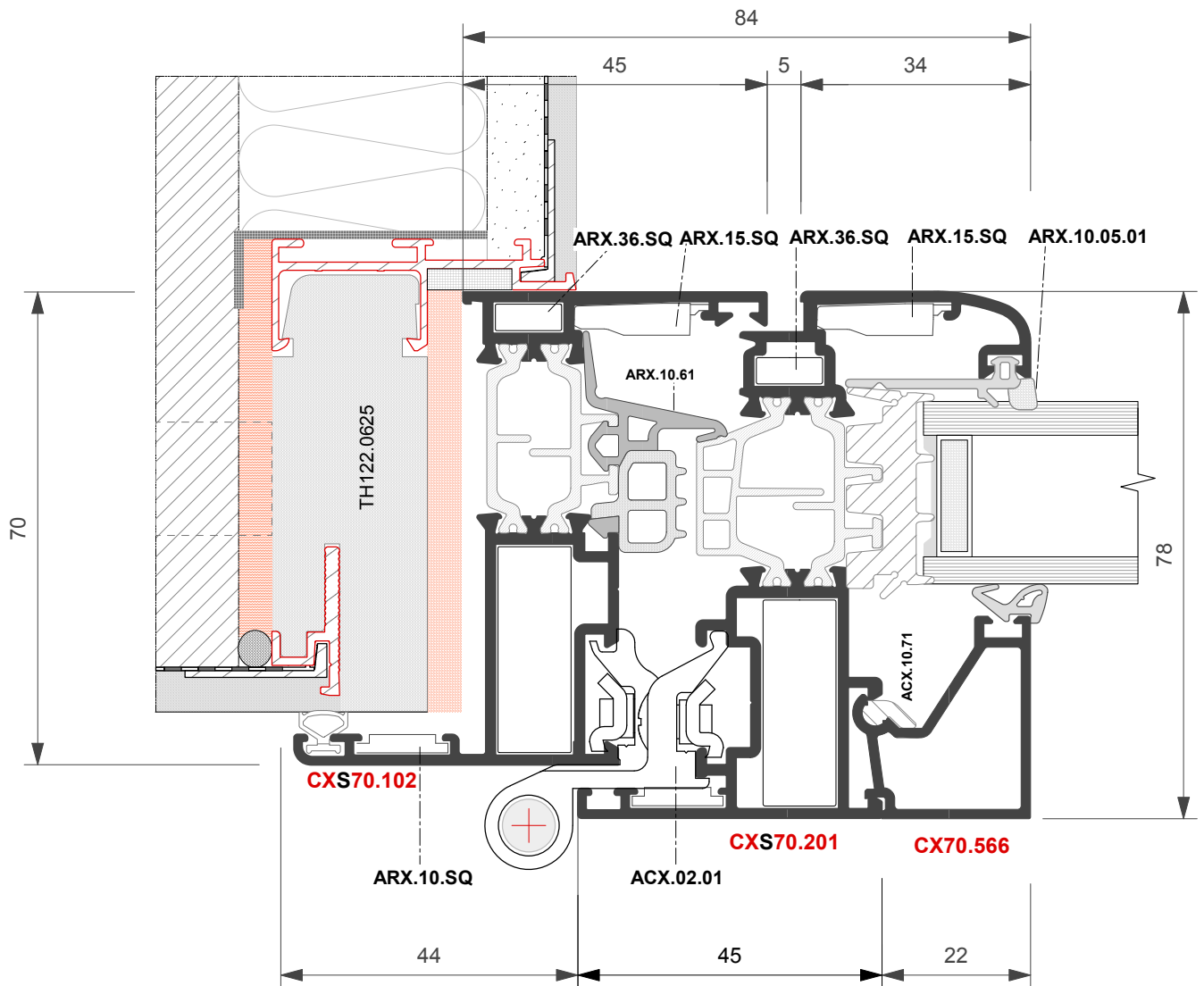
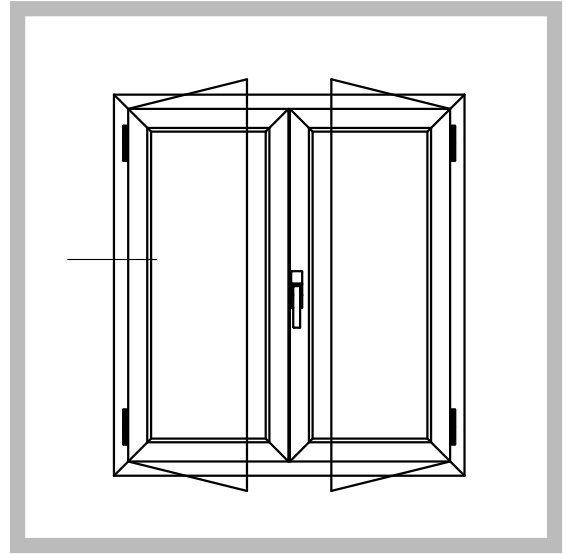



Serie **SLIM**
FINESTRA A DUE ANTE

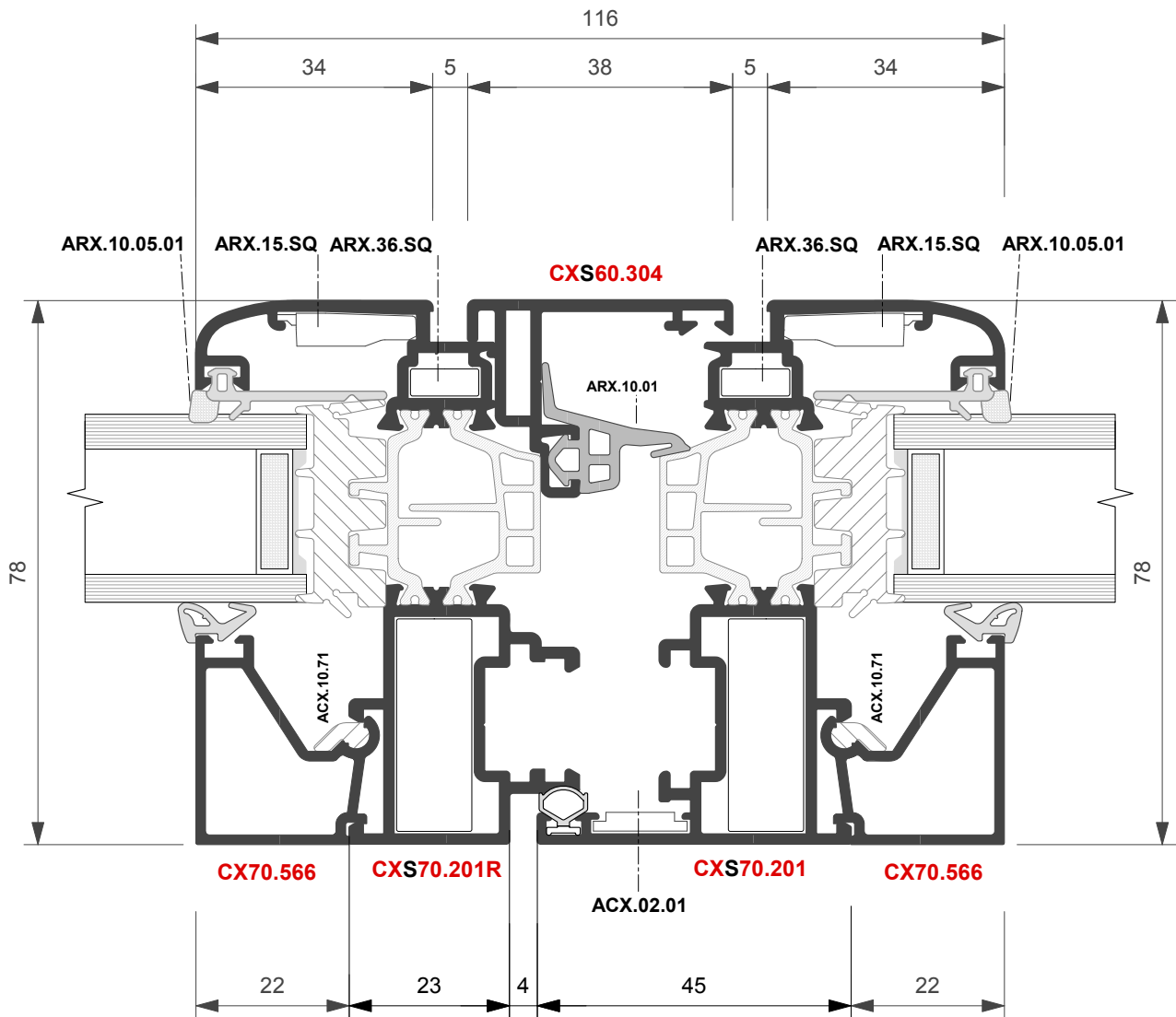
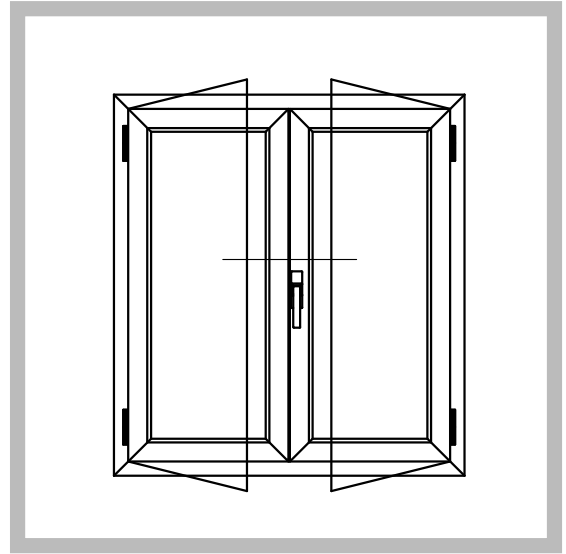



FINESTRA A DUE ANTE
Apertura esterna

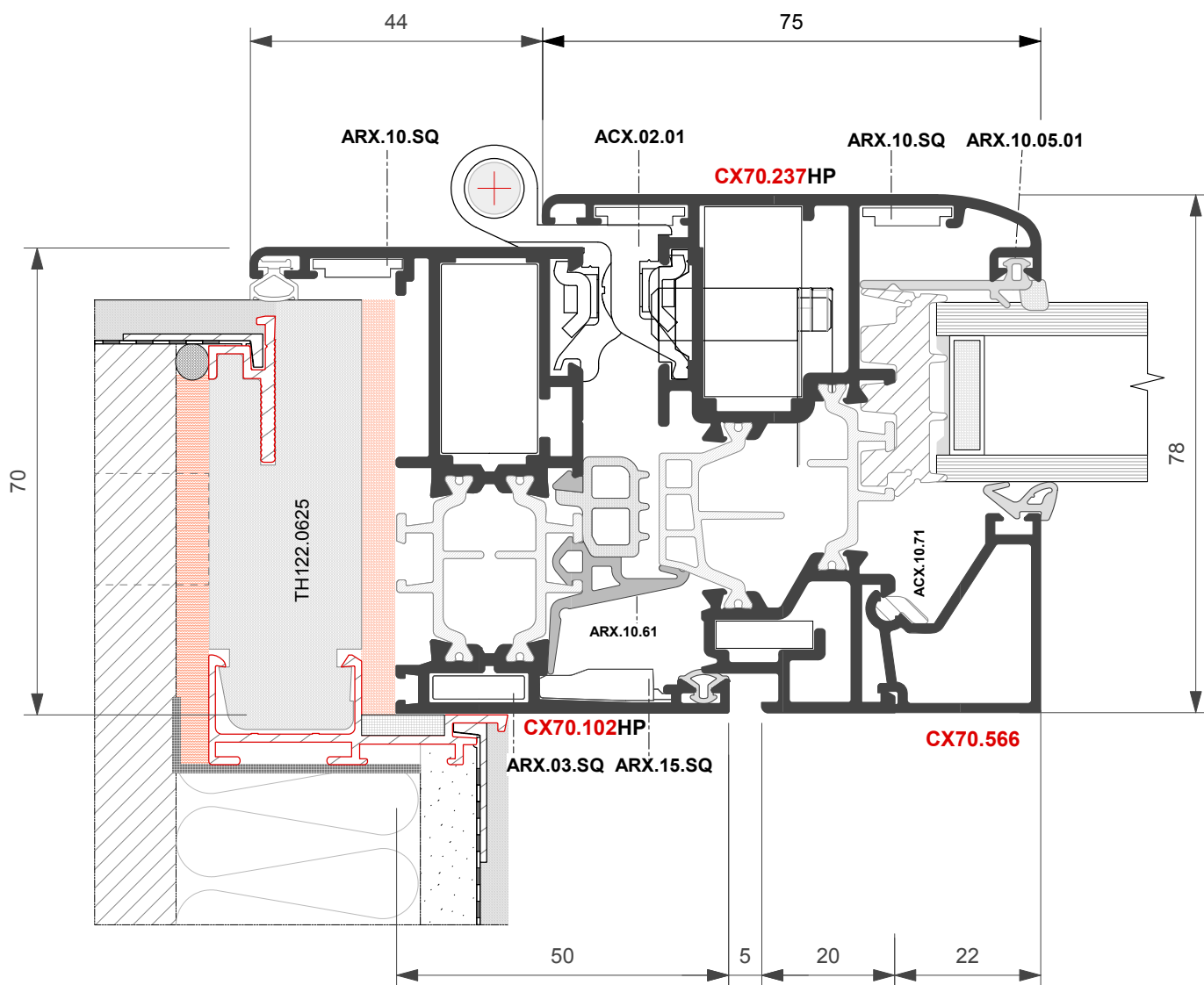
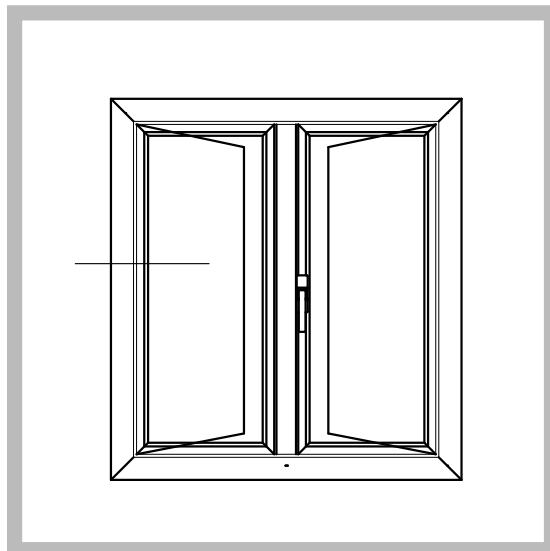



FINESTRA A DUE ANTE
Cerniera a scomparsa
Salto 10 mm.

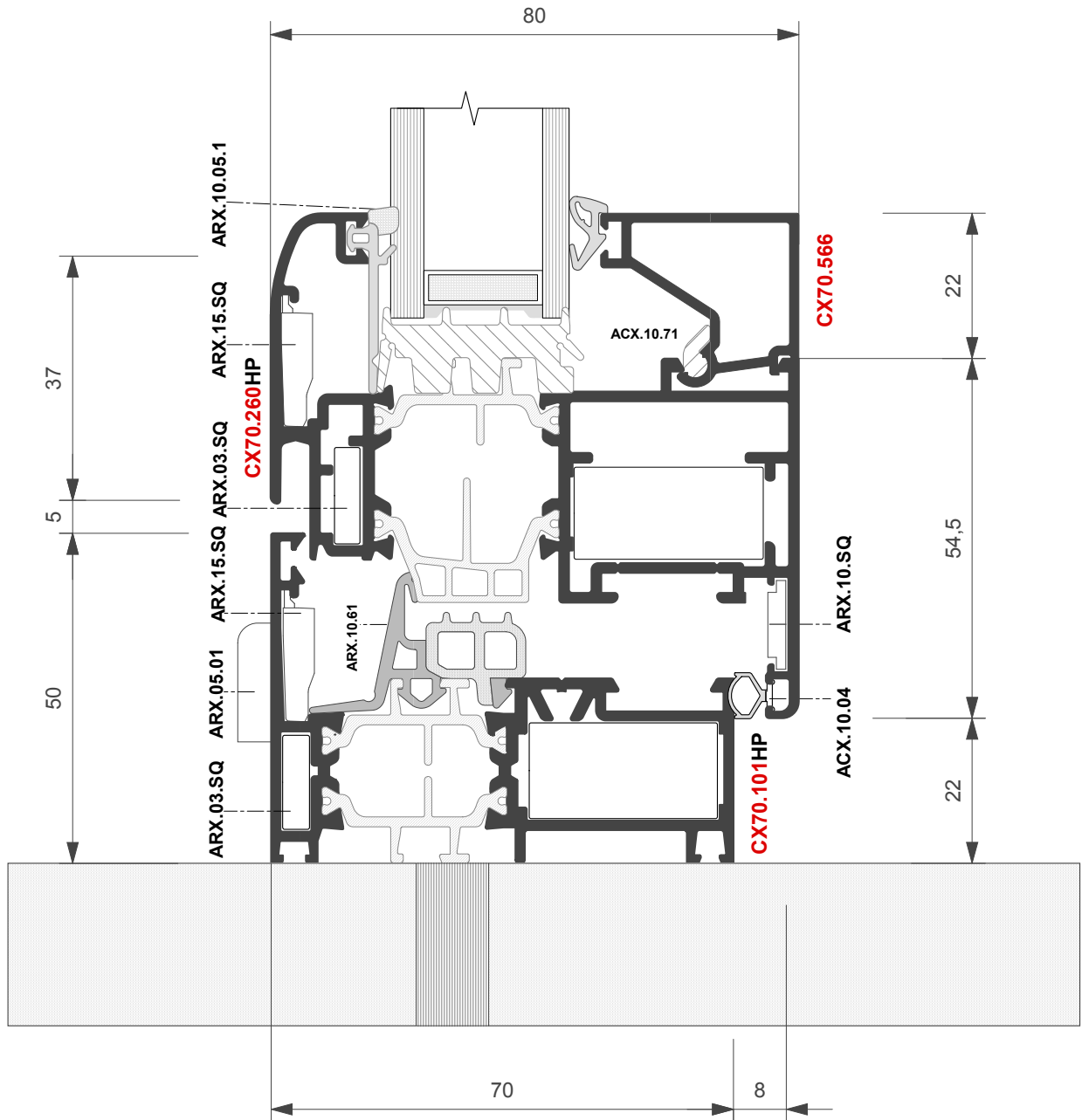
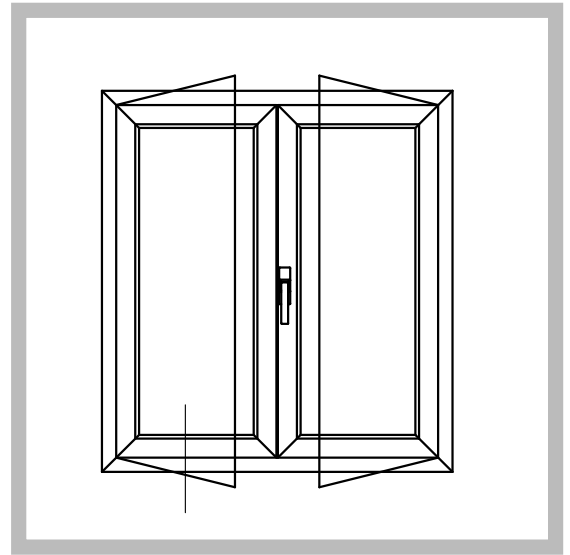

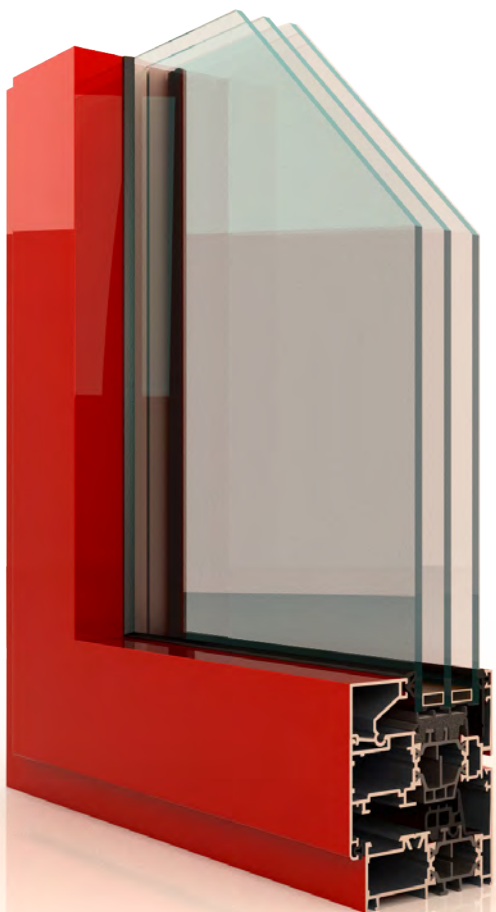

Tipologie

Gruppo E

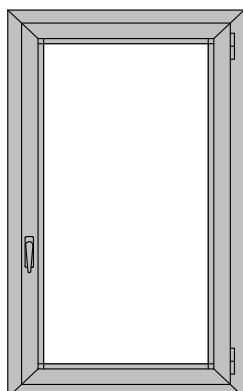

Finestra a 1 anta

Distinta di taglio vetri

Q.ta	H	L
1	H - 150	L - 150

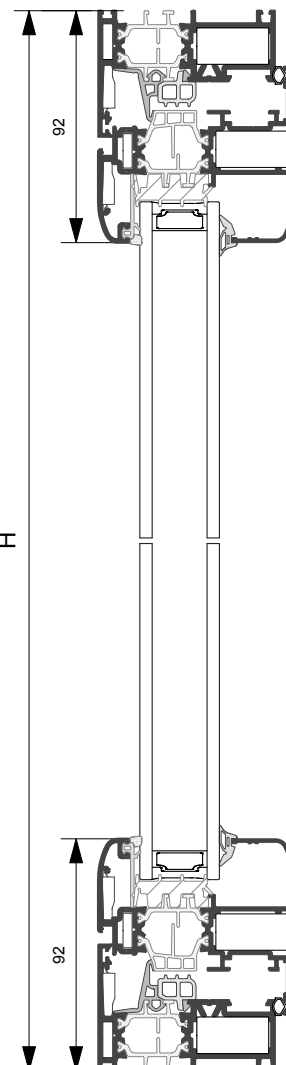
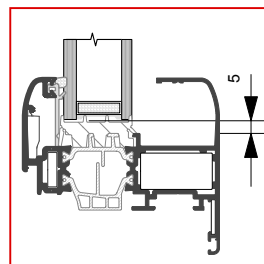

Accessori e guarnizioni

Codice	Descrizione	Q.ta	Codice	Descrizione	Q.ta
ACX.01.SQ	Squadretta a pulsante	8	ARX.05.01	Copriasola scarico acqua	2
ARX.03.SQ	Squadretta cianfrinare est.	8	ARX.06.01	Espansore	*
ARX.15.SQ	Squadretta allin. telaio/anta	8	ARX.10.61	Guarnizione precamera	2L,2H
ARX.10.SQ	Squadretta allin. anta int.	4	ACX.10.04	Guarnizione battuta	2L,2H
ACX.02.01	Cerniera a 2 ali	2	ARX.10.05.1	Guarnizione vetro esterna	2L,2H
ARX.03.06	Cremonese pressofusa	1	*	Guarnizione vetro interna	2L,2H
ACX.03.17	Innesti cremonese	2	ARX.10.62	Angolo guarn. precamera	4
ACX.03.18	Teminale astina	2	ARX.10.73	Guarnizione sottovetro	2L,2H
ACX.03.13	Ferrogliera	2	* secondo dimensioni		

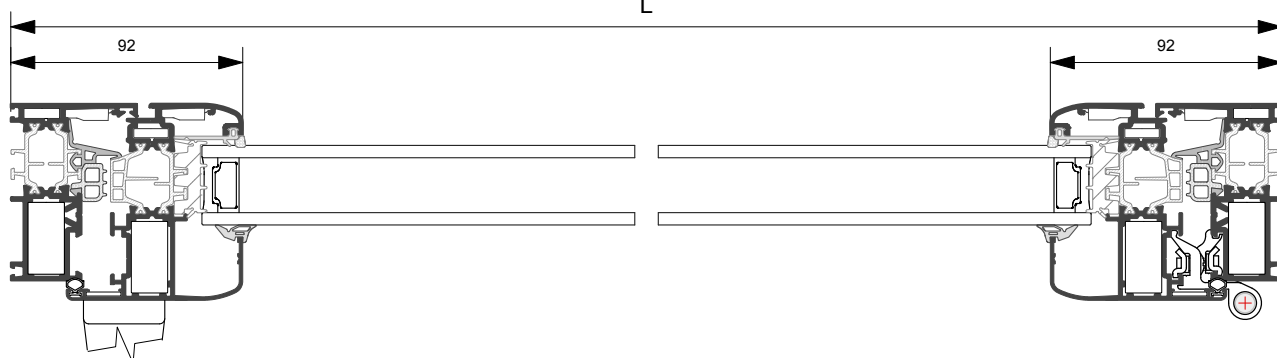

Profilo	Taglio	Q.ta	Profilo	Taglio	Q.ta	Profilo	Taglio	Q.ta
 CX70.101HP		2	 CX70.605					
		2						
 CX70.203HP		2						
		2						

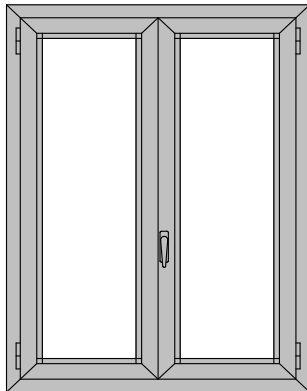

Finestra a 2 ante

Distinta di taglio vetri

Q.tà	H	L
2	H -150	L/2 -132

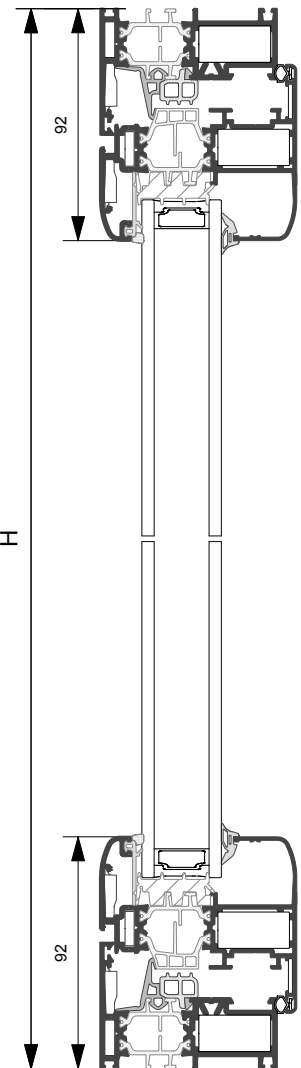
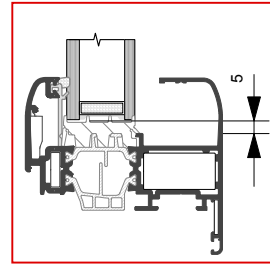

Accessori e guarnizioni

Codice	Descrizione	Q.ta	Codice	Descrizione	Q.ta
ACX.01.SQ	Squadretta a pulsante	12	ACX.04.01	Tappo riporto centrale	1
ARX.03.SQ	Squadretta cianfrinare est.	12	ARX.05.01	Copriasola scarico acqua	2
ARX.15.SQ	Squadretta allin. telaio/anta	12	ARX.06.01	Espansore	*
ARX.10.SQ	Squadretta allin. anta int.	8	ARX.10.61	Guarnizione precamera	2L,3H
ACX.02.01	Cerniera a 2 ali	4	ACX.10.04	Guarnizione battuta	2L,4H
ARX.03.06	Cremonese pressofusa	1	ARX.10.05.1	Guarnizione vetro esterna	2L,4H
ACX.03.17	Innesti cremonese	2	*	Guarnizione vetro interna	2L,4H
ACX.03.18	Teminale astina	2	ARX.10.62	Angolo guarn. precamera	4
ACX.03.11	Paletto a spinta	2	ARX.10.73	Guarnizione sottovetro	2L,4H
ACX.03.14	Ferrogliera	2	* secondo dimensioni		

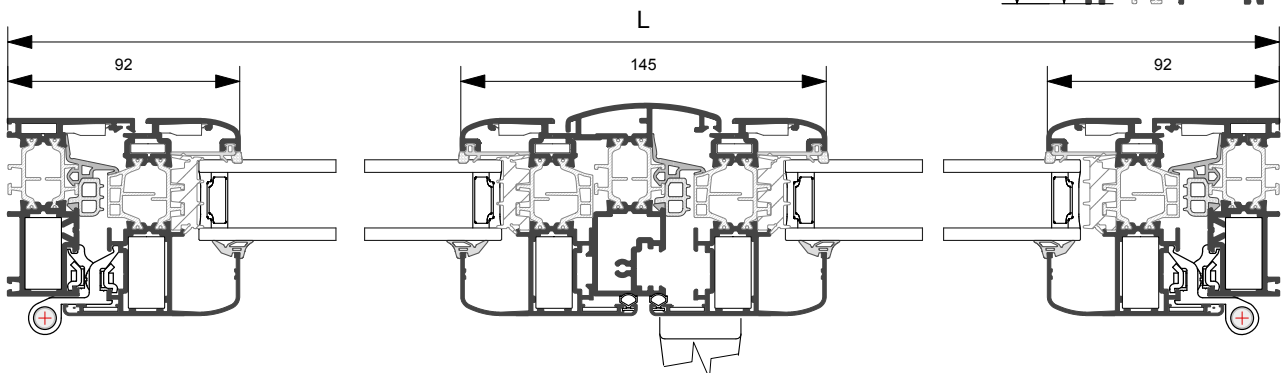

Profilo	Taglio	Q.ta	Profilo	Taglio	Q.ta	Profilo	Taglio	Q.ta
CX70.101HP	L	2	CX70.301HP	H - 110	1			
	H	2						
CX70.203HP	L/2 - 24.5	4	CX70.605					
	H - 44	4						

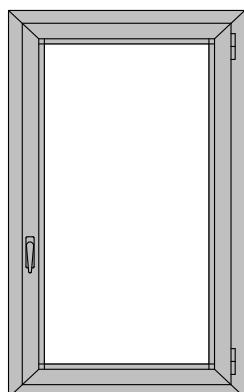

Finestra a 1 anta

Distinta di taglio vetri		
Q.ta	H	L
1	H -150	L -150

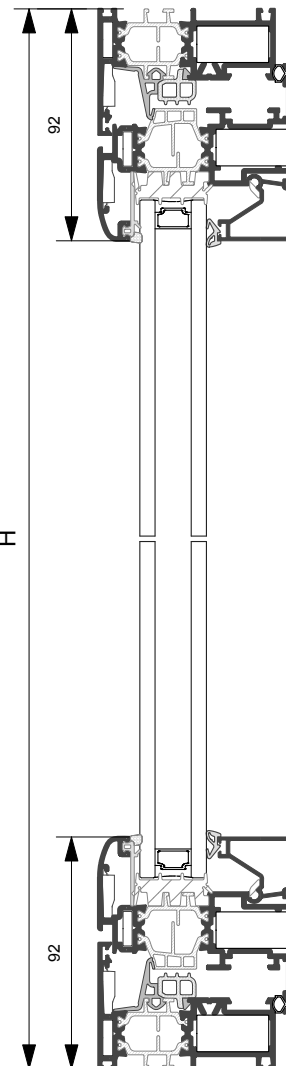
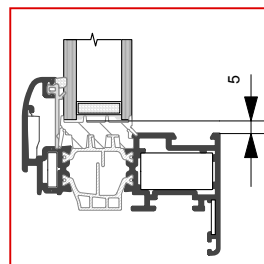

Accessori e guarnizioni

Codice	Descrizione	Q.ta	Codice	Descrizione	Q.ta
ACX.01.SQ	Squadretta a pulsante	8	ARX.05.01	Copriasola scarico acqua	2
ARX.03.SQ	Squadretta cianfrinare est.	8	ARX.06.01	Espansore	*
ARX.15.SQ	Squadretta allin. telaio/anta	8	ARX.10.61	Guarnizione precamera	2L,2H
ARX.10.SQ	Squadretta allin. anta int.	4	ACX.10.04	Guarnizione battuta	2L,2H
ACX.02.01	Cerniera a 2 ali	2	ARX.10.05.1	Guarnizione vetro esterna	2L,2H
ARX.03.06	Cremonese pressofusa	1	*	Guarnizione vetro interna	2L,2H
ACX.03.17	Innesti cremonese	2	ARX.10.62	Angolo guarn. precamera	4
ACX.03.18	Teminale astina	2	ACX.10.71	Guarn. sostegno fermavetro	
ACX.03.13	Ferrogliera	2	ARX.10.73	Guarnizione sottovetro	2L,2H

* secondo dimensioni

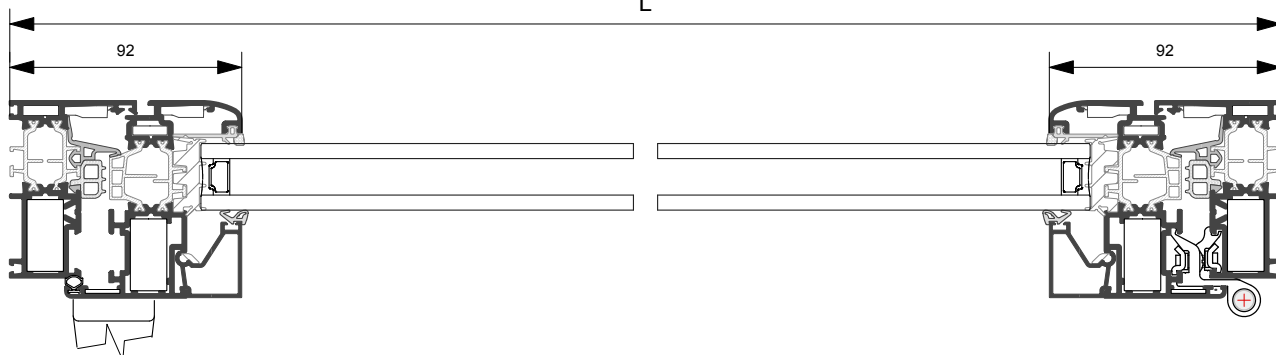

Profilo	Taglio	Q.ta	Profilo	Taglio	Q.ta	Profilo	Taglio	Q.ta
 CX70.101HP	L	2	 CX70.566	L - 184	2			
	H	2		H - 184	2			
 CX70.201HP	L - 44	2	 CX70.605					
	H - 44	2						

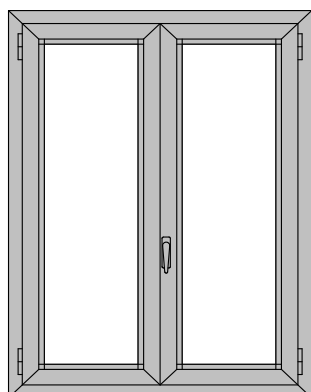

Finestra a 2 ante

Distinta di taglio vetri		
Q.tà	H	L
2	H - 150	L/2 - 132

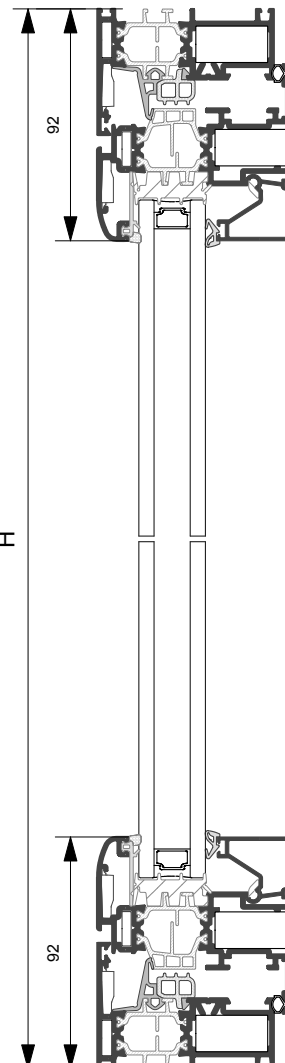
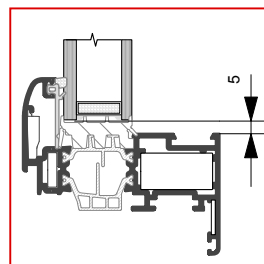

Accessori e guarnizioni

Codice	Descrizione	Q.ta	Codice	Descrizione	Q.ta
ACX.01.SQ	Squadretta a pulsante	12	ACX.04.01	Tappo riporto centrale	1
ARX.03.SQ	Squadretta cianfrinare est.	12	ARX.05.01	Copriasola scarico acqua	2
ARX.15.SQ	Squadretta allin. telaio/anta	12	ARX.06.01	Espansore	*
ARX.10.SQ	Squadretta allin. anta int.	8	ARX.10.61	Guarnizione precamera	2L,3H
ACX.02.01	Cerniera a 2 ali	4	ACX.10.04	Guarnizione battuta	2L,4H
ARX.03.06	Cremonese pressofusa	1	ARX.10.05.1	Guarnizione vetro esterna	2L,4H
ACX.03.17	Innesti cremonese	2	*	Guarnizione vetro interna	2L,4H
ACX.03.18	Teminale astina	2	ARX.10.62	Angolo guarn. precamera	4
ACX.03.11	Paletto a spinta	2	ACX.10.71	Guarn. sostegno fermavetro	
ACX.03.14	Ferrogliera	2	ARX.10.73	Guarnizione sottovetro	2L,4H

* secondo dimensioni

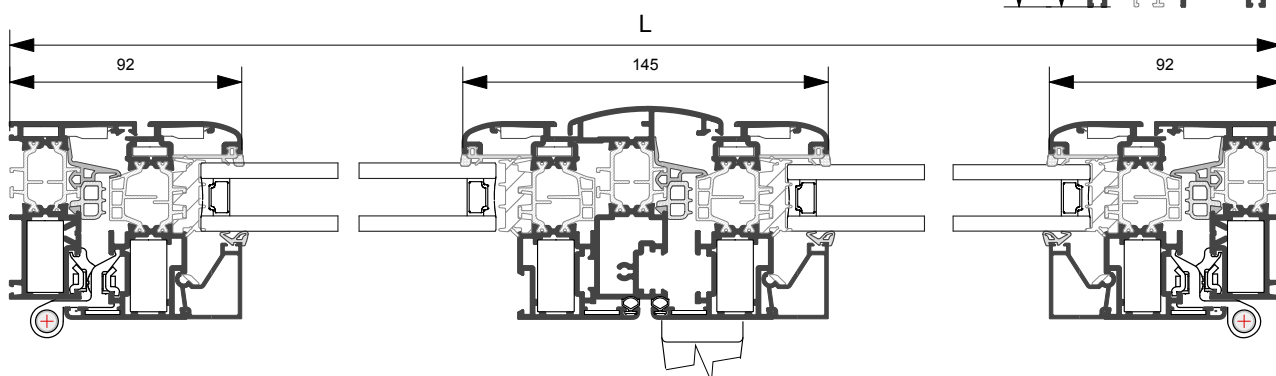

Profilo	Taglio	Q.ta	Profilo	Taglio	Q.ta	Profilo	Taglio	Q.ta
CX70.101HP	L	2	CX70.566	L/2 - 164.5	4	CX70.605		
	H	2		H - 184	4			
CX70.201HP	L/2 - 24.5	4	CX70.301HP					
	H - 44	4		H - 110	1			

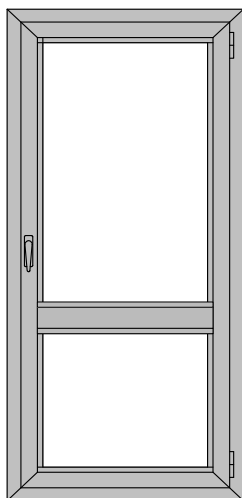

Porta a 1 anta

Distinta di taglio vetri		
Q.tà	H	L
1	H-HF-58	L -150
1	HF -154	L -150

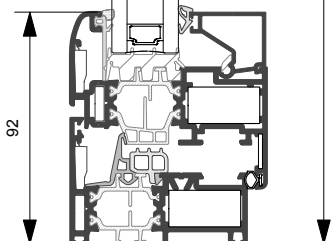
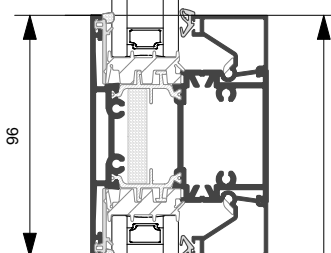
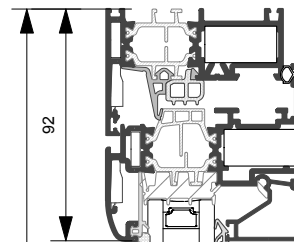
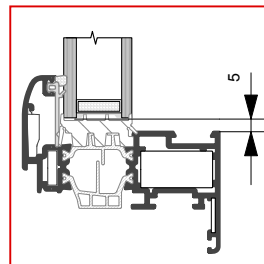

Accessori e guarnizioni

Codice	Descrizione	Q.ta	Codice	Descrizione	Q.ta
ACX.01.SQ	Squadretta a pulsante	8	ARX.05.01	Copriasoia scarico acqua	2
ARX.03.SQ	Squadretta cianfrinare est.	8	ARX.06.01	Espansore	*
ARX.15.SQ	Squadretta allin. telaio/anta	8	ARX.10.61	Guarnizione precamera	2L,2H
ARX.10.SQ	Squadretta allin. anta int.	4	ACX.10.04	Guarnizione battuta	2L,2H
ACX.02.01	Cerniera a 2 ali	3	ARX.10.05.1	Guarnizione vetro esterna	4L,2H
ARX.03.06	Cremonese pressofusa	1	*	Guarnizione vetro interna	4L,2H
ACX.03.17	Innesti cremonese	2	ARX.10.62	Angolo guarn. precamera	4
ACX.03.18	Terminale astina	2	ACX.10.71	Guarn. sostegno fermavetro	
ACX.03.13	Ferrogliera	2	ARX.10.73	Guarnizione sottovetro	4L,2H

* secondo dimensioni

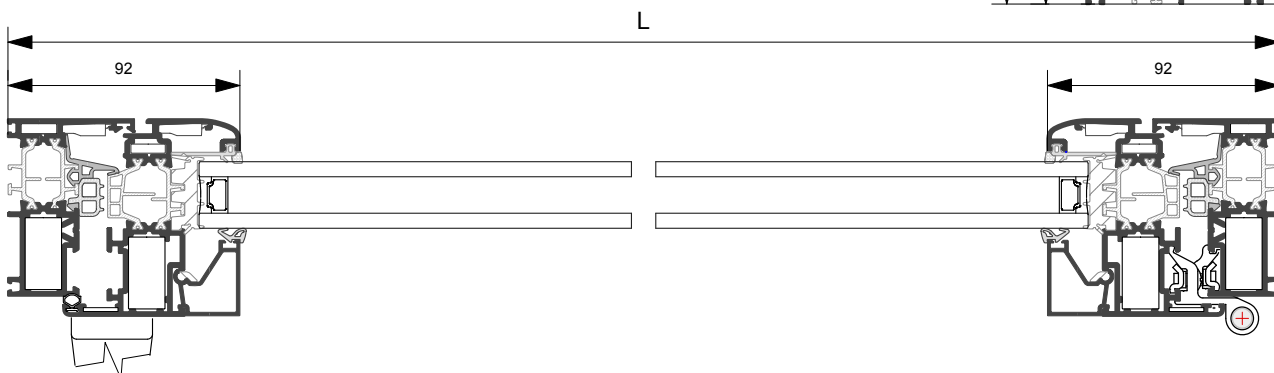

Profilo	Taglio	Q.ta	Profilo	Taglio	Q.ta	Profilo	Taglio	Q.ta
CX70.101HP	L	2	CX70.566	L - 184	4	CX70.402HP	L - 130	1
	H	2		H - HF - 92	2			
CX70.201HP	L - 44	2		HF - 188	2			
	H - 44	2	CX70.605					

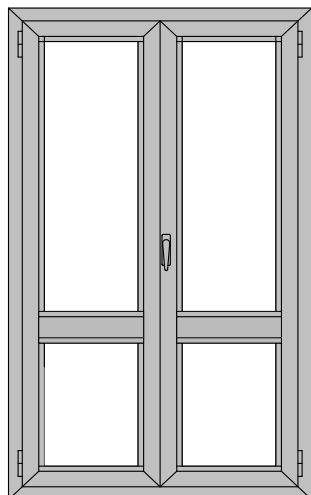

Porta a 2 ante

Distinta di taglio vetri		
Q.tà	H	L
1	H-HF-58	L/2 -130
1	HF -154	L/2 -130

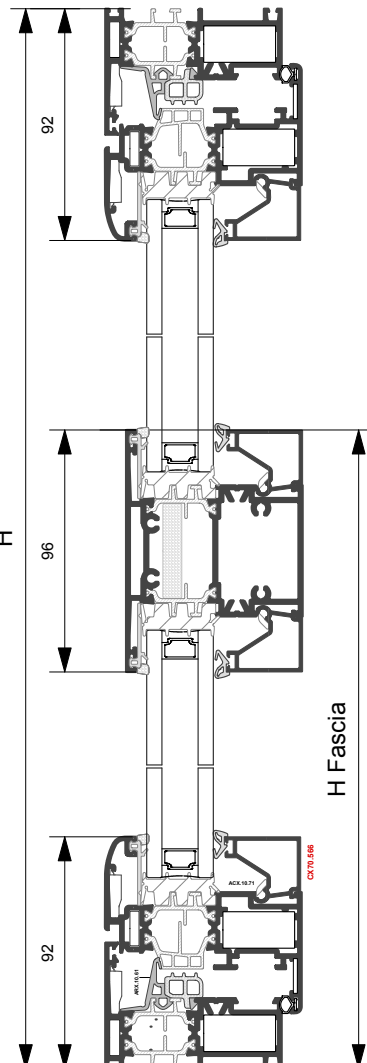
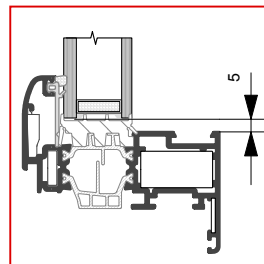

Accessori e guarnizioni

Codice	Descrizione	Q.ta	Codice	Descrizione	Q.ta
ACX.01.SQ	Squadretta a pulsante	12	ACX.04.01	Tappo riporto centrale	1
ARX.03.SQ	Squadretta cianfrinare est.	12	ARX.05.01	Copriasta scarico acqua	2
ARX.15.SQ	Squadretta allin. telaio/anta	12	ARX.06.01	Espansore	*
ARX.10.SQ	Squadretta allin. anta int.	8	ARX.10.61	Guarnizione precamera	2L,3H
ACX.02.01	Cerniera a 2 ali	6	ACX.10.04	Guarnizione battuta	2L,4H
ARX.03.06	Cremonese pressofusa	1	ARX.10.05.1	Guarnizione vetro esterna	4L,4H
ACX.03.17	Innesti cremonese	2	*	Guarnizione vetro interna	4L,4H
ACX.03.18	Teminale astina	2	ARX.10.62	Angolo guarn. precamera	4
ACX.03.11	Paletto a spinta	2	ACX.10.71	Guarn. sostegno fermavetro	
ACX.03.14	Ferrogliera	2	ARX.10.73	Guarnizione sottovetro	4L,4H

* secondo dimensioni

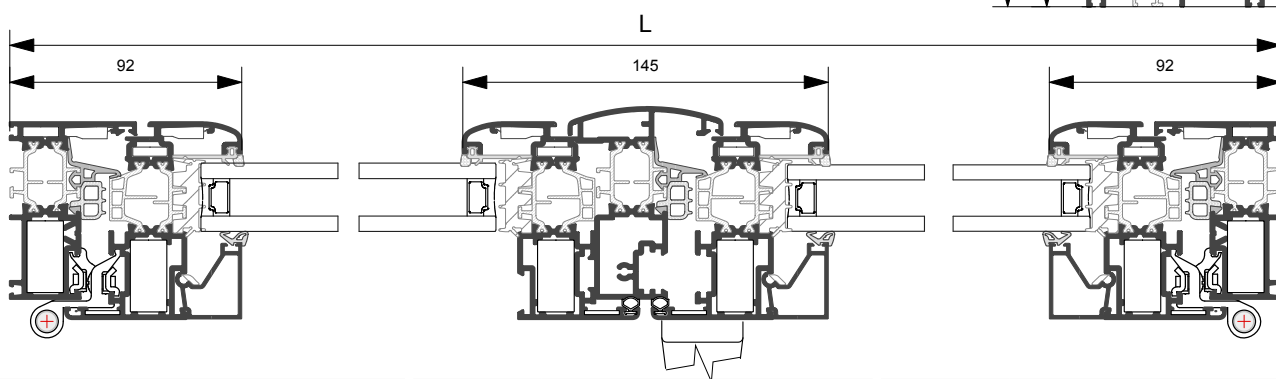

Profilo	Taglio	Q.ta	Profilo	Taglio	Q.ta	Profilo	Taglio	Q.ta
CX70.101HP	L	2	CX70.566	L/2 - 164.5	8	CX70.301HP	H - 110	1
	H	2		H - HF - 92	4			
CX70.201HP	L/2 - 24.5	4		HF - 188	4	CX70.402HP	L/2 - 110.5	2
	H - 44	2	CX70.605		1			

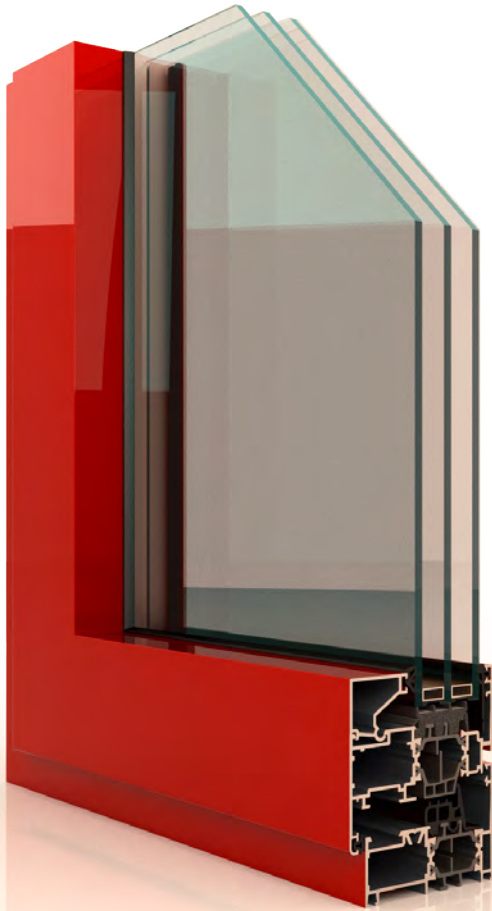

Collegamento
Muratura

Gruppo F



FISSAGGIO ALLA MURATURA

ARX.06.01	
Descrizione Registro Universale	

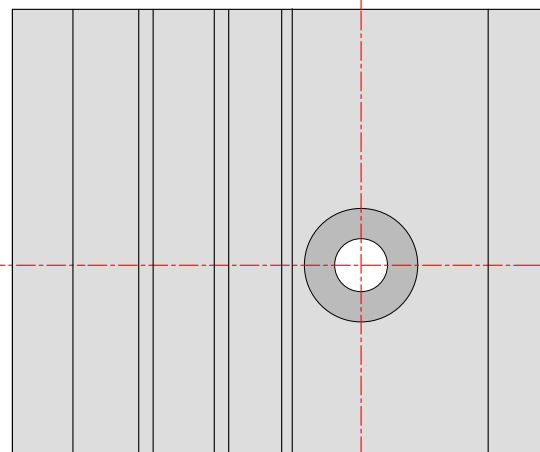
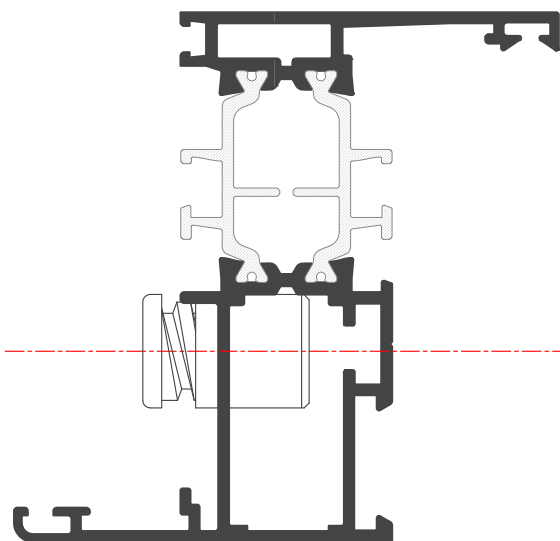
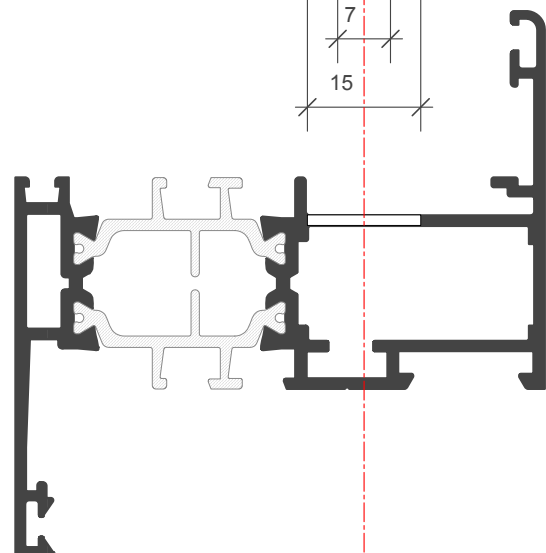
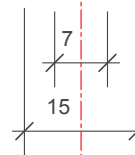
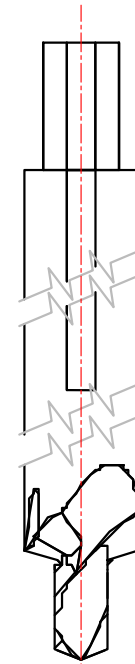



FISSAGGIO ALLA MURATURA

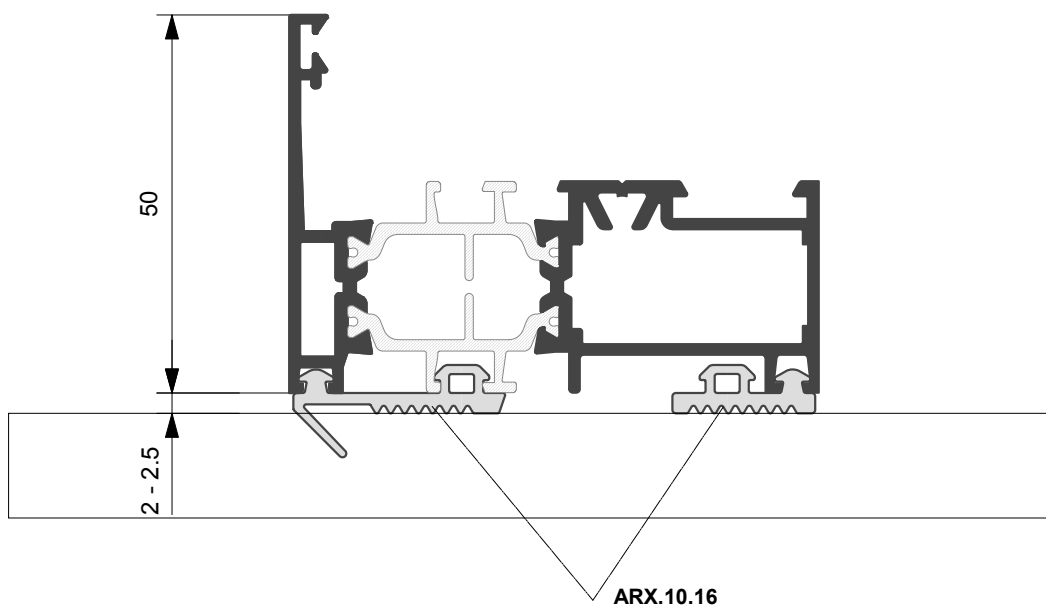
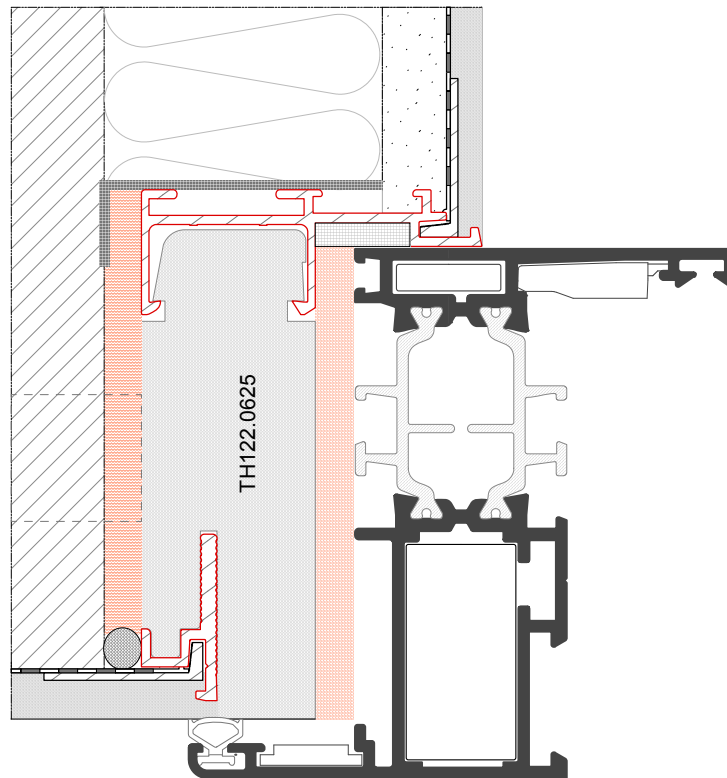

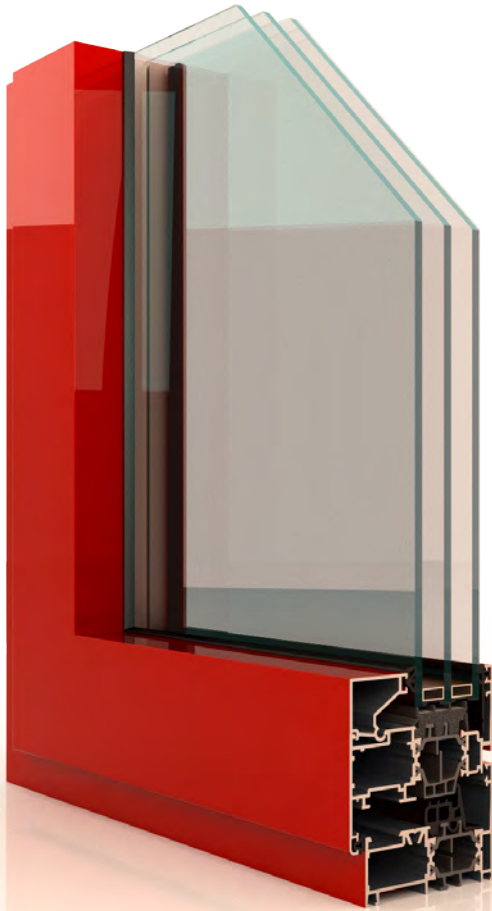

Lavorazioni

Gruppo G

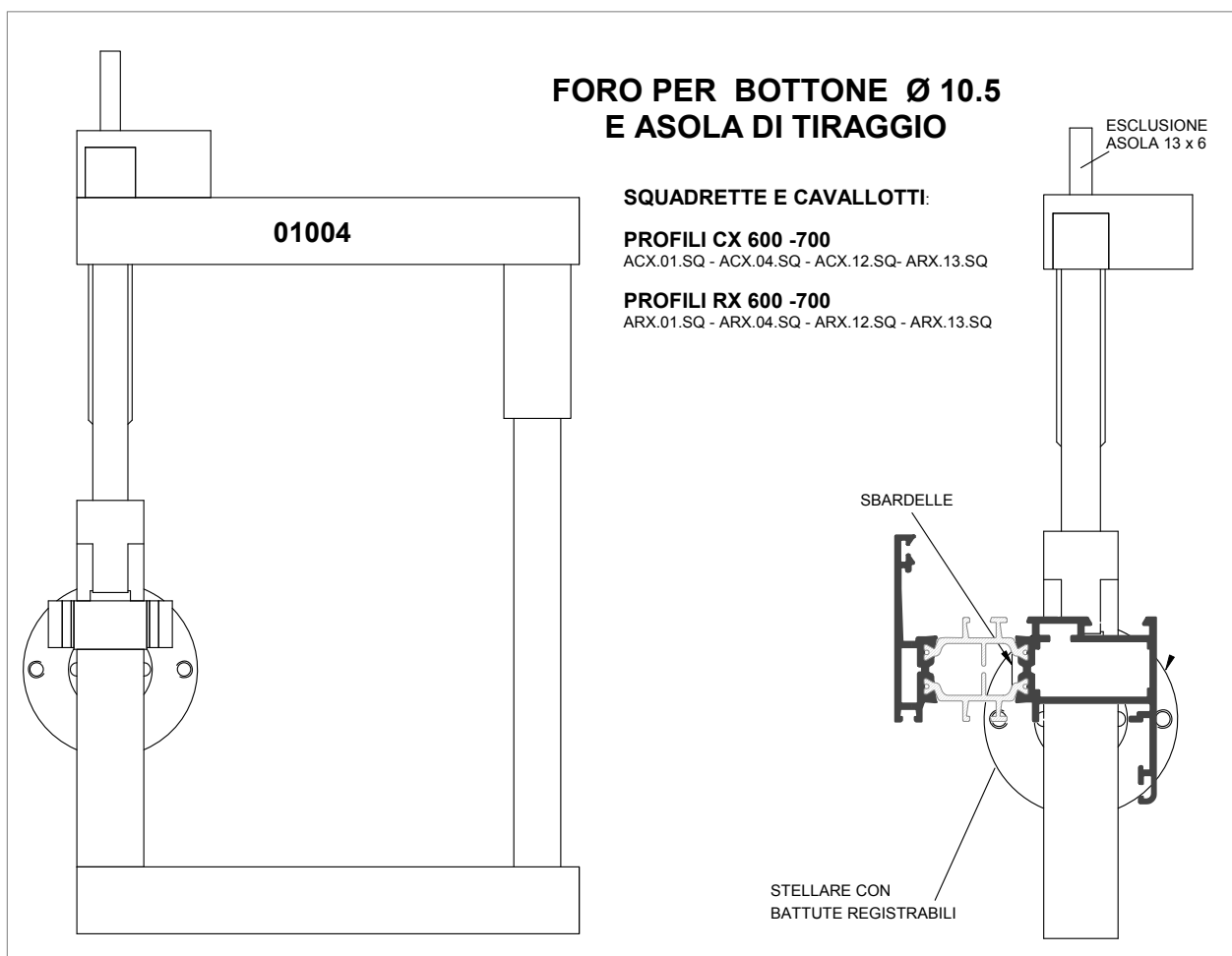
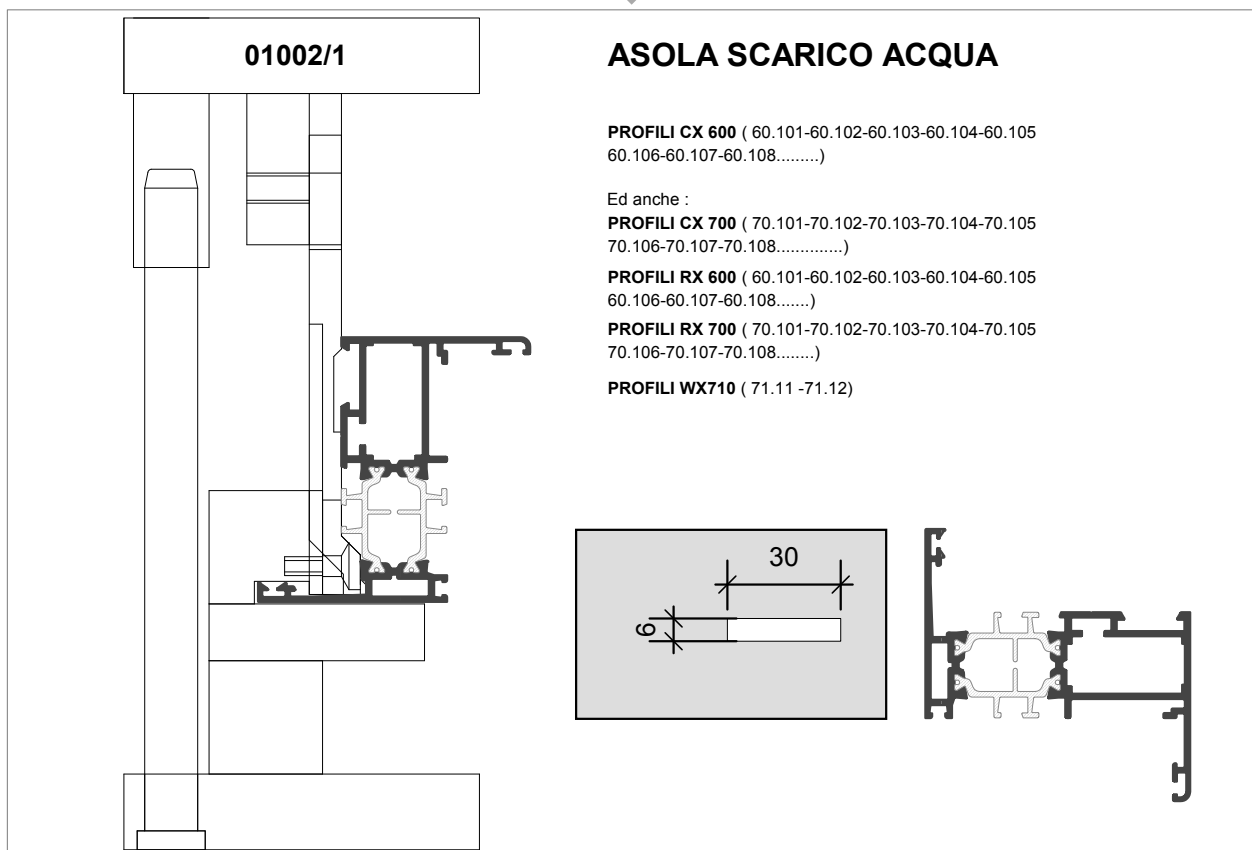

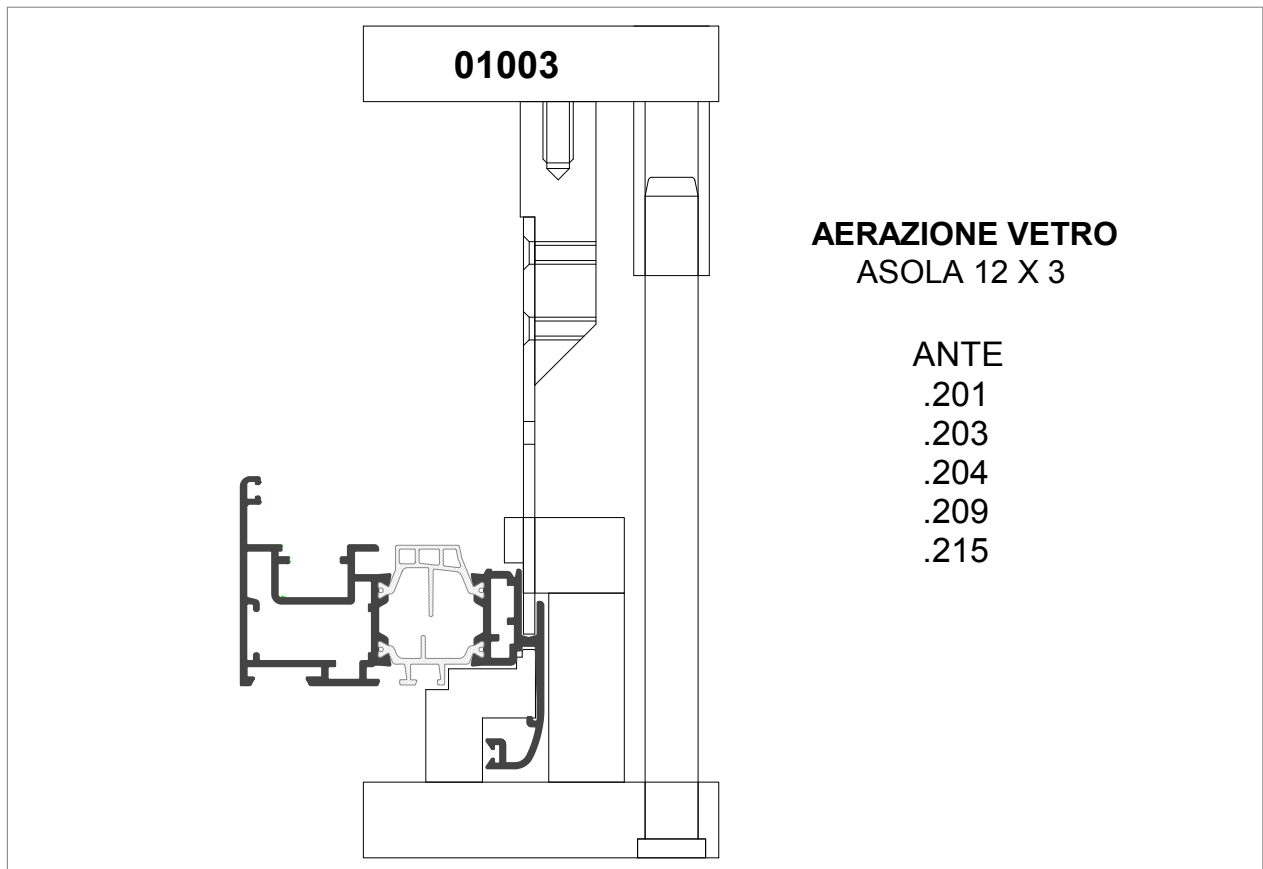
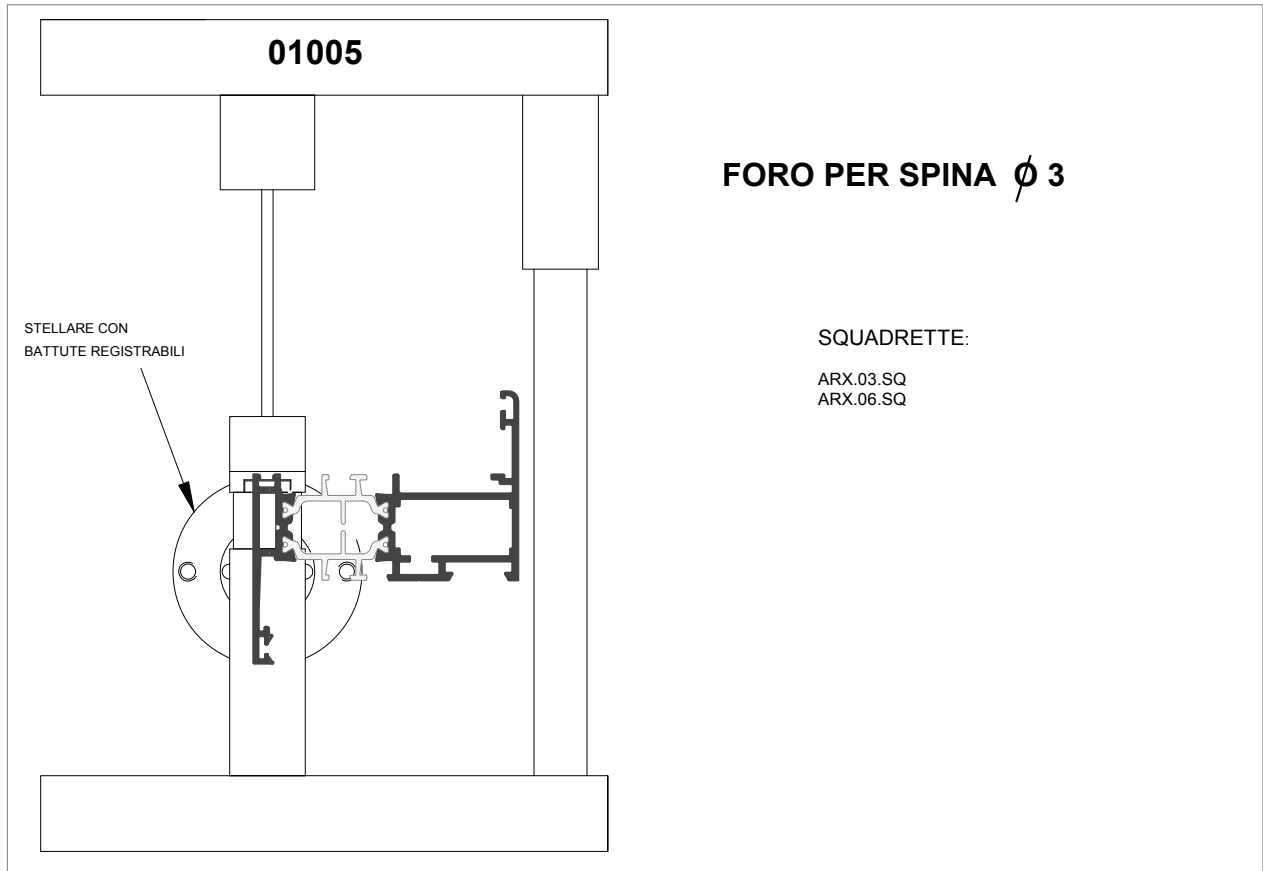

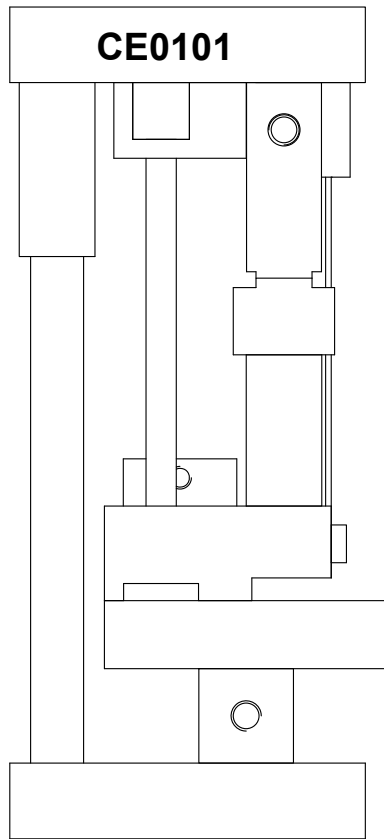

LAVORAZIONI

- LAVORAZIONE CREMONESE DA 104mm
- FORO Ø8 DI TESTA E PASSANTE, DOPPIO FORO DA Ø8 SU ASTINA
- ASPORTAZIONE DENTINI PASSAGGIO ASTA

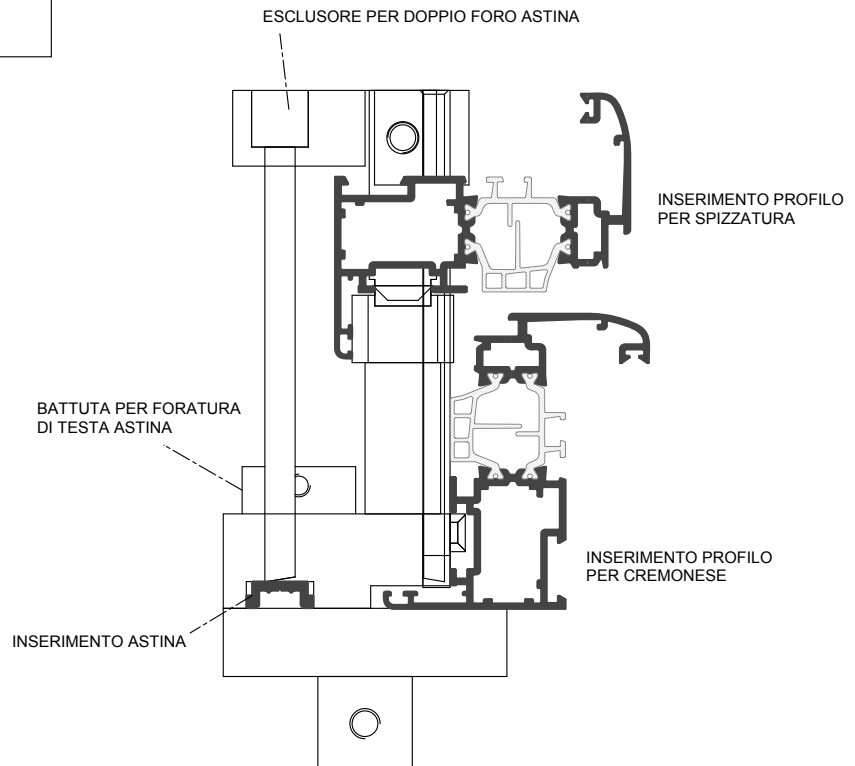

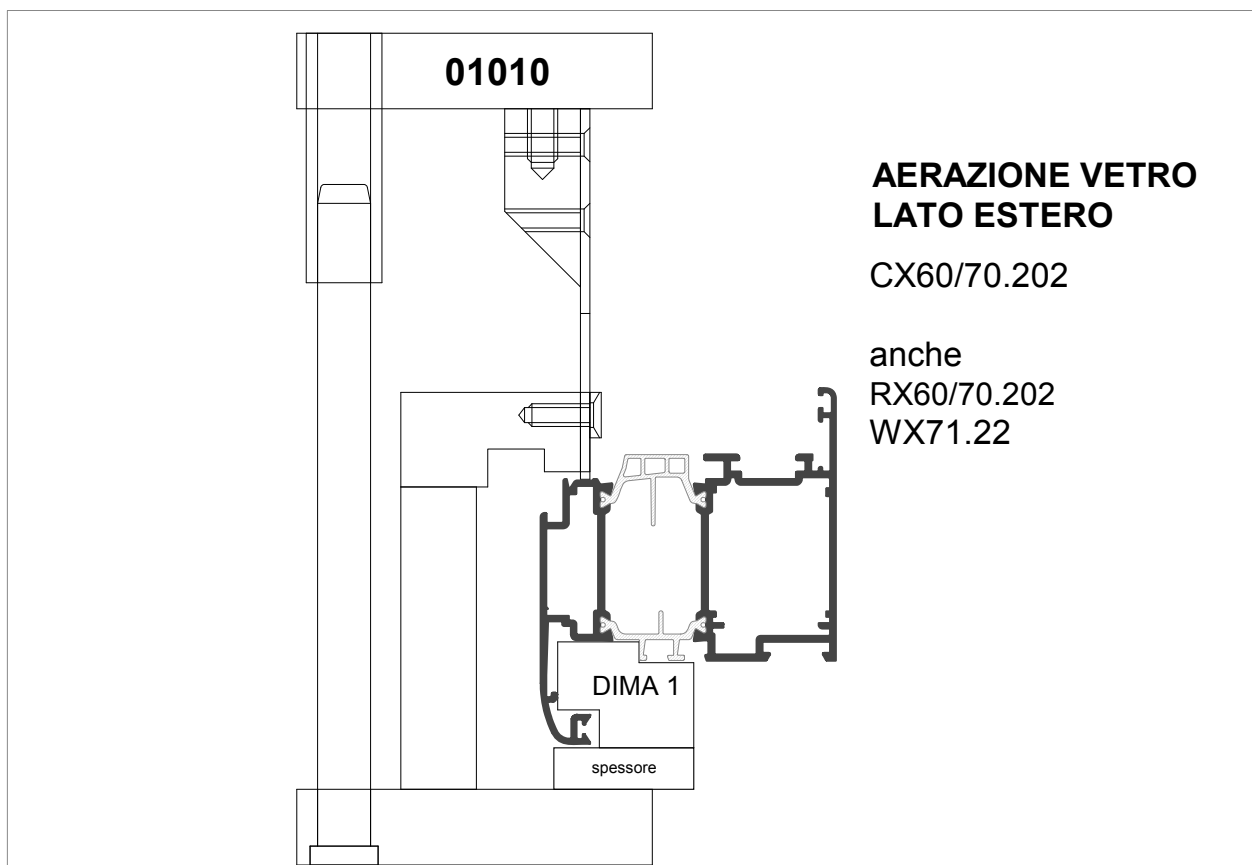
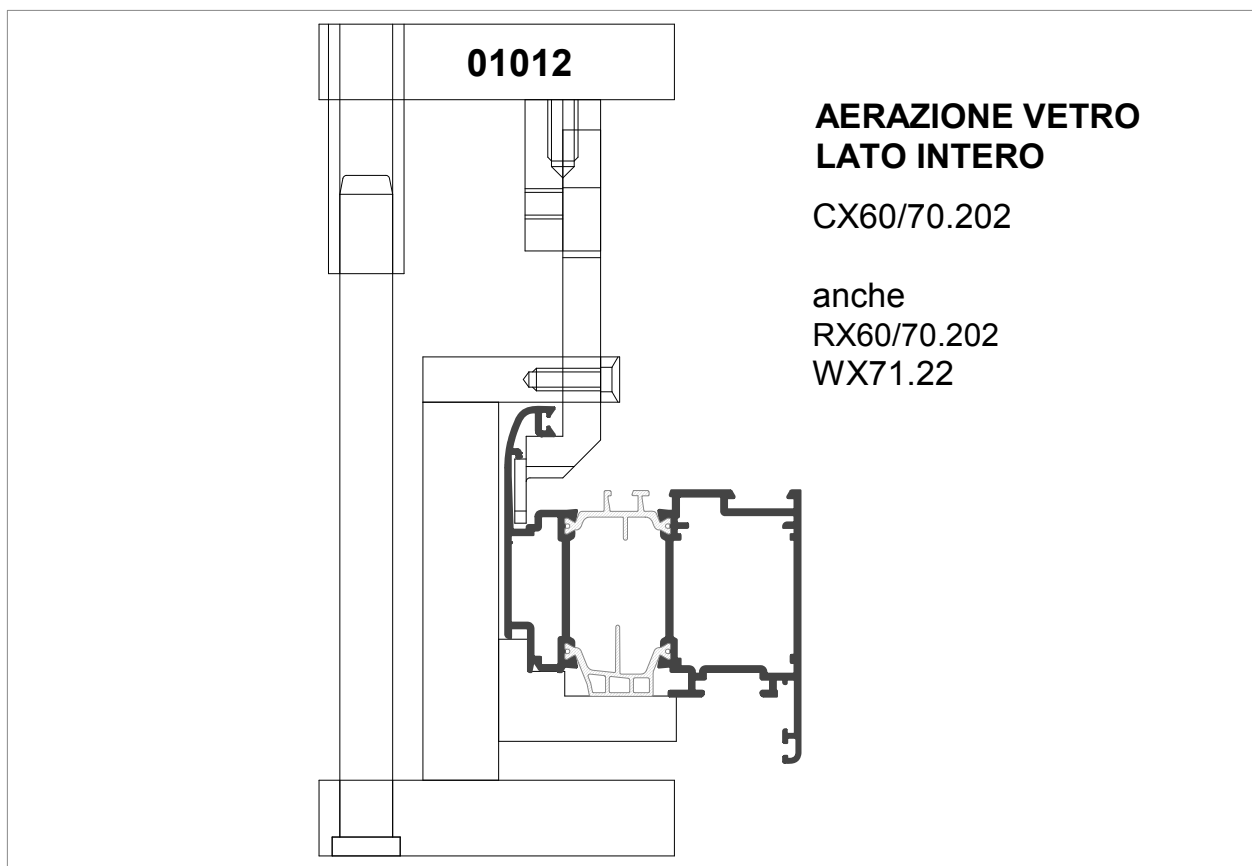

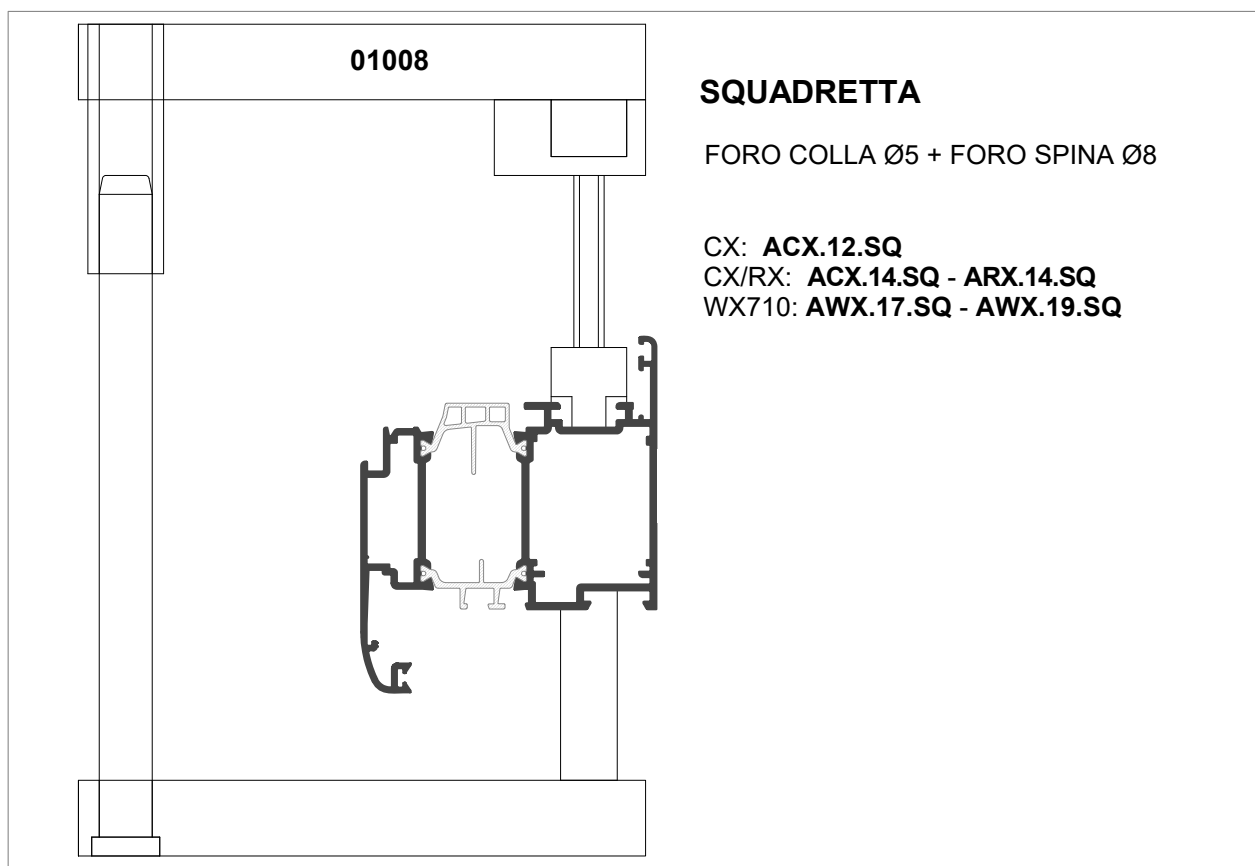

SQUADRETTA

FORO COLLA Ø5 + FORO SPINA Ø8

CX: **ACX.12.SQ**

CX/RX: **ACX.14.SQ - ARX.14.SQ**

WX710: **AWX.17.SQ - AWX.19.SQ**

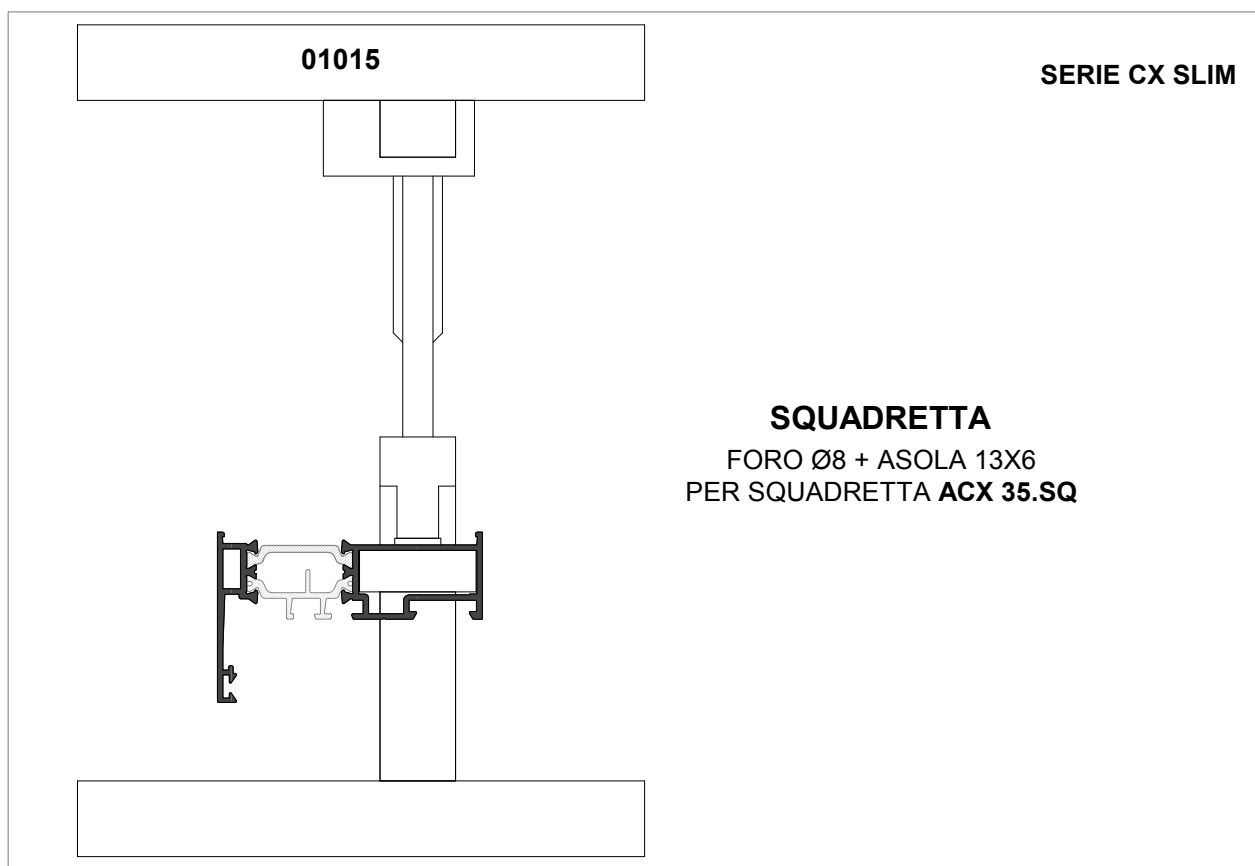

SERIE CX SLIM

SQUADRETTA

FORO Ø8 + ASOLA 13X6
PER SQUADRETTA **ACX 35.SQ**

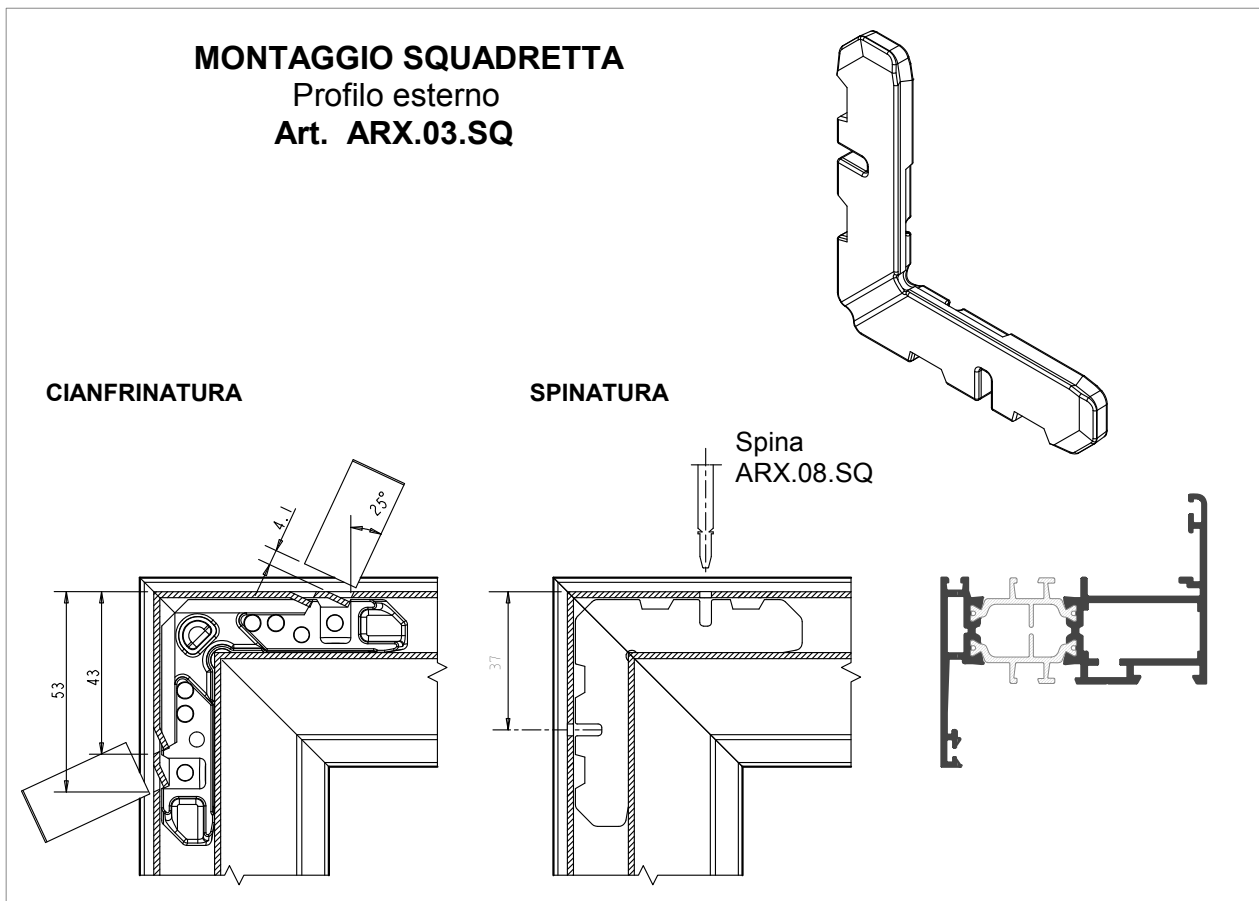
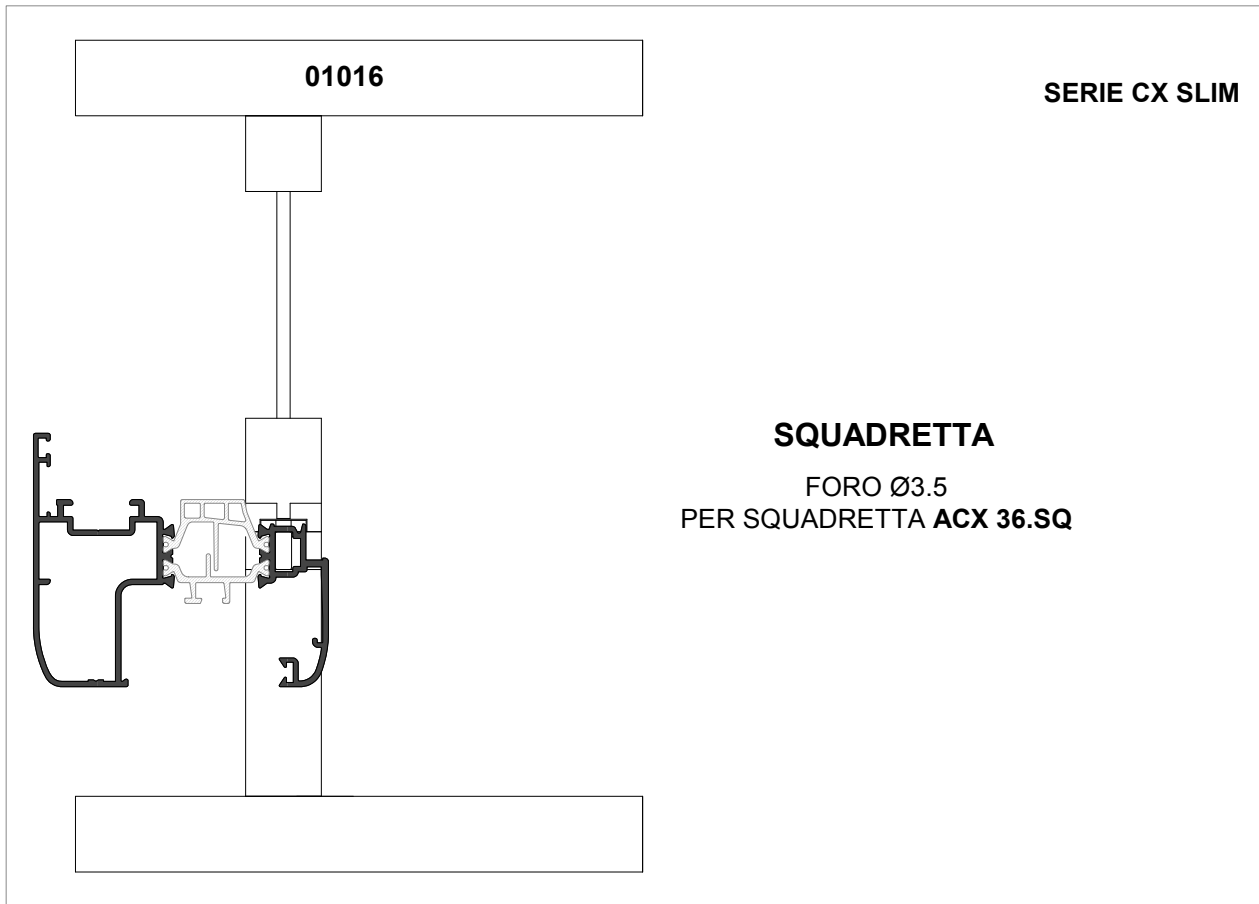



MONTAGGIO SQUADRETTA
Profilo esterno
Art. ARX.06.SQ

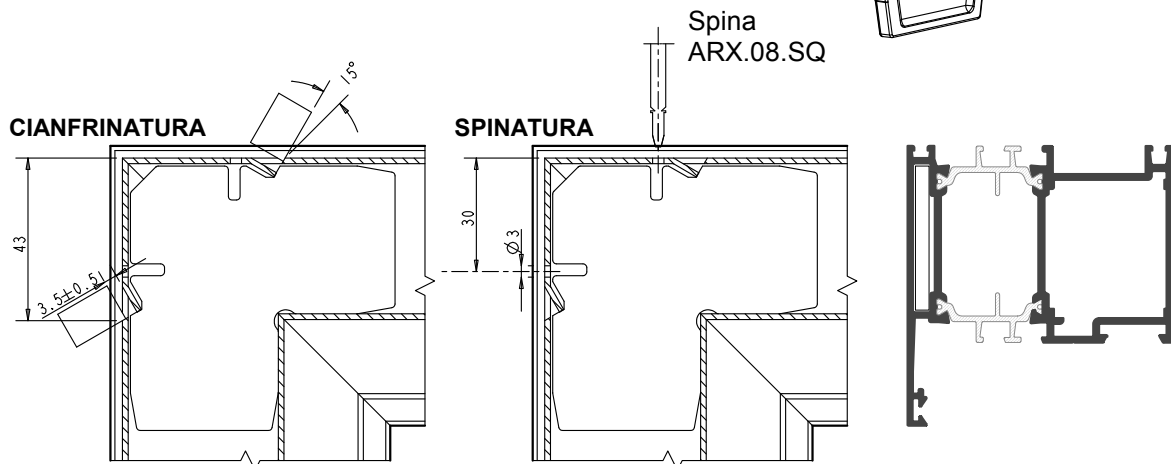

MONTAGGIO SQUADRETTA A PULSANTE
Profilo interno
Art. ACX.01.SQ

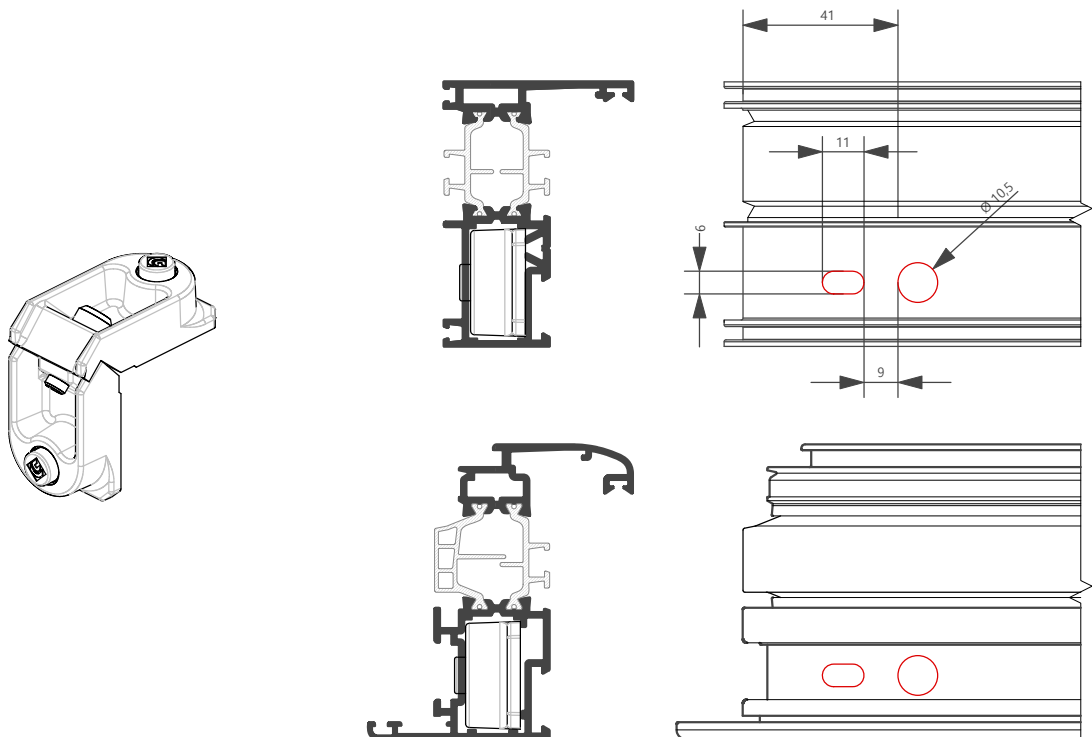



MONTAGGIO SQUADRETTA A PULSANTE

Profilo interno
Art. ARX.13.SQ

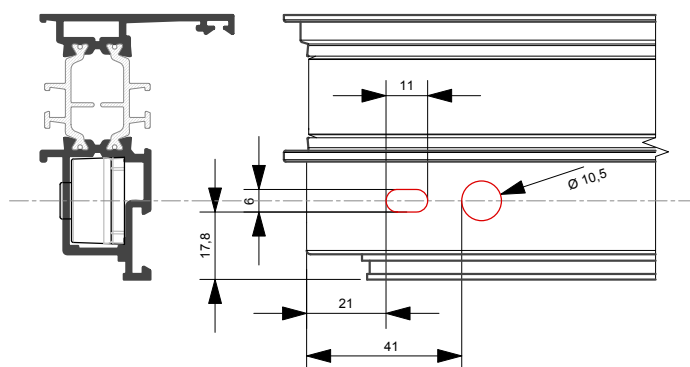
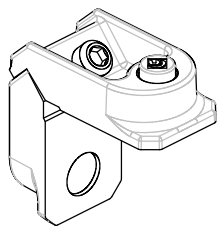

MONTAGGIO SQUADRETTA A PULSANTE

Profilo interno
Art. ACX.04.SQ (Destra e Sinistra)

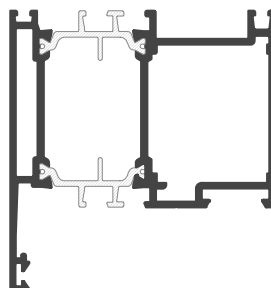
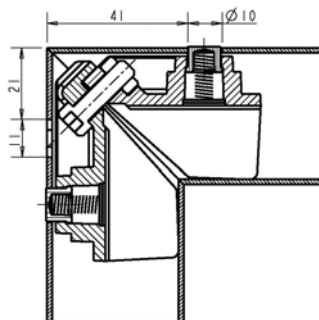
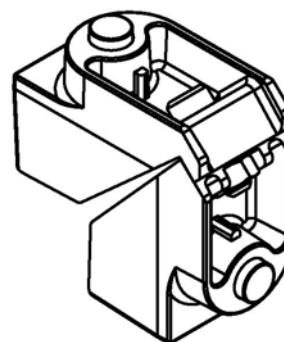

PROFILI :
.105 - .202 e similari



CIANFRINATURA
Coltello 10 mm

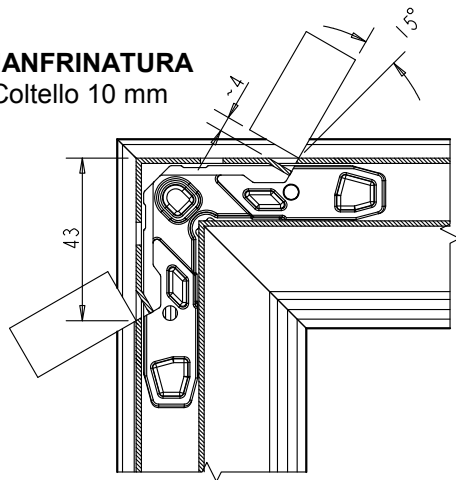

**MONTAGGIO SQUADRETTA
SPINARE, CIANFRINARE ED AVVITARE**

Art. ACX.02.SQ

AVVITATURA
VIL M5X14_D8

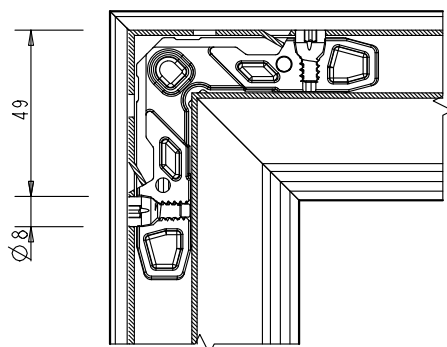

SPINATURA
SPINA ARX.07.SQ [LM0088]

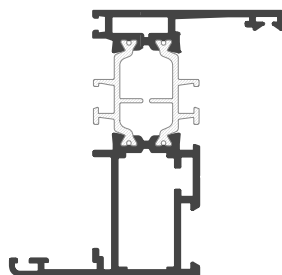
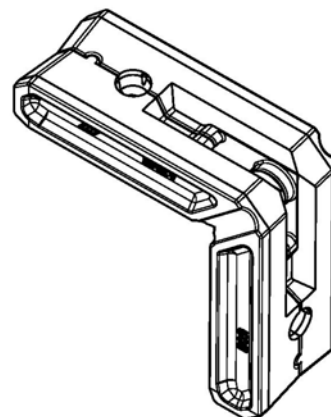
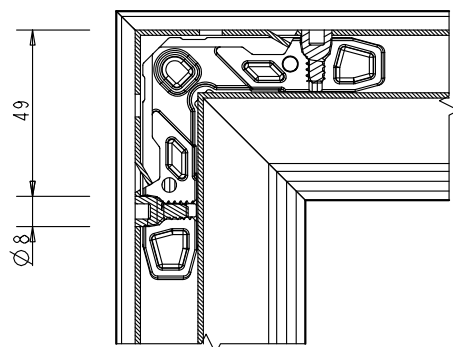

PROFILI :
.101 - .201 e similari



SPINATURA
SPINA ARX.07.SQ
[LM0088]

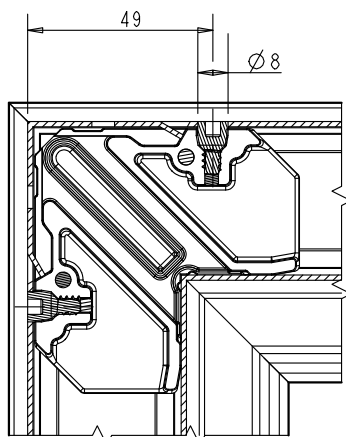

**MONTAGGIO SQUADRETTA
SPINARE, CIANFRINARE ED AVVITARE**

Art. ACX.14.SQ

AVVITATURA
VIL M5X14_D8

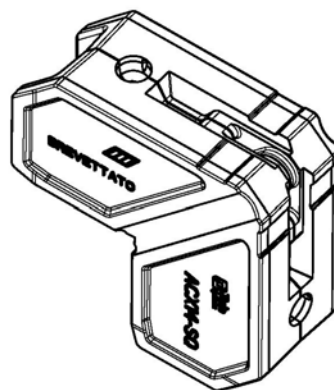
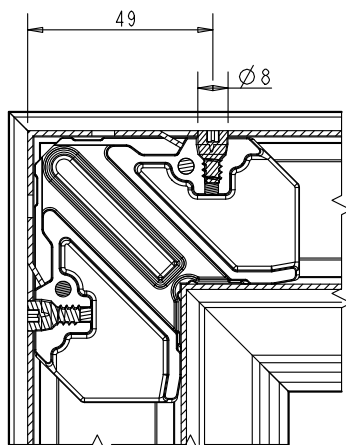

CIANFRINATURA
Coltello 10 mm

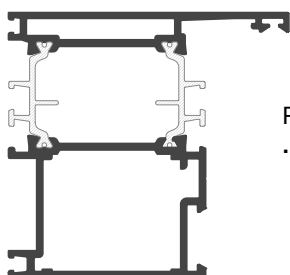
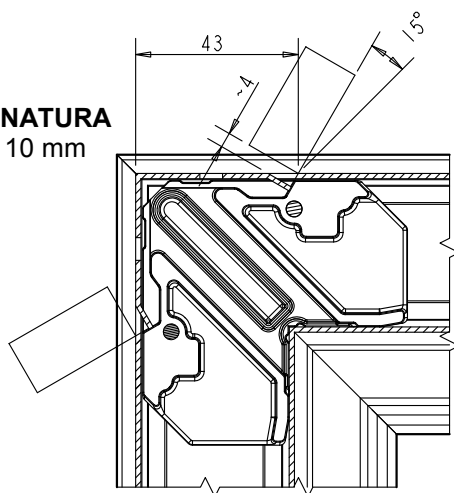

PROFILI :
.105 - .202 e similari



APPLICAZIONE ACCESSORI

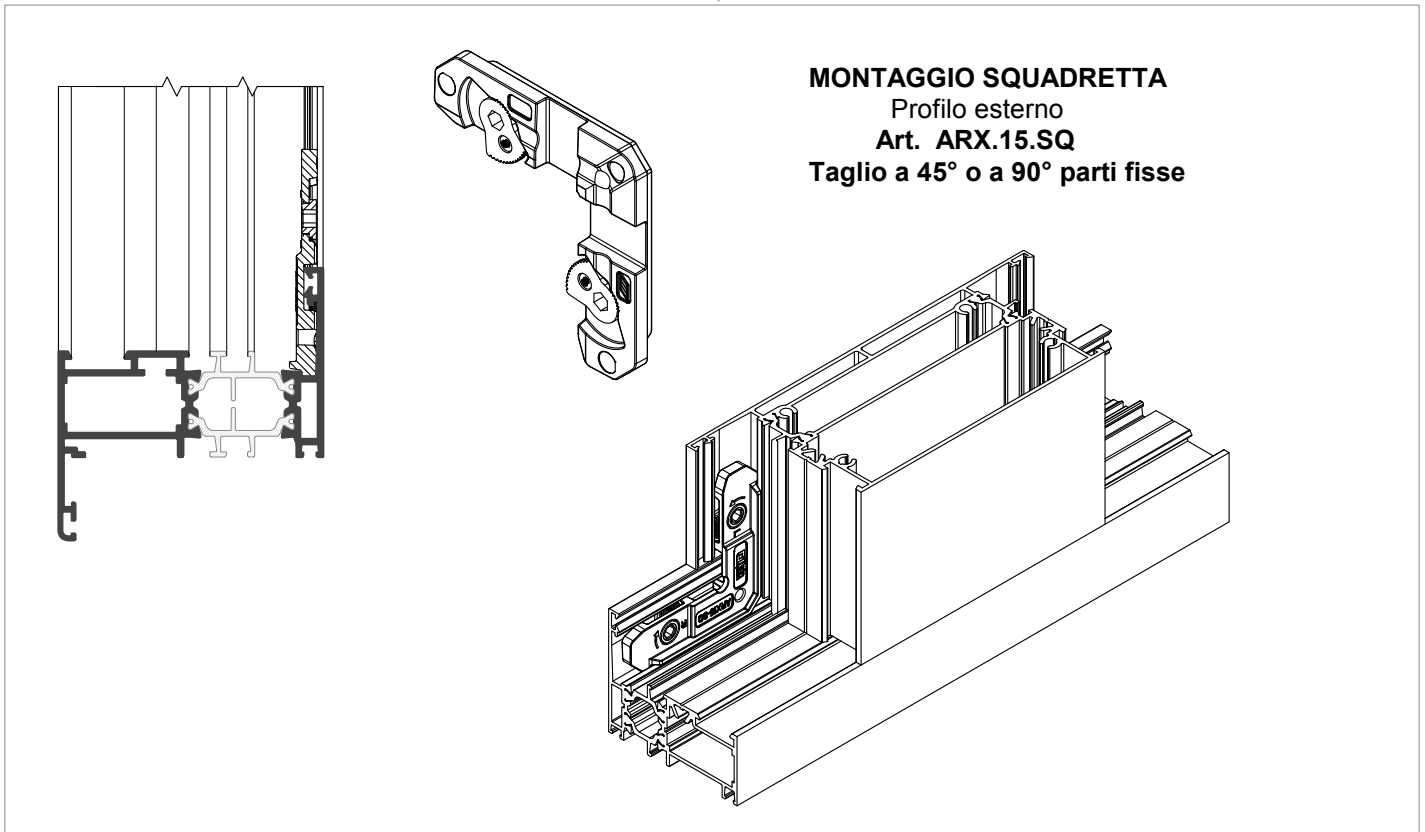

APPLICAZIONE ACCESSORI

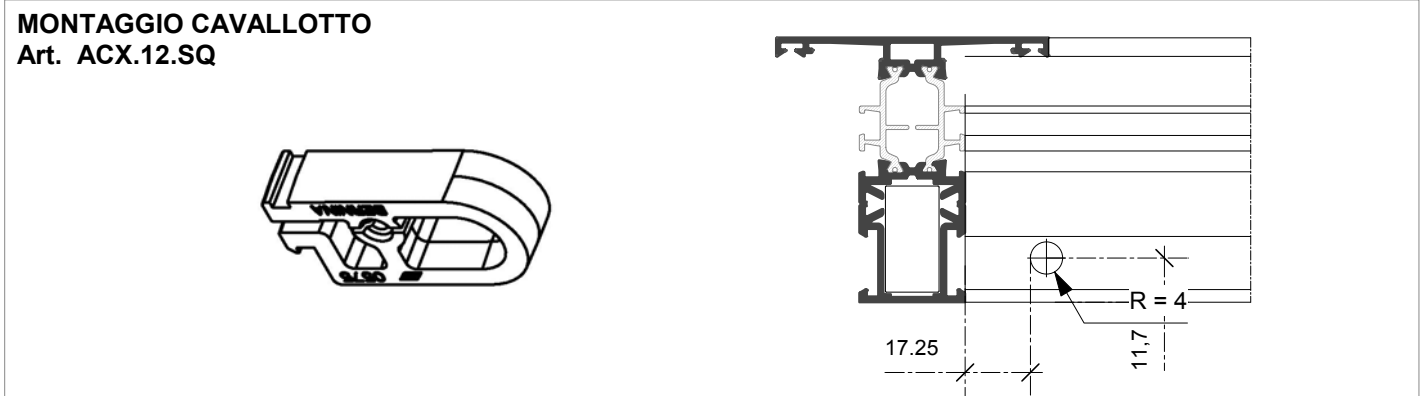

APPLICAZIONE ACCESSORI

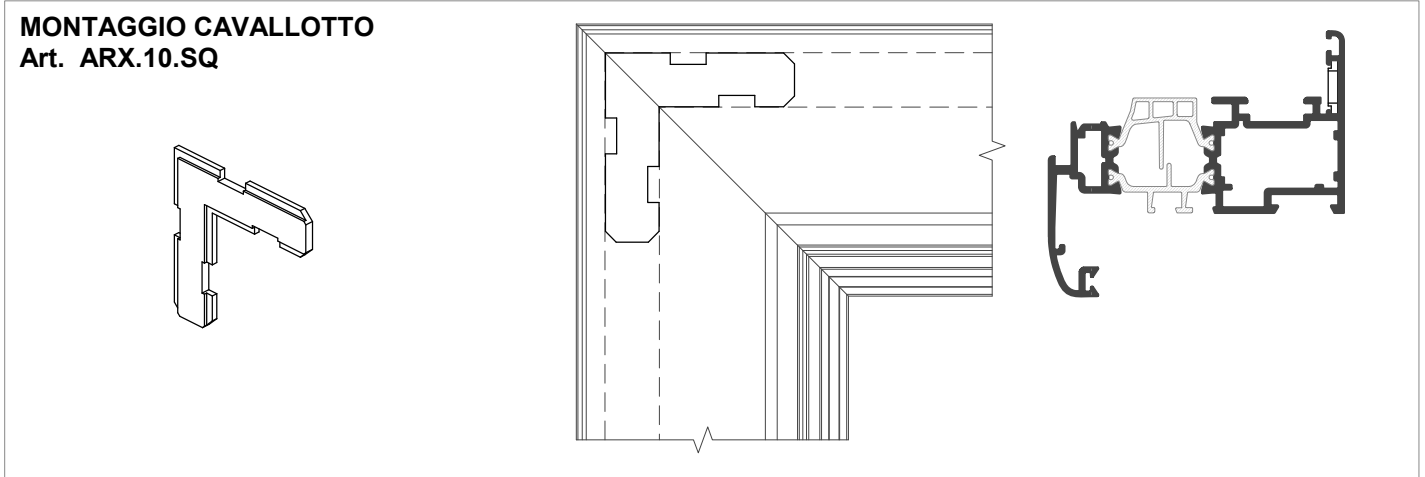



APPLICAZIONE ACCESSORI

MONTAGGIO SQUADRETTA
Art. ARX.11.SQ

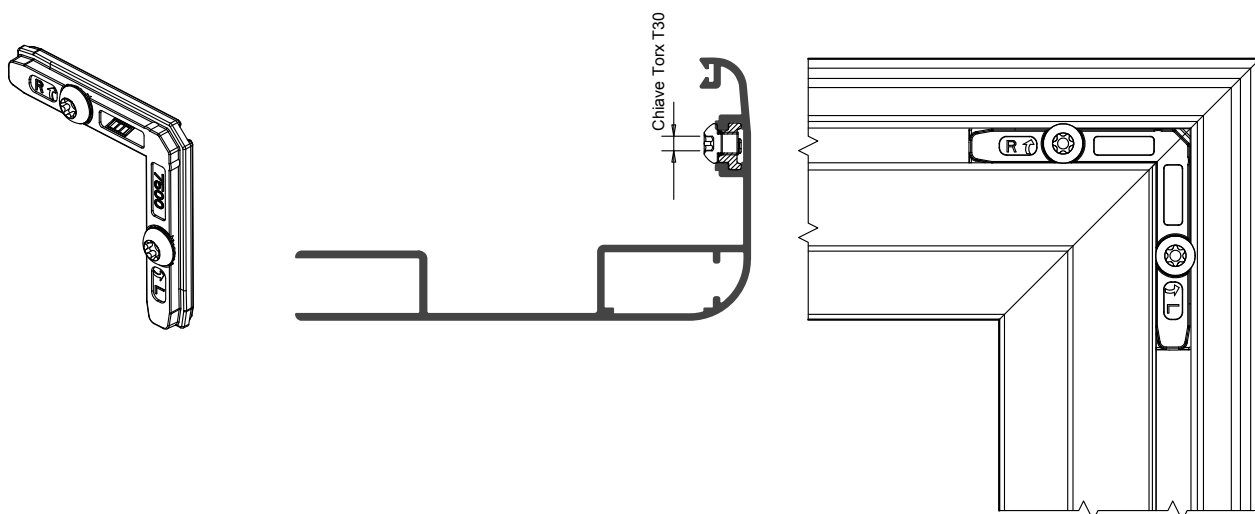

APPLICAZIONE ACCESSORI

**MONTAGGIO SQUADRETTA
IN NYLON**

Art. ARX.24.SQ
(alternativa alla ARX.15.SQ)

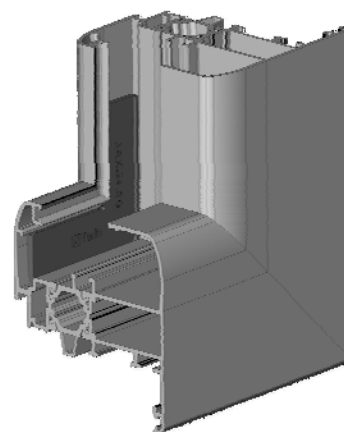

APPLICAZIONE ACCESSORI

GIUNTO PER VETRO AD INFILARE
(Fascia taglio a 90°)
Art. ACX.04.20

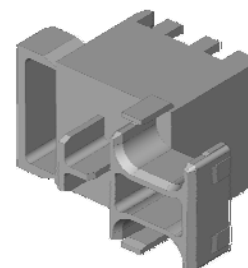
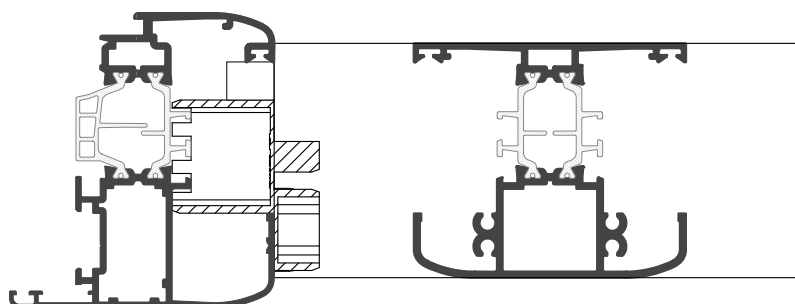



APPLICAZIONE ACCESSORI

ACX.03.12
Terminale asta

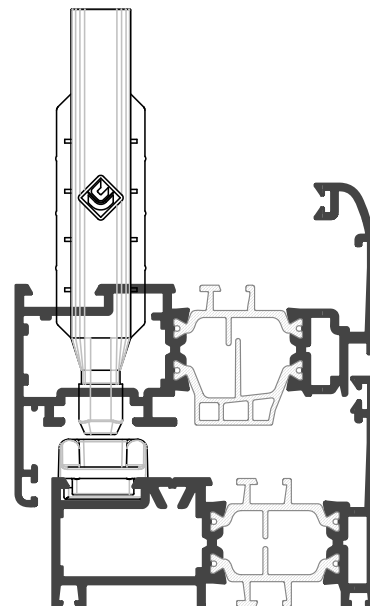
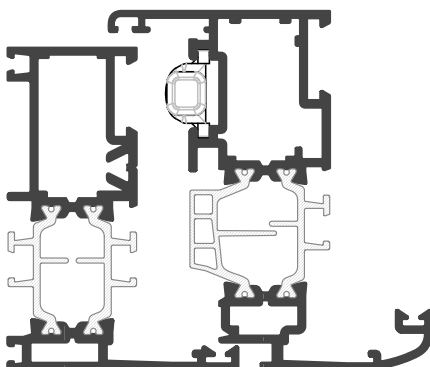

APPLICAZIONE ACCESSORI

ACX.03.18
Terminale asta in zama

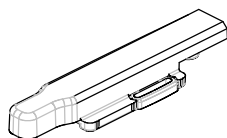

ACX.08.13
Incontro asta
singolo in zama

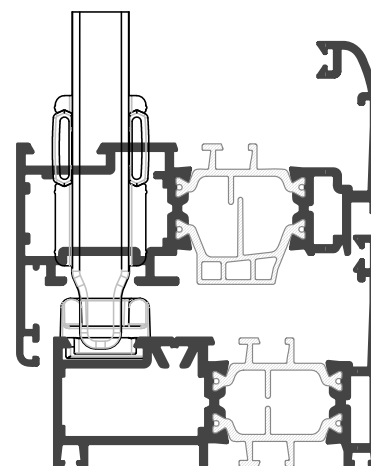
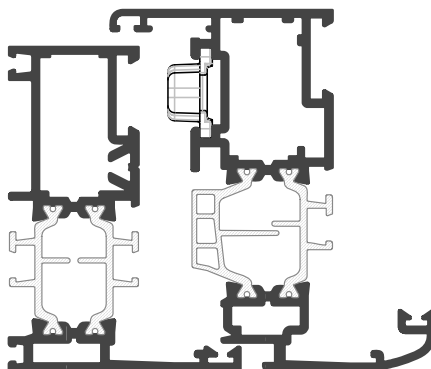
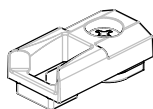



APPLICAZIONE ACCESSORI

ACX.03.11
Catenaccio a leva

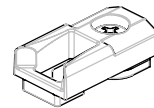
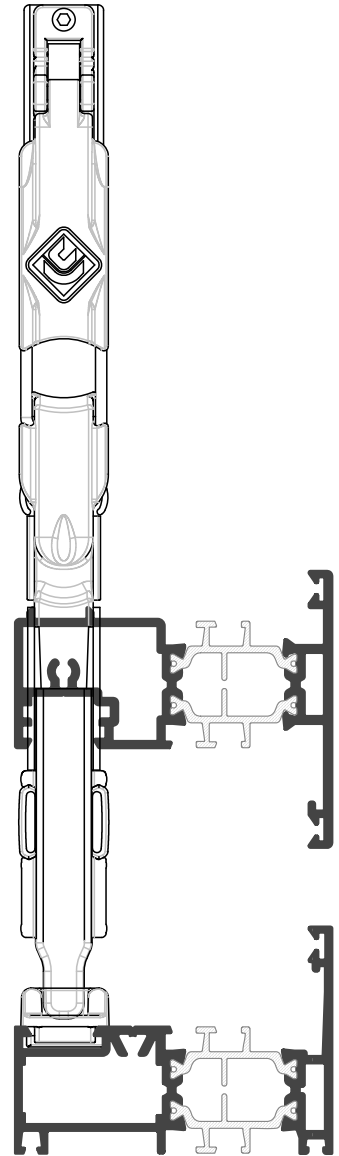
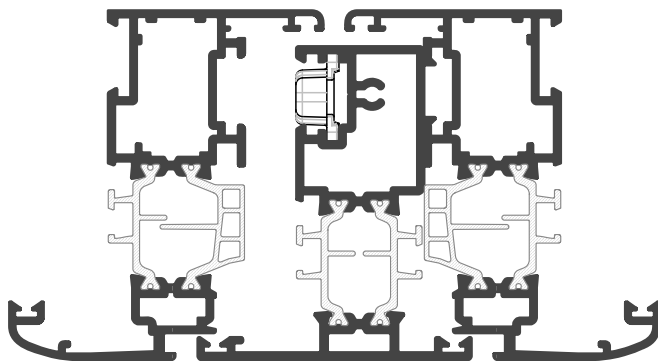
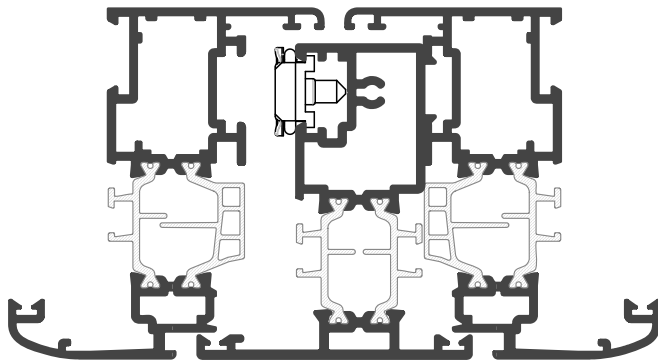
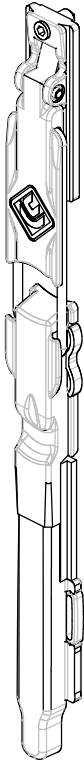

ACX.08.13
Incontro asta



APPLICAZIONE ACCESSORI

ACX.03.16
Kit di chiusura
supplementare
con eccentrico

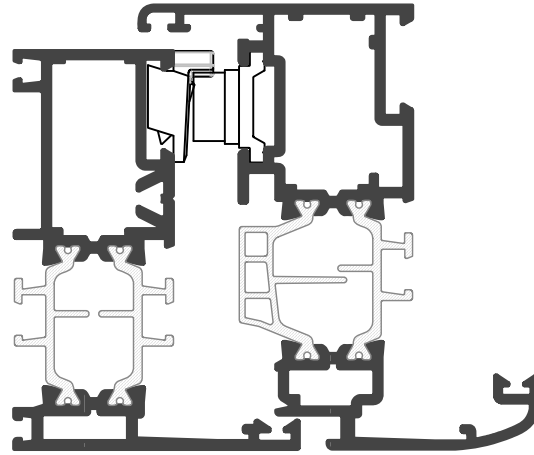
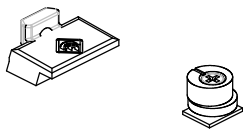

APPLICAZIONE ACCESSORI

ACX.03.63
Incontro a pozzetto d = 8 mm.

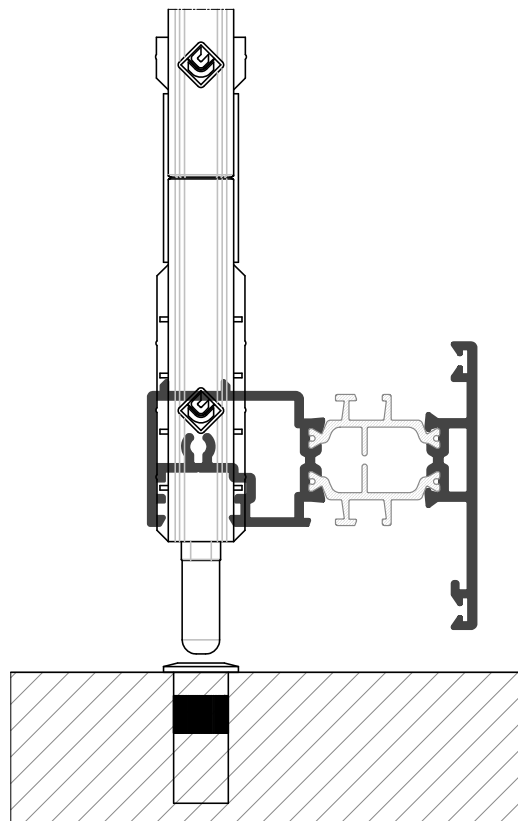
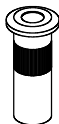



APPLICAZIONE ACCESSORI

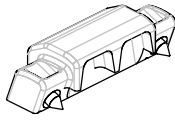

ACX.03.19
Kit sostegno anta

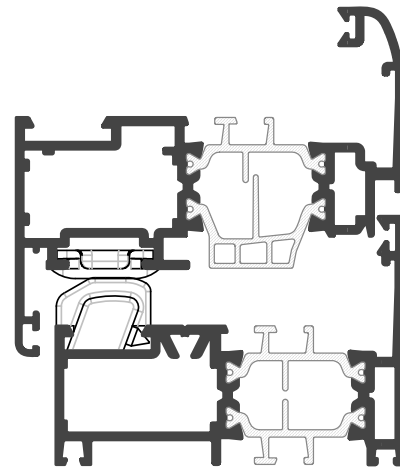
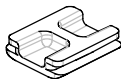

APPLICAZIONE ACCESSORI

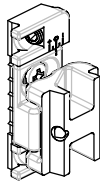

ACX.03.29
Rostro regolabile

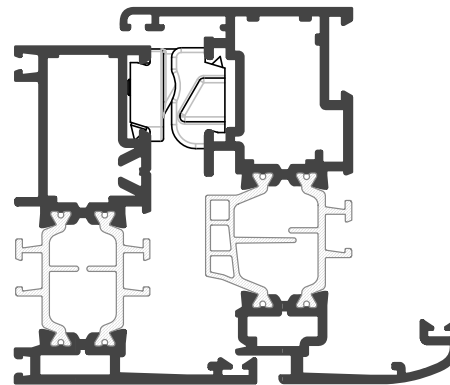

APPLICAZIONE ACCESSORI

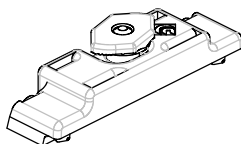

ACX.03.15
Clip ferma anta

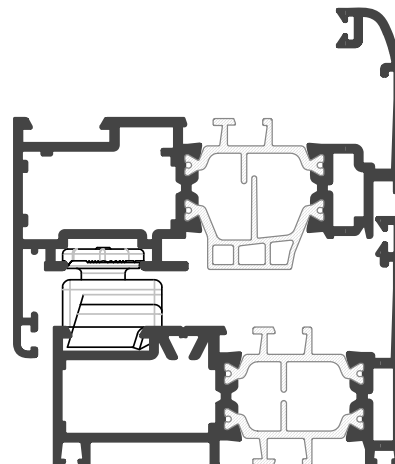



APPLICAZIONE ACCESSORI

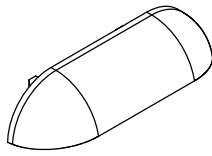

ARX.05.01
Cappetta drenaggio

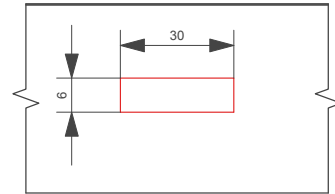
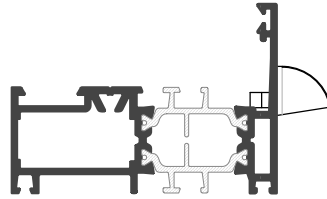

APPLICAZIONE ACCESSORI

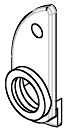

ARX.06.02
Piastrina registro
telaio



ARX.06.03
Registro
telaio mm.20

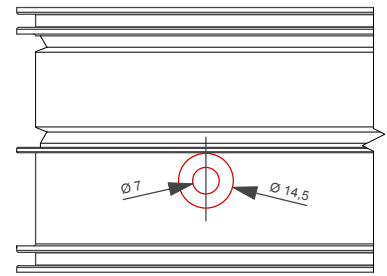
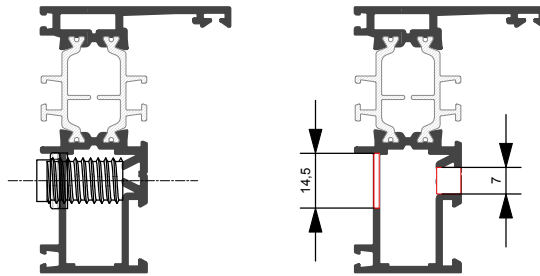

APPLICAZIONE ACCESSORI

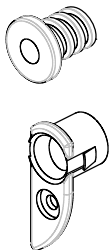

ARX.06.01
Registro
telaio universale

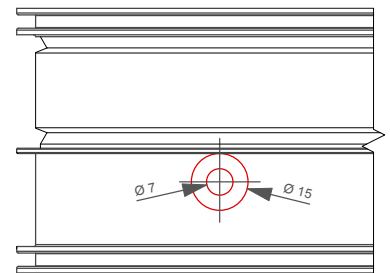
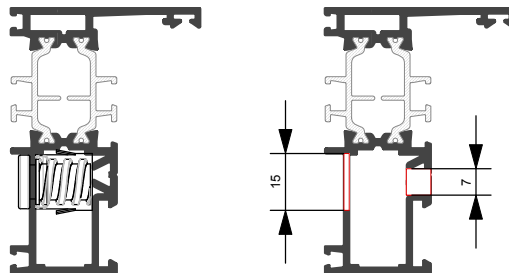



APPLICAZIONE ACCESSORI

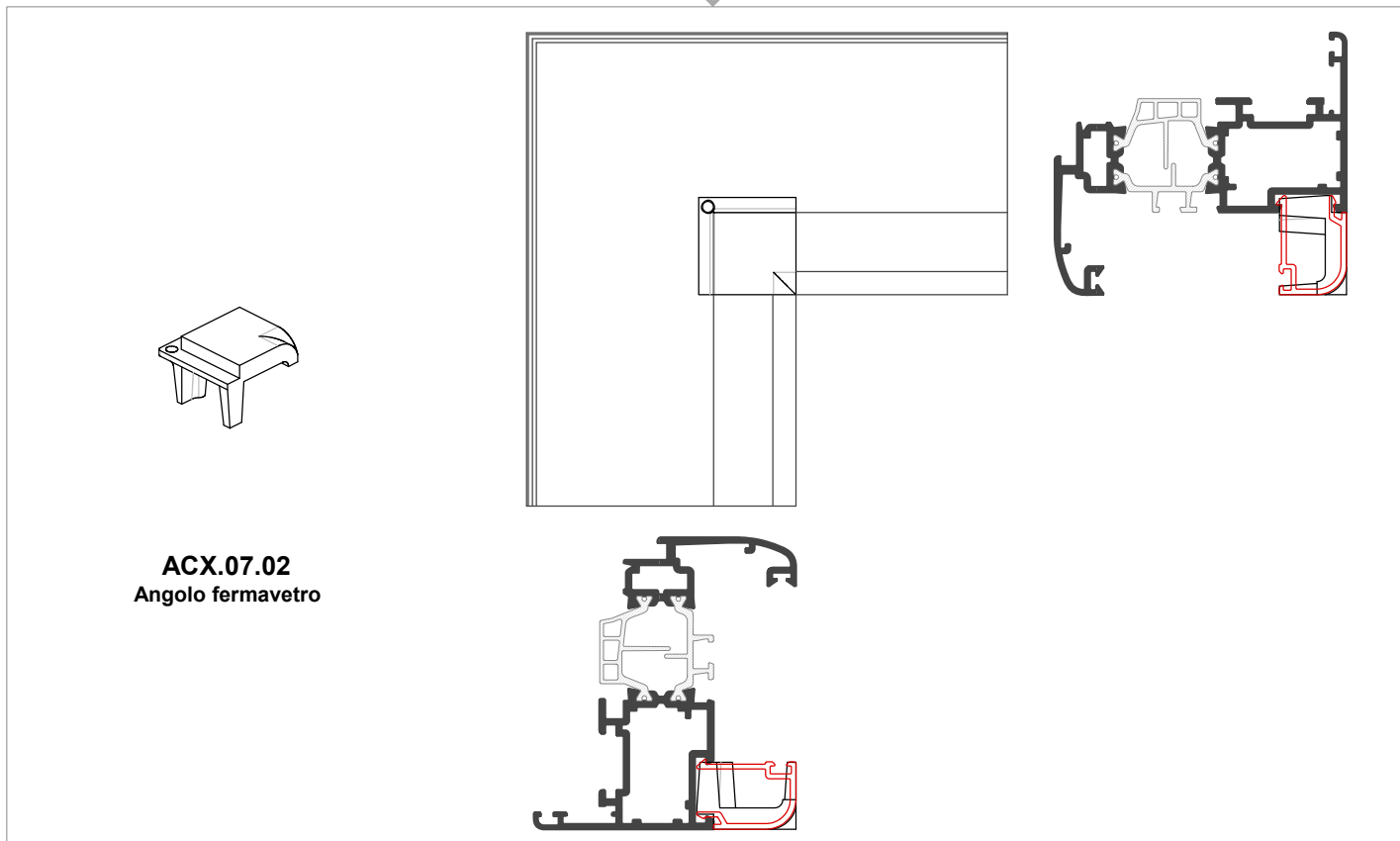

ACX.07.02
Angolo fermavetro

APPLICAZIONE ACCESSORI

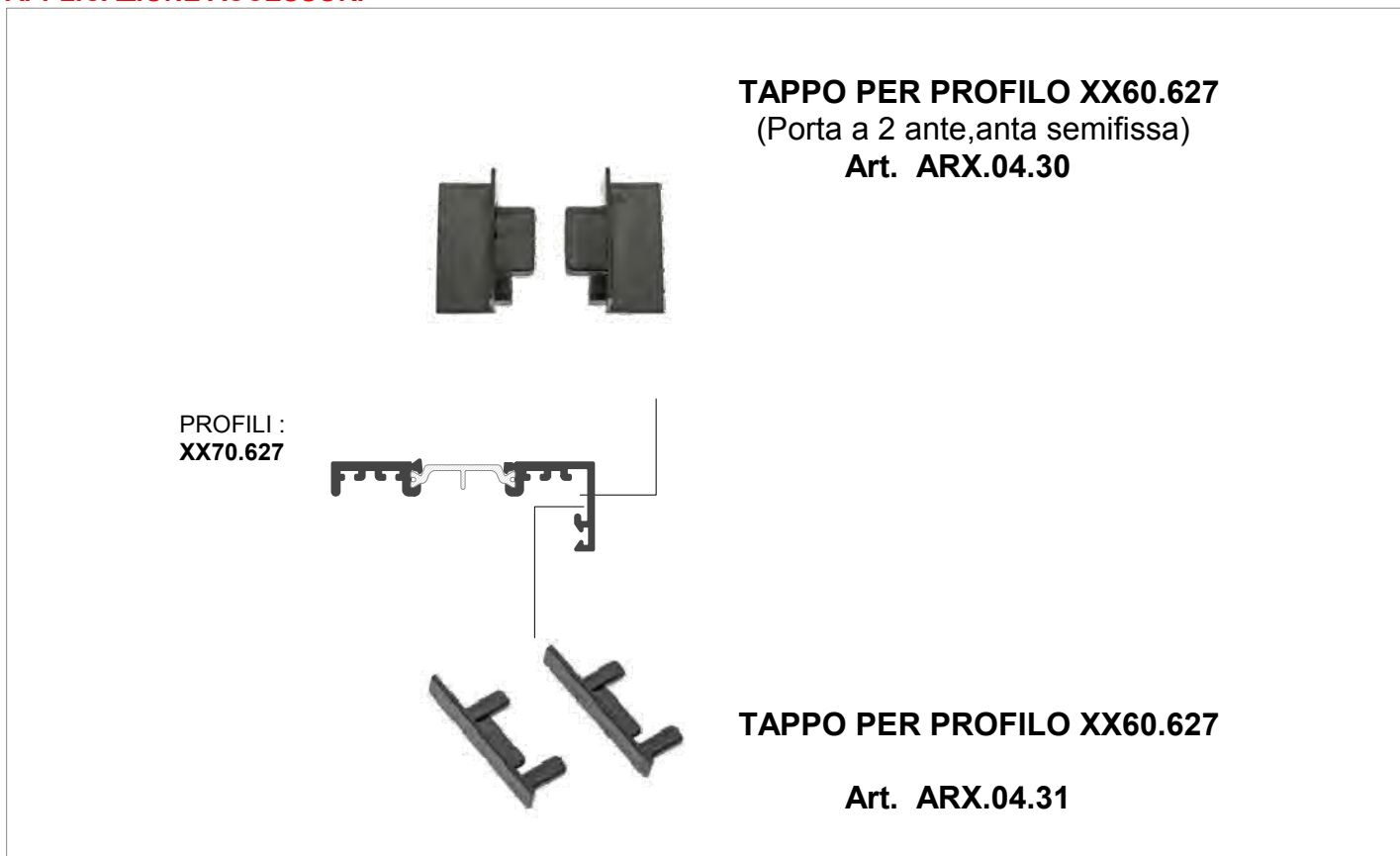

TAPPO PER PROFILO XX60.627
(Porta a 2 ante, anta semifissa)
Art. ARX.04.30

PROFILI :
XX70.627

TAPPO PER PROFILO XX60.627
Art. ARX.04.31



APPLICAZIONE ACCESSORI

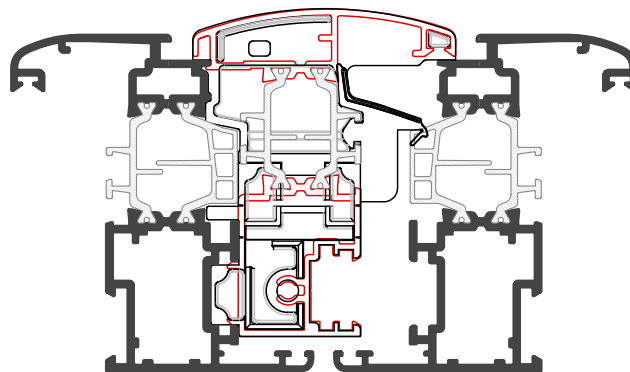
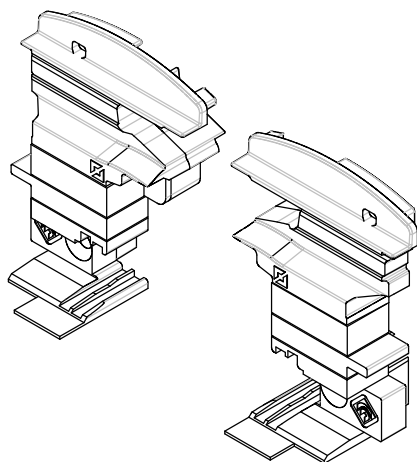

ACX.04.01HP
Coppia tappi
di riporto

APPLICAZIONE ACCESSORI

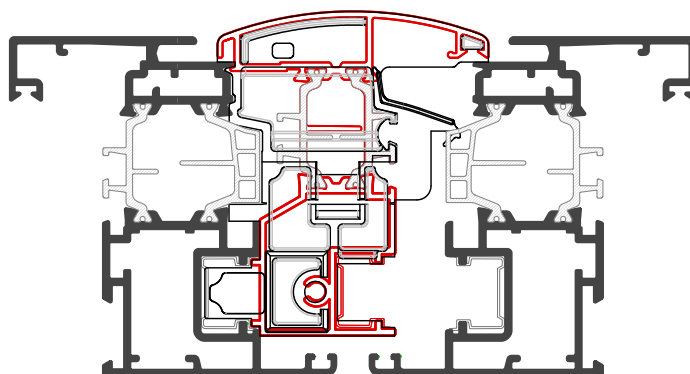
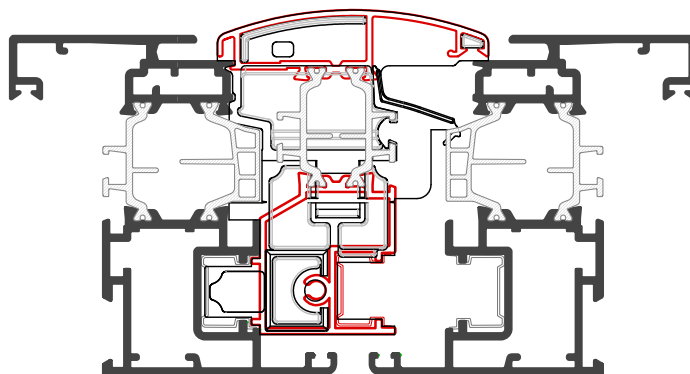
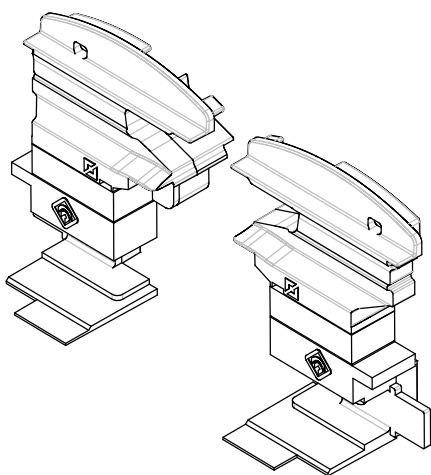

ARX.04.02HP
Coppia tappi
di riporto



APPLICAZIONE ACCESSORI

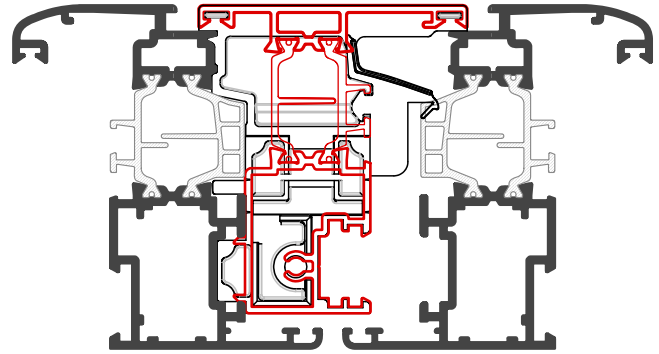
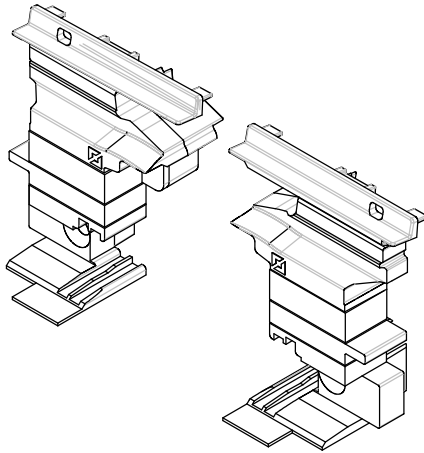

ACX.04.03HP
Coppia tappi
di riporto

APPLICAZIONE ACCESSORI

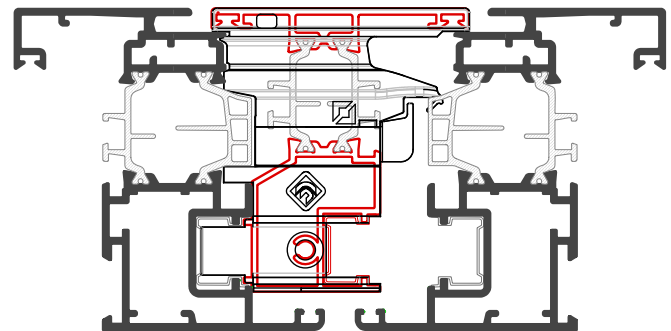
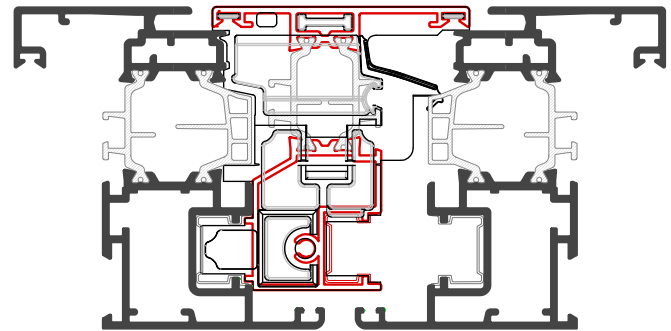
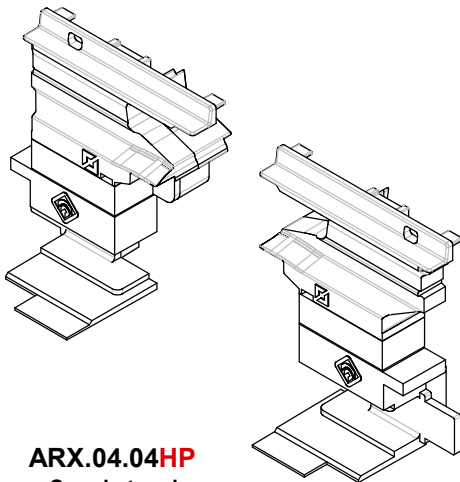

ARX.04.04HP
Coppia tappi
di riporto



APPLICAZIONE ACCESSORI

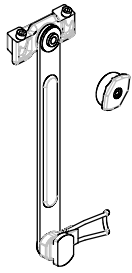

ACX.02.08
Braccio limitatore
altezza anta da 260mm a 800mm

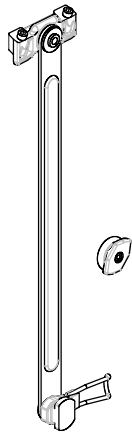

ACX.02.07
Braccio limitatore
altezza anta da 600mm a 1600mm

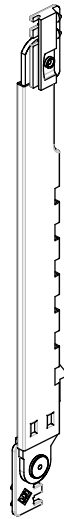

ACX.02.09
Braccio telescopico a scatto

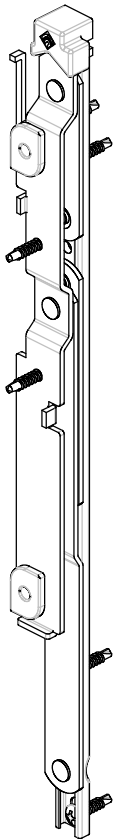
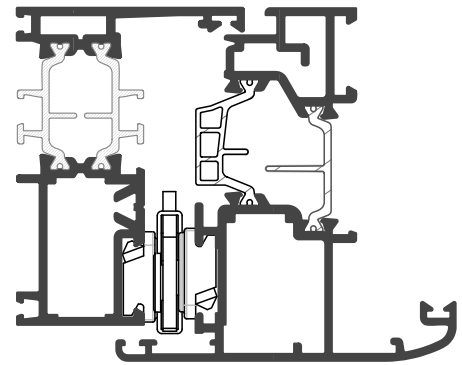
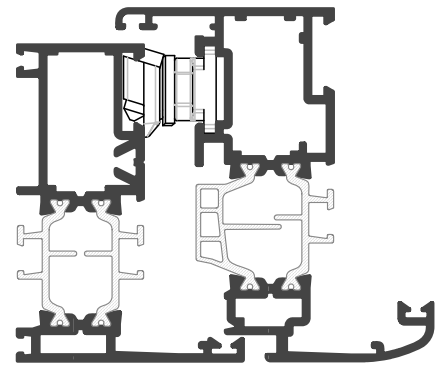

ACX.02.10
Cerniera a compasso

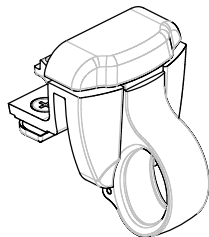
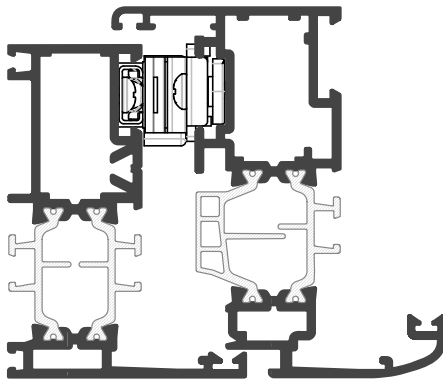

ACX.03.01
Cricchetto ad aggancio con piastrene
per telai sormonto

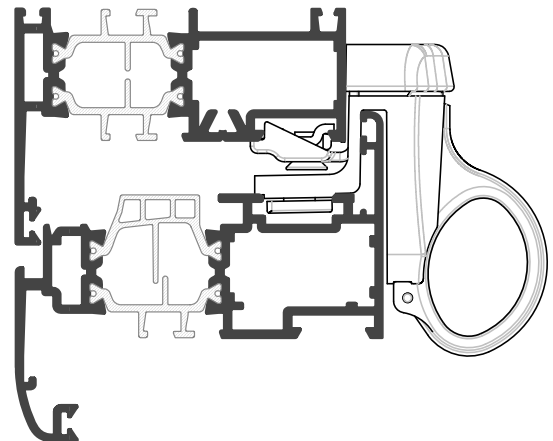



APPLICAZIONE ACCESSORI

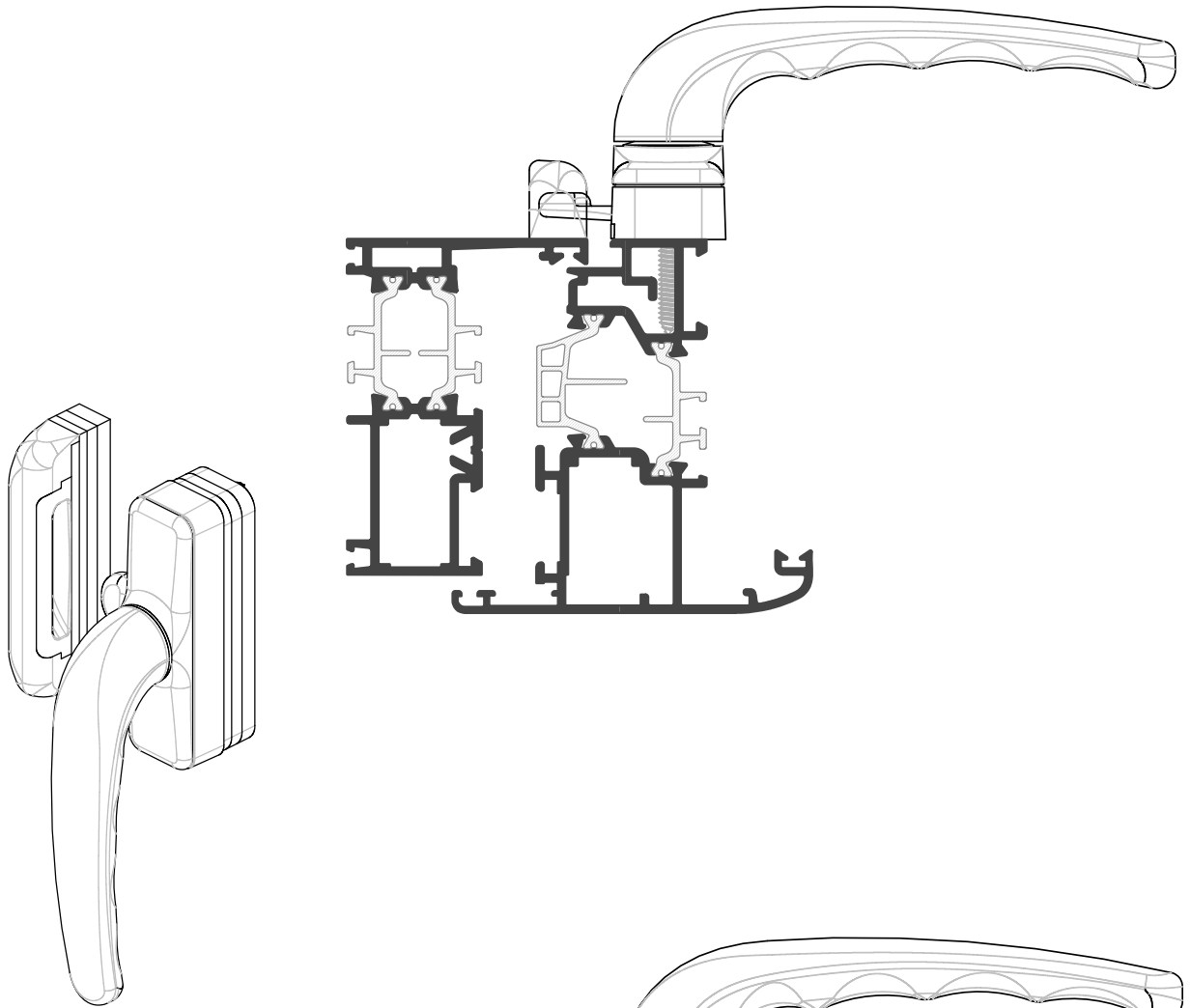

ARX.03.02
Maniglia a tavellino

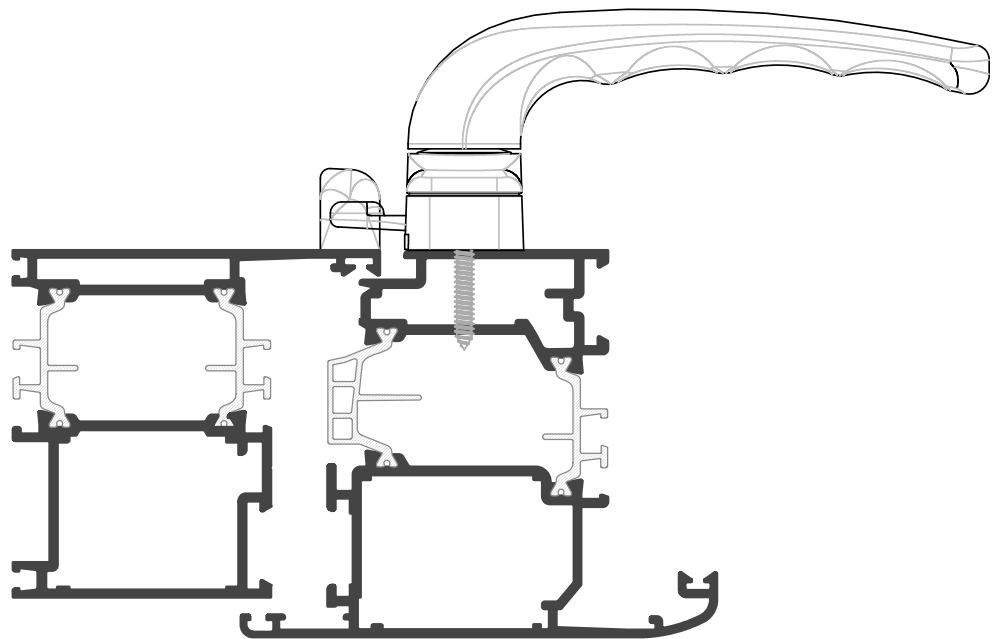



APPLICAZIONE ACCESSORI



ACX.03.73
"COMFORT MINI"
Martellina ridotta
Sporgenza quadro mm.70



ACX.03.74
"COMFORT MINI"
Martellina ridotta con
cilindro
Sporgenza quadro mm.70

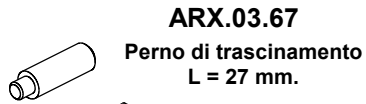

ARX.03.67
Perno di trascinamento
L = 27 mm.

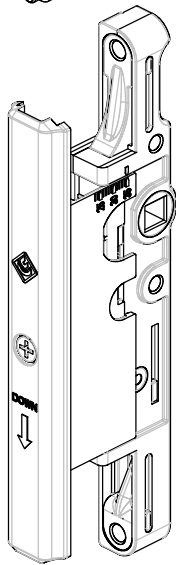

ACX.03.72
Movimentazione Bidirezionale
Interasse 23 - 35 mm.

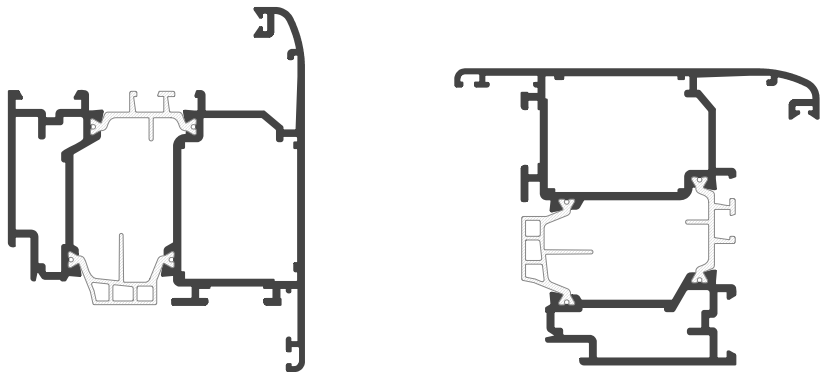
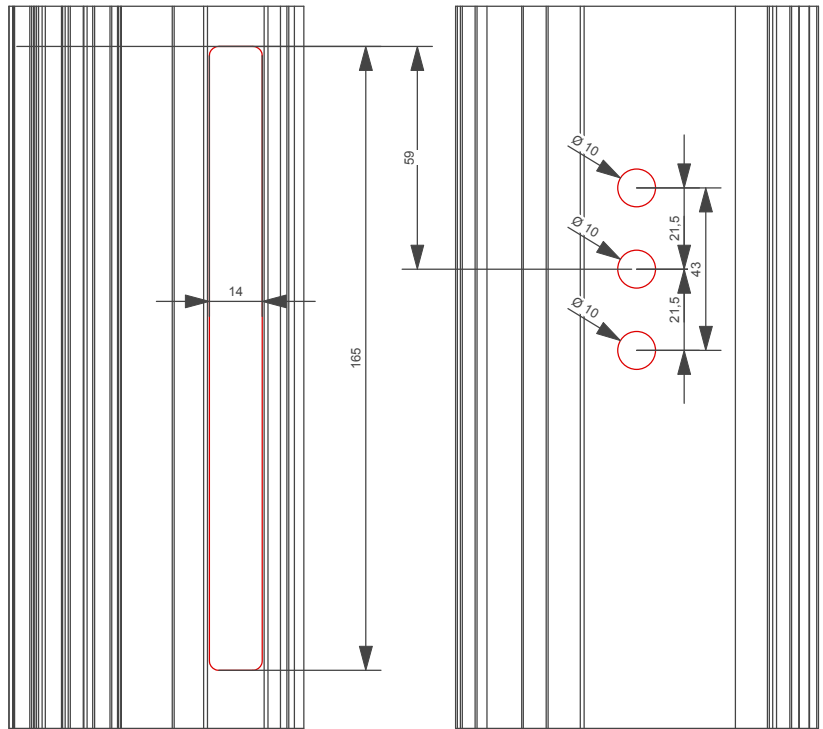
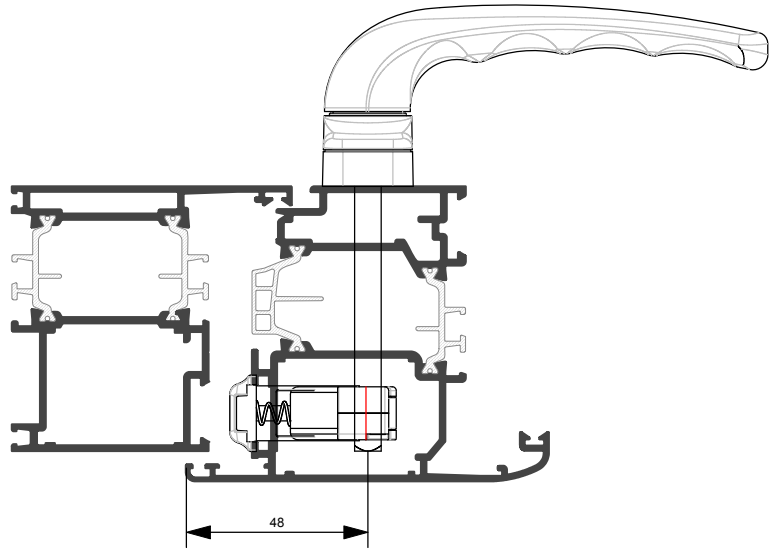



APPLICAZIONE ACCESSORI

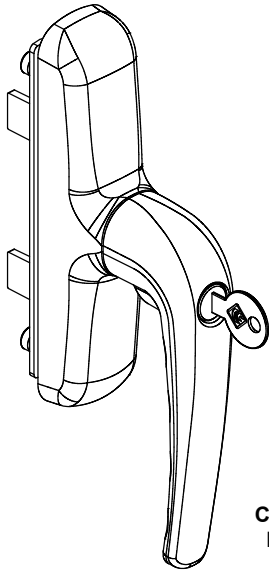

ARX.03.07
Cremonese con chiave
Interasse 84 - 92 - 104

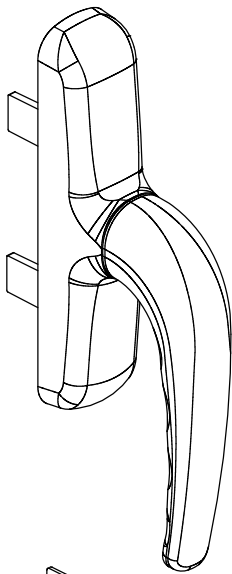
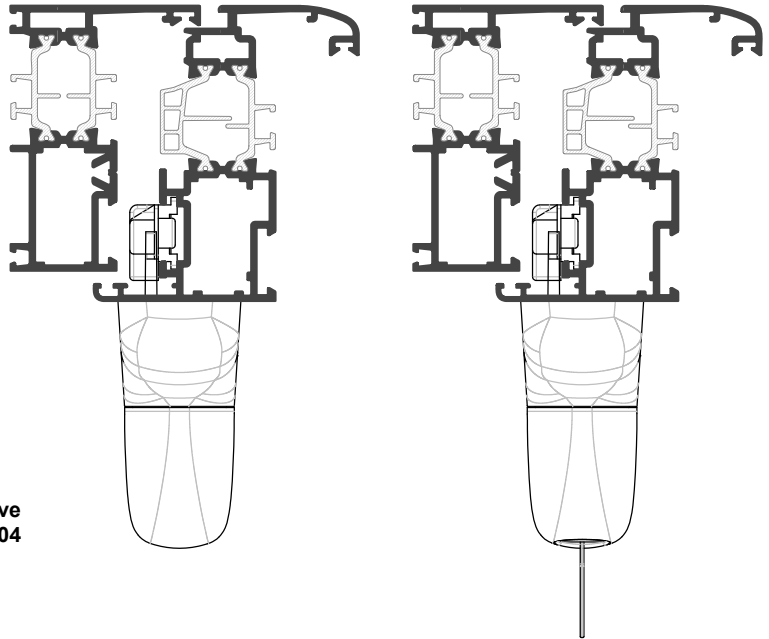

ARX.03.06
Cremonese
Interasse 84 - 92 - 104

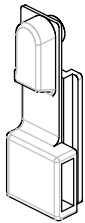
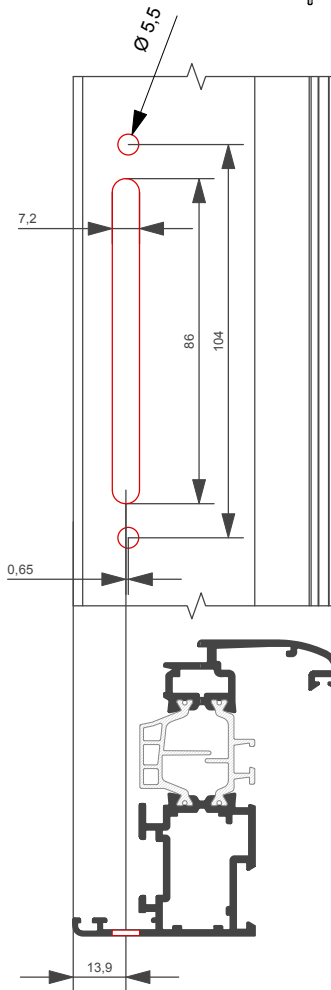

ACX.03.17
Innesti cremonese



APPLICAZIONE ACCESSORI

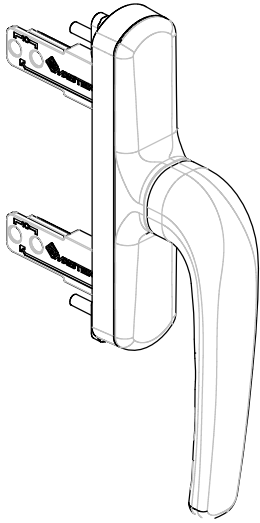

ARX.03.47

Cremonese apertura
esterna - int. 28/65mm

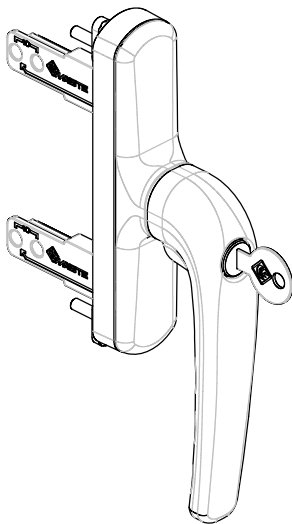
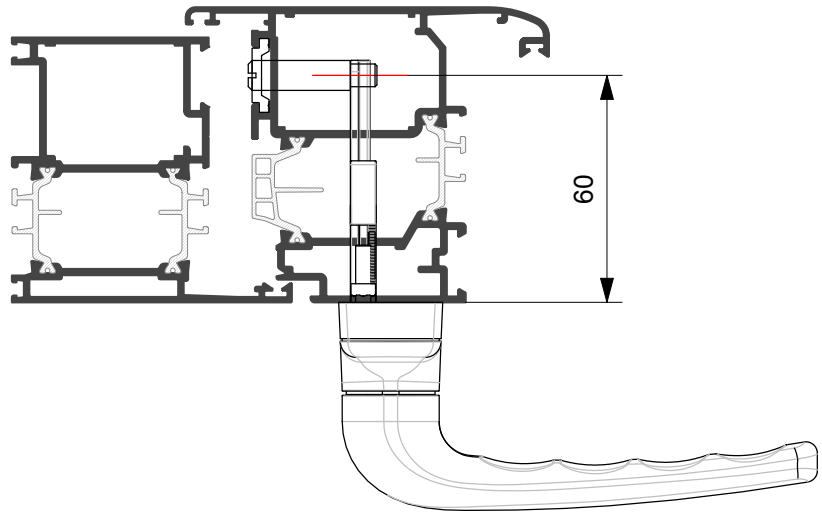

ARX.03.48

Cremonese apertura esterna
con chiave - int. 38/65mm

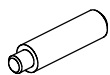
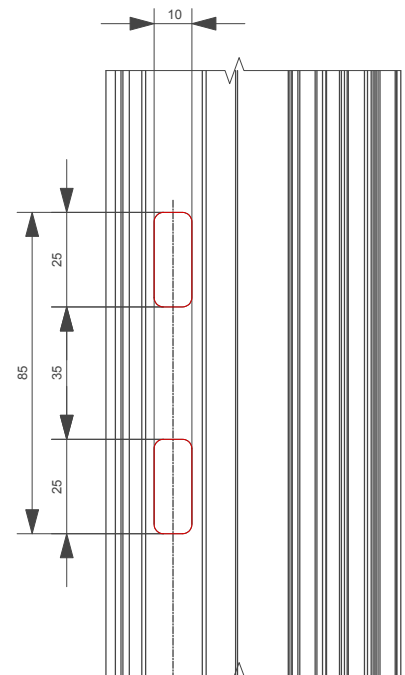
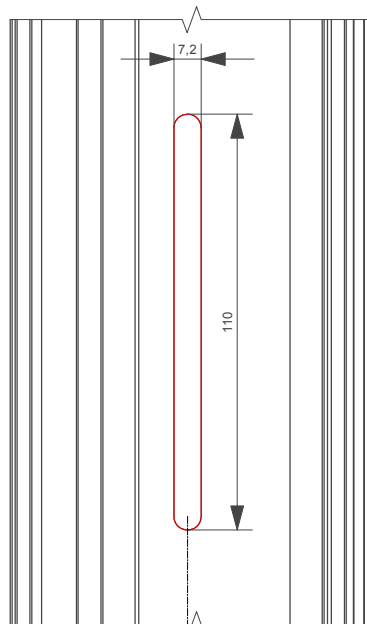

ACX.03.67

Perno di trascimento
L=27mm

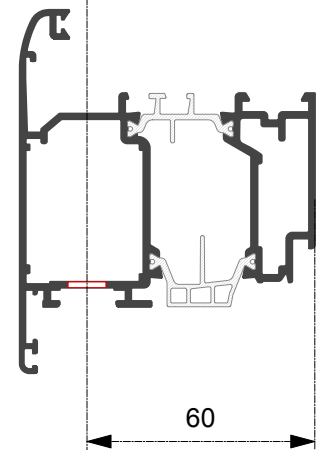
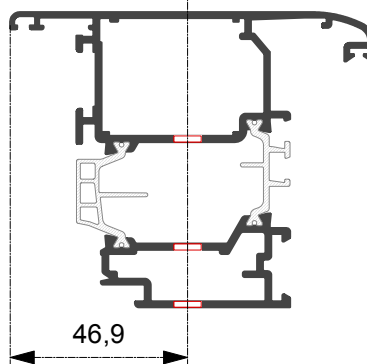



APPLICAZIONE ACCESSORI

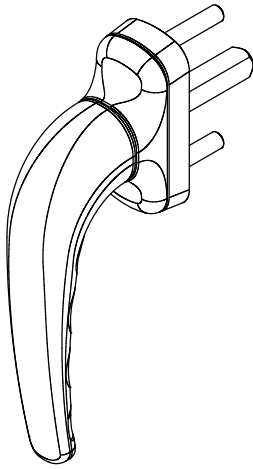

ARX.03.04
Martellina
Sporgenza quadro mm.24

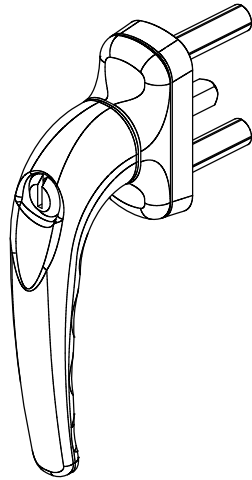

ARX.03.05
Martellina con chiave
Sporgenza quadro mm.24

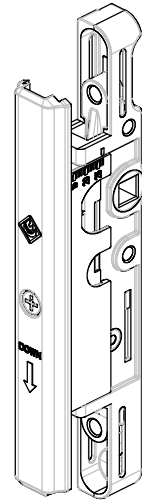

ARX.03.09
Movimentazione bidirezionale
regolabile 15 - 27 mm.



ACX.03.66
Perno 11 mm.

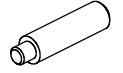
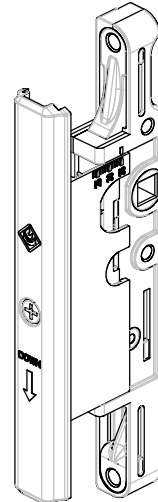

ACX.03.67
Perno 27 mm.

ACX.03.72
Movimentazione bidirezionale
regolabile 23 - 35 mm.

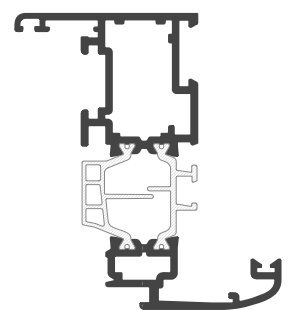
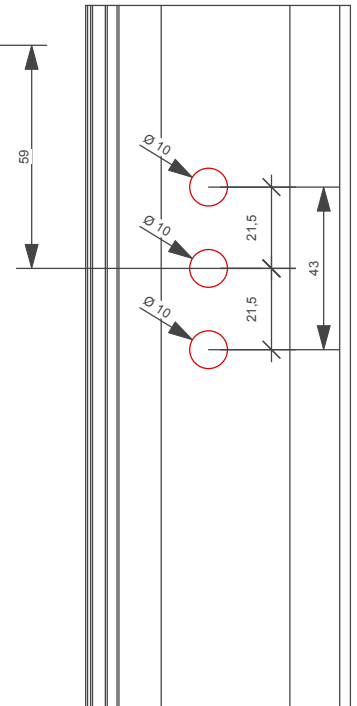
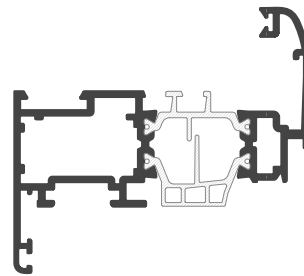
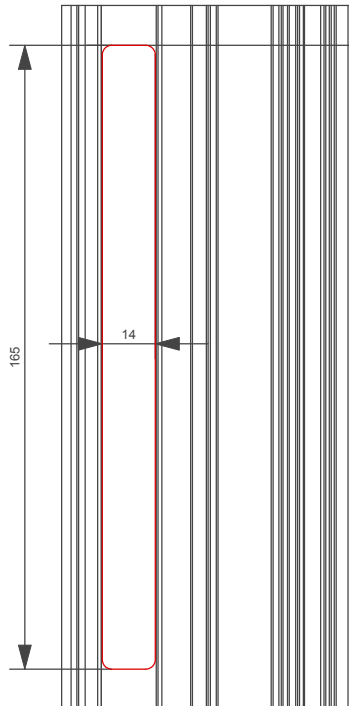
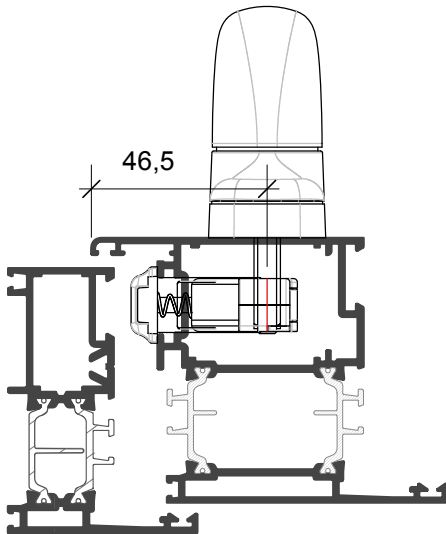
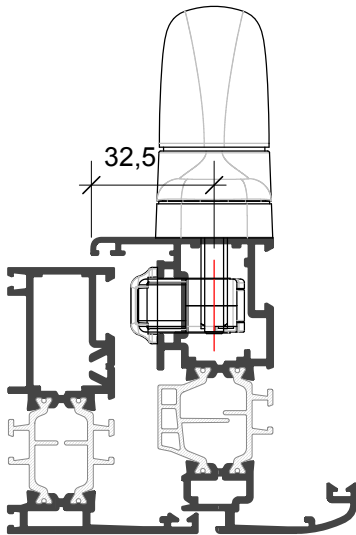



APPLICAZIONE ACCESSORI

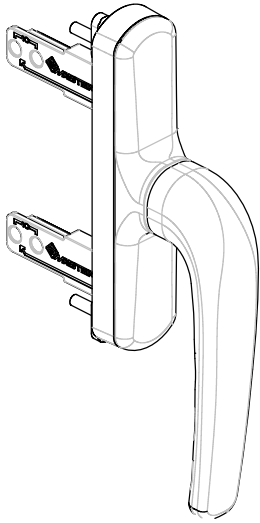

ARX.03.47

Cremonese apertura
esterna - int. 28/65mm

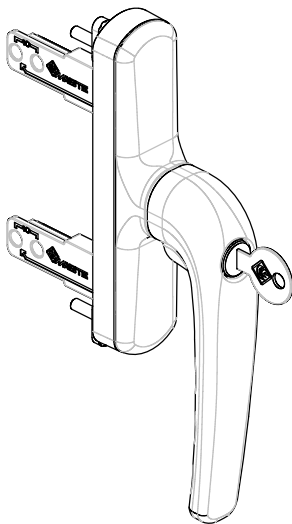
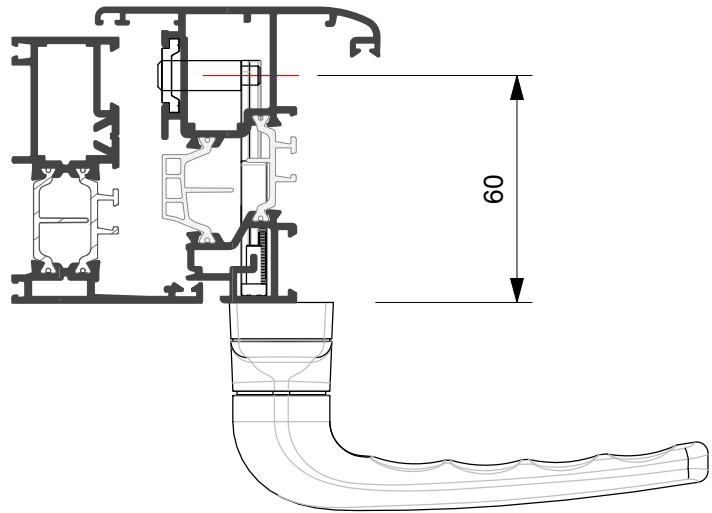

ARX.03.48

Cremonese apertura esterna
con chiave - int. 38/65mm

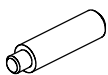
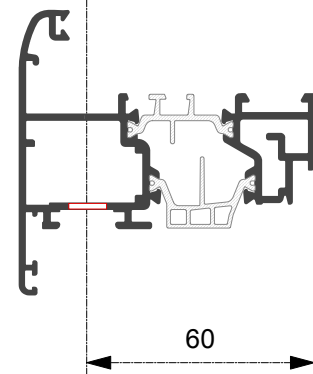
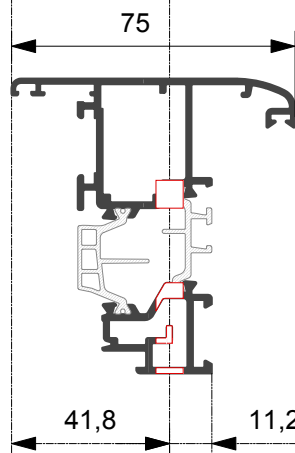
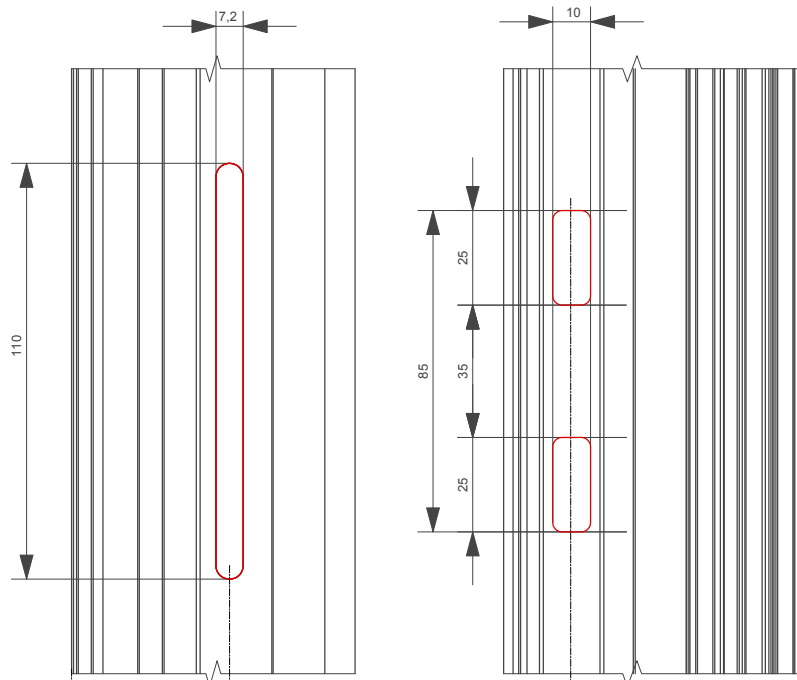

ARX.03.45

Perno di trascinamento
L=22mm



APPLICAZIONE ACCESSORI

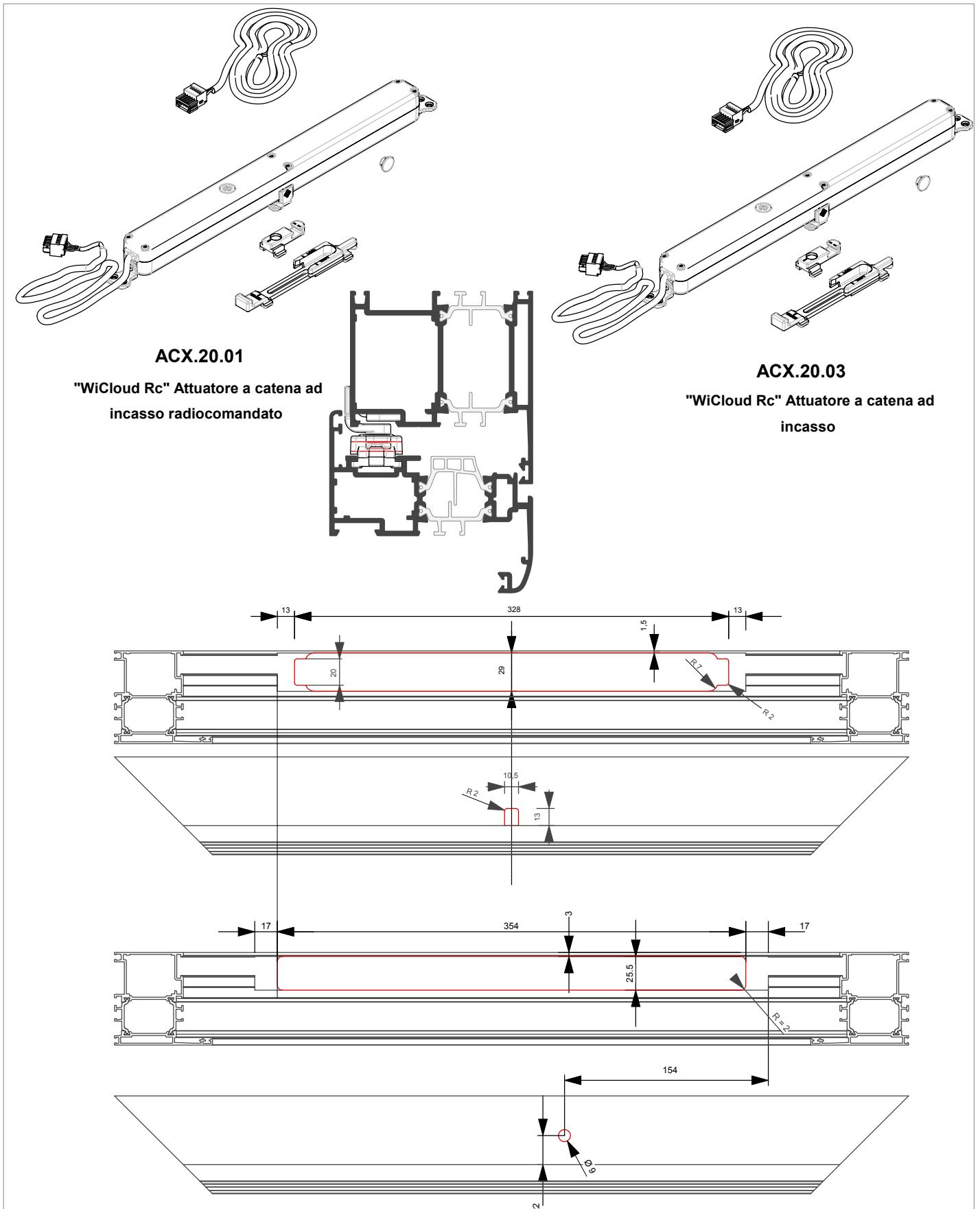

NB. Maggiori idettagli di montaggio nella confezione



APPLICAZIONE ACCESSORI

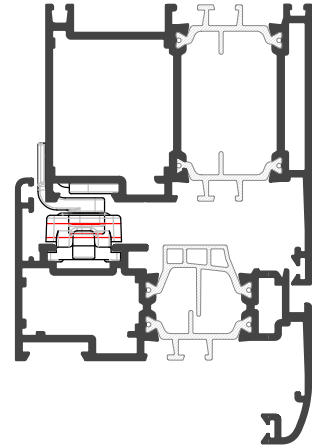
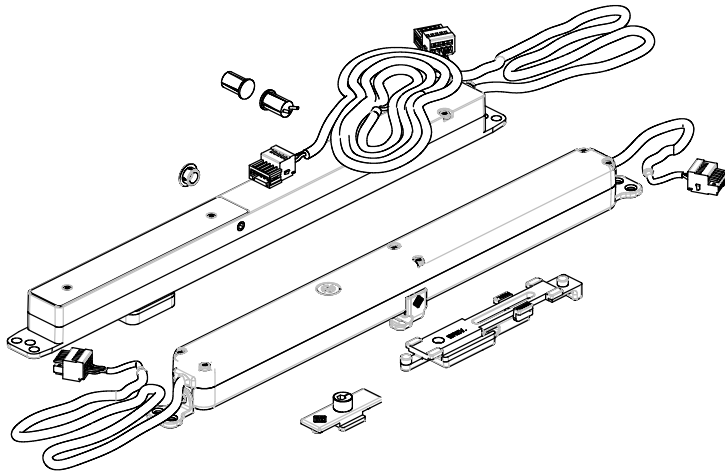

ACX.20.04
"WiCloud Rc - Lock"

Attuatore a catena radiocomandato + serratura elettromeccanica

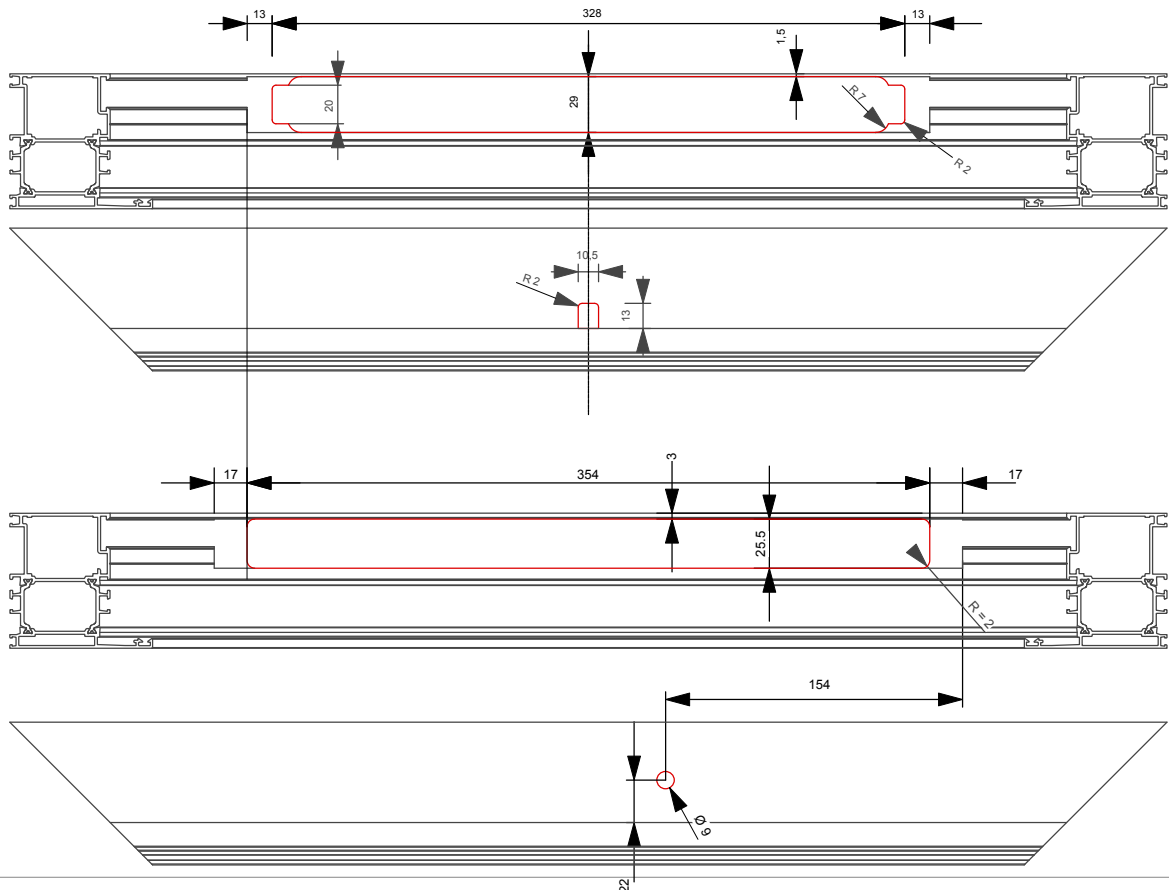

NB. Maggiori idettagli di montaggio nella confezione

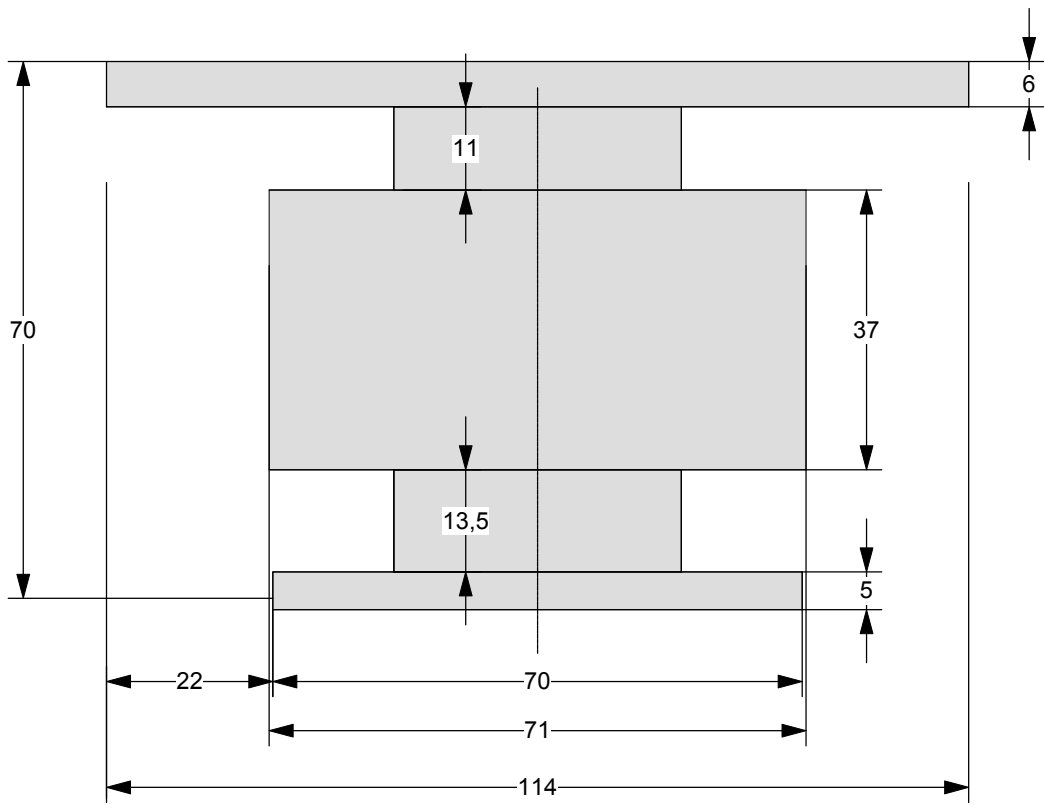
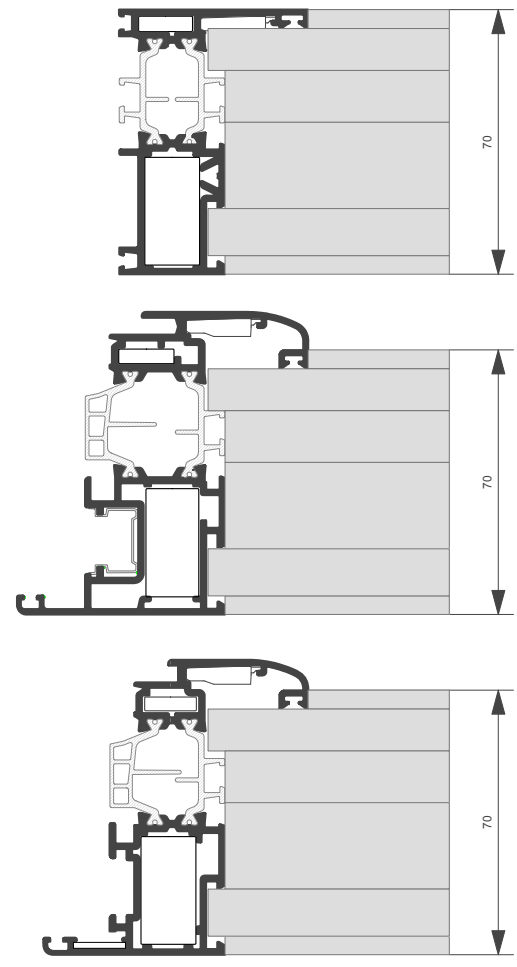



APPLICAZIONE ACCESSORI

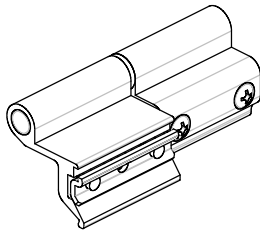

ACX.02.01

Cerniera a montaggio rapido a 2 ali

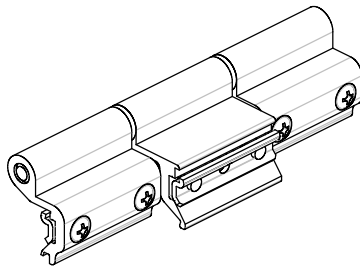

ACX.02.03

Cerniera a montaggio rapido a 3 ali

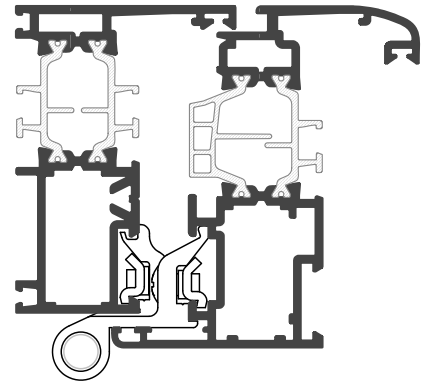

APPLICAZIONE ACCESSORI

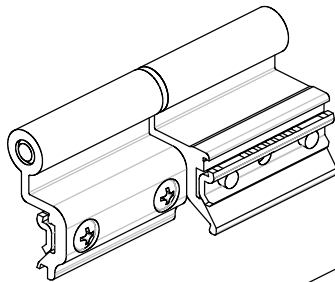

ACX.02.02

Cerniera a montaggio rapido a 2 ali

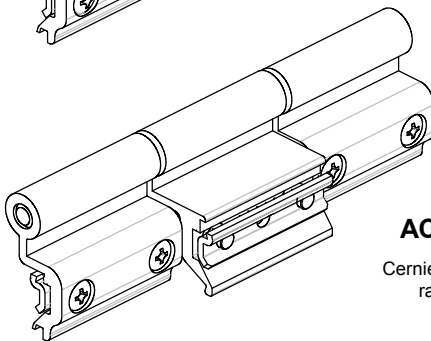

ACX.02.04

Cerniera a montaggio rapido a 3 ali

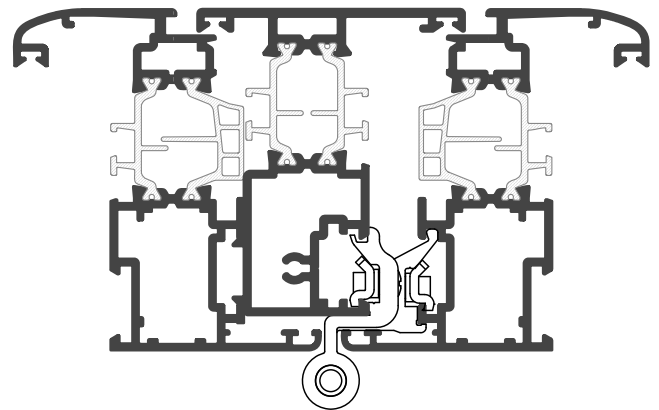

APPLICAZIONE ACCESSORI

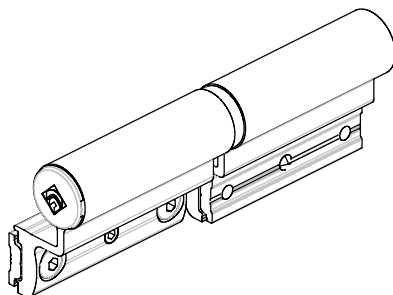

ACX.02.11

Cerniera porte a 2 ali

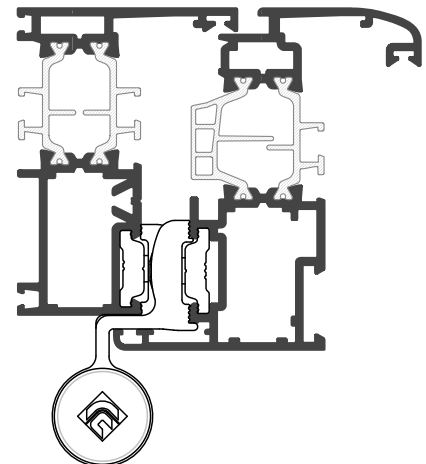



APPLICAZIONE ACCESSORI

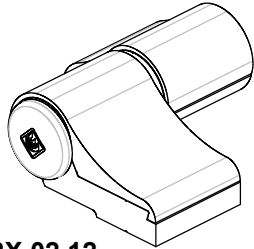
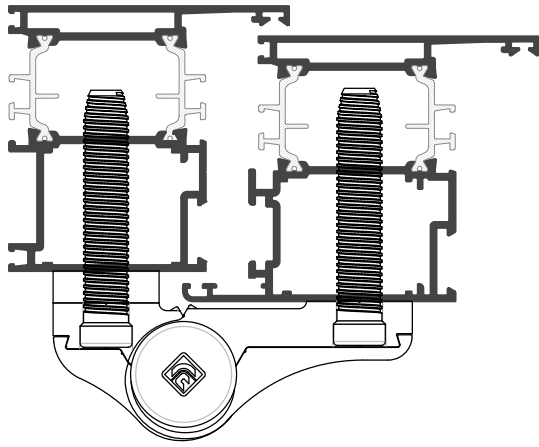

ARX.02.12

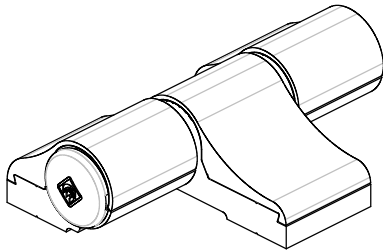

ARX.02.13

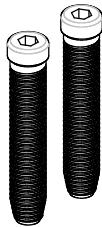

ARX.02.23

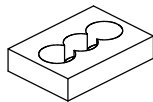

ARX.02.25

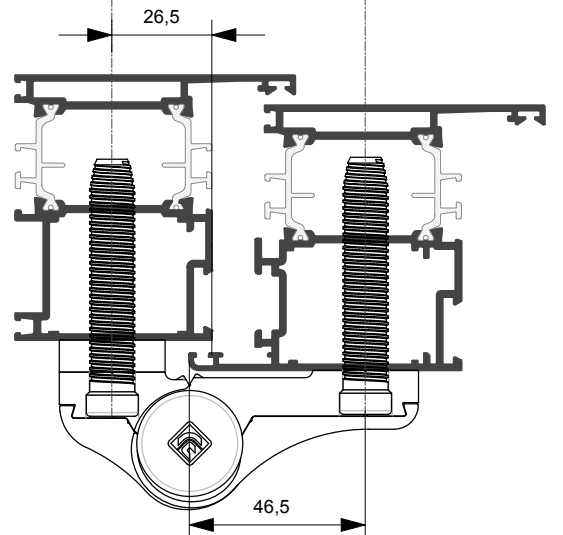
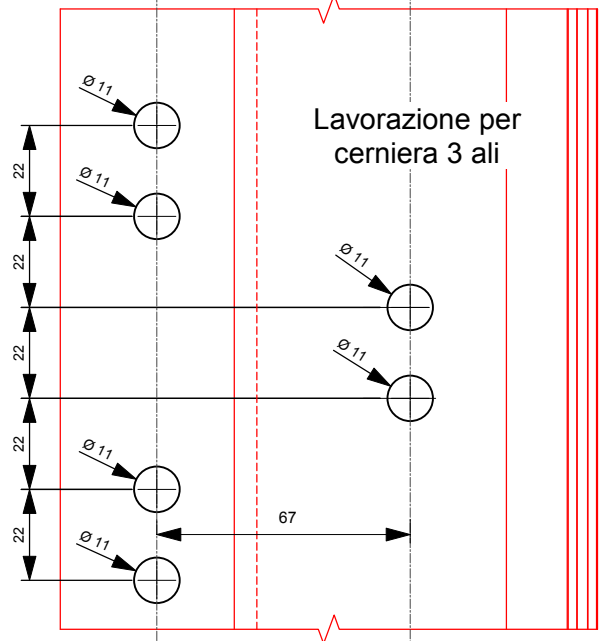
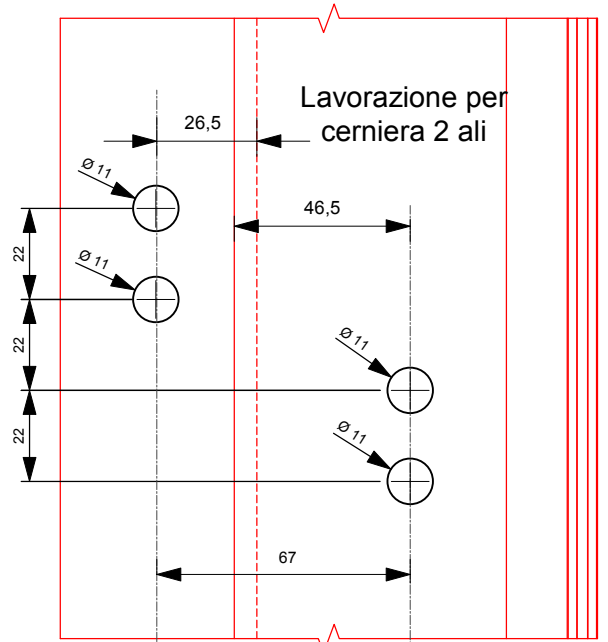



APPLICAZIONE ACCESSORI

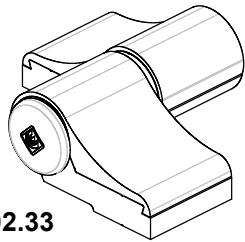
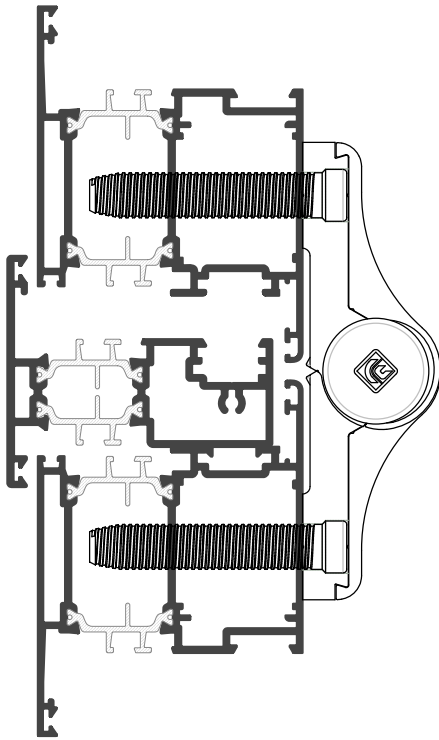

ARX.02.33

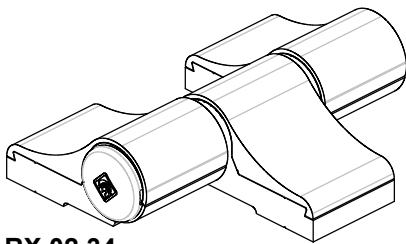

ARX.02.34

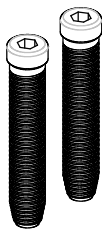

ARX.02.23

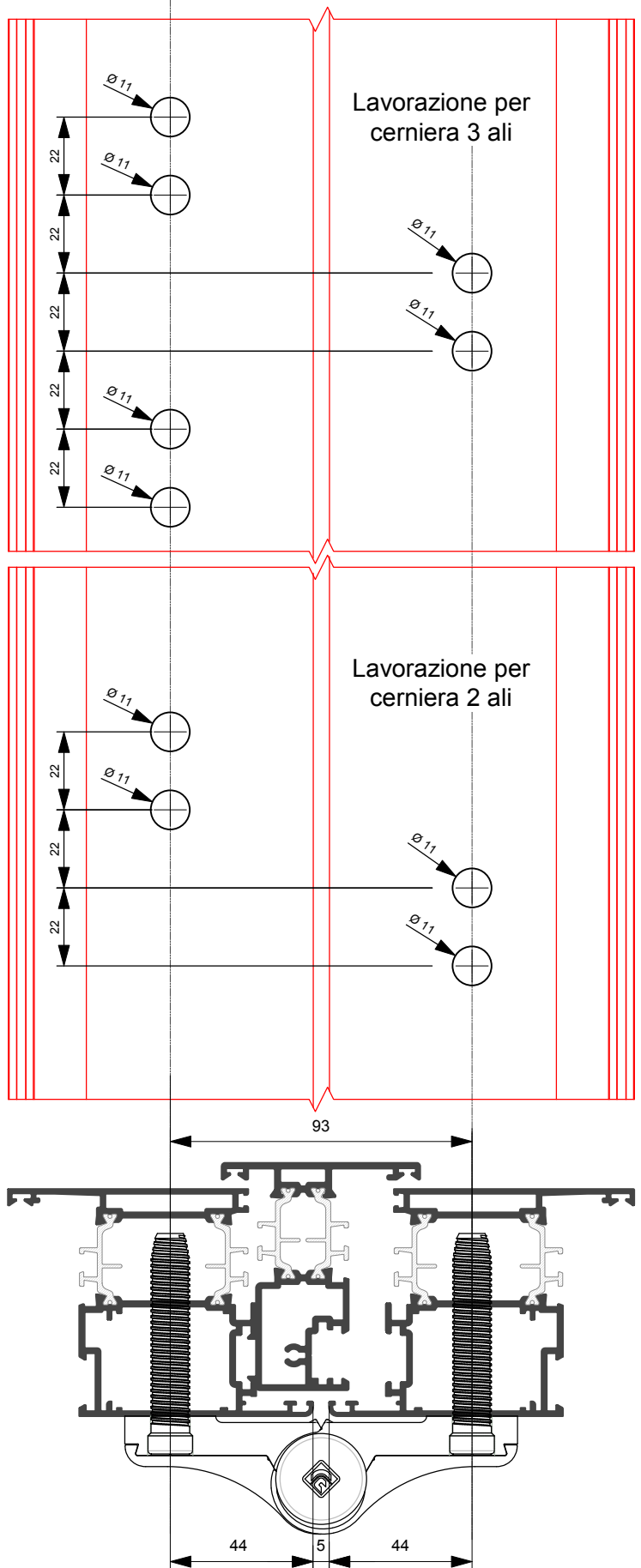



APPLICAZIONE ACCESSORI

ACX.08.39

WEEN HIDE 180- Sx/Dx Cerniera inferiore

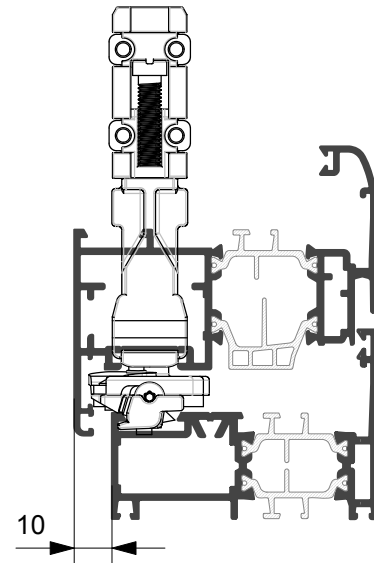
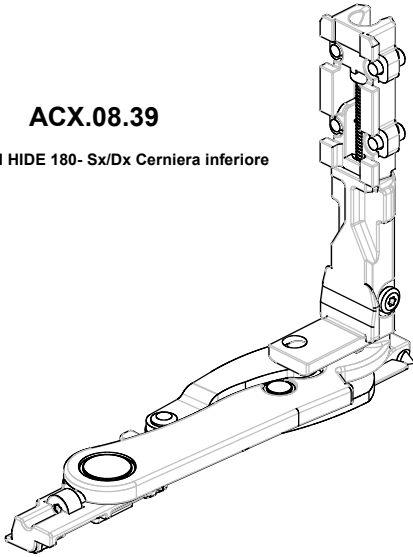

NB

Solo per anta **CX70.260HP** e **CX70.261HP**

APPLICAZIONE ACCESSORI

ACX.08.36

WEEN HIDE 180- Dx Braccio a scomparsa per apertura a battente

ACX.08.37

WEEN HIDE 180- Sx Braccio a scomparsa per apertura a battente

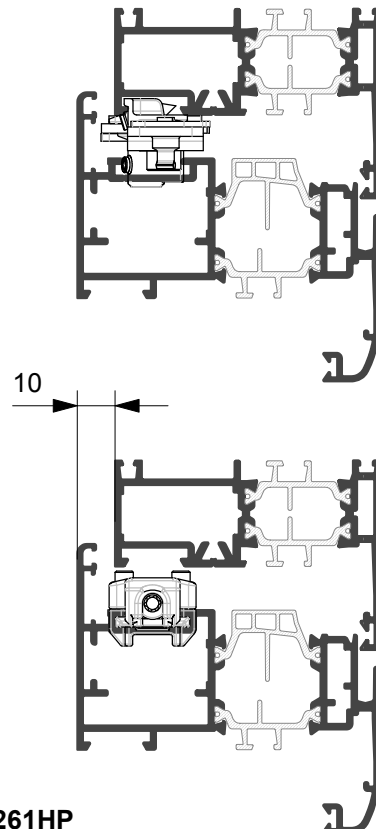
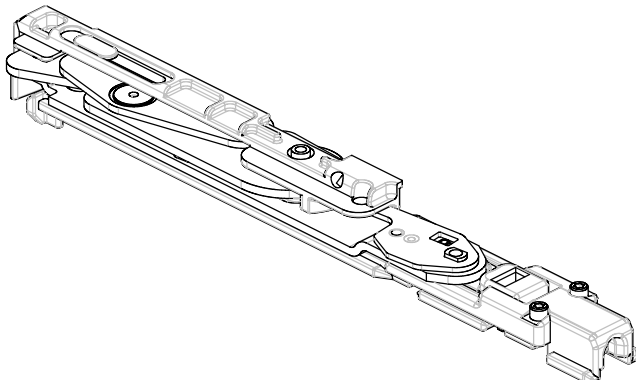

NB

Solo per anta **CX70.260HP** e **CX70.261HP**



APPLICAZIONE ACCESSORI

RIBALTA

ACX.08.40

Ween hide 180

kit base anta ribalta con anti falsa manovra sulla
cremonese ante CX70.260HP e CX70.261HP

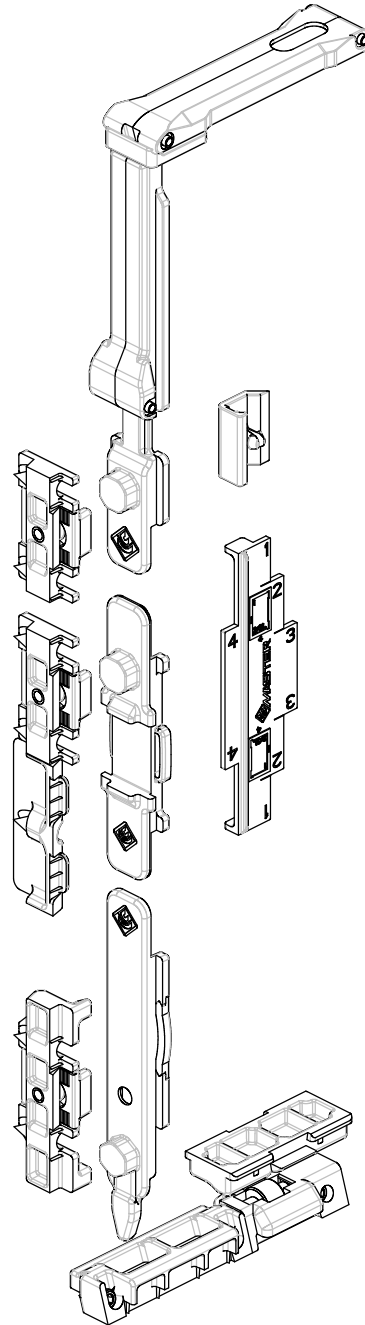
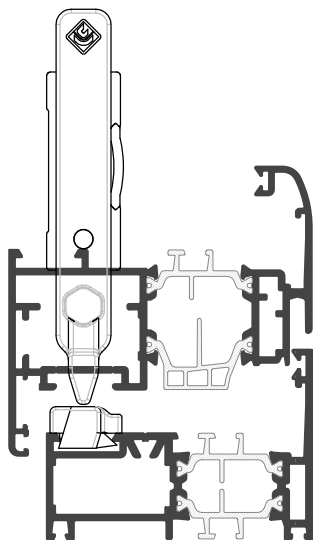
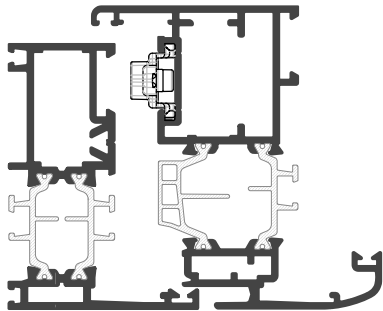
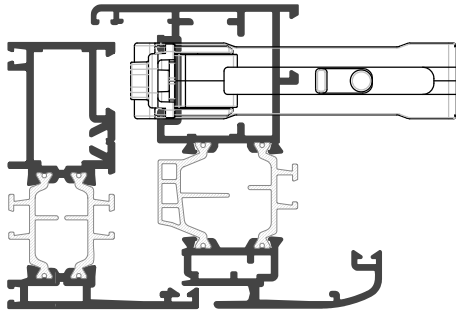

NB

Solo per anta **CX70.260HP** e **CX70.261HP**



APPLICAZIONE ACCESSORI

RIBALTA

ACX.08.41

Ween hide 180

kit base anta ribalta con anti falsa manovra sulla cremonese
ante CX70.260HP e CX70.261H

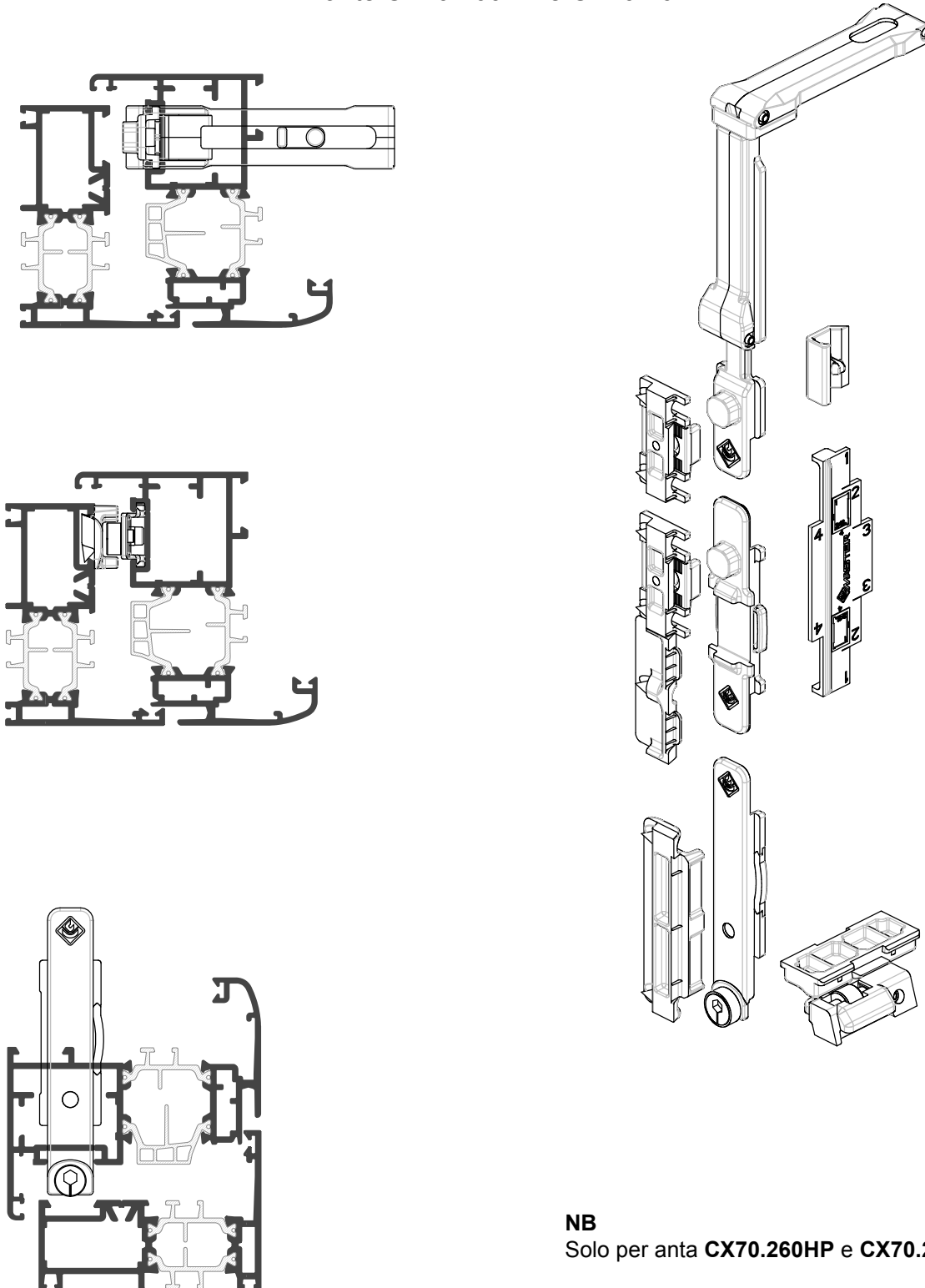

NB

Solo per anta **CX70.260HP** e **CX70.261HP**



APPLICAZIONE ACCESSORI

RIBALTA

ACX.08.01

Kit base anta ribalta
Portata massima 160Kg

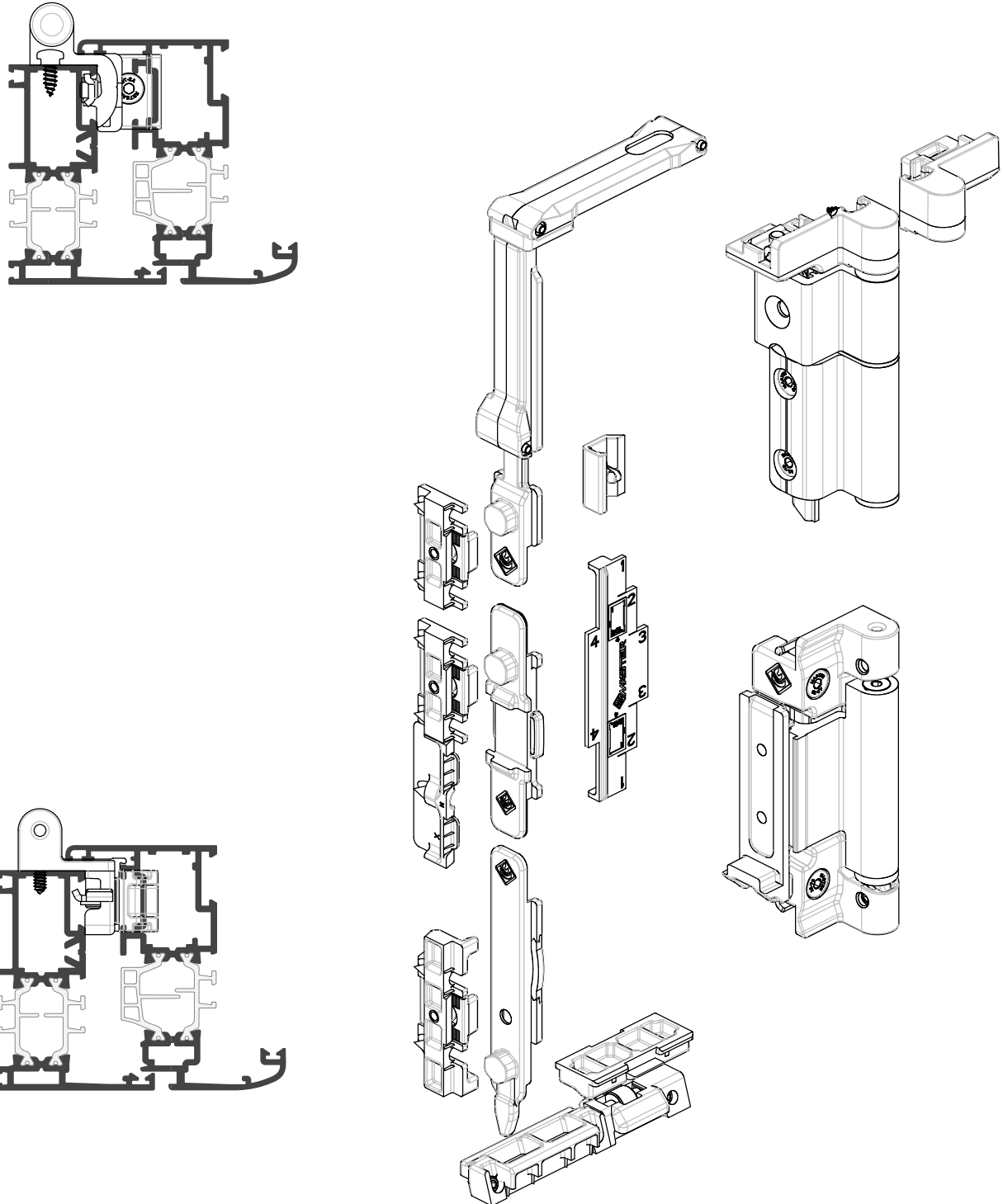



APPLICAZIONE ACCESSORI

RIBALTA

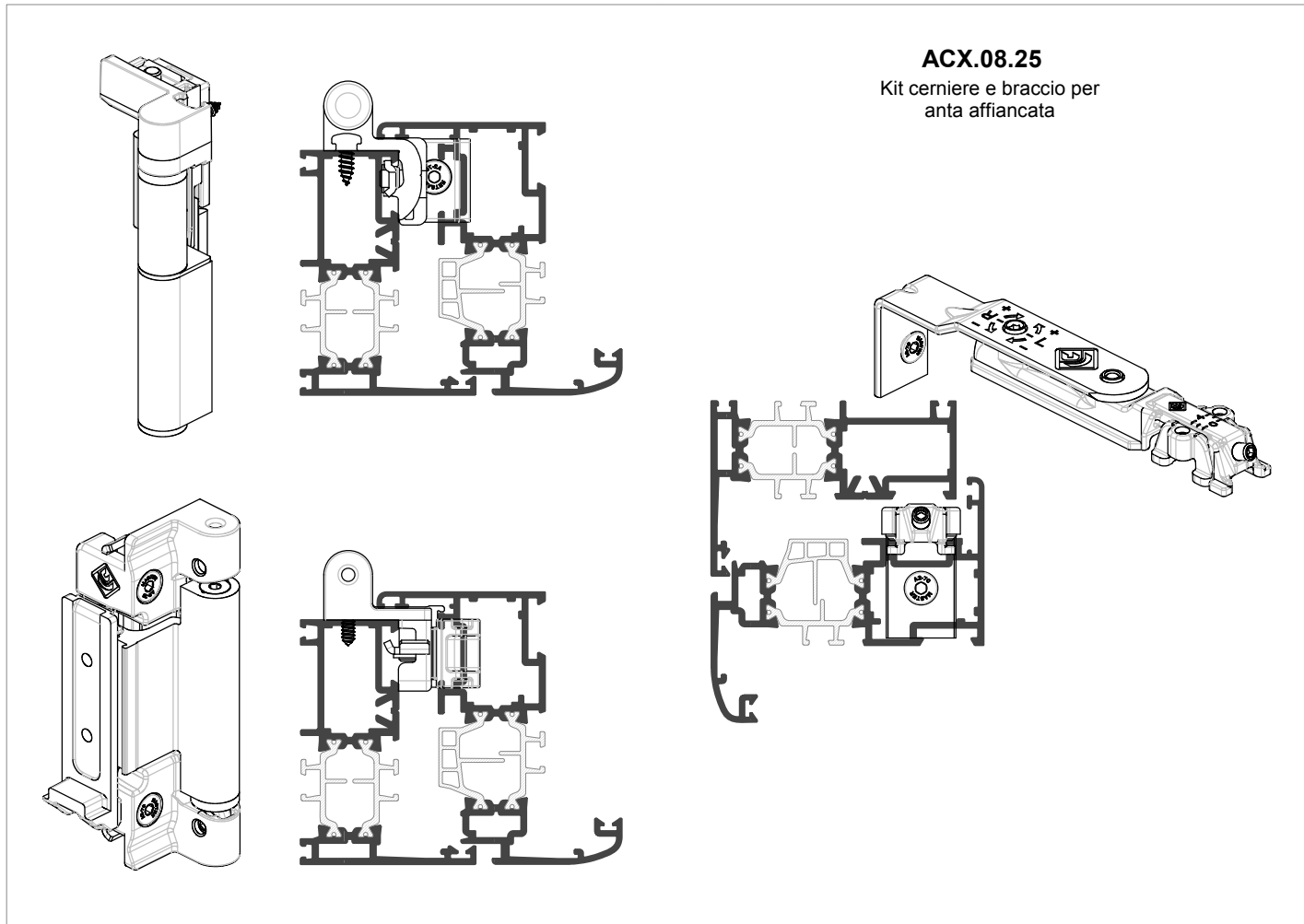

ACX.08.25

Kit cerniere e braccio per anta affiancata

APPLICAZIONE ACCESSORI

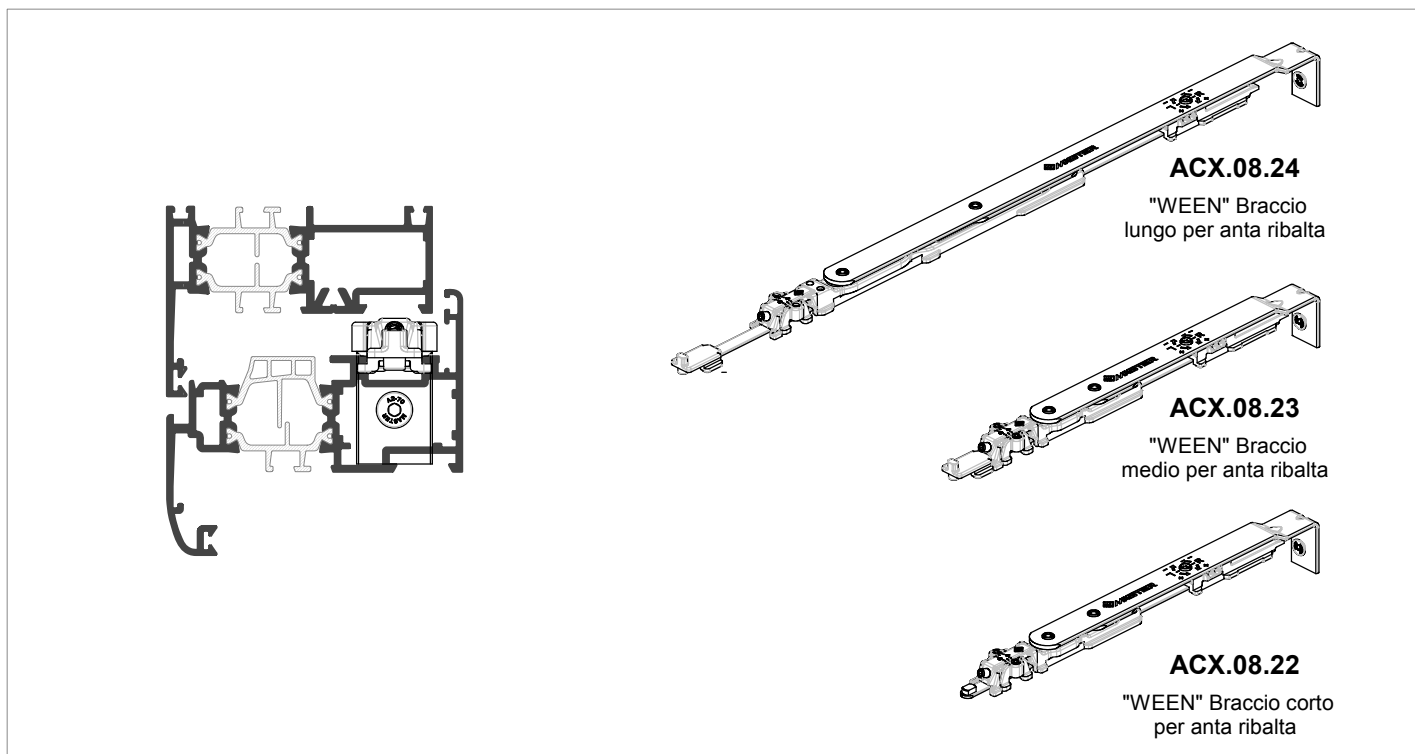

ACX.08.24

"WEEN" Braccio lungo per anta ribalta

ACX.08.23

"WEEN" Braccio medio per anta ribalta

ACX.08.22

"WEEN" Braccio corto per anta ribalta



APPLICAZIONE ACCESSORI

RIBALTA

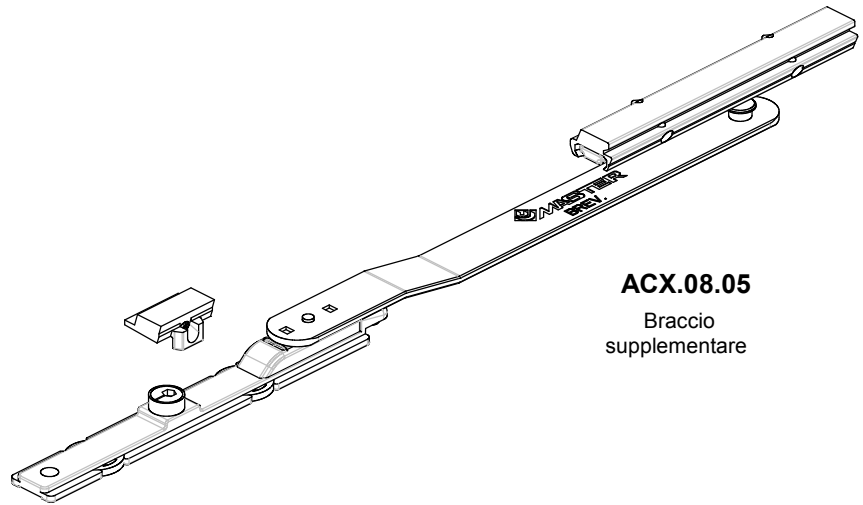
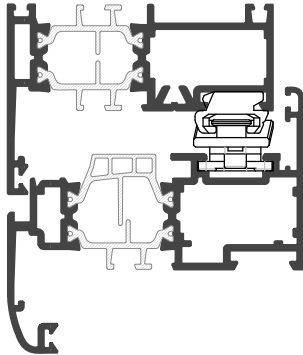

ACX.08.05
Braccio
supplementare

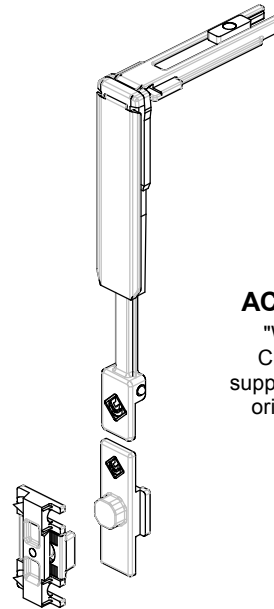
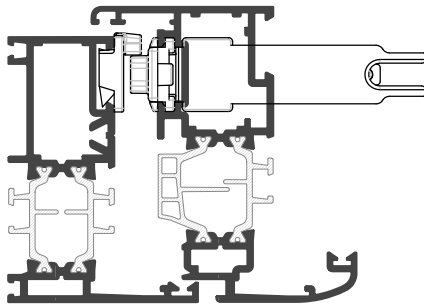

ACX.08.06
"WEEN"
Chiusura
supplementare
orizz./vert.

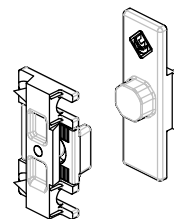
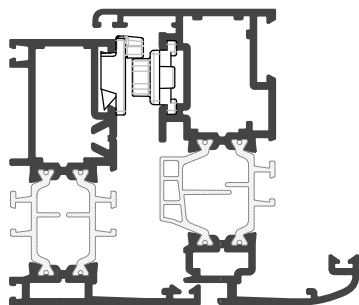

ACX.08.16
"WEEN"
Punto chiusura
supplementare



APPLICAZIONE ACCESSORI

RIBALTA

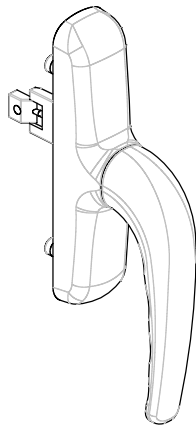

ARX.03.08
Cremonese per anta ribalta

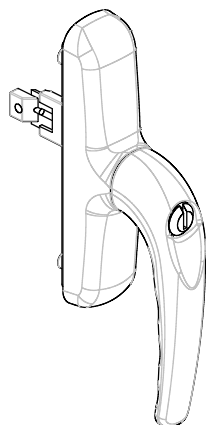
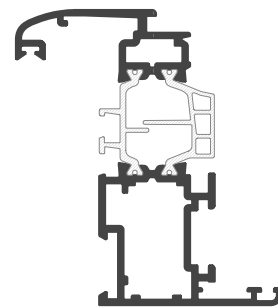
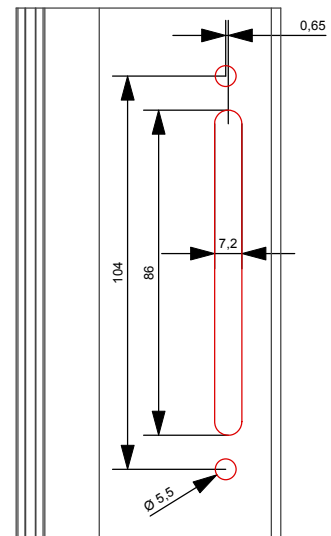
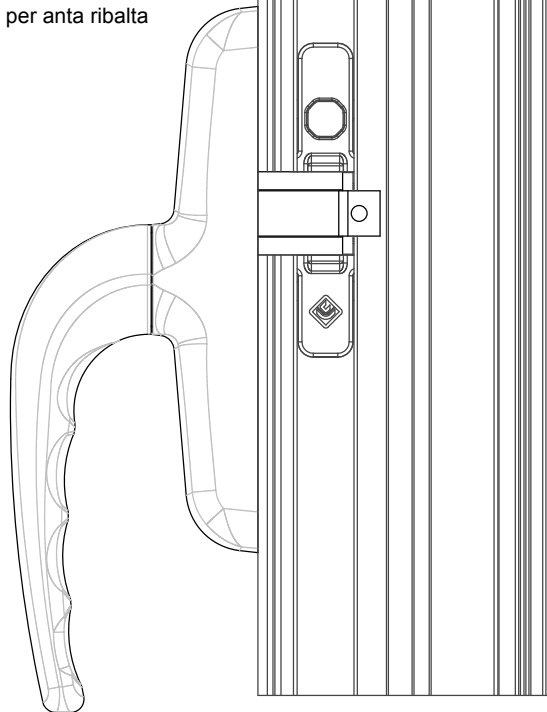

ARX.03.46
Cremonese con chiave per anta ribalta

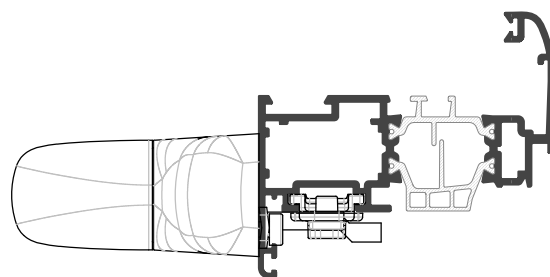



APPLICAZIONE ACCESSORI

SLIM

ACX.03.70

catenaccio a comando diretto SIRIO

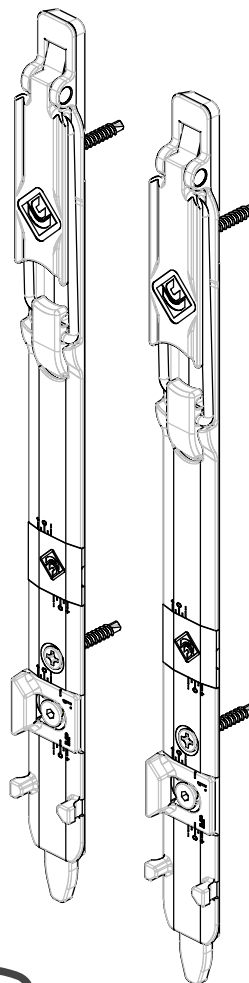
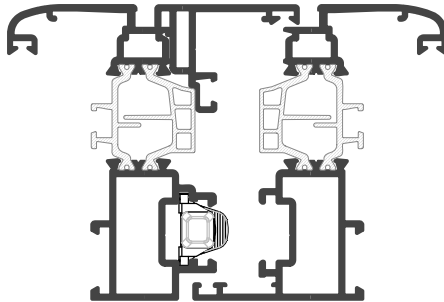
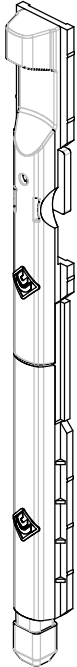

ACX.03.71

Catenaccio a leva "Mini tex"

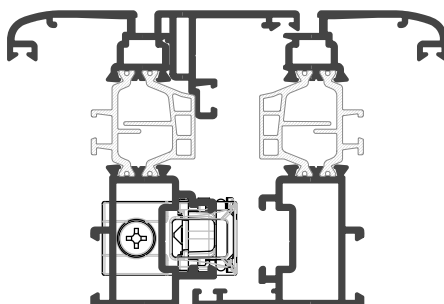
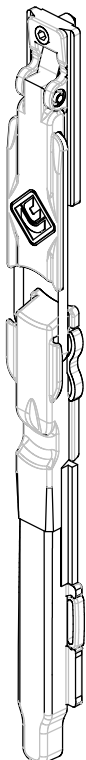

ACX.08.44

Kit catenacci a leva per anta affiancata

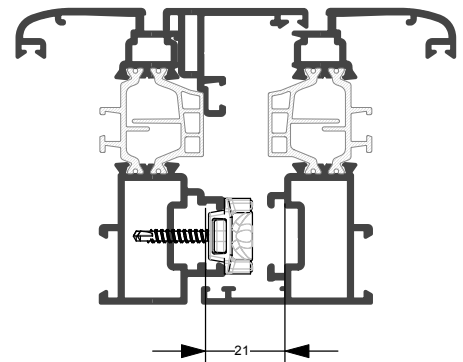





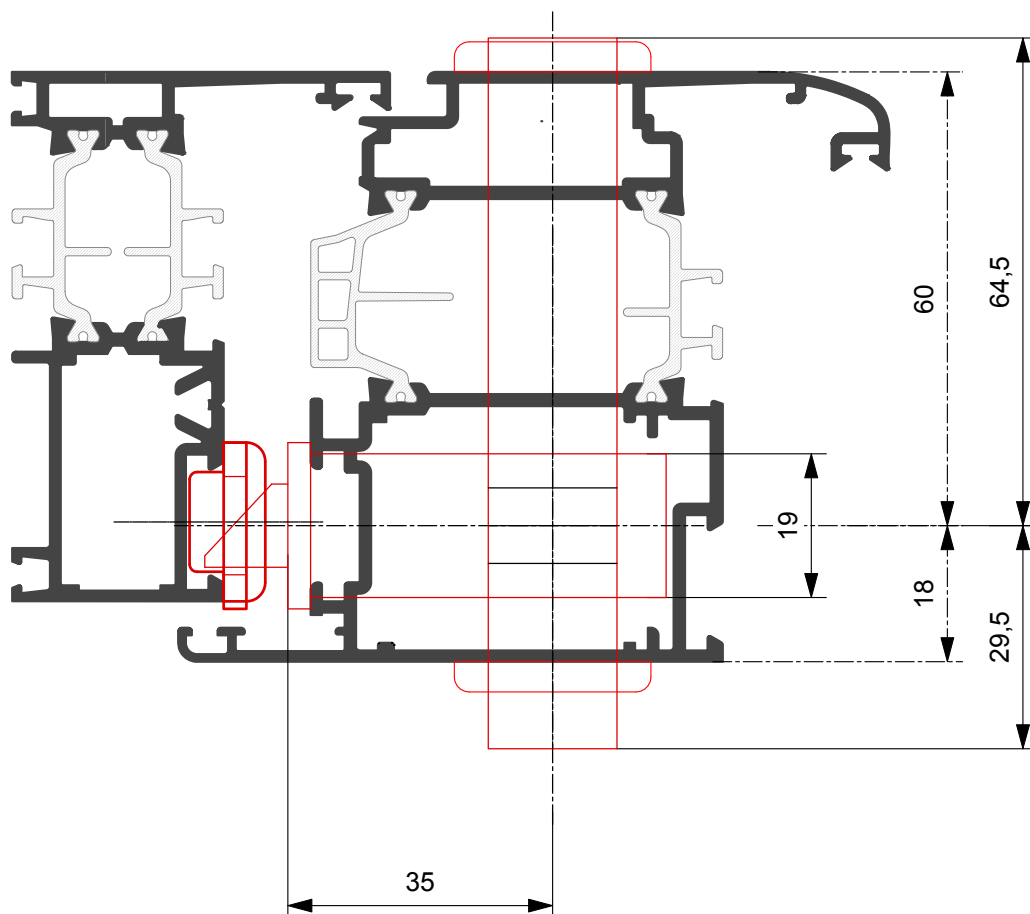

SERRATURE DI SICUREZZA DA MONTANTE 1 PUNTO DI CHIUSURA

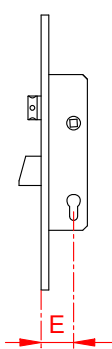

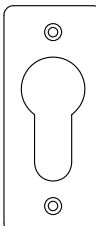
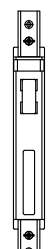
Riferimenti CISA





	Serratura E= 35 mm		Contropiastra		Cilindro		Borchia
	Tipologia	Art.	Metallo	Registrabile	 Tradizionale	 Sicurezza	 in dotazione
Catenaccio e scrocco	46215		06463 - 22- 0 per serrature rullo utilizzare inserto 06141.71.0		 Tradizionale	 Sicurezza	
Catenaccio e rullo	46230				0E300. 41.0.12	0A3S1. 41.0.12	
Elettrica con maniglia	16215						

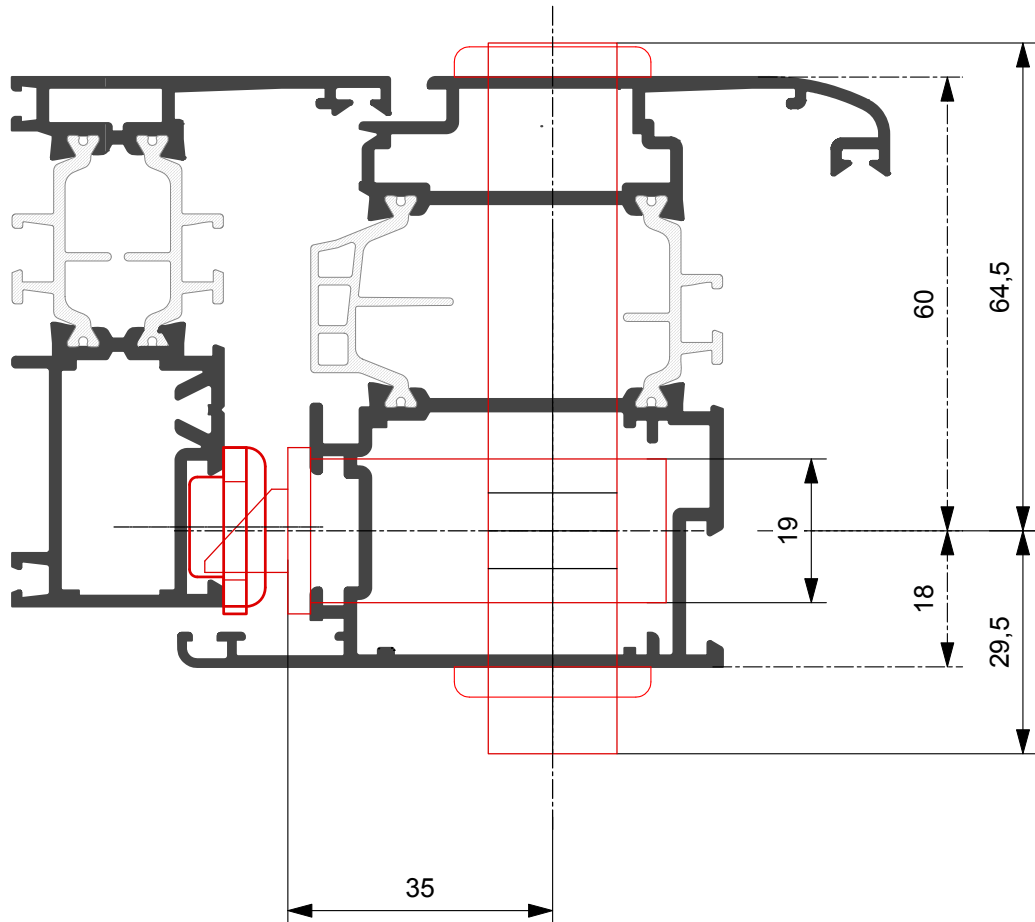

SERRATURE DI SICUREZZA DA MONTANTE 3 PUNTI DI CHIUSURA

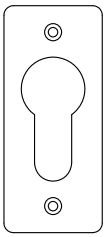
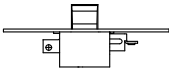

Riferimenti CISA





Serratura E= 35 mm	Contropiastra		Cilindro		Borchia		
	Tipologia	Art.	Metallo	Registrabile			
Catenaccio e scrocco	48225	 06463-32-0 per serrature rullo utilizzare inserto 06141.71.0	Serratura	Deviatori	 Tradizionale	 Sicurezza	 in dotazione
Catenaccio e rullo	48250			 06443-21/26-0			
Elettrica con maniglia	18225		 06465-42-0 (pz.2)		0E300. 41.0.12	0A3S1. 41.0.12	

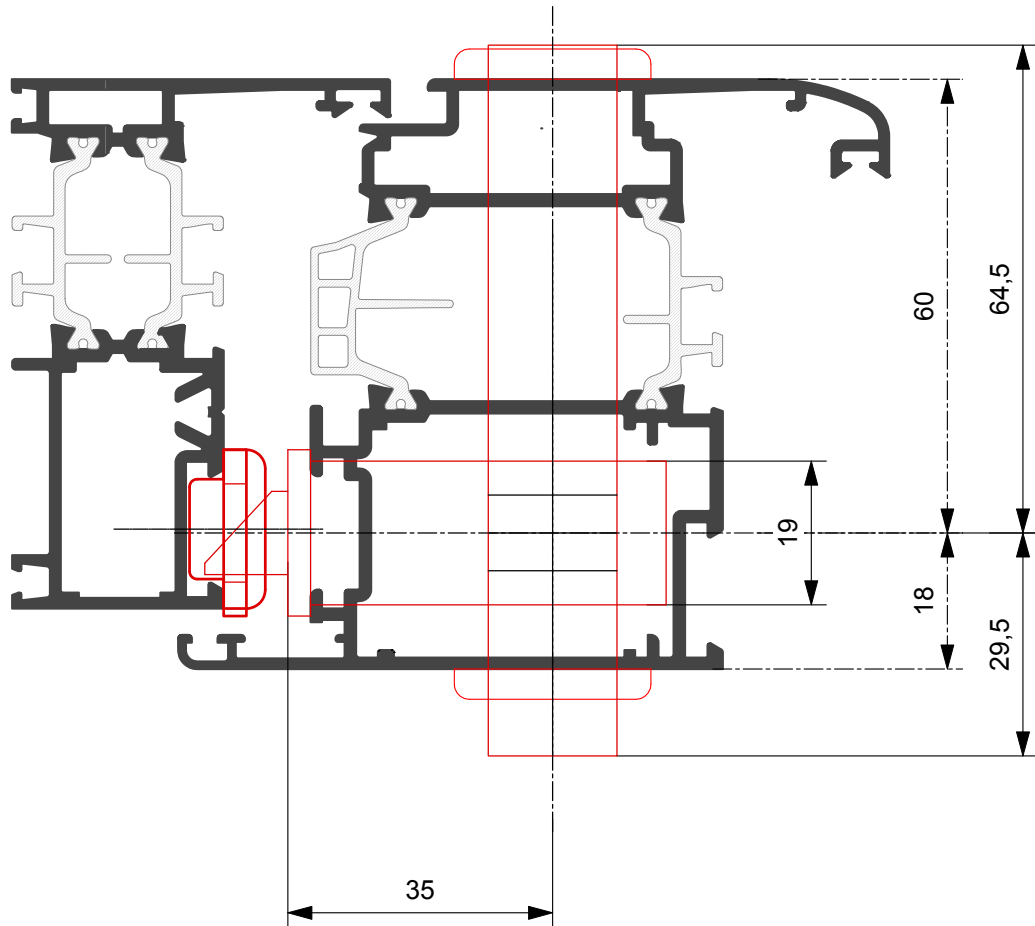

SERRATURE DI SICUREZZA DA MONTANTE 3 PUNTI DI CHIUSURA - FRONTALE INTERO

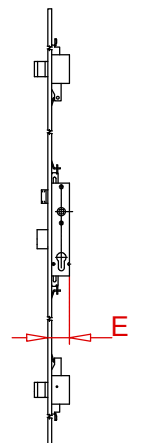
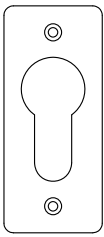

Riferimenti CISA

	Serratura E= 35 mm		Contropiastra		Cilindro		Borchia
	Tipologia	Art.	Metallo	Registrabile			
	Catenaccio e scrocco	48526	Serratura	Deviatori	Tradizionale	Sicurezza	 in dotazione
	Catenaccio e rullo	48551	 06463- 32- 0 per serrature rullo utilizzare inserto 06141.71.0	 06465-42-0 (pz.2)	0E300.	0A3S1.	
	Elettrica con maniglia	18526			41.0.12	41.0.12	



SERRATURE A FASCIA 1 PUNTO DI CHIUSURA

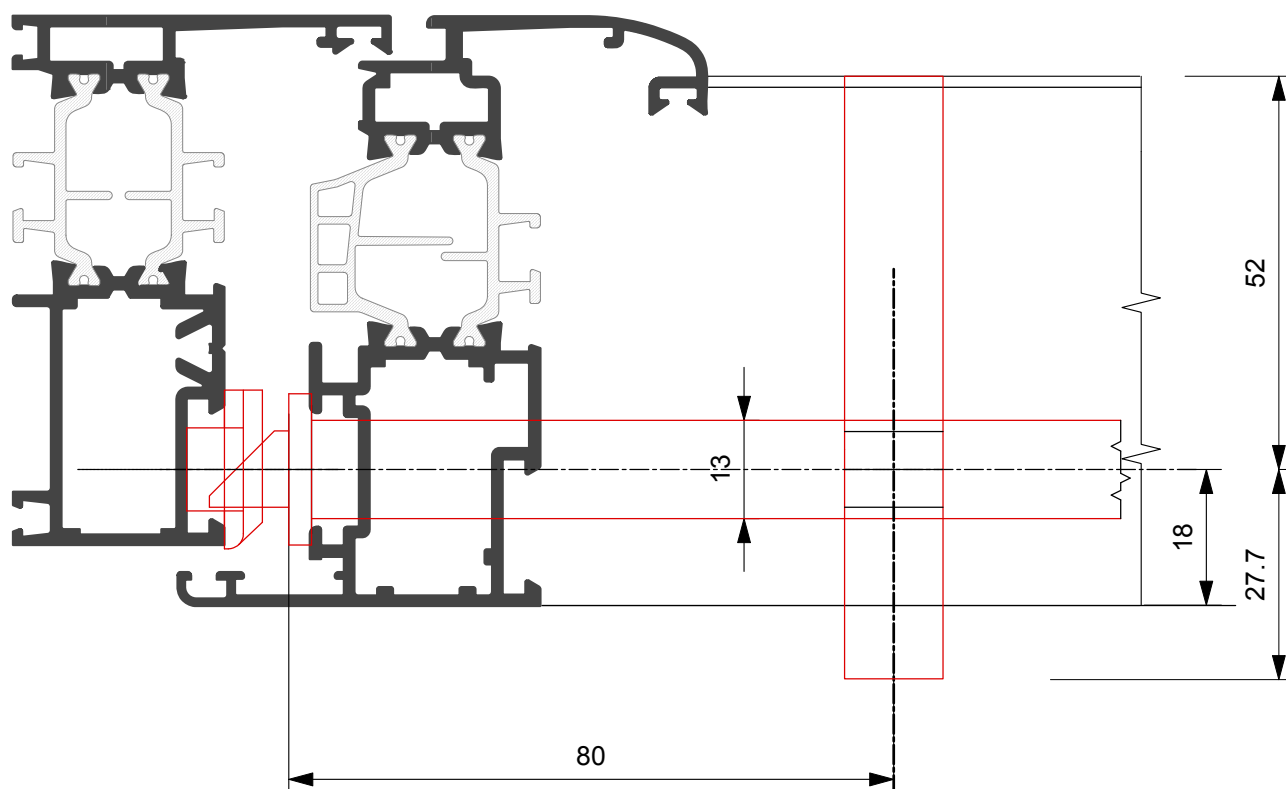

Riferimenti CISA





	Serratura E= 80 mm		Contropiastra		Cilindro	Borchia
	Tipologia	Art	Nylon	Metallo Registrabile		
	Catenaccio e scrocco	44461 44151	06277-89-0	<p>06465 - 21- 0 per serrature rullo utilizzare inserto 06141.71.0</p>	<p>Tradizionale</p>	
	Catenaccio e rullo	44471	06277-90-0			
	Elettrica con maniglia	14451	06287-89-0			

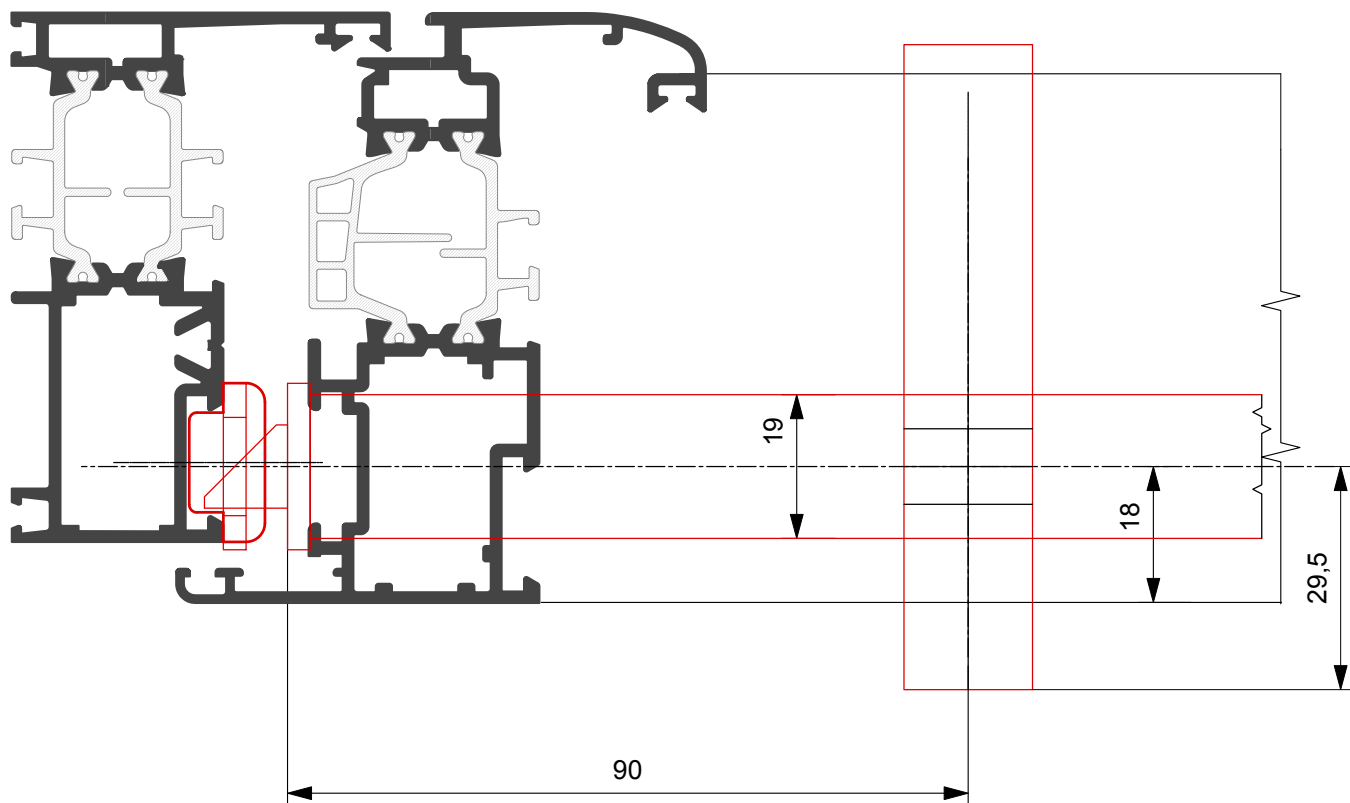

SERRATURE DI SICUREZZA DA FASCIA A CILINDRO 3 PUNTI DI CHIUSURA

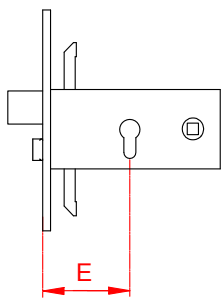

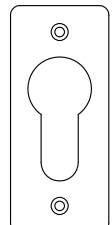
Riferimenti CISA



	Serratura doppia mappa E= 90 mm		Contropiastra		Cilindro		Borchia
	Tipologia	Art	Metallo	Registrabile			
	Catenaccio e scrocco	56357		06465 - 22- 0	Tradizionale	Sicurezza	in dotazione
	Kit rullo	06168.00		per serrature rullo utilizzare inserto 06141.71.0	0E300. 20.0.12	0A3S1. 20.0.12	

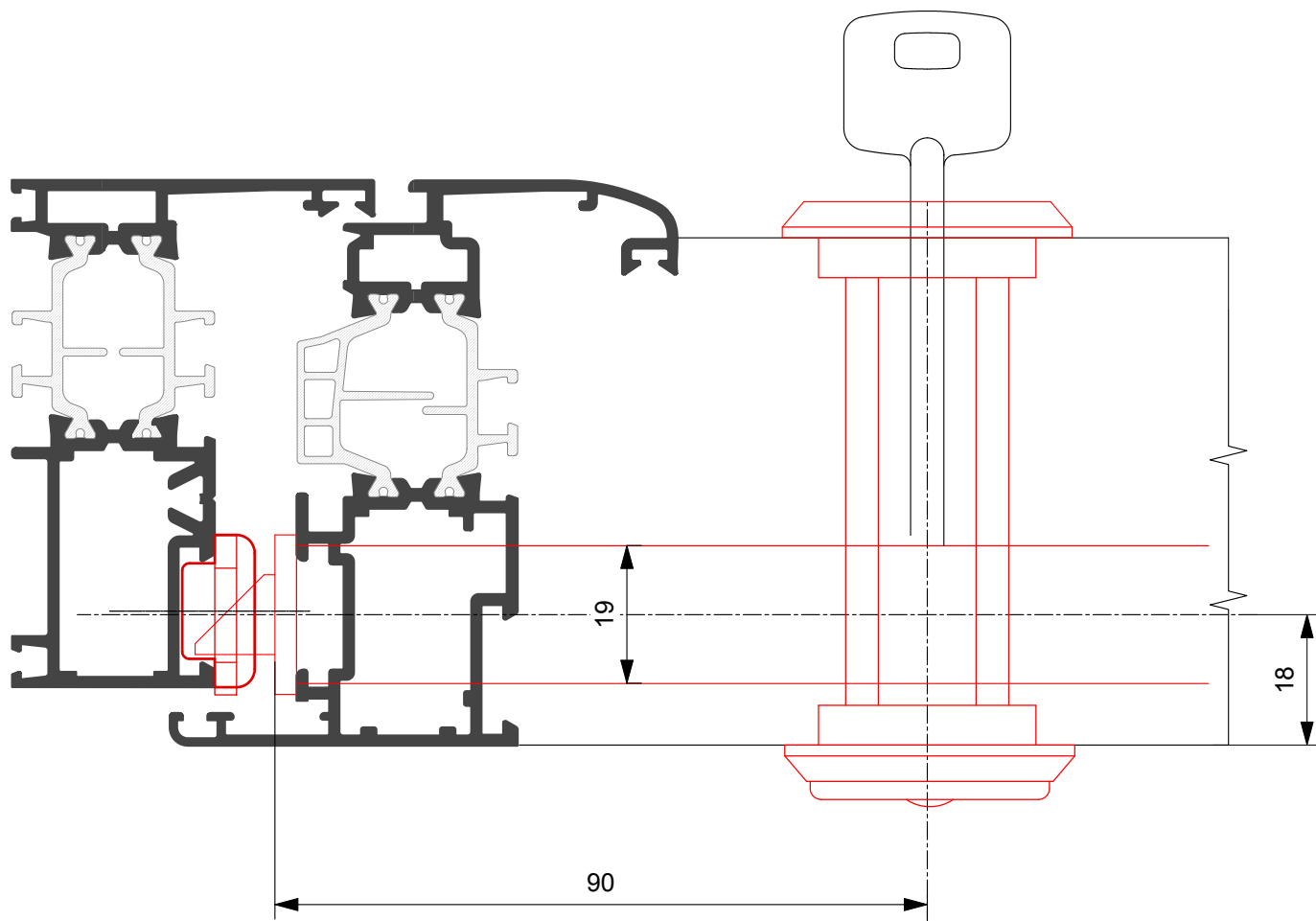

SERRATURE DI SICUREZZA DA FASCIA A DOPPIA MAPPA 3 PUNTI DI CHIUSURA

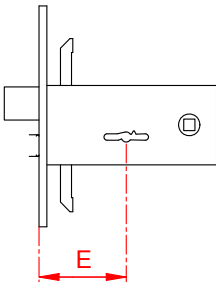

Riferimenti CISA

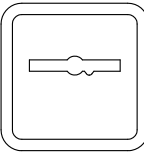



	Serratura Doppia Mappa E= 90 mm		Contropiastra	Borchia
	Tipologia	Art	Metallo Registrabile	
Catenaccio e scrocco	57357-91-0		06465 - 22- 0 per serrature rullo utilizzare inserto 06141.71.0	 in dotazione
Catenaccio e rullo	57365-91-0			
Elettrica con maniglia	17357-91-0			

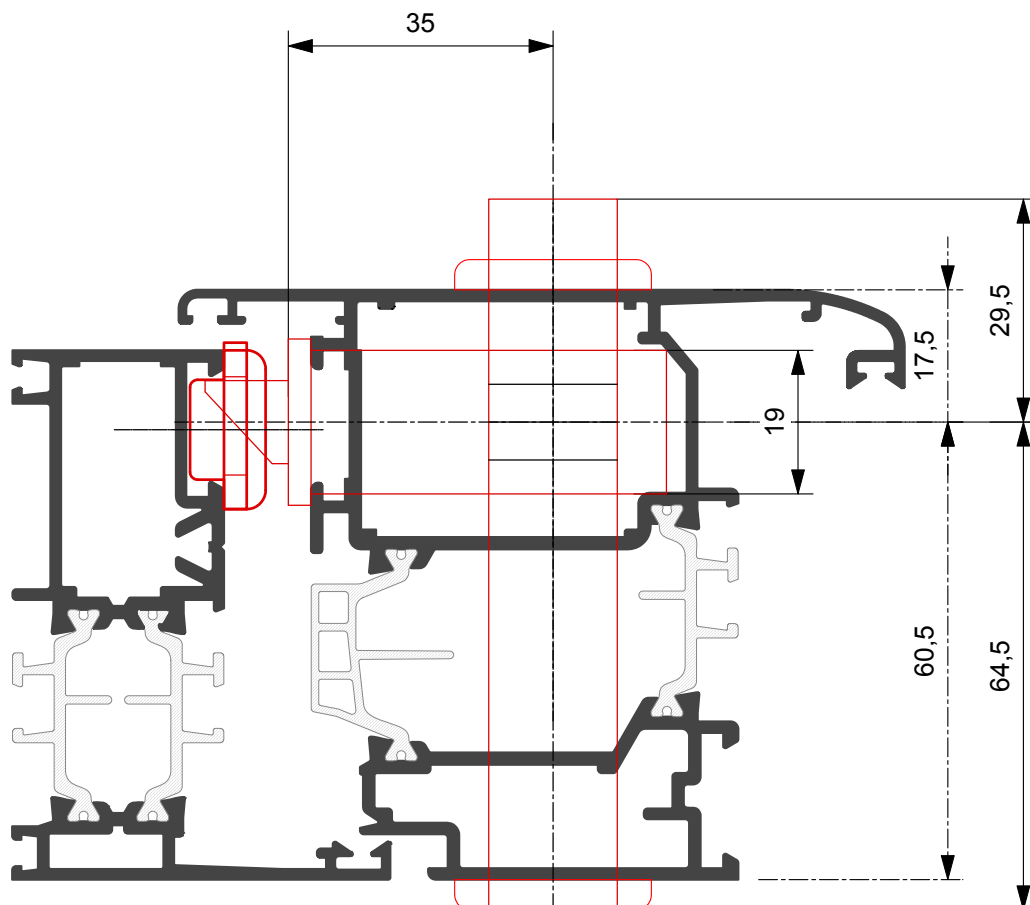

SERRATURE DI SICUREZZA DA MONTANTE 1 PUNTI DI CHIUSURA

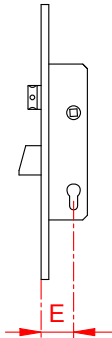

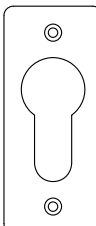
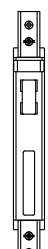
Riferimenti CISA

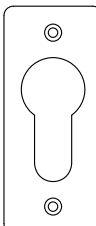
	Serratura E= 35 mm		Contropiastra		Cilindro		Borchia	
	Tipologia	Art.	Metallo	Registrabile	 Tradizionale	 Sicurezza	 in dotazione	
Catenaccio e scrocco	46215		Metallo	Registrabile	 Tradizionale	 Sicurezza		 in dotazione
Catenaccio e rullo	46230						06463 - 22- 0 per serrature rullo utilizzare inserto 06141.71.0	
Elettrica con maniglia	16215							



SERRATURE DI SICUREZZA DA MONTANTE 3 PUNTI DI CHIUSURA - FRONTALE INTERO

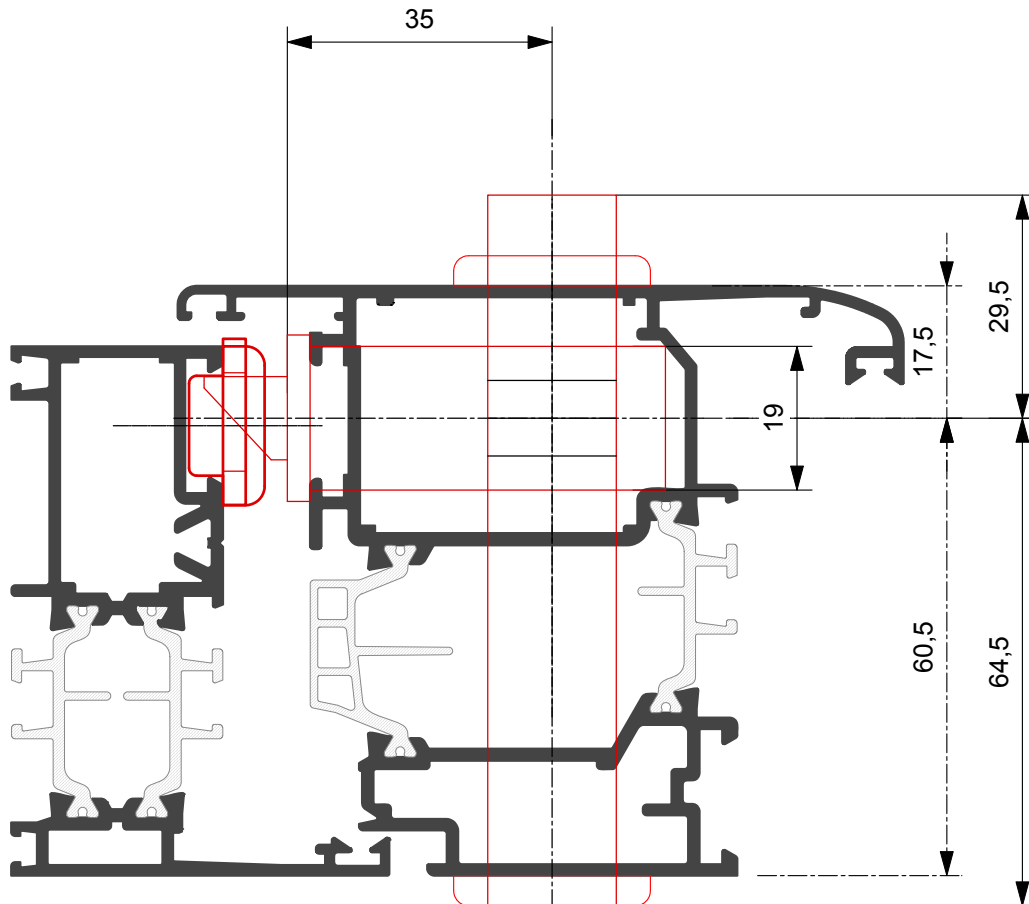

Riferimenti CISA

	Serratura E= 35 mm		Contropiastra		Cilindro		Borchia
	Tipologia	Art.	Metallo	Registrabile			
	Catenaccio e scrocco	48526	Serratura	Deviatori	 Tradizionale	 Sicurezza	 in dotazione
	Catenaccio e rullo	48551	 06463-32-0 per serrature rullo utilizzare inserto 06141.71.0	 06465-42-0 (pz.2)	0E300.	0A3S1.	
	Elettrica con maniglia	18526			41.0.12	41.0.12	



SERRATURE DI SICUREZZA DA MONTANTE 3 PUNTI DI CHIUSURA - FRONTALE INTERO

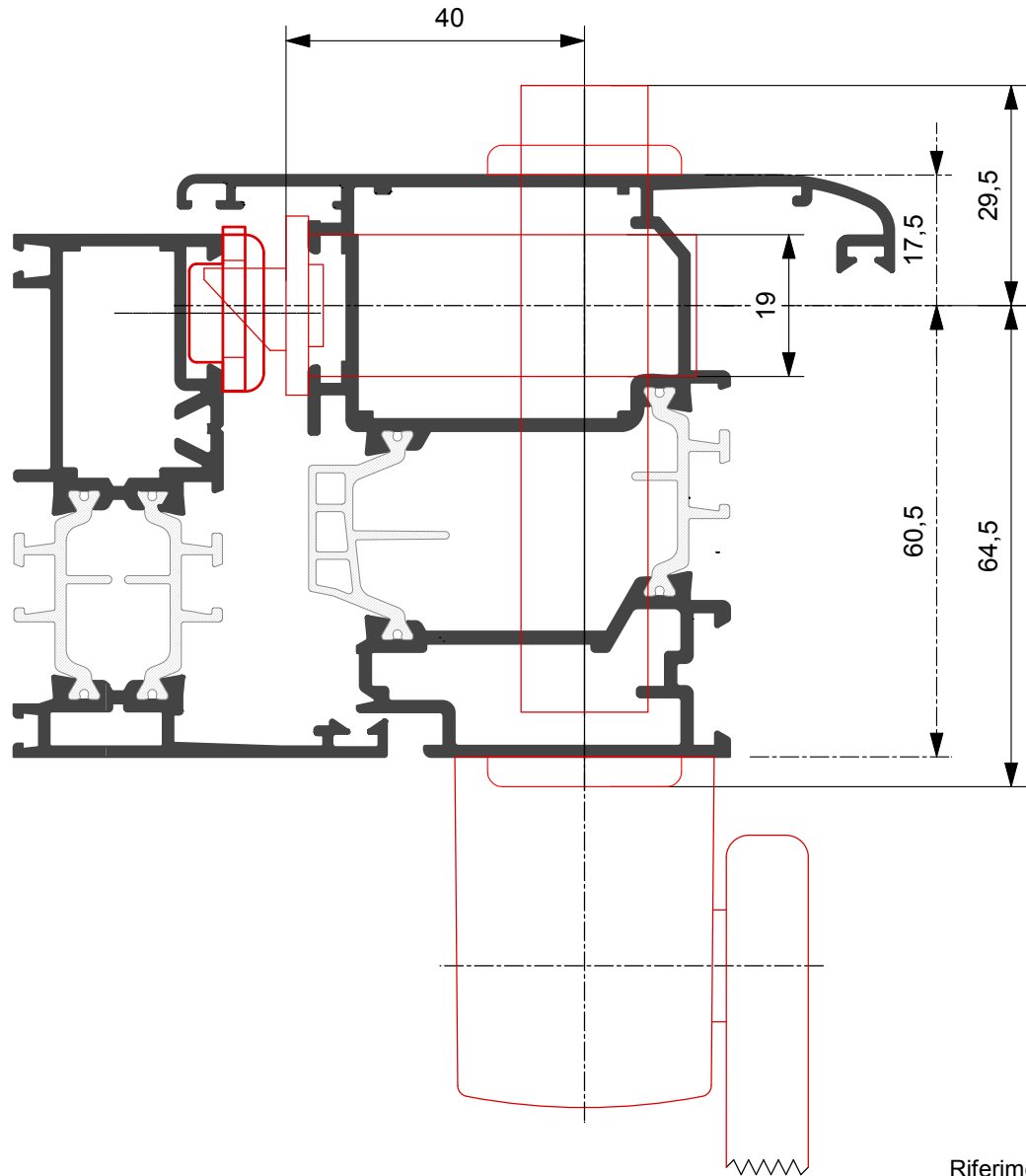

Riferimenti CISA

	Serratura E= 40 mm		Contropiastra		Cilindro		Borchia
	Tipologia	Art.	Metallo	Registrabile			
	Catenaccio e scrocco Fun. A/D	43725	Serratura	Deviatori	Tradizionale	Sicurezza	in dotazione
	Catenaccio e scrocco Fun. B	43735	 06463-32-0 per serrature rullo utilizzare inserto 06141.71.0	 06465-22-0	 0E300.41.0.12	 0A3S1.41.0.12	
	Maniglione	59605.06					
Barra	07007.61						

PAM SYSTEM S.r.L.

S.S. 230 - Fornace Crocicchio 13030 Formigliana (VC)
Tel. 0161 858811 - Fax 0121 858800
www.pamsystemsrl.com | info@pamsystemsrl.com

ALQ GENOVA s.r.l.

Direzione & Magazzino

Via Colano, 9/A 12/K 16162 Genova Bolzaneto (GE)
Tel. 010 7491941 - Fax 010 7450155

Magazzino

Via Meucci, 25 Calenzano 50041 (FI)
Tel. +39 055 8825060 Fax: +39 055 8824916
www.alqsystem.it | info@alqgenovasrl.com

PAESANI GROUP

Direzione & Magazzino

Via del Grano, 260 47822 Santarcangelo di Romagna (RN)
Tel. 0541 748511

www.paesani.com | info@paesani.com

Magazzino Nord

Via Luigi Bonati, 21 29017 Fiorenzuola d'Arda (PC)
Tel. 0523 943138
magazzinonord@paesani.com

DIVA s.a.s

Via Po, 25 - Z.I. Sambuceto 66020 S.Giovanni Teatino (CH)
Tel. 085 4405210 - Fax 085 4405207

www.camel-diva.com | info@camel-diva.com

EUROALL S.r.l.

Strada Comunale della Mola Saracena, 23 00065 Fiano Romano (RM)

Tel. 0765 455228/61 - Fax 0765 455317

www.euroallslrl.it | info@euroallslrl.it

PROFILATI UMBRIA S.r.l.

Via Dei Tigli, 35 - 06083 Bastia Umbra (PG)
Tel. 075 8012385 | 075 8010328 - Fax 075 8012386
info@profilatiumbria.it

TSL ALLUMINIO S.r.l.

Via delle Industrie, 12 00030 San Cesario (Roma)
Tel. 06 2251591 (Ric. Aut.) - Fax 06 2280693
www.tslalluminio.it | info@tslluminio.it

ALLCAR SERVICE S.r.l.

Via Acuto, 120 - 00131 Roma
Tel. 06 4130626 (Ric. Aut.) - Fax 06 4130367
www.allcarservice.it | allcarservice@mclink.it

ALLUCOM S.r.l.

Andria

Via Vecchia Barletta 237 Z. Ind. - 76123 Andria (BT)
Tel. 0883 592213 - Fax 0883 552386

Bari

Via Zippitelli, 28/B - 70123 (BA)
Tel. 0805058608 - Fax 0805058607
www.allucom.com | info@allucom.com

CARUSO S.r.l.

Z.I. Contrada Le Macere 86019 Vinchiaturio (CB)
Tel. 0874 340024 - Fax 0874340025
carusosrl1@libero.it

CAIMAR S.n.c.

Direzione & Magazzino

Strada Prov.le Rimedio-Torregrande Km. 4
09072 Cabras (OR) - Tel. 0783 290118

Filiale

Fronte S.S. 131 Km. 17,450 - 09023 Monastir (CA)
Tel. 070 9166020 - Fax 070 9166191
www.caimar.it | caimarmail@caimar.it

SALENTO METALLI S.r.l.

Via Federico II, 13 - Zona PIP - 73020 Cavallino (LE)
Tel. 0832 614576 - Fax 0832 614635
www.salentometalli.it | info@salentometalli.it

MIDA ALLUMINIO S.r.l.

Napoli

Via Piano del Principe, 36
80047 San Giuseppe Vesuviano (NA)
Tel. 081 5297373 - Fax 081 8284449

Salerno

Loc. Terzerie, Z.I. - 80061 Ogliastro Cilento (SA)
Tel. 0974 833233 - Fax 0974 844724
www.gruppomida.it | info@gruppomida.it

ITALBACOLOR S.r.l.

C.da Valle S. Maria - 87024 Fuscaldo (CS)
Tel. 0982 618025 - Fax 0982 720235
www.italbacolor.it | commerciale@italbacolor.it

COMAS S.r.l.

Via Porta Palermo, 84 - 91011 Alcamo (TP)
Tel. 0924 507050 - Fax 0924 507051
www.comasgroup.it | info@comasgroup.it

ALUK TIM

Aluk Tim D.o.o.

Žegoti 10, 51215 Kastav Croazia, UE
Tel: +385 (0) 51/691 461 - Fax: +385 (0) 51/691 473

Filiale di Zagabria

Franje Lučića, 34A Zagabria Croazia, UE
Tel: +385 (0) 1 6462 611 - Fax: +385 (0) 1 6462 610
Mob: +385 (0) 99 2939656

zagreb@aluk.hr

Filiale Spalato

Street Sv. Nikole Tavelića, 13A 21204
Dugopolje Croazia, UE
Tel: +385 (0) 21225525
Fax: +385 (0) 21660110
Mob: +385 (0) 99 2199228
split@aluk.hr



  www.twinsystems.it
info@twinsystems.it

Consorzio TWIN SYSTEMS

Via delle Macere, 20 | 00060 Formello [Roma]
Tel./Fax 06 23260298